

ADM1810 to ADM1813/ADM1815 to ADM1818

FEATURES

Reliable low cost voltage monitor with reset output

Suitable for monitoring 2.5 V, 3 V, 3.3 V, and 5 V power supply voltages

Reset threshold levels: 4.62 V, 4.35 V, 3.06 V, 2.88 V, 2.55 V, 2.31 V, and 2.18 V typical

Active high and low push-pull output choices: ADM1810, ADM1812, ADM1815, and ADM1817

Open-drain output choices: ADM1811, ADM1813, ADM1816, and ADM1818

Can be used with a manual push-button to generate a reset: ADM1813, ADM1818

Initialization of microprocessor systems with added safety
Available in 3-lead SOT-23 and SC70 packages

APPLICATIONS

Microprocessor systems

Computers

Controllers

Intelligent instruments

Automotive systems

GENERAL DESCRIPTION

The ADM181x range of voltage monitoring circuits is used in any application where an electronic system needs to be reset when a voltage increases above or below a predetermined value.

Because of the reset delay time incorporated into the ADM181x series, these devices provide a safe startup for electronic systems. Before a system initializes, the power supply must stabilize.

Using the ADM181x series ensures that there are typically 150 ms for the power supply to stabilize before the system resets and safe system initialization begins.

The ADM181x series of microprocessor reset circuits are available in low cost, space-saving SOT-23 and SC70 packages.

FUNCTIONAL BLOCK DIAGRAMS

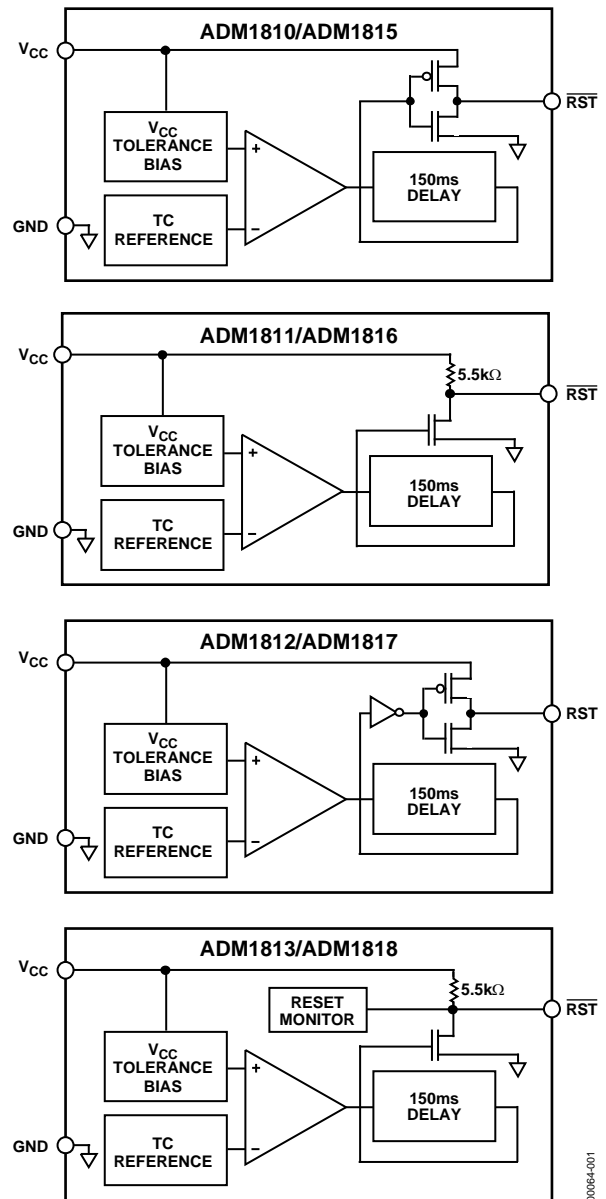

Figure 1.

Rev. E

Information furnished by Analog Devices is believed to be accurate and reliable. However, no responsibility is assumed by Analog Devices for its use, nor for any infringements of patents or other rights of third parties that may result from its use. Specifications subject to change without notice. No license is granted by implication or otherwise under any patent or patent rights of Analog Devices. Trademarks and registered trademarks are the property of their respective owners.

ADM1810 to ADM1813/ADM1815 to ADM1818

TABLE OF CONTENTS

Features	1
Applications.....	1
General Description	1
Functional Block Diagrams.....	1
Revision History	2
Specifications.....	3
Absolute Maximum Ratings.....	4
ESD Caution.....	4
Pin Configurations and Function Descriptions	5

REVISION HISTORY

8/08—Rev. D to Rev. E

Changes to Table 3.....	5
Updated Outline Dimensions	8
Changes to Ordering Guide	9

10/05—Rev. C to Rev. D

Updated Format.....	Universal
Added Figure 3.....	5
Changes to Table 3.....	5
Updated Outline Dimensions	8
Editsto Ordering Guide	9

9/03—Rev. B to Rev. C.

Added SC70.....	Universal
Edits to Specifications	2
Edits to Ordering Guide	4
Updated Outline Dimensions	7

Typical Performance Characteristics	6
Theory of Operation.....	7
Timing Diagrams for All Devices	7
ADM1813 and ADM1818.....	7
ADM1810, ADM1812, ADM1815, and ADM1817	7
ADM1811 and ADM1816.....	7
Outline Dimensions	8
Ordering Guide	9

2/03—Rev. A to Rev. B.

Edits to Features.....	1
Deleted Table I	1
Edits to Specifications.....	2
Edits to Absolute Maximum Ratings.....	3
Edits to Ordering Guide	3
Added Typical Performance Characteristics	4
Edits to ADM1813 AND ADM1818 section	5
Edits to ADM1810, ADM1812, ADM1815, and ADM1817 Section	5
Edits to ADM1811 and ADM1816 Section	5
Updated Outline Dimensions.....	6

3/02—Rev. 0 to Rev. A.

Addition of Table	1
Edits to Ordering Guide	3
Addition of New Text to ADM1813 and ADM1818 Section	4

4/99—Rev.0: Initial Version

ADM1810 to ADM1813/ADM1815 to ADM1818

SPECIFICATIONS

V_{CC} = full operating range, T_A = -40°C to $+105^{\circ}\text{C}$, unless otherwise noted.

Table 1.

Parameter	Min	Typ	Max	Unit	Comments
SUPPLY					
Voltage	1		5.5	V	$T_A = 0^{\circ}\text{C}$ to 105°C
	1.2		5.5	V	$T_A = -40^{\circ}\text{C}$ to $+105^{\circ}\text{C}$
Current		9	16	μA	$V_{CC} = 5.5\text{ V}$, $V_{CC} > V_{TH}$, no load
		4	10	μA	$V_{CC} = 3.6\text{ V}$, $V_{CC} > V_{TH}$, no load
OUTPUT CURRENT					
$\overline{\text{RST}}$ Output Source Current		350		μA	$V_{CC} \geq V_{TH}$ (max), reset not asserted (ADM1810/ADM1815)
RST Output Source Current		350		μA	$V_{CC} \leq V_{TH}$ (min), reset asserted (ADM1812/ADM1817)
$\overline{\text{RST}}$ Output Sink Current	8			mA	$V_{CC} \geq 2.7\text{ V}$, reset asserted, $V_{OUT} = 0.4\text{ V}$ (ADM1810/ADM1811/ADM1813/ADM1815/ADM1816/ ADM1818)
RST Output Sink Current	8			mA	$V_{CC} \geq 2.7\text{ V}$, reset not asserted, $V_{OUT} = 0.4\text{ V}$ (ADM1812/ADM1817)
OUTPUT VOLTAGE					
	$V_{CC} - 0.5$	$V_{CC} - 0.1$		V	ADM1810/ADM1812/ADM1815/ADM1817 @ $0\ \mu\text{A}$ to $500\ \mu\text{A}$
V_{CC} TRIP POINT					
ADM1810-5, ADM1811-5, ADM1812-5, ADM1813-5	4.50	4.62	4.75	V	
ADM1810-10, ADM1811-10, ADM1812-10, ADM1813-10	4.25	4.35	4.49	V	
ADM1815-5, ADM1816-5, ADM1817-5, ADM1818-5	2.98	3.06	3.15	V	
ADM1815-10, ADM1816-10, ADM1817-10, ADM1818-10	2.80	2.88	2.97	V	
ADM1815-20, ADM1816-20, ADM1817-20, ADM1818-20	2.47	2.55	2.64	V	
ADM1815-R23, ADM1816-R23, ADM1817-R23, ADM1818-R23	2.25	2.31	2.37	V	
ADM1815-R22, ADM1816-R22, ADM1817-R22, ADM1818-R22	2.12	2.18	2.25	V	
INTERNAL PULL-UP RESISTOR					
ADM1811/ADM1816	3.5	5.5	7.5	k Ω	
ADM1813/ADM1818	3.1	5.5	7.5	k Ω	
OUTPUT CAPACITANCE					
			10	pF	
RESET ACTIVE TIME					
	100	150	250	ms	
V_{CC} DETECT TO RESET					
Falling		10		μs	
Rising	100	150	250	ms	$t_R = 5\ \mu\text{s}$
PUSH-BUTTON DETECT TO $\overline{\text{RST}}$					
	1			μs	(ADM1813/ADM1818)
PUSH-BUTTON RESET					
	100	150	250	ms	(ADM1813/ADM1818)

ADM1810 to ADM1813/ADM1815 to ADM1818

ABSOLUTE MAXIMUM RATINGS

T_A = 25°C, unless otherwise noted.

Table 2.

Parameter	Rating
V _{CC}	-0.3 V to +6.0 V
Input Current	20 mA
Operating Temperature Range	-40°C to +105°C
Storage Temperature Range	-65°C to +150°C
θ _{JA} Thermal Impedance, SOT-23	270°C/W
θ _{JA} Thermal Impedance, SC70	146°C/W
Lead Temperature (Soldering, 10 sec)	300°C
Vapor Phase (60 sec)	215°C
Infrared (15 sec)	220°C

Stresses above those listed under Absolute Maximum Ratings may cause permanent damage to the device. This is a stress rating only; functional operation of the device at these or any other conditions above those indicated in the operational section of this specification is not implied. Exposure to absolute maximum rating conditions for extended periods may affect device reliability.

ESD CAUTION



ESD (electrostatic discharge) sensitive device. Charged devices and circuit boards can discharge without detection. Although this product features patented or proprietary protection circuitry, damage may occur on devices subjected to high energy ESD. Therefore, proper ESD precautions should be taken to avoid performance degradation or loss of functionality.

PIN CONFIGURATIONS AND FUNCTION DESCRIPTIONS

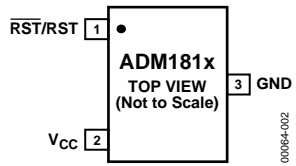

Figure 2. 3-Lead SOT-23 Pin Configuration

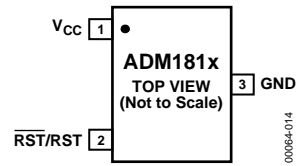

Figure 3. 3-Lead SC70 Pin Configuration

Table 3. Pin Function Descriptions

Pin No.		Mnemonic	Function
SOT-23	SC70		
1	2	RST	Active High Reset Output. RST remains high while V _{CC} is below the reset threshold and remains high for 150 ms typical after V _{CC} rises above the reset threshold. Applies to the ADM1812 and ADM1817 only. Active Low Reset Output. $\overline{\text{RST}}$ remains low while V _{CC} is below the reset threshold and remains low for 150 ms typical after V _{CC} rises above the reset threshold. Applies to the ADM1810, ADM1811, ADM1813, ADM1815, ADM1816, and ADM1818 only.
		$\overline{\text{RST}}$	
2	1	V _{CC}	Supply Voltage. The supply voltage being monitored.
3	3	GND	Ground. 0 V ground reference for all signals.

ADM1810 to ADM1813/ADM1815 to ADM1818

TYPICAL PERFORMANCE CHARACTERISTICS

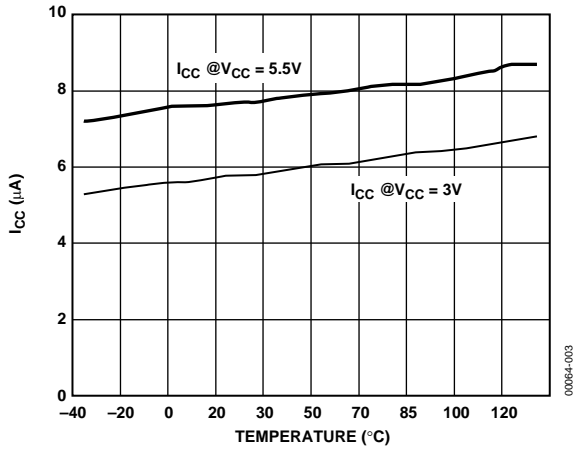

Figure 4. Supply Current vs. Temperature



Figure 7. Normalized Reset Threshold vs. Temperature

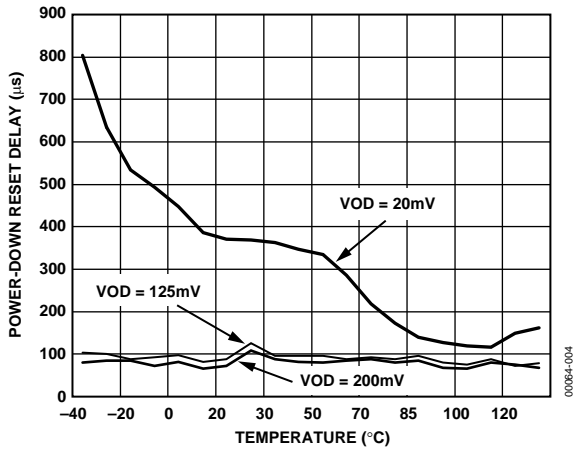

Figure 5. Power-Down Reset Delay vs. Temperature



Figure 8. Maximum Transient Duration Without Causing a Reset Pulse vs. Reset Comparator Overdrive

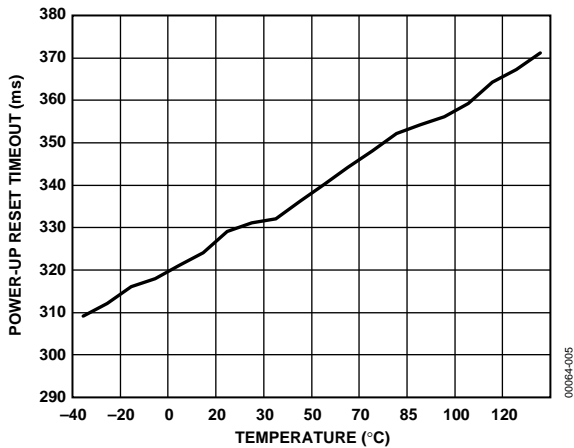

Figure 6. Power-Up Reset Timeout vs. Temperature

THEORY OF OPERATION

TIMING DIAGRAMS FOR ALL DEVICES

The following two timing diagrams are valid for ADM1810, ADM1811, ADM1812, ADM1813, ADM1815, ADM1816, ADM1817, and ADM1818.



Figure 9. Power-Down Timing Diagram



Figure 10. Power-Up Timing Diagram

ADM1813 AND ADM1818

The ADM1813 and ADM1818 are low cost voltage monitoring devices featuring an open-drain output and optional push-button reset function.



Figure 11. ADM1813/ADM1818 Typical Application

An optional push-button reset switch can be connected between RST and ground. Pressing this switch pulls the reset output low. If the push-button reset button pulls the RST output low for a period greater than 1 μ s when the reset button releases the RST line to float high, then the RST line stays low for another 150 ms typical.



Figure 12. Push-Button Reset Timing Diagram

The ADM1818 range has 2.88 V and 2.55 V (typical) trip point options that allow the user to monitor 3.3 V and 3 V supplies. For 5 V monitoring requirements, the ADM1813 range has 4.62 V and 4.35 V (typical) trip point options.

ADM1810, ADM1812, ADM1815, AND ADM1817

The ADM1812 is a 5 V supply monitor with an active high push-pull output and trip point options of 4.62 V and 4.35 V typical. The ADM1810 is similar to the ADM1812, except that the ADM1810 has an active low push-pull output stage. The ADM1817 is suitable for monitoring 3.3 V, 3 V, and 2.5 V supplies, with an active high push-pull output and trip point options of 3.06 V, 2.88 V, 2.55 V, 2.31 V, and 2.18 V typical. The ADM1815 is similar to the ADM1817, except that the ADM1815 has an active low push-pull output stage.

The ADM1810/ADM1812/ADM1815/ADM1817 can connect directly to most microprocessor reset inputs without the need for external components.

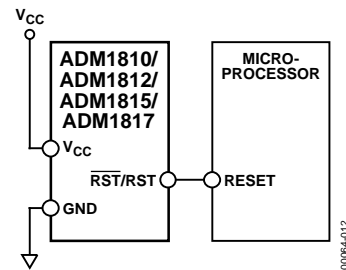

Figure 13. ADM1810/ADM1812/ADM1815/ADM1817 Typical Application

ADM1811 AND ADM1816

The ADM1811 is a 5 V supply monitor with an active low open-drain output and trip point options of 4.62 V and 4.35 V typical. The ADM1816 also has an active low open-drain output but is suitable for monitoring lower voltage supplies of 3.3 V, 3 V, and 2.5 V.

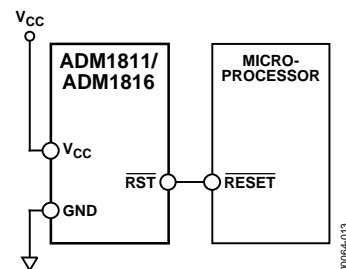

Figure 14. ADM1811/ADM1816 Typical Application

ADM1810 to ADM1813/ADM1815 to ADM1818

OUTLINE DIMENSIONS



COMPLIANT TO JEDEC STANDARDS TO-236-AB

Figure 15. 3-Lead Small Outline Transistor Package [SOT-23] (RT-3)

Dimensions shown in millimeters

092707-A

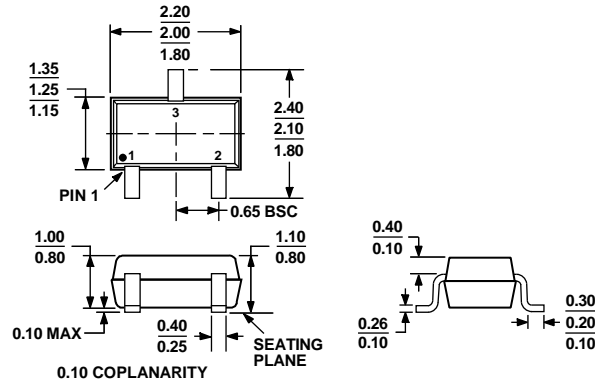

ALL DIMENSIONS COMPLIANT WITH EIAJ SC70

Figure 16. 3-Lead Thin Shrink Small Outline Transistor Package [SC70] (KS-3)

Dimensions shown in millimeters

111505-0

ADM1810 to ADM1813/ADM1815 to ADM1818

ORDERING GUIDE

Model ¹	Temperature Range	Trip Point	Package Option	Branding
ADM1810-5AKS-REEL	-40°C to +105°C	4.62 V	KS-3 (SC70)	MZV
ADM1810-5AKS-RL7	-40°C to +105°C	4.62 V	KS-3 (SC70)	MZV
ADM1810-5AKSZ-REEL ²	-40°C to +105°C	4.62 V	KS-3 (SC70)	M4Y
ADM1810-5AKSZ-RL7 ²	-40°C to +105°C	4.62 V	KS-3 (SC70)	M4Y
ADM1810-5ART-REEL	-40°C to +105°C	4.62 V	RT-3 (SOT-23)	MZV
ADM1810-5ART-REEL7	-40°C to +105°C	4.62 V	RT-3 (SOT-23)	MZV
ADM1810-5ARTZ-REEL ²	-40°C to +105°C	4.62 V	RT-3 (SOT-23)	M4Y
ADM1810-5ARTZ-RL7 ²	-40°C to +105°C	4.62 V	RT-3 (SOT-23)	M4Y
ADM1810-10AKS-REEL	-40°C to +105°C	4.35 V	KS-3 (SC70)	MZT
ADM1810-10AKS-RL7	-40°C to +105°C	4.35 V	KS-3 (SC70)	MZT
ADM1810-10AKSZ-RL ²	-40°C to +105°C	4.35 V	KS-3 (SC70)	M4Z
ADM1810-10AKSZ-RL7 ²	-40°C to +105°C	4.35 V	KS-3 (SC70)	M4Z
ADM1810-10ART-REEL	-40°C to +105°C	4.35 V	RT-3 (SOT-23)	MZT
ADM1810-10ART-RL7	-40°C to +105°C	4.35 V	RT-3 (SOT-23)	MZT
ADM1810-10ARTZ-RL ²	-40°C to +105°C	4.35 V	RT-3 (SOT-23)	M4Z
ADM1810-10ARTZ-RL7 ²	-40°C to +105°C	4.35 V	RT-3 (SOT-23)	M4Z
ADM1811-5AKS-REEL	-40°C to +105°C	4.62 V	KS-3 (SC70)	M1V
ADM1811-5AKS-RL7	-40°C to +105°C	4.62 V	KS-3 (SC70)	M1V
ADM1811-5AKSZ-REEL ²	-40°C to +105°C	4.62 V	KS-3 (SC70)	M6Z
ADM1811-5AKSZ-RL7 ²	-40°C to +105°C	4.62 V	KS-3 (SC70)	M6Z
ADM1811-5ART-REEL	-40°C to +105°C	4.62 V	RT-3 (SOT-23)	M1V
ADM1811-5ART-REEL7	-40°C to +105°C	4.62 V	RT-3 (SOT-23)	M1V
ADM1811-5ARTZ-REEL ²	-40°C to +105°C	4.62 V	RT-3 (SOT-23)	M6Z
ADM1811-5ARTZ-RL7 ²	-40°C to +105°C	4.62 V	RT-3 (SOT-23)	M6Z
ADM1811-10AKS-REEL	-40°C to +105°C	4.35 V	KS-3 (SC70)	M1T
ADM1811-10AKS-RL7	-40°C to +105°C	4.35 V	KS-3 (SC70)	M1T
ADM1811-10AKSZ-RL ²	-40°C to +105°C	4.35 V	KS-3 (SC70)	M70
ADM1811-10AKSZ-RL7 ²	-40°C to +105°C	4.35 V	KS-3 (SC70)	M70
ADM1811-10ART-REEL	-40°C to +105°C	4.35 V	RT-3 (SOT-23)	M1T
ADM1811-10ART-RL7	-40°C to +105°C	4.35 V	RT-3 (SOT-23)	M1T
ADM1811-10ARTZ-RL ²	-40°C to +105°C	4.35 V	RT-3 (SOT-23)	M70
ADM1811-10ARTZ-RL7 ²	-40°C to +105°C	4.35 V	RT-3 (SOT-23)	M70
ADM1812-5AKS-REEL	-40°C to +105°C	4.62 V	KS-3 (SC70)	MTV
ADM1812-5AKS-RL7	-40°C to +105°C	4.62 V	KS-3 (SC70)	MTV
ADM1812-5AKSZ-REEL ²	-40°C to +105°C	4.62 V	KS-3 (SC70)	M72
ADM1812-5AKSZ-RL7 ²	-40°C to +105°C	4.62 V	KS-3 (SC70)	M72
ADM1812-5ART-REEL	-40°C to +105°C	4.62 V	RT-3 (SOT-23)	MTV
ADM1812-5ART-REEL7	-40°C to +105°C	4.62 V	RT-3 (SOT-23)	MTV
ADM1812-5ARTZ-REEL ²	-40°C to +105°C	4.62 V	RT-3 (SOT-23)	M72
ADM1812-5ARTZ-RL7 ²	-40°C to +105°C	4.62 V	RT-3 (SOT-23)	M72
ADM1812-10AKS-REEL	-40°C to +105°C	4.35 V	KS-3 (SC70)	MTT
ADM1812-10AKS-RL7	-40°C to +105°C	4.35 V	KS-3 (SC70)	MTT
ADM1812-10AKSZ-RL ²	-40°C to +105°C	4.35 V	KS-3 (SC70)	M71
ADM1812-10AKSZ-RL7 ²	-40°C to +105°C	4.35 V	KS-3 (SC70)	M71
ADM1812-10ART-REEL	-40°C to +105°C	4.35 V	RT-3 (SOT-23)	MTT
ADM1812-10ART-RL7	-40°C to +105°C	4.35 V	RT-3 (SOT-23)	MTT
ADM1812-10ARTZ-RL ²	-40°C to +105°C	4.35 V	RT-3 (SOT-23)	M71
ADM1812-10ARTZ-RL7 ²	-40°C to +105°C	4.35 V	RT-3 (SOT-23)	M71

ADM1810 to ADM1813/ADM1815 to ADM1818

Model ¹	Temperature Range	Trip Point	Package Option	Branding
ADM1813-5AKS-REEL	-40°C to +105°C	4.62 V	KS-3 (SC70)	M3V
ADM1813-5AKS-RL7	-40°C to +105°C	4.62 V	KS-3 (SC70)	M3V
ADM1813-5AKSZ-REEL ²	-40°C to +105°C	4.62 V	KS-3 (SC70)	M6X
ADM1813-5AKSZ-RL7 ²	-40°C to +105°C	4.62 V	KS-3 (SC70)	M6X
ADM1813-5ART-RL	-40°C to +105°C	4.62 V	RT-3 (SOT-23)	M3V
ADM1813-5ART-RL7	-40°C to +105°C	4.62 V	RT-3 (SOT-23)	M3V
ADM1813-5ARTZ-RL ²	-40°C to +105°C	4.62 V	RT-3 (SOT-23)	M6X
ADM1813-5ARTZ-RL7 ²	-40°C to +105°C	4.62 V	RT-3 (SOT-23)	M6X
ADM1813-10AKS-REEL	-40°C to +105°C	4.35 V	KS-3 (SC70)	M3T
ADM1813-10AKS-RL7	-40°C to +105°C	4.35 V	KS-3 (SC70)	M3T
ADM1813-10AKSZ-RL ²	-40°C to +105°C	4.35 V	KS-3 (SC70)	M6Y
ADM1813-10AKSZ-RL7 ²	-40°C to +105°C	4.35 V	KS-3 (SC70)	M6Y
ADM1813-10ART-REEL	-40°C to +105°C	4.35 V	RT-3 (SOT-23)	M3T
ADM1813-10ART-RL7	-40°C to +105°C	4.35 V	RT-3 (SOT-23)	M3T
ADM1813-10ARTZ-RL ²	-40°C to +105°C	4.35 V	RT-3 (SOT-23)	M6Y
ADM1813-10ARTZ-RL7 ²	-40°C to +105°C	4.35 V	RT-3 (SOT-23)	M6Y
ADM1815-5AKS-REEL	-40°C to +105°C	3.06 V	KS-3 (SC70)	M5K
ADM1815-5AKS-RL7	-40°C to +105°C	3.06 V	KS-3 (SC70)	M5K
ADM1815-5AKSZ-REEL ²	-40°C to +105°C	3.06 V	KS-3 (SC70)	M73
ADM1815-5AKSZ-RL7 ²	-40°C to +105°C	3.06 V	KS-3 (SC70)	M73
ADM1815-5ART-REEL	-40°C to +105°C	3.06 V	RT-3 (SOT-23)	M5K
ADM1815-5ART-REEL7	-40°C to +105°C	3.06 V	RT-3 (SOT-23)	M5K
ADM1815-5ARTZ-REEL ²	-40°C to +105°C	3.06 V	RT-3 (SOT-23)	M73
ADM1815-5ARTZ-RL7 ²	-40°C to +105°C	3.06 V	RT-3 (SOT-23)	M73
ADM1815-10AKS-REEL	-40°C to +105°C	2.88 V	KS-3 (SC70)	M5E
ADM1815-10AKS-RL7	-40°C to +105°C	2.88 V	KS-3 (SC70)	M5E
ADM1815-10AKSZ-RL ²	-40°C to +105°C	2.88 V	KS-3 (SC70)	M4F
ADM1815-10AKSZ-RL7 ²	-40°C to +105°C	2.88 V	KS-3 (SC70)	M4F
ADM1815-10ART-REEL	-40°C to +105°C	2.88 V	RT-3 (SOT-23)	M5E
ADM1815-10ART-RL7	-40°C to +105°C	2.88 V	RT-3 (SOT-23)	M5E
ADM1815-10ARTZ-RL ²	-40°C to +105°C	2.88 V	RT-3 (SOT-23)	M4F
ADM1815-10ARTZ-RL7 ²	-40°C to +105°C	2.88 V	RT-3 (SOT-23)	M4F
ADM1815-20AKS-REEL	-40°C to +105°C	2.55 V	KS-3 (SC70)	M5A
ADM1815-20AKS-RL7	-40°C to +105°C	2.55 V	KS-3 (SC70)	M5A
ADM1815-20AKSZ-RL ²	-40°C to +105°C	2.55 V	KS-3 (SC70)	M76
ADM1815-20AKSZ-RL7 ²	-40°C to +105°C	2.55 V	KS-3 (SC70)	M76
ADM1815-20ART-RL	-40°C to +105°C	2.55 V	RT-3 (SOT-23)	M5A
ADM1815-20ART-RL7	-40°C to +105°C	2.55 V	RT-3 (SOT-23)	M5A
ADM1815-20ARTZ-RL ²	-40°C to +105°C	2.55 V	RT-3 (SOT-23)	M76
ADM1815-20ARTZ-RL7 ²	-40°C to +105°C	2.55 V	RT-3 (SOT-23)	M76
ADM1815-R22AKS-RL	-40°C to +105°C	2.18 V	KS-3 (SC70)	M5B
ADM1815-R22AKS-RL7	-40°C to +105°C	2.18 V	KS-3 (SC70)	M5B
ADM1815-R22AKSZ-RL ²	-40°C to +105°C	2.18 V	KS-3 (SC70)	M74
ADM1815-R22AKSZ-R7 ²	-40°C to +105°C	2.18 V	KS-3 (SC70)	M74
ADM1815-R22ART-RL	-40°C to +105°C	2.18 V	RT-3 (SOT-23)	M5B
ADM1815-R22ART-RL7	-40°C to +105°C	2.18 V	RT-3 (SOT-23)	M5B
ADM1815-R22ARTZ-RL ²	-40°C to +105°C	2.18 V	RT-3 (SOT-23)	M74
ADM1815-R22ARTZ-R7 ²	-40°C to +105°C	2.18 V	RT-3 (SOT-23)	M74
ADM1815-R23AKS-RL	-40°C to +105°C	2.31 V	KS-3 (SC70)	M5C
ADM1815-R23AKS-RL7	-40°C to +105°C	2.31 V	KS-3 (SC70)	M5C
ADM1815-R23AKSZ-RL ²	-40°C to +105°C	2.31 V	KS-3 (SC70)	M75
ADM1815-R23AKSZ-R7 ²	-40°C to +105°C	2.31 V	KS-3 (SC70)	M75

ADM1810 to ADM1813/ADM1815 to ADM1818

Model ¹	Temperature Range	Trip Point	Package Option	Branding
ADM1815-R23ART-RL	-40°C to +105°C	2.31 V	RT-3 (SOT-23)	M5C
ADM1815-R23ART-RL7	-40°C to +105°C	2.31 V	RT-3 (SOT-23)	M5C
ADM1815-R23ARTZ-RL ²	-40°C to +105°C	2.31 V	RT-3 (SOT-23)	M75
ADM1815-R23ARTZ-R7 ²	-40°C to +105°C	2.31 V	RT-3 (SOT-23)	M75
ADM1816-5AKS-REEL	-40°C to +105°C	3.06 V	KS-3 (SC70)	M6K
ADM1816-5AKS-REEL7	-40°C to +105°C	3.06 V	KS-3 (SC70)	M6K
ADM1816-5AKSZ-REEL ²	-40°C to +105°C	3.06 V	KS-3 (SC70)	M77
ADM1816-5AKSZ-RL7 ²	-40°C to +105°C	3.06 V	KS-3 (SC70)	M77
ADM1816-5ART-REEL	-40°C to +105°C	3.06 V	RT-3 (SOT-23)	M6K
ADM1816-5ART-REEL7	-40°C to +105°C	3.06 V	RT-3 (SOT-23)	M6K
ADM1816-5ARTZ-REEL ²	-40°C to +105°C	3.06 V	RT-3 (SOT-23)	M77
ADM1816-5ARTZ-RL7 ²	-40°C to +105°C	3.06 V	RT-3 (SOT-23)	M77
ADM1816-10AKS-REEL	-40°C to +105°C	2.88 V	KS-3 (SC70)	M6E
ADM1816-10AKS-RL7	-40°C to +105°C	2.88 V	KS-3 (SC70)	M6E
ADM1816-10AKSZ-RL ²	-40°C to +105°C	2.88 V	KS-3 (SC70)	M54
ADM1816-10AKSZ-RL7 ²	-40°C to +105°C	2.88 V	KS-3 (SC70)	M54
ADM1816-10ART-REEL	-40°C to +105°C	2.88 V	RT-3 (SOT-23)	M6E
ADM1816-10ART-RL7	-40°C to +105°C	2.88 V	RT-3 (SOT-23)	M6E
ADM1816-10ARTZ-RL ²	-40°C to +105°C	2.88 V	RT-3 (SOT-23)	M54
ADM1816-10ARTZ-RL7 ²	-40°C to +105°C	2.88 V	RT-3 (SOT-23)	M54
ADM1816-20AKS-REEL	-40°C to +105°C	2.55 V	KS-3 (SC70)	M6A
ADM1816-20AKS-RL7	-40°C to +105°C	2.55 V	KS-3 (SC70)	M6A
ADM1816-20AKSZ-RL ²	-40°C to +105°C	2.55 V	KS-3 (SC70)	M6H
ADM1816-20AKSZ-RL7 ²	-40°C to +105°C	2.55 V	KS-3 (SC70)	M6H
ADM1816-20ART-REEL	-40°C to +105°C	2.55 V	RT-3 (SOT-23)	M6A
ADM1816-20ART-RL7	-40°C to +105°C	2.55 V	RT-3 (SOT-23)	M6A
ADM1816-20ARTZ-RL ²	-40°C to +105°C	2.55 V	RT-3 (SOT-23)	M6H
ADM1816-20ARTZ-RL7 ²	-40°C to +105°C	2.55 V	RT-3 (SOT-23)	M6H
ADM1816-20ARTZ-RL7 ²	-40°C to +105°C	2.55 V	RT-3 (SOT-23)	M6H
ADM1816-R22AKS-RL	-40°C to +105°C	2.18 V	KS-3 (SC70)	M6B
ADM1816-R22AKS-RL7	-40°C to +105°C	2.18 V	KS-3 (SC70)	M6B
ADM1816-R22AKSZ-RL ²	-40°C to +105°C	2.18 V	KS-3 (SC70)	M78
ADM1816-R22AKSZ-R7 ²	-40°C to +105°C	2.18 V	KS-3 (SC70)	M78
ADM1816-R22ART-RL	-40°C to +105°C	2.18 V	RT-3 (SOT-23)	M6B
ADM1816-R22ART-RL7	-40°C to +105°C	2.18 V	RT-3 (SOT-23)	M6B
ADM1816-R22ARTZ-RL ²	-40°C to +105°C	2.18 V	RT-3 (SOT-23)	M78
ADM1816-R22ARTZ-R7 ²	-40°C to +105°C	2.18 V	RT-3 (SOT-23)	M78
ADM1816-R23AKS-RL	-40°C to +105°C	2.31 V	KS-3 (SC70)	M6C
ADM1816-R23AKS-RL7	-40°C to +105°C	2.31 V	KS-3 (SC70)	M6C
ADM1816-R23AKSZ-RL ²	-40°C to +105°C	2.31 V	KS-3 (SC70)	M79
ADM1816-R23AKSZ-R7 ²	-40°C to +105°C	2.31 V	KS-3 (SC70)	M79
ADM1816-R23ART-RL	-40°C to +105°C	2.31 V	RT-3 (SOT-23)	M6C
ADM1816-R23ART-RL7	-40°C to +105°C	2.31 V	RT-3 (SOT-23)	M6C
ADM1816-R23ARTZ-RL ²	-40°C to +105°C	2.31 V	RT-3 (SOT-23)	M79
ADM1816-R23ARTZ-R7 ²	-40°C to +105°C	2.31 V	RT-3 (SOT-23)	M79
ADM1817-5AKS-REEL	-40°C to +105°C	3.06 V	KS-3 (SC70)	M7K
ADM1817-5AKS-REEL7	-40°C to +105°C	3.06 V	KS-3 (SC70)	M7K
ADM1817-5AKSZ-REEL ²	-40°C to +105°C	3.06 V	KS-3 (SC70)	M7F
ADM1817-5AKSZ-RL7 ²	-40°C to +105°C	3.06 V	KS-3 (SC70)	M7F
ADM1817-5ART-REEL	-40°C to +105°C	3.06 V	RT-3 (SOT-23)	M7K
ADM1817-5ART-REEL7	-40°C to +105°C	3.06 V	RT-3 (SOT-23)	M7K
ADM1817-5ARTZ-REEL ²	-40°C to +105°C	3.06 V	RT-3 (SOT-23)	M7F
ADM1817-5ARTZ-RL7 ²	-40°C to +105°C	3.06 V	RT-3 (SOT-23)	M7F

ADM1810 to ADM1813/ADM1815 to ADM1818

Model ¹	Temperature Range	Trip Point	Package Option	Branding
ADM1817-10AKS-REEL	-40°C to +105°C	2.88 V	KS-3 (SC70)	M7E
ADM1817-10AKS-RL7	-40°C to +105°C	2.88 V	KS-3 (SC70)	M7E
ADM1817-10AKSZ-RL ²	-40°C to +105°C	2.88 V	KS-3 (SC70)	M7G
ADM1817-10AKSZ-RL7 ²	-40°C to +105°C	2.88 V	KS-3 (SC70)	M7G
ADM1817-10ART-REEL	-40°C to +105°C	2.88 V	RT-3 (SOT-23)	M7E
ADM1817-10ART-RL7	-40°C to +105°C	2.88 V	RT-3 (SOT-23)	M7E
ADM1817-10ARTZ-RL ²	-40°C to +105°C	2.88 V	RT-3 (SOT-23)	M7G
ADM1817-10ARTZ-RL7 ²	-40°C to +105°C	2.88 V	RT-3 (SOT-23)	M7G
ADM1817-20AKS-REEL	-40°C to +105°C	2.55 V	KS-3 (SC70)	M7A
ADM1817-20AKS-RL7	-40°C to +105°C	2.55 V	KS-3 (SC70)	M7A
ADM1817-20AKSZ-RL ²	-40°C to +105°C	2.55 V	KS-3 (SC70)	M7H
ADM1817-20AKSZ-RL7 ²	-40°C to +105°C	2.55 V	KS-3 (SC70)	M7H
ADM1817-20ART-REEL	-40°C to +105°C	2.55 V	RT-3 (SOT-23)	M7A
ADM1817-20ART-RL7	-40°C to +105°C	2.55 V	RT-3 (SOT-23)	M7A
ADM1817-20ARTZ-RL ²	-40°C to +105°C	2.55 V	RT-3 (SOT-23)	M7H
ADM1817-20ARTZ-RL7 ²	-40°C to +105°C	2.55 V	RT-3 (SOT-23)	M7H
ADM1817-R22AKS-RL	-40°C to +105°C	2.18 V	KS-3 (SC70)	M7B
ADM1817-R22AKS-RL7	-40°C to +105°C	2.18 V	KS-3 (SC70)	M7B
ADM1817-R22AKSZ-RL ²	-40°C to +105°C	2.18 V	KS-3 (SC70)	M7J
ADM1817-R22AKSZ-R7 ²	-40°C to +105°C	2.18 V	KS-3 (SC70)	M7J
ADM1817-R22ART-RL	-40°C to +105°C	2.18 V	RT-3 (SOT-23)	M7B
ADM1817-R22ART-RL7	-40°C to +105°C	2.18 V	RT-3 (SOT-23)	M7B
ADM1817-R22ARTZ-RL ²	-40°C to +105°C	2.18 V	RT-3 (SOT-23)	M7J
ADM1817-R22ARTZ-R7 ²	-40°C to +105°C	2.18 V	RT-3 (SOT-23)	M7J
ADM1817-R23AKS-RL	-40°C to +105°C	2.31 V	KS-3 (SC70)	M7C
ADM1817-R23AKS-RL7	-40°C to +105°C	2.31 V	KS-3 (SC70)	M7C
ADM1817-R23AKSZ-RL ²	-40°C to +105°C	2.31 V	KS-3 (SC70)	M7L
ADM1817-R23AKSZ-R7 ²	-40°C to +105°C	2.31 V	KS-3 (SC70)	M7L
ADM1817-R23ART-RL	-40°C to +105°C	2.31 V	RT-3 (SOT-23)	M7C
ADM1817-R23ART-RL7	-40°C to +105°C	2.31 V	RT-3 (SOT-23)	M7C
ADM1817-R23ARTZ-RL ²	-40°C to +105°C	2.31 V	RT-3 (SOT-23)	M7L
ADM1817-R23ARTZ-R7 ²	-40°C to +105°C	2.31 V	RT-3 (SOT-23)	M7L
ADM1818-5AKS-REEL	-40°C to +105°C	3.06 V	KS-3 (SC70)	M8K
ADM1818-5AKS-REEL7	-40°C to +105°C	3.06 V	KS-3 (SC70)	M8K
ADM1818-5AKSZ-REEL ²	-40°C to +105°C	3.06 V	KS-3 (SC70)	M4T
ADM1818-5AKSZ-RL7 ²	-40°C to +105°C	3.06 V	KS-3 (SC70)	M4T
ADM1818-5ART-REEL	-40°C to +105°C	3.06 V	RT-3 (SOT-23)	M8K
ADM1818-5ART-REEL7	-40°C to +105°C	3.06 V	RT-3 (SOT-23)	M8K
ADM1818-5ARTZ-REEL ²	-40°C to +105°C	3.06 V	RT-3 (SOT-23)	M4T
ADM1818-5ARTZ-RL7 ²	-40°C to +105°C	3.06 V	RT-3 (SOT-23)	M4T
ADM1818-10AKS-REEL	-40°C to +105°C	2.88 V	KS-3 (SC70)	M8E
ADM1818-10AKS-RL7	-40°C to +105°C	2.88 V	KS-3 (SC70)	M8E
ADM1818-10AKSZ-RL ²	-40°C to +105°C	2.88 V	KS-3 (SC70)	M7P
ADM1818-10AKSZ-RL7 ²	-40°C to +105°C	2.88 V	KS-3 (SC70)	M7P
ADM1818-10ART-REEL	-40°C to +105°C	2.88 V	RT-3 (SOT-23)	M8E
ADM1818-10ART-RL7	-40°C to +105°C	2.88 V	RT-3 (SOT-23)	M8E
ADM1818-10ARTZ-RL ²	-40°C to +105°C	2.88 V	RT-3 (SOT-23)	M7P
ADM1818-20AKS-REEL	-40°C to +105°C	2.55 V	KS-3 (SC70)	M8A
ADM1818-20AKS-RL7	-40°C to +105°C	2.55 V	KS-3 (SC70)	M8A
ADM1818-20AKSZ-RL ²	-40°C to +105°C	2.55 V	KS-3 (SC70)	M59
ADM1818-20AKSZ-RL7 ²	-40°C to +105°C	2.55 V	KS-3 (SC70)	M59
ADM1818-20ART-REEL	-40°C to +105°C	2.55 V	RT-3 (SOT-23)	M8A

ADM1810 to ADM1813/ADM1815 to ADM1818

Model ¹	Temperature Range	Trip Point	Package Option	Branding
ADM1818-20ART-RL7	-40°C to +105°C	2.55 V	RT-3 (SOT-23)	M8A
ADM1818-20ARTZ-RL ²	-40°C to +105°C	2.55 V	RT-3 (SOT-23)	M59
ADM1818-20ARTZ-RL7 ²	-40°C to +105°C	2.55 V	RT-3 (SOT-23)	M59
ADM1818-R22AKS-RL	-40°C to +105°C	2.18 V	KS-3 (SC70)	M8B
ADM1818-R22AKS-RL7	-40°C to +105°C	2.18 V	KS-3 (SC70)	M8B
ADM1818-R22AKSZ-RL ²	-40°C to +105°C	2.18 V	KS-3 (SC70)	M7M
ADM1818-R22AKSZ-R7 ²	-40°C to +105°C	2.18 V	KS-3 (SC70)	M7M
ADM1818-R22ART-RL	-40°C to +105°C	2.18 V	RT-3 (SOT-23)	M8B
ADM1818-R22ART-RL7	-40°C to +105°C	2.18 V	RT-3 (SOT-23)	M8B
ADM1818-R23AKS-RL	-40°C to +105°C	2.31 V	KS-3 (SC70)	M8C
ADM1818-R23AKS-RL7	-40°C to +105°C	2.31 V	KS-3 (SC70)	M8C
ADM1818-R23AKSZ-RL ²	-40°C to +105°C	2.31 V	KS-3 (SC70)	M7N
ADM1818-R23AKSZ-R7 ²	-40°C to +105°C	2.31 V	KS-3 (SC70)	M7N
ADM1818-R23ART-RL	-40°C to +105°C	2.31 V	RT-3 (SOT-23)	M8C
ADM1818-R23ART-RL7	-40°C to +105°C	2.31 V	RT-3 (SOT-23)	M8C

¹ Available only in reels.

² Z = RoHS Compliant Part.

NOTES

NOTES

NOTES

Данный компонент на территории Российской Федерации

Вы можете приобрести в компании MosChip.

Для оперативного оформления запроса Вам необходимо перейти по данной ссылке:

<http://moschip.ru/get-element>

Вы можете разместить у нас заказ для любого Вашего проекта, будь то серийное производство или разработка единичного прибора.

В нашем ассортименте представлены ведущие мировые производители активных и пассивных электронных компонентов.

Нашей специализацией является поставка электронной компонентной базы двойного назначения, продукции таких производителей как XILINX, Intel (ex.ALTERA), Vicor, Microchip, Texas Instruments, Analog Devices, Mini-Circuits, Amphenol, Glenair.

Сотрудничество с глобальными дистрибьюторами электронных компонентов, предоставляет возможность заказывать и получать с международных складов практически любой перечень компонентов в оптимальные для Вас сроки.

На всех этапах разработки и производства наши партнеры могут получить квалифицированную поддержку опытных инженеров.

Система менеджмента качества компании отвечает требованиям в соответствии с ГОСТ Р ИСО 9001, ГОСТ РВ 0015-002 и ЭС РД 009

Офис по работе с юридическими лицами:

105318, г.Москва, ул.Щербаковская д.3, офис 1107, 1118, ДЦ «Щербаковский»

Телефон: +7 495 668-12-70 (многоканальный)

Факс: +7 495 668-12-70 (доб.304)

E-mail: info@moschip.ru

Skype отдела продаж:

moschip.ru

moschip.ru_4

moschip.ru_6

moschip.ru_9