



Main

Range of product	OsiSense XCC
Encoder type	Incremental encoder
Encoder name	XCC
Product specific application	-
Diameter	2.28 in (58 mm)
Shaft diameter	0.39 in (10 mm)
Shaft type	Solid shaft
Resolution	2500 points
Output stage	Type X
Type of output stage	Driver 5V, RS422
Electrical connection	1 male connector M23 radial 12 pins
[Us] rated supply voltage	4.75...30 V DC
Enclosure material	Zamak

Complementary

Residual ripple	500 mV
Maximum revolution speed	9000 rpm
Shaft moment of inertia	0 lb.in ² (10 g.cm ²)
Torque value	0.04 lbf.in (0.004 N.m)
Maximum load	10 daN radial 5 daN axial
Output frequency	300 kHz
Number of channels	3
Current consumption	0...75 mA (no-load)
Protection type	Reverse polarity protection Short-circuit protection
Maximum output current	40 mA
Output level	Low level: 0.5 V maximum (20 mA) High level: 4.5 V minimum (20 mA)
Surge withstand	1 kV, level 2 conforming to IEC 61000-4-5
Base material	Aluminium
Shaft material	Stainless steel
Type of ball bearings	6000ZZ1
Product weight	1.03 lb(US) (0.465 kg)

Environment

marking	CE
ambient air temperature for operation	-22...212 °F (-30...100 °C)
ambient air temperature for storage	-22...185 °F (-30...85 °C)
IP degree of protection	IP65 conforming to IEC 60529
vibration resistance	10 gn (f = 55...2000 Hz) conforming to IEC 60068-2-6
shock resistance	30 gn 11 ms conforming to IEC 60068-2-27
resistance to electrostatic discharge	8 kV (air discharge) level 3 conforming to IEC 61000-4-2 4 kV (contact discharge) level 3 conforming to IEC 61000-4-2
resistance to electromagnetic fields	9.14 V/yd (10 V/m) level 3 conforming to IEC 61000-4-3
resistance to fast transients	1 kV (signal ports) level 3 conforming to IEC 61000-4-4 2 kV (power ports) level 3 conforming to IEC 61000-4-4

Offer Sustainability

Not Green Premium product	Not Green Premium product
Compliant - since 0701 - Schneider Electric declaration of conformity	Compliant - since 0701 - Schneider Electric declaration of conformity
Reference not containing SVHC above the threshold	Reference not containing SVHC above the threshold
WARNING: This product can expose you to chemicals including:	WARNING: This product can expose you to chemicals including:
Diisononyl phthalate (DINP), which is known to the State of California to cause cancer, and	Diisononyl phthalate (DINP), which is known to the State of California to cause cancer, and
Di-isodecyl phthalate (DIDP), which is known to the State of California to cause birth defects or other reproductive harm.	Di-isodecyl phthalate (DIDP), which is known to the State of California to cause birth defects or other reproductive harm.
For more information go to www.p65warnings.ca.gov	For more information go to www.p65warnings.ca.gov

Contractual warranty

Warranty period	18 months
-----------------	-----------

Dimensions

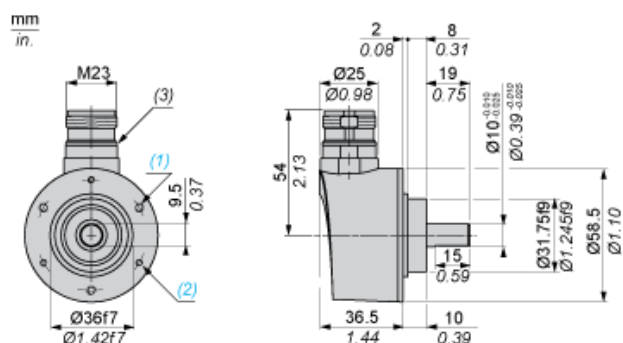

- (1) 3 M4 holes at 120° on 48 PCD, depth: 8 mm
- (2) 3 M3 holes at 120° on 48 PCD, depth: 8 mm
- (3) Nitrile seal

Wiring Diagram

Type X Output Stage

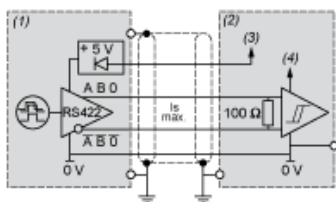

- (1) Encoder
- (2) Processing
- (3) Supply 4.75 V/30 V
- (4) Supply 5 V

Wiring Diagram

M23, 12-pin Connector Connections

Male Connector on Encoder



Pin number	1	2	3	4	5	6	7	8	9	10	11	12
Signal Supply	A ⁻	+V	0	0 ⁻	B	B ⁻	R	A	R	0 V	0 V	+V

R = reserved, do not connect

Данный компонент на территории Российской Федерации

Вы можете приобрести в компании MosChip.

Для оперативного оформления запроса Вам необходимо перейти по данной ссылке:

<http://moschip.ru/get-element>

Вы можете разместить у нас заказ для любого Вашего проекта, будь то серийное производство или разработка единичного прибора.

В нашем ассортименте представлены ведущие мировые производители активных и пассивных электронных компонентов.

Нашей специализацией является поставка электронной компонентной базы двойного назначения, продукции таких производителей как XILINX, Intel (ex.ALTERA), Vicor, Microchip, Texas Instruments, Analog Devices, Mini-Circuits, Amphenol, Glenair.

Сотрудничество с глобальными дистрибьюторами электронных компонентов, предоставляет возможность заказывать и получать с международных складов практически любой перечень компонентов в оптимальные для Вас сроки.

На всех этапах разработки и производства наши партнеры могут получить квалифицированную поддержку опытных инженеров.

Система менеджмента качества компании отвечает требованиям в соответствии с ГОСТ Р ИСО 9001, ГОСТ РВ 0015-002 и ЭС РД 009

Офис по работе с юридическими лицами:

105318, г.Москва, ул.Щербаковская д.3, офис 1107, 1118, ДЦ «Щербаковский»

Телефон: +7 495 668-12-70 (многоканальный)

Факс: +7 495 668-12-70 (доб.304)

E-mail: info@moschip.ru

Skype отдела продаж:

moschip.ru

moschip.ru_4

moschip.ru_6

moschip.ru_9