



# 0.1GHz to 3GHz, 75dB Logarithmic Detector/Controller

MAX2015

## General Description

The MAX2015 complete multistage logarithmic amplifier is designed to accurately convert radio-frequency (RF) signal power in the 0.1GHz to 3GHz frequency range to an equivalent DC voltage. The outstanding dynamic range and precision over temperature of this log amplifier make it particularly useful for a variety of base station and other wireless applications, including automatic gain control (AGC), transmitter power measurements, and received signal strength indication (RSSI) for terminal devices.

The MAX2015 can also be operated in a controller mode where it measures, compares, and controls the output power of a variable-gain amplifier as part of a fully integrated AGC loop.

This logarithmic amplifier provides much wider measurement range and superior accuracy compared to controllers based on diode detectors, while achieving excellent temperature stability over the full -40°C to +85°C operating range.

## Applications

- AGC Measurement and Control
- RF Transmitter Power Measurement
- RSSI Measurements
- Cellular Base Station, WLAN, Microwave Link, Radar, and other Military Applications

## Features

- ◆ Complete RF Detector/Controller
- ◆ 0.1GHz to 3GHz Frequency Range
- ◆ Exceptional Accuracy Over Temperature
- ◆ High Dynamic Range
- ◆ 2.7V to 5.25V Supply Voltage Range\*
- ◆ Scaling Stable Over Supply and Temperature Variations
- ◆ Controller Mode with Error Output
- ◆ Shutdown Mode with Typically 1µA of Supply Current
- ◆ Available in 8-Pin µMAX® and TDFN Packages

\*See Power-Supply Connections section.  
µMAX is a registered trademark of Maxim Integrated Products, Inc.

## Ordering Information

PART	TEMP RANGE	PIN-PACKAGE	PKG CODE
MAX2015EUA	-40°C to +85°C	8 µMAX	U8-1
MAX2015EUA-T	-40°C to +85°C	8 µMAX	U8-1

T = Tape-and-reel.  
+Denotes lead-free and RoHS compliance.  
\*EP = Exposed paddle.

Ordering Information continued at end of data sheet.

## Functional Diagram

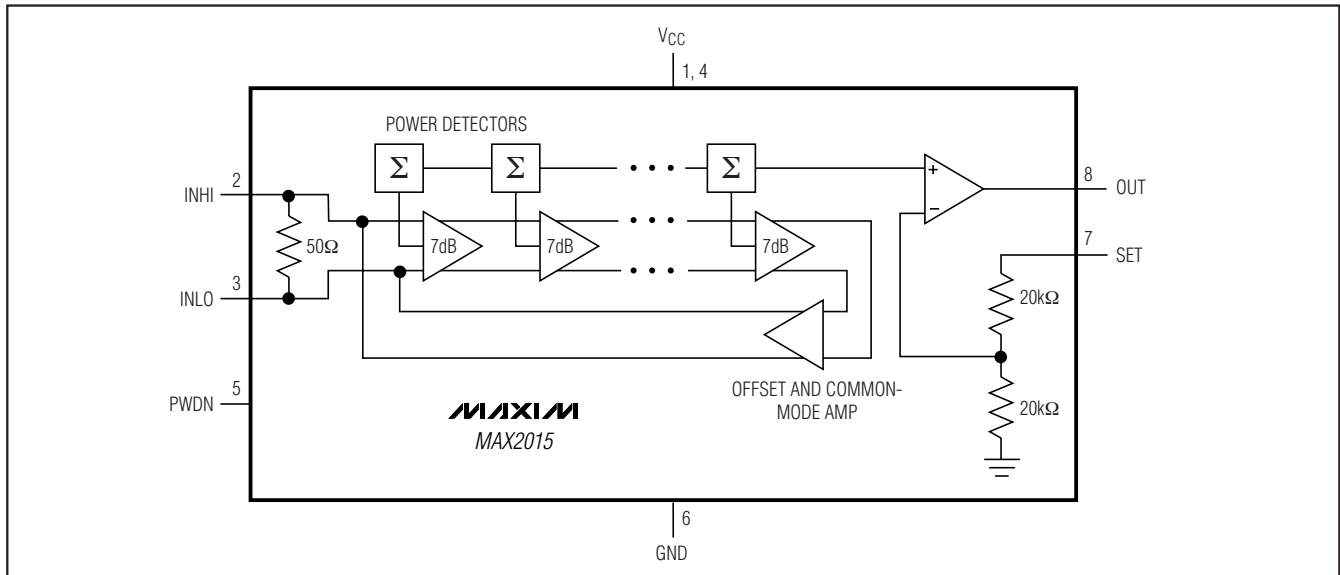

Pin Configuration appears at end of data sheet.



For pricing, delivery, and ordering information, please contact Maxim/Dallas Direct! at 1-888-629-4642, or visit Maxim's website at [www.maxim-ic.com](http://www.maxim-ic.com).

# 0.1GHz to 3GHz, 75dB Logarithmic Detector/Controller

## ABSOLUTE MAXIMUM RATINGS

V <sub>CC</sub> (Pins, 1, 4) to GND	-0.3V to +5.25V
SET, PWDN to GND	-0.3V to (V <sub>CC</sub> + 0.3V)
Input Power Differential INHI, INLO	+23dBm
Input Power Single Ended (INHI or INLO grounded)	+19dBm
Continuous Power Dissipation (T <sub>A</sub> = +70°C)	
8-Pin $\mu$ MAX (derate 4.5mW/°C above +70°C)	362mW
8-Pin TDFN (derate 18.5mW/°C above +70°C)	1480mW

Operating Temperature Range	-40°C to +85°C
Junction Temperature	+150°C
Storage Temperature Range	-65°C to +150°C
Lead Temperature (soldering, 10s)	+300°C

Stresses beyond those listed under "Absolute Maximum Ratings" may cause permanent damage to the device. These are stress ratings only, and functional operation of the device at these or any other conditions beyond those indicated in the operational sections of the specifications is not implied. Exposure to absolute maximum rating conditions for extended periods may affect device reliability.

## DC ELECTRICAL CHARACTERISTICS

(MAX2015 typical application circuit (Figure 1), V<sub>S</sub> = +3.3V, f<sub>RF</sub> = 100MHz to 3000MHz, R<sub>1</sub> = 0 $\Omega$ , R<sub>4</sub> = 0 $\Omega$ , R<sub>L</sub> = 10k $\Omega$ , T<sub>A</sub> = -40°C to +85°C, unless otherwise noted. Typical values are at T<sub>A</sub> = +25°C, unless otherwise noted.) (Note 1)

PARAMETER	SYMBOL	CONDITIONS	MIN	TYP	MAX	UNITS
<b>POWER SUPPLY</b>						
Supply Voltage	V <sub>S</sub>	R <sub>4</sub> = 75 $\Omega$ $\pm$ 1%, PWDN must be connected to GND	4.75		5.25	V
		R <sub>4</sub> = 0 $\Omega$	2.7		3.6	
Supply Current	I <sub>CC</sub>	T <sub>A</sub> = +25°C, V <sub>S</sub> = 5.25V, R <sub>4</sub> = 75 $\Omega$		17.3		mA
		T <sub>A</sub> = +25°C		17.3	20.5	
Supply Current Variation with Temp	I <sub>CC</sub>	T <sub>A</sub> = -40°C to +85°C		0.05		mA/°C
Shutdown Current	I <sub>CC</sub>	V <sub>PWDN</sub> = V <sub>CC</sub>		1		$\mu$ A
<b>CONTROLLER REFERENCE (SET)</b>						
SET Input Voltage Range				0.5 to 1.8		V
SET Input Impedance				40		k $\Omega$
<b>DETECTOR OUTPUT (OUT)</b>						
Source Current				4		mA
Sink Current				450		$\mu$ A
Minimum Output Voltage	V <sub>OUT(MIN)</sub>			0.5		V
Maximum Output Voltage	V <sub>OUT(MAX)</sub>			1.8		V

# 0.1GHz to 3GHz, 75dB Logarithmic Detector/Controller

MAX2015

## AC ELECTRICAL CHARACTERISTICS

(MAX2015 typical application circuit (Figure 1),  $V_S = +3.3V$ ,  $f_{RF} = 100MHz$  to  $3000MHz$ ,  $R_1 = 0\Omega$ ,  $R_4 = 0\Omega$ ,  $R_L = 10k\Omega$ ,  $T_A = -40^\circ C$  to  $+85^\circ C$ , unless otherwise noted. Typical values are at  $T_A = +25^\circ C$ , unless otherwise noted.) (Note 1)

PARAMETER	SYMBOL	CONDITIONS	MIN	TYP	MAX	UNITS
RF Input Frequency Range	$f_{RF}$			0.1 to 3		GHz
Return Loss	$S_{11}$			-15		dB
Large-Signal Response Time		$P_{IN} = \text{no signal to } 0dBm, \pm 0.5dB \text{ settling accuracy}$		150		ns
<b>RSSI MODE—0.1GHz</b>						
RF Input Power Range		(Note 2)		-65 to +5		dBm
$\pm 3dB$ Dynamic Range		$T_A = -40^\circ C$ to $+85^\circ C$ (Note 3)		70		dB
Range Center				-30		dBm
Temp Sensitivity when $T_A > +25^\circ C$		$T_A = +25^\circ C$ to $+85^\circ C$ , $P_{IN} = -25dBm$		+0.0083		dB/ $^\circ C$
Temp Sensitivity when $T_A < +25^\circ C$		$T_A = -40^\circ C$ to $+25^\circ C$ , $P_{IN} = -25dBm$		-0.0154		dB/ $^\circ C$
Slope		(Note 4)		19		mV/dB
Typical Slope Variation		$T_A = -40^\circ C$ to $+85^\circ C$		-4		$\mu V/^\circ C$
Intercept		(Note 5)		-100		dBm
Typical Intercept Variation		$T_A = -40^\circ C$ to $+85^\circ C$		0.03		dBm/ $^\circ C$
<b>RSSI MODE—0.9GHz</b>						
RF Input Power Range		(Note 2)		-65 to +5		dBm
$\pm 3dB$ Dynamic Range		$T_A = -40^\circ C$ to $+85^\circ C$ (Note 3)		70		dB
Range Center				-30		dBm
Temp Sensitivity when $T_A > +25^\circ C$		$T_A = +25^\circ C$ to $+85^\circ C$ , $P_{IN} = -25dBm$		$\pm 0.0083$		dB/ $^\circ C$
Temp Sensitivity when $T_A < +25^\circ C$		$T_A = -40^\circ C$ to $+25^\circ C$ , $P_{IN} = -25dBm$		-0.0154		dB/ $^\circ C$
Slope		(Note 4)		18.1		mV/dB
Typical Slope Variation		$T_A = -40^\circ C$ to $+85^\circ C$		-4		$\mu V/^\circ C$
Intercept		(Note 5)		-97		dBm
Typical Intercept Variation		$T_A = -40^\circ C$ to $+85^\circ C$		0.02		dBm/ $^\circ C$
<b>RSSI MODE—1.9GHz</b>						
RF Input Power Range		(Note 2)		-55 to +5		dBm
$\pm 3dB$ Dynamic Range		$T_A = -40^\circ C$ to $+85^\circ C$ (Note 3)		60		dB
Range Center				-25		dBm
Temp Sensitivity when $T_A > +25^\circ C$		$T_A = +25^\circ C$ to $+85^\circ C$ , $P_{IN} = -25dBm$		$\pm 0.0033$		dB/ $^\circ C$
Temp Sensitivity when $T_A < +25^\circ C$		$T_A = -40^\circ C$ to $+25^\circ C$ , $P_{IN} = -25dBm$		-0.0138		dB/ $^\circ C$
Slope		(Note 4)		18		mV/dB
Typical Slope Variation		$T_A = -40^\circ C$ to $+85^\circ C$		-4.8		$\mu V/^\circ C$

# 0.1GHz to 3GHz, 75dB Logarithmic Detector/Controller

## AC ELECTRICAL CHARACTERISTICS (continued)

(MAX2015 typical application circuit (Figure 1),  $V_S = +3.3V$ ,  $f_{RF} = 100MHz$  to  $3000MHz$ ,  $R_1 = 0\Omega$ ,  $R_4 = 0\Omega$ ,  $R_L = 10k\Omega$ ,  $T_A = -40^\circ C$  to  $+85^\circ C$ , unless otherwise noted. Typical values are at  $T_A = +25^\circ C$ , unless otherwise noted.) (Note 1)

PARAMETER	SYMBOL	CONDITIONS	MIN	TYP	MAX	UNITS
Intercept		(Note 5)		-83		dBm
Typical Intercept Variation		$T_A = -40^\circ C$ to $+85^\circ C$		0.03		dBm/ $^\circ C$
<b>RSSI MODE—2.5GHz</b>						
RF Input Power Range		(Note 2)		-45 to -5		dBm
$\pm 3dB$ Dynamic Range		$T_A = -40^\circ C$ to $+85^\circ C$ (Note 3)		40		dB
Range Center				-25		dBm
Temp Sensitivity when $T_A > +25^\circ C$		$T_A = +25^\circ C$ to $+85^\circ C$ , $P_{IN} = -25dBm$		-0.0083		dB/ $^\circ C$
Temp Sensitivity when $T_A < +25^\circ C$		$T_A = -40^\circ C$ to $+25^\circ C$ , $P_{IN} = -25dBm$		-0.0083		dB/ $^\circ C$
Slope		(Note 4)		16.8		mV/dB
Typical Slope Variation		$T_A = -40^\circ C$ to $+85^\circ C$		-8		$\mu V/^\circ C$
Intercept		(Note 5)		-81		dBm
Typical Intercept Variation		$T_A = -40^\circ C$ to $+85^\circ C$		0.03		dBm/ $^\circ C$

**Note 1:** The MAX2015 is guaranteed by design for  $T_A = -40^\circ C$  to  $+85^\circ C$ , as specified.

**Note 2:** Typical minimum and maximum range of the detector at the stated frequency.

**Note 3:** Dynamic range refers to the range over which the error remains within the stated bounds. The error is calculated at  $-40^\circ C$  and  $+85^\circ C$ , relative to the curve at  $+25^\circ C$ .

**Note 4:** The slope is the variation of the output voltage per change in input power. It is calculated by fitting a root-mean-square (RMS) straight line to the data indicated by RF input power range.

**Note 5:** The intercept is an extrapolated value that corresponds to the output power for which the output voltage is zero. It is calculated by fitting an RMS straight line to the data.

# 0.1GHz to 3GHz, 75dB Logarithmic Detector/Controller

## Typical Operating Characteristics

(MAX2015 typical application circuit (Figure 1),  $V_S = V_{CC} = 3.3V$ ,  $P_{IN} = -10dBm$ ,  $f_{IN} = 100MHz$ ,  $R_1 = 0\Omega$ ,  $R_4 = 0\Omega$ ,  $R_L = 10k\Omega$ ,  $V_{PWND} = 0V$ ,  $T_A = +25^\circ C$ , unless otherwise noted.)

MAX2015

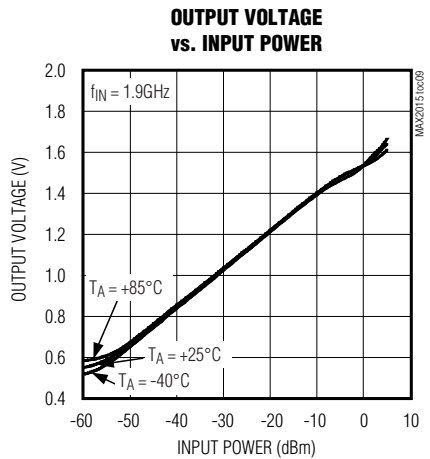
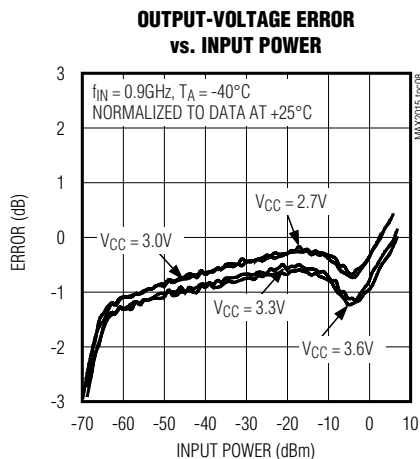
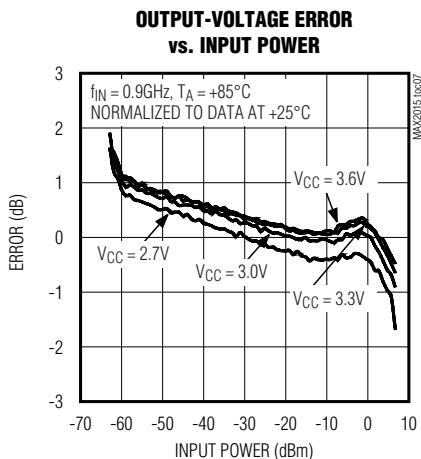
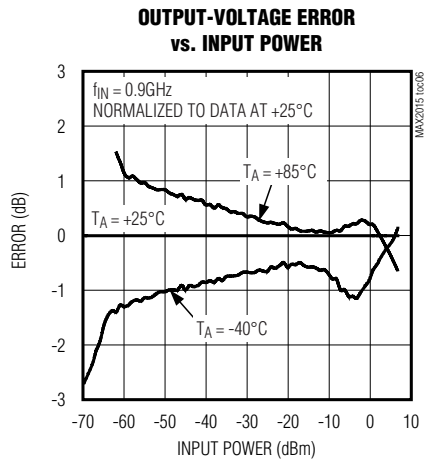
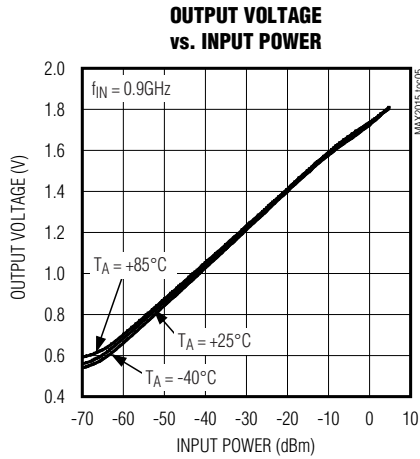
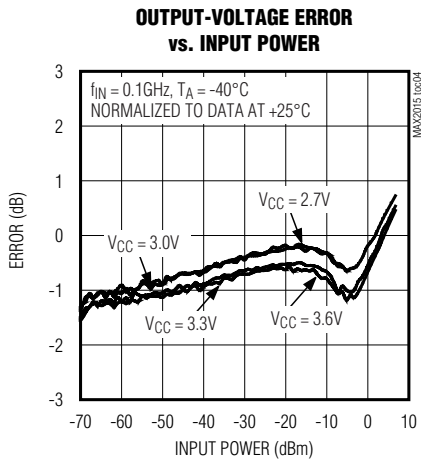
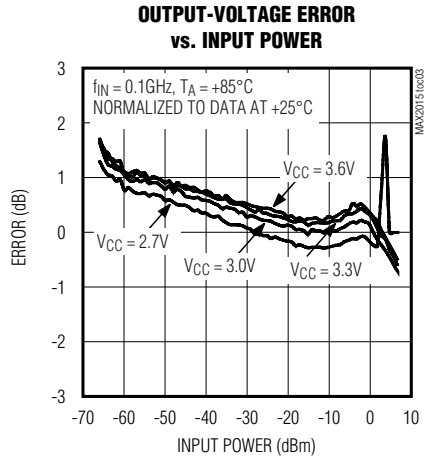
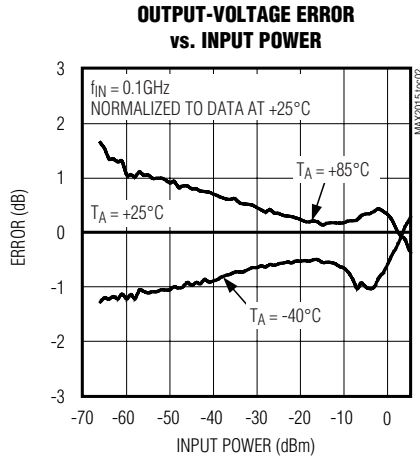
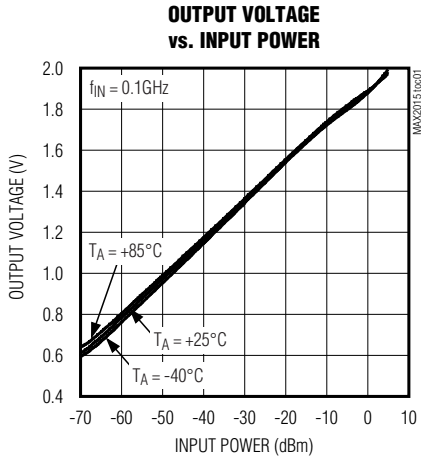

# 0.1GHz to 3GHz, 75dB Logarithmic Detector/Controller

## Typical Operating Characteristics (continued)

(MAX2015 typical application circuit (Figure 1),  $V_S = V_{CC} = 3.3V$ ,  $P_{IN} = -10dBm$ ,  $f_{IN} = 100MHz$ ,  $R_1 = 0\Omega$ ,  $R_4 = 0\Omega$ ,  $R_L = 10k\Omega$ ,  $V_{PWDN} = 0V$ ,  $T_A = +25^\circ C$ , unless otherwise noted.)

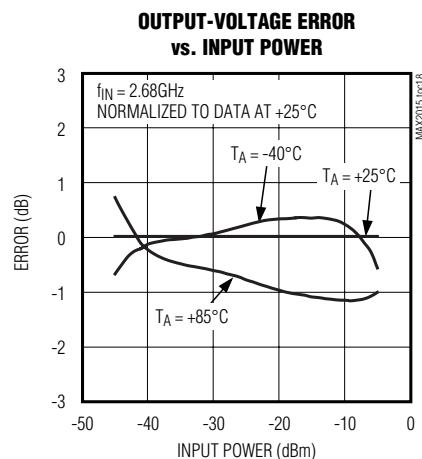
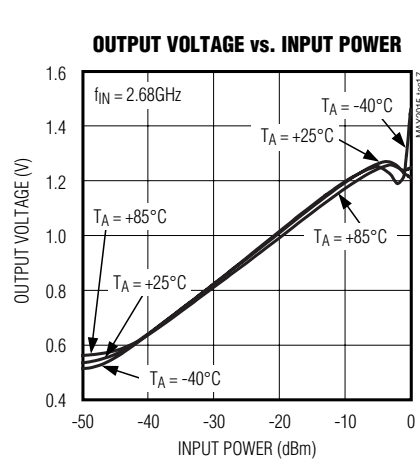
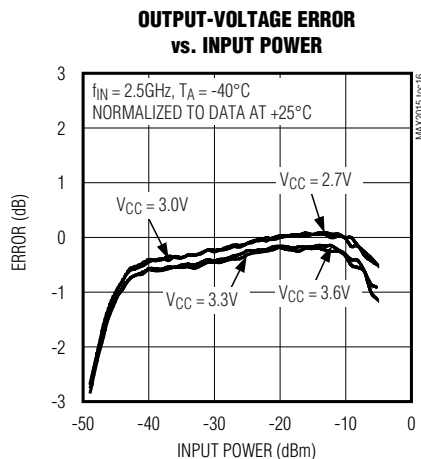
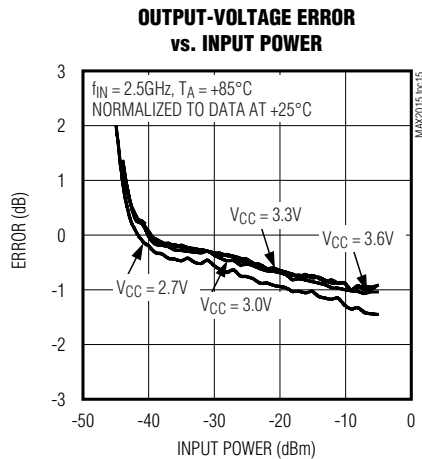
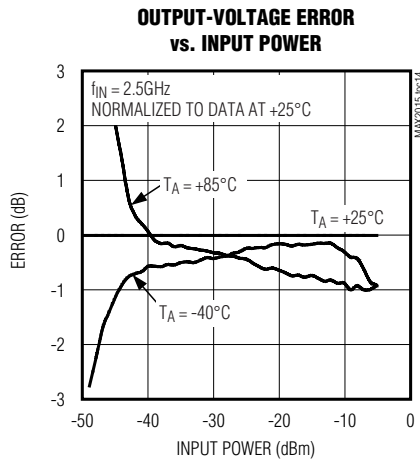
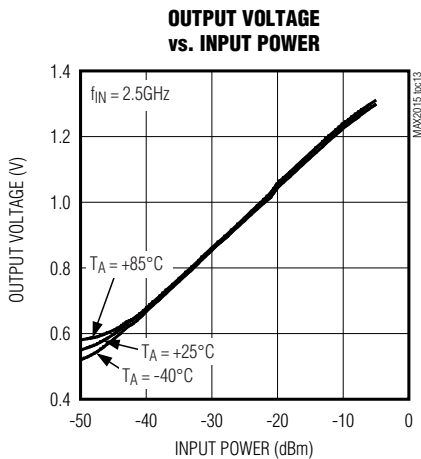
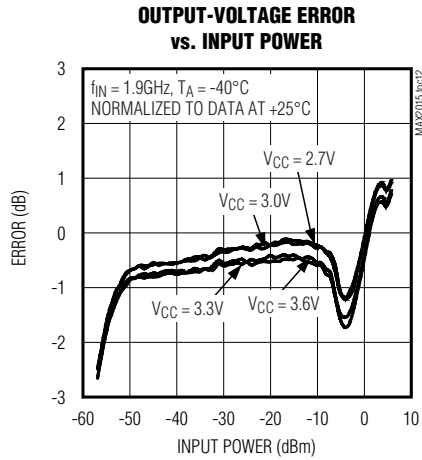
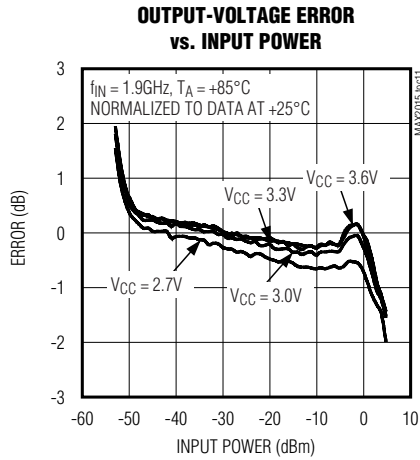
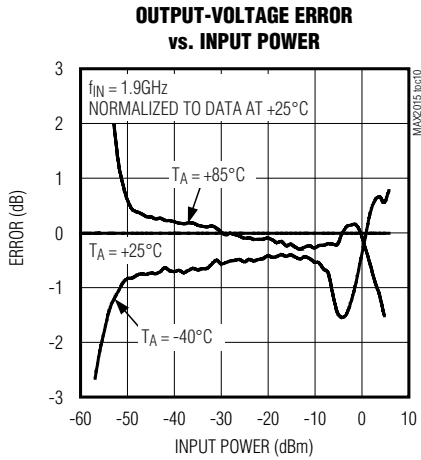

# 0.1GHz to 3GHz, 75dB Logarithmic Detector/Controller

MAX2015

## Typical Operating Characteristics (continued)

(MAX2015 typical application circuit (Figure 1),  $V_S = V_{CC} = 3.3V$ ,  $P_{IN} = -10dBm$ ,  $f_{IN} = 100MHz$ ,  $R_1 = 0\Omega$ ,  $R_4 = 0\Omega$ ,  $R_L = 10k\Omega$ ,  $V_{PWDN} = 0V$ ,  $T_A = +25^\circ C$ , unless otherwise noted.)

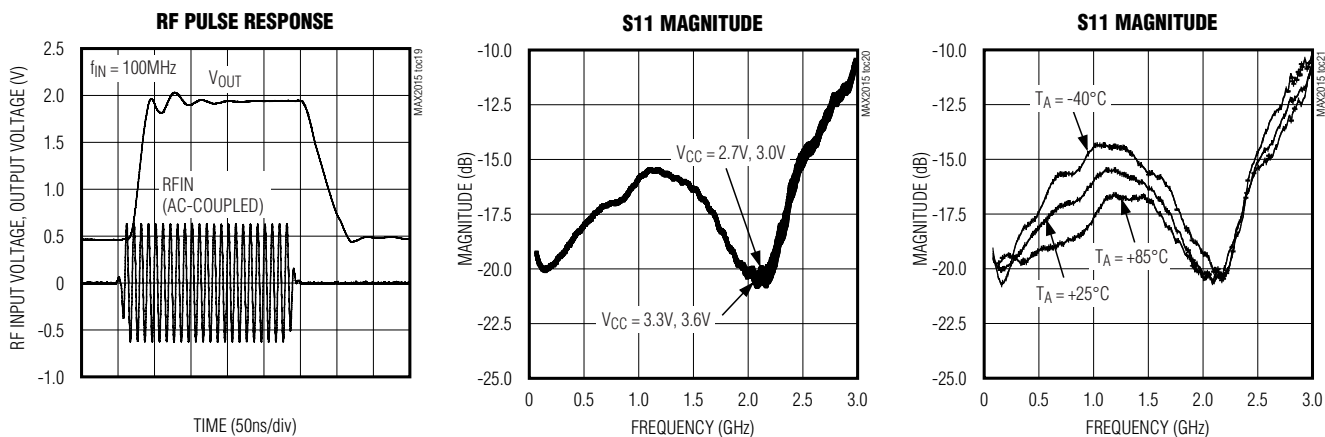

## Pin Description

PIN	NAME	FUNCTION
1, 4	VCC	Supply Voltage. Bypass with capacitors as specified in the application drawing. Place capacitors as close to the pin as possible (see the <i>Power-Supply Connections</i> section).
2, 3	INHI, INLO	Differential RF Inputs
5	PWDN	Power-Down Input. Drive PWDN with a logic-high to power down the IC. PWDN must be connected to GND for $V_S$ between 4.75V and 5.25V with $R_4 = 75\Omega$ .
6	GND	Ground. Connect to the PCB ground plane.
7	SET	Set-Point Input. To operate in detector mode, connect SET to OUT. To operate in controller mode, connect a precision voltage source to control the power level of a power amplifier.
8	OUT	Detector Output. In detector mode, this output provides a voltage proportional to the log of the input power. In controller mode, this output is connected to a power-control input on a power amplifier (PA).
—	EP	Exposed Paddle (TDFN package only). Connect EP to GND using multiple vias, or the EP can also be left unconnected.

# 0.1GHz to 3GHz, 75dB Logarithmic Detector/Controller

## Detailed Description

The MAX2015 is a successive detection logarithmic amplifier designed for use in RF power measurement and AGC applications with a 0.1GHz to 3GHz frequency range from a single 2.7V to 3.6V power supply. It is pin compatible with other leading logarithmic amplifiers.

The MAX2015 provides for improved performance with a high 75dB dynamic range at 100MHz, and exceptional accuracy over the extended temperature range and supply voltage range.

### RF Input

The MAX2015 differential RF input (INHI, INLO) allows for broadband signals between 100MHz and 3GHz. For single-ended signals, AC-couple INLO to ground. The RF inputs are internally biased and need to be AC-coupled using 680pF capacitors as shown in Figure 1 and Figure 2. An internal 50Ω resistor between INHI and INLO provides a good 50MHz to 3.0GHz match.

### SET Input

The SET input is used for loop control when in controller mode or to set the slope of the output signal (mV/dB) when in detector mode. The internal input structure of SET is two series 20kΩ resistors connected to ground. The center node of the resistors is fed to the negative input of the internal output op amp.

### Power-Supply Connections

The MAX2015 requires power-supply bypass capacitors connected close to each VCC pin. At each VCC pin, connect a 0.1μF capacitor (C4, C6) and a 100pF capacitor (C3, C5) with the 100pF capacitor being closest to the pin.

For power-supply voltages (V<sub>S</sub>) between 2.7V and 3.6V, set R4 = 0Ω (see the typical applications circuits).

For power-supply voltages (V<sub>S</sub>) between 4.75V and 5.25V, set R4 = 75Ω ±1% (100ppm/°C max) and PWDN must be connected to GND.

### Power-Down Mode

The MAX2015 can be powered down by driving PWDN with logic high (logic high = V<sub>CC</sub>). In power-down mode, the supply current is reduced to a typical value of 1μA. For normal operation, drive PWDN with a logic low. It is recommended when using power-down that an RF signal not be applied before the power-down signal is low.

## Applications Information

### Detector (RSSI) Mode

In detector mode, the MAX2015 acts like an RSSI, which provides an output voltage proportional to the input power. This is accomplished by providing a feedback path from OUT to SET (R1 = 0Ω; see Figure 1).

By connecting SET directly to OUT, the op amp gain is set to 2V/V due to two internal 20kΩ feedback resistors. This provides a detector slope of approximately 18mV/dB with a 0.5V to 1.8V output range.

### Controller Mode

The MAX2015 can also be used as a detector/controller within an AGC loop. Figure 3 depicts one scenario where the MAX2015 is employed as the controller for a variable-gain PA. As shown in the figure, the MAX2015 monitors the output of the PA through a directional coupler. An internal integrator (Figure 2) compares the

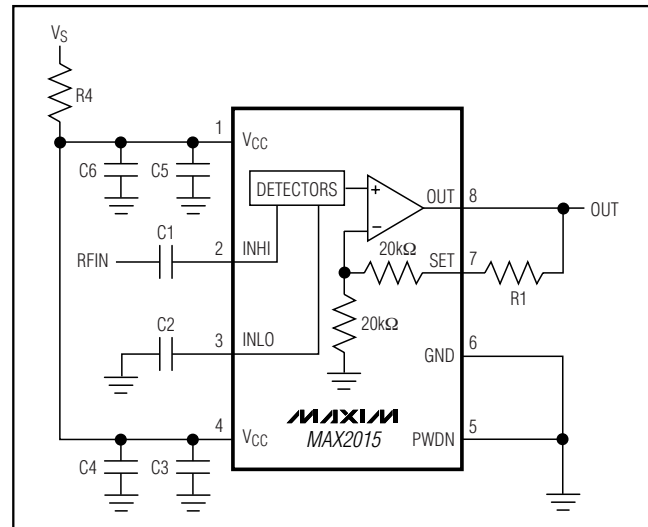

Figure 1. Detector-Mode (RSSI) Typical Application Circuit

Table 1. Suggested Components of Typical Applications Circuits

DESIGNATION	VALUE	TYPE
C1, C2	680pF	0603 ceramic capacitors
C3, C5	100pF	0603 ceramic capacitors
C4, C6	0.1μF	0603 ceramic capacitors
R1*	0Ω	0603 resistor
R4**	0Ω	0603 resistor

\*RSSI mode only.

\*\*V<sub>S</sub> = 2.7V to 3.6V.



# 0.1GHz to 3GHz, 75dB Logarithmic Detector/Controller

MAX2015

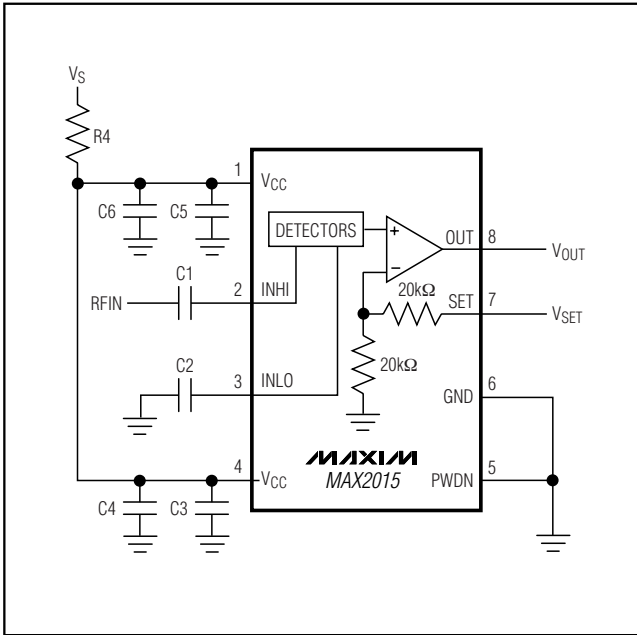

Figure 2. Controller-Mode Typical Application Circuit

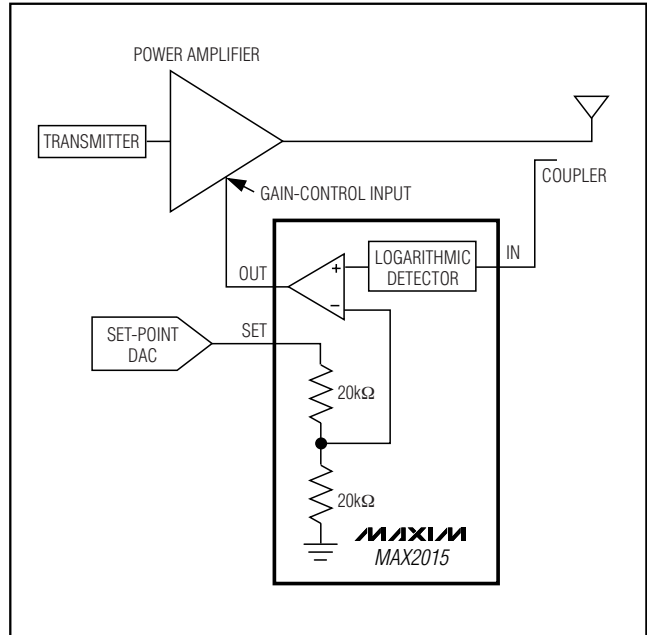

Figure 3. System Diagram for Automatic Gain-Control Loop

detected signal with a reference voltage determined by  $V_{SET}$ . The integrator, acting like a comparator, increases or decreases the voltage at OUT, according to how closely the detected signal level matches the  $V_{SET}$  reference. The MAX2015 adjusts the power of the PA to a level determined by the voltage applied to SET. With  $R_1 = 0\Omega$ , the controller mode slope is approximately 19mV/dB (RF = 100MHz).

### Layout Considerations

As with any RF circuit, the layout of the MAX2015 circuit affects the device's performance. Use an abundant number of ground vias to minimize RF coupling. Place the input capacitors (C1, C2) and the bypass capacitors (C3–C6) as close to the IC as possible. Connect the bypass capacitors to the ground plane with multiple vias.

# 0.1GHz to 3GHz, 75dB Logarithmic Detector/Controller

## Ordering Information (continued)

PART	TEMP RANGE	PIN-PACKAGE	PKG CODE
MAX2015EUA+	-40°C to +85°C	8 $\mu$ MAX	U8-1
MAX2015EUA+T	-40°C to +85°C	8 $\mu$ MAX	U8-1
MAX2015ETA	-40°C to +85°C	8 TDFN-EP* (3mm x 3mm)	T833-2
MAX2015ETA-T	-40°C to +85°C	8 TDFN-EP* (3mm x 3mm)	T833-2
MAX2015ETA+	-40°C to +85°C	8 TDFN-EP* (3mm x 3mm)	T833-2
MAX2015ETA+T	-40°C to +85°C	8 TDFN-EP* (3mm x 3mm)	T833-2

T = Tape-and-reel.

+Denotes lead-free and RoHS compliance.

\*EP = Exposed paddle.

## Pin Configuration

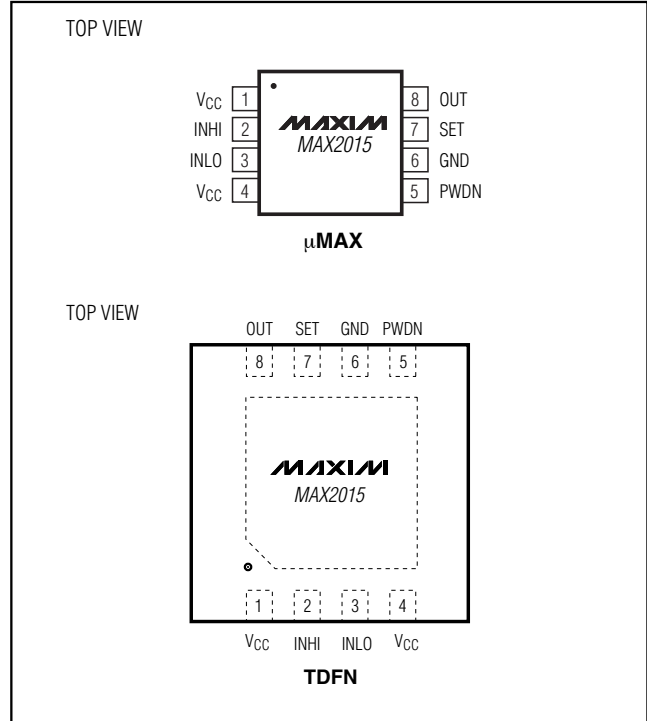

## Chip Information

TRANSISTOR COUNT: 3157

PROCESS: BICMOS

# 0.1GHz to 3GHz, 75dB Logarithmic Detector/Controller

## Package Information

(The package drawing(s) in this data sheet may not reflect the most current specifications. For the latest package outline information, go to [www.maxim-ic.com/packages](http://www.maxim-ic.com/packages).)

MAX2015

8LUMAXD.EPS

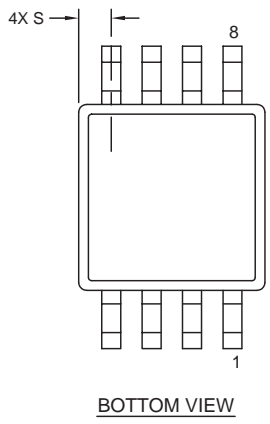
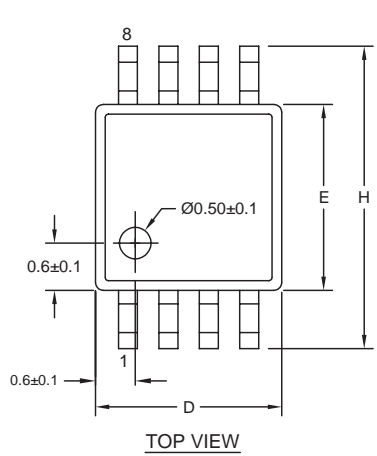

DIM	INCHES		MILLIMETERS	
	MIN	MAX	MIN	MAX
A	-	0.043	-	1.10
A1	0.002	0.006	0.05	0.15
A2	0.030	0.037	0.75	0.95
b	0.010	0.014	0.25	0.36
c	0.005	0.007	0.13	0.18
D	0.116	0.120	2.95	3.05
e	0.0256 BSC		0.65 BSC	
E	0.116	0.120	2.95	3.05
H	0.188	0.198	4.78	5.03
L	0.016	0.026	0.41	0.66
$\alpha$	0°	6°	0°	6°
S	0.0207 BSC		0.5250 BSC	

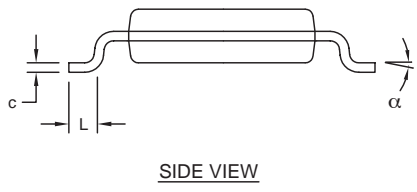
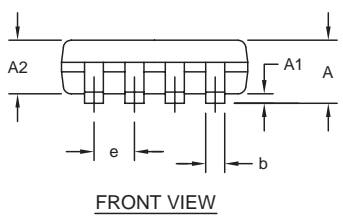

- NOTES:
1. D&E DO NOT INCLUDE MOLD FLASH.
  2. MOLD FLASH OR PROTRUSIONS NOT TO EXCEED 0.15MM (.006").
  3. CONTROLLING DIMENSION: MILLIMETERS.
  4. MEETS JEDEC MO-187C-AA.

**DALLAS SEMICONDUCTOR** **MAXIM**

PROPRIETARY INFORMATION

TITLE: PACKAGE OUTLINE, 8L uMAX/uSOP

APPROVAL	DOCUMENT CONTROL NO. 21-0036	REV. J	1/1
----------	---------------------------------	-----------	-----



# 0.1GHz to 3GHz, 75dB Logarithmic Detector/Controller

MAX2015

## Package Information (continued)

(The package drawing(s) in this data sheet may not reflect the most current specifications. For the latest package outline information, go to [www.maxim-ic.com/packages](http://www.maxim-ic.com/packages).)

COMMON DIMENSIONS			PACKAGE VARIATIONS							
SYMBOL	MIN.	MAX.	PKG. CODE	N	D2	E2	e	JEDEC SPEC	b	[(N/2)-1] x e
A	0.70	0.80	T633-1	6	1.50±0.10	2.30±0.10	0.95 BSC	MO229 / WEEA	0.40±0.05	1.90 REF
D	2.90	3.10	T633-2	6	1.50±0.10	2.30±0.10	0.95 BSC	MO229 / WEEA	0.40±0.05	1.90 REF
E	2.90	3.10	T833-1	8	1.50±0.10	2.30±0.10	0.65 BSC	MO229 / WEEC	0.30±0.05	1.95 REF
A1	0.00	0.05	T833-2	8	1.50±0.10	2.30±0.10	0.65 BSC	MO229 / WEEC	0.30±0.05	1.95 REF
L	0.20	0.40	T833-3	8	1.50±0.10	2.30±0.10	0.65 BSC	MO229 / WEEC	0.30±0.05	1.95 REF
k	0.25 MIN.		T1033-1	10	1.50±0.10	2.30±0.10	0.50 BSC	MO229 / WEED-3	0.25±0.05	2.00 REF
A2	0.20 REF.		T1033-2	10	1.50±0.10	2.30±0.10	0.50 BSC	MO229 / WEED-3	0.25±0.05	2.00 REF
			T1433-1	14	1.70±0.10	2.30±0.10	0.40 BSC	----	0.20±0.05	2.40 REF
			T1433-2	14	1.70±0.10	2.30±0.10	0.40 BSC	----	0.20±0.05	2.40 REF

NOTES:

1. ALL DIMENSIONS ARE IN mm. ANGLES IN DEGREES.
2. COPLANARITY SHALL NOT EXCEED 0.08 mm.
3. WARPAGE SHALL NOT EXCEED 0.10 mm.
4. PACKAGE LENGTH/PACKAGE WIDTH ARE CONSIDERED AS SPECIAL CHARACTERISTIC(S).
5. DRAWING CONFORMS TO JEDEC MO229, EXCEPT DIMENSIONS "D2" AND "E2", AND T1433-1 & T1433-2.
6. "N" IS THE TOTAL NUMBER OF LEADS.
7. NUMBER OF LEADS SHOWN ARE FOR REFERENCE ONLY.

⚠ MARKING IS FOR PACKAGE ORIENTATION REFERENCE ONLY.

-DRAWING NOT TO SCALE-



TITLE: PACKAGE OUTLINE, 6,8,10 & 14L,  
TDFN, EXPOSED PAD, 3x3x0.80 mm

APPROVAL	DOCUMENT CONTROL NO. 21-0137	REV. H	2/2
----------	---------------------------------	-----------	-----

## Revision History

Pages changed at Rev 2: 1–10, 12, 13

Maxim cannot assume responsibility for use of any circuitry other than circuitry entirely embodied in a Maxim product. No circuit patent licenses are implied. Maxim reserves the right to change the circuitry and specifications without notice at any time.

**Maxim Integrated Products, 120 San Gabriel Drive, Sunnyvale, CA 94086 408-737-7600** \_\_\_\_\_ 13

## Данный компонент на территории Российской Федерации

### Вы можете приобрести в компании MosChip.

Для оперативного оформления запроса Вам необходимо перейти по данной ссылке:

<http://moschip.ru/get-element>

Вы можете разместить у нас заказ для любого Вашего проекта, будь то серийное производство или разработка единичного прибора.

В нашем ассортименте представлены ведущие мировые производители активных и пассивных электронных компонентов.

Нашей специализацией является поставка электронной компонентной базы двойного назначения, продукции таких производителей как XILINX, Intel (ex.ALTERA), Vicor, Microchip, Texas Instruments, Analog Devices, Mini-Circuits, Amphenol, Glenair.

Сотрудничество с глобальными дистрибьюторами электронных компонентов, предоставляет возможность заказывать и получать с международных складов практически любой перечень компонентов в оптимальные для Вас сроки.

На всех этапах разработки и производства наши партнеры могут получить квалифицированную поддержку опытных инженеров.

Система менеджмента качества компании отвечает требованиям в соответствии с ГОСТ Р ИСО 9001, ГОСТ РВ 0015-002 и ЭС РД 009

### Офис по работе с юридическими лицами:

105318, г.Москва, ул.Щербаковская д.3, офис 1107, 1118, ДЦ «Щербаковский»

Телефон: +7 495 668-12-70 (многоканальный)

Факс: +7 495 668-12-70 (доб.304)

E-mail: [info@moschip.ru](mailto:info@moschip.ru)

Skype отдела продаж:

moschip.ru

moschip.ru\_4

moschip.ru\_6

moschip.ru\_9