

## MMIC VCO WITH HALF FREQUENCY OUTPUT 9.6 - 10.8 GHz



### Typical Applications

Low noise MMIC VCO w/Half Frequency, Divide-by-4 Outputs for:

- Point to Point/Multipoint Radio
- Test Equipment & Industrial Controls
- SATCOM
- Military End-Use

### Features

Triple Output:  $F_o = 9.6 - 10.8$  GHz  
 $F_o/2 = 4.8 - 5.4$  GHz  
 $F_o/4 = 2.4 - 2.7$  GHz

Pout: +9 dBm

Phase Noise: -110 dBc/Hz @100 kHz Typ.

No External Resonator Needed

32 Lead 5 x 5 mm SMT Package: 25 mm<sup>2</sup>

### Functional Diagram

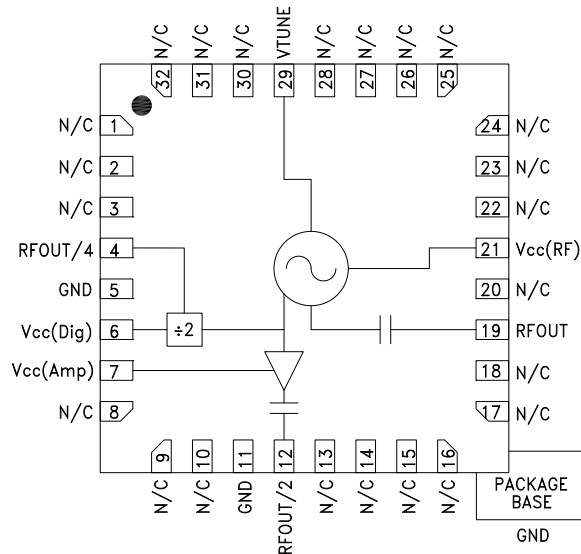

### General Description

The HMC512LP5 & HMC512LP5E are GaAs InGaP Heterojunction Bipolar Transistor (HBT) MMIC VCOs. The HMC512LP5 & HMC512LP5E integrate resonators, negative resistance devices, varactor diodes and feature half frequency and divide-by-4 outputs. The VCO's phase noise performance is excellent over temperature, shock, and process due to the oscillator's monolithic structure. Power output is +9 dBm typical from a +5V supply voltage. The prescaler and RF/2 functions can be disabled to conserve current if not required. The voltage controlled oscillator is packaged in a leadless QFN 5x5 mm surface mount package, and requires no external matching components.

### Electrical Specifications, $T_A = +25^\circ\text{C}$ , $V_{cc}(\text{Dig})$ , $V_{cc}(\text{Amp})$ , $V_{cc}(\text{RF}) = +5\text{V}$

Parameter	Min.	Typ.	Max.	Units	
Frequency Range	$F_o$ $F_o/2$	9.6 - 10.8 4.8 - 5.4		GHz GHz	
Power Output	RFOUT RFOUT/2 RFOUT/4	+3 +6 -8	+15 +14 -3	dBm dBm dBm	
SSB Phase Noise @ 100 kHz Offset, Vtune= +5V @ RFOUT		-110		dBc/Hz	
Tune Voltage	Vtune	2	13	V	
Supply Current	$I_{cc}(\text{Dig}) + I_{cc}(\text{Amp}) + I_{cc}(\text{RF})$	250	330	370	mA
Tune Port Leakage Current (Vtune= 12V)			10	$\mu\text{A}$	
Output Return Loss		3		dB	
Harmonics/Subharmonics	1/2 2nd 3rd		33 25 35	dBc dBc dBc	
Pulling (into a 2.0:1 VSWR)		5		MHz pp	
Pushing @ Vtune= 5V		30		MHz/V	
Frequency Drift Rate		1.2		MHz/ $^\circ\text{C}$	

Information furnished by Analog Devices is believed to be accurate and reliable. However, no responsibility is assumed by Analog Devices for its use, nor for any infringements of patents or other rights of third parties that may result from its use. Specifications subject to change without notice. No license is granted by implication or otherwise under any patent or patent rights of Analog Devices. Trademarks and registered trademarks are the property of their respective owners.

For price, delivery, and to place orders: Analog Devices, Inc., One Technology Way, P.O. Box 9106, Norwood, MA 02062-9106  
 Phone: 781-329-4700 • Order online at [www.analog.com](http://www.analog.com)  
 Application Support: Phone: 1-800-ANALOG-D



**MMIC VCO WITH HALF FREQUENCY OUTPUT  
9.6 - 10.8 GHz**

**Frequency vs. Tuning Voltage**

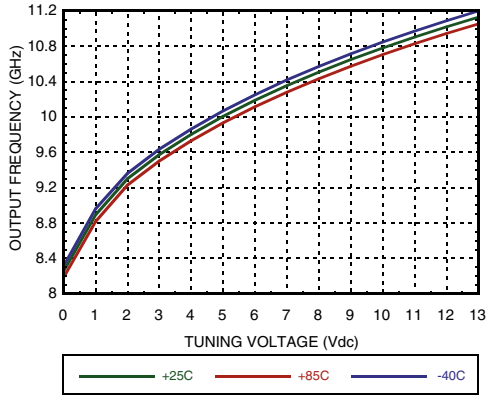

**Frequency vs. Tuning Voltage, T = 25°C**

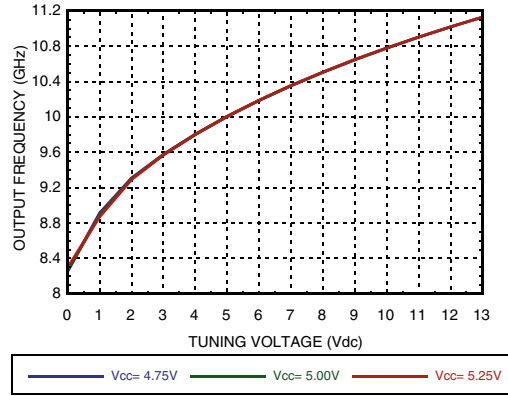

**Sensitivity vs. Tuning Voltage**

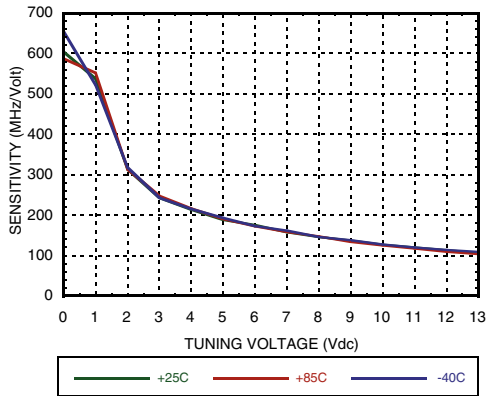

**Output Power vs. Tuning Voltage**

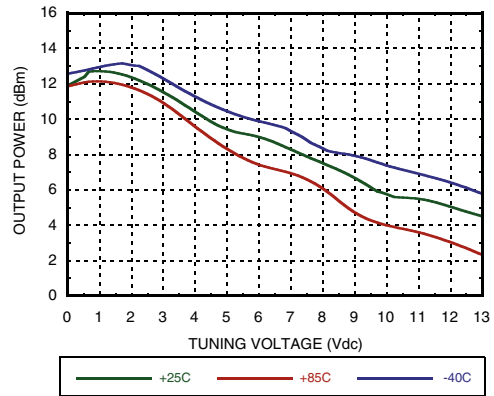

**SSB Phase Noise vs. Tuning Voltage**

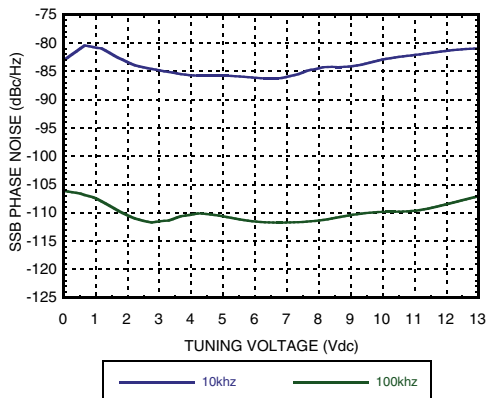

**SSB Phase Noise @ Vtune = +5V**

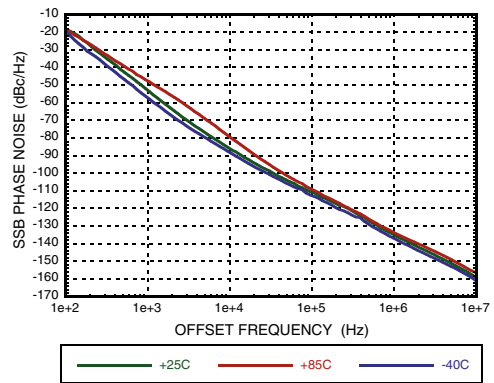

Information furnished by Analog Devices is believed to be accurate and reliable. However, no responsibility is assumed by Analog Devices for its use, nor for any infringements of patents or other rights of third parties that may result from its use. Specifications subject to change without notice. No license is granted by implication or otherwise under any patent or patent rights of Analog Devices. Trademarks and registered trademarks are the property of their respective owners.

For price, delivery, and to place orders: Analog Devices, Inc., One Technology Way, P.O. Box 9106, Norwood, MA 02062-9106 Phone: 781-329-4700 • Order online at [www.analog.com](http://www.analog.com) Application Support: Phone: 1-800-ANALOG-D

## MMIC VCO WITH HALF FREQUENCY OUTPUT 9.6 - 10.8 GHz



### RFOUT/2 Frequency vs. Tuning Voltage

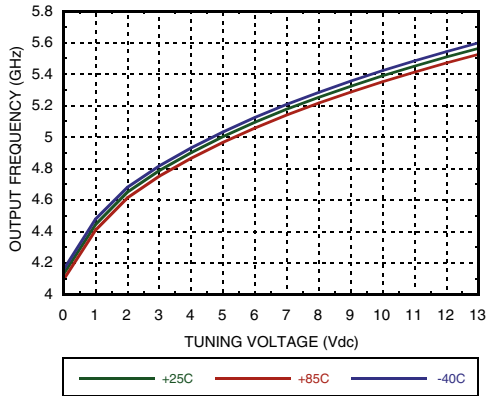

### RFOUT/2 Output Power vs. Tuning Voltage

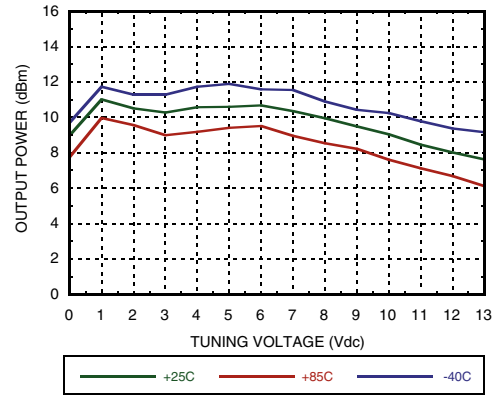

### Divide-by-4 Frequency vs. Tuning Voltage

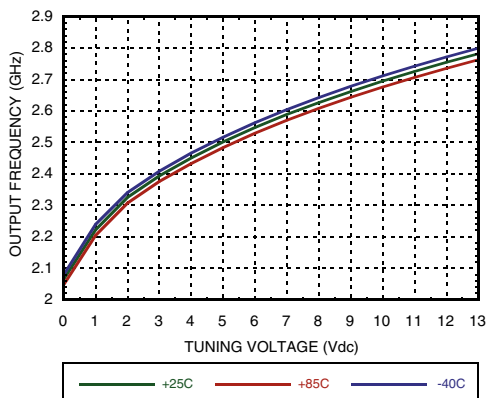

### Divide-by-4 Output Power vs. Tuning Voltage

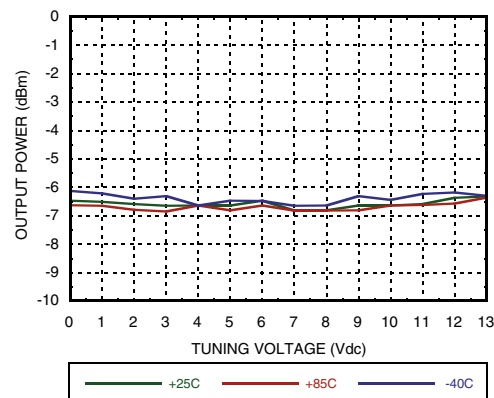

### Absolute Maximum Ratings

Vcc(Dig), Vcc(Amp), Vcc(RF)	+5.5 Vdc
Vtune	0 to +15V
Storage Temperature	-65 to +150 °C

### Reliability Information

Junction Temperature to Maintain 1 Million Hour MTTF	135 °C
Nominal Junction Temperature (T = 85 °C)	123 °C
Thermal Resistance (junction to ground paddle)	23 °C/W
Operating Temperature	-40 to +85 °C



ELECTROSTATIC SENSITIVE DEVICE  
OBSERVE HANDLING PRECAUTIONS

### Typical Supply Current vs. Vcc

Vcc (V)	Icc (mA)
4.75	300
5.00	330
5.25	360

Note: VCO will operate over full voltage range shown above.

## MMIC VCO WITH HALF FREQUENCY OUTPUT 9.6 - 10.8 GHz



### Outline Drawing

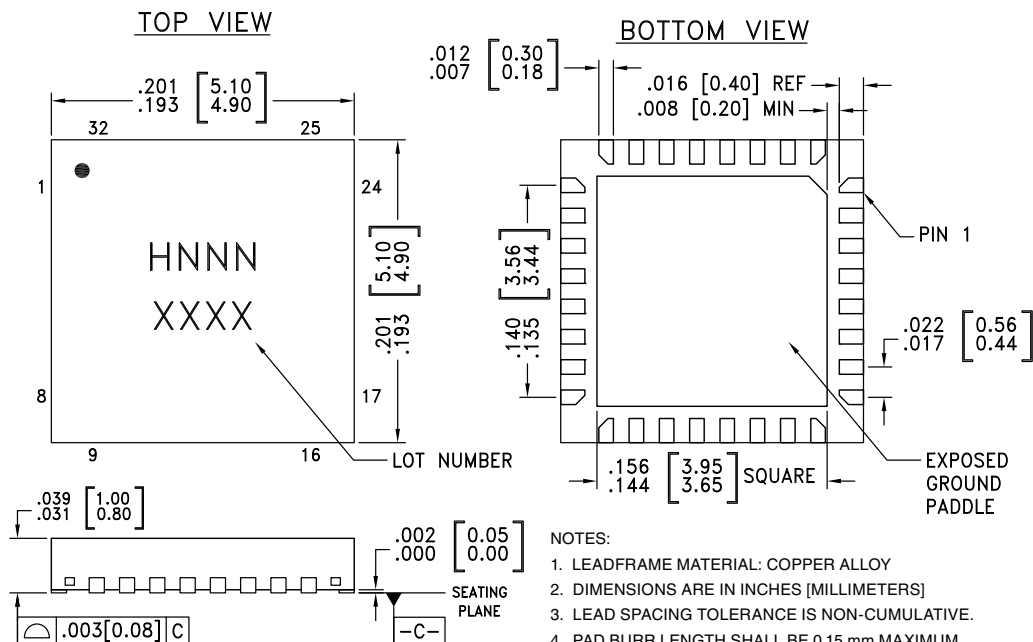

### Package Information

Part Number	Package Body Material	Lead Finish	MSL Rating	Package Marking <sup>[3]</sup>
HMC512LP5	Low Stress Injection Molded Plastic	Sn/Pb Solder	MSL3 <sup>[1]</sup>	H512 XXXX
HMC512LP5E	RoHS-compliant Low Stress Injection Molded Plastic	100% matte Sn	MSL3 <sup>[2]</sup>	H512 XXXX

[1] Max peak reflow temperature of 235 °C

[2] Max peak reflow temperature of 260 °C

[3] 4-Digit lot number XXXX

### Pin Descriptions

Pin Number	Function	Description	Interface Schematic
1 - 3, 8 - 10, 13 - 18, 20, 22 - 28, 30 - 32	N/C	No Connection. These pins may be connected to RF/DC ground. Performance will not be affected.	
4	RFOUT/4	Divide-by-4 output. DC block required.	
6	Vcc (Dig)	Supply voltage for prescaler. If prescaler is not required, this pin may be left open to conserve approximately 65 mA of current.	

## MMIC VCO WITH HALF FREQUENCY OUTPUT 9.6 - 10.8 GHz



### Pin Descriptions

Pin Number	Function	Description	Interface Schematic
7	Vcc (Amp)	Supply voltage for RFOUT/2 output. If RFOUT/2 is not required, this pin may be left open to conserve approximately 30 mA of current.	
12	RFOUT/2	Half frequency output (AC coupled).	
19	RF OUT	RF output (AC coupled).	
21	Vcc (RF)	Supply Voltage, +5V	
29	VTUNE	Control voltage and modulation input. Modulation bandwidth dependent on drive source impedance. See "Determining the FM Bandwidth of a Wideband Varactor Tuned VCO" application note.	
5, 11, Paddle	GND	Package bottom has an exposed metal paddle that must be connected to RF/DC ground.	

### Typical Application Circuit

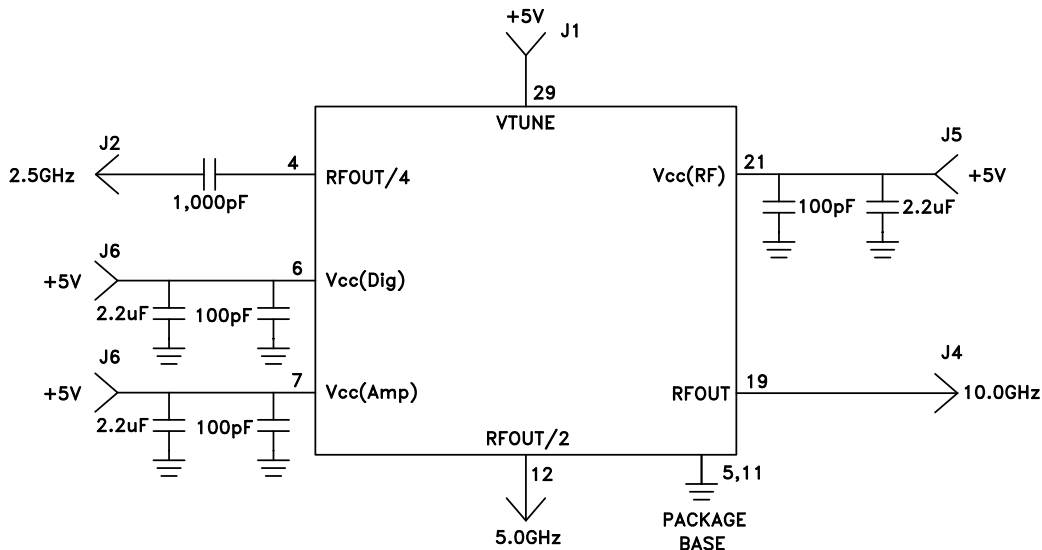

Information furnished by Analog Devices is believed to be accurate and reliable. However, no responsibility is assumed by Analog Devices for its use, nor for any infringements of patents or other rights of third parties that may result from its use. Specifications subject to change without notice. No license is granted by implication or otherwise under any patent or patent rights of Analog Devices. Trademarks and registered trademarks are the property of their respective owners.

For price, delivery, and to place orders: Analog Devices, Inc., One Technology Way, P.O. Box 9106, Norwood, MA 02062-9106 Phone: 781-329-4700 • Order online at [www.analog.com](http://www.analog.com) Application Support: Phone: 1-800-ANALOG-D

**MMIC VCO WITH HALF FREQUENCY OUTPUT  
9.6 - 10.8 GHz**



**Evaluation PCB**

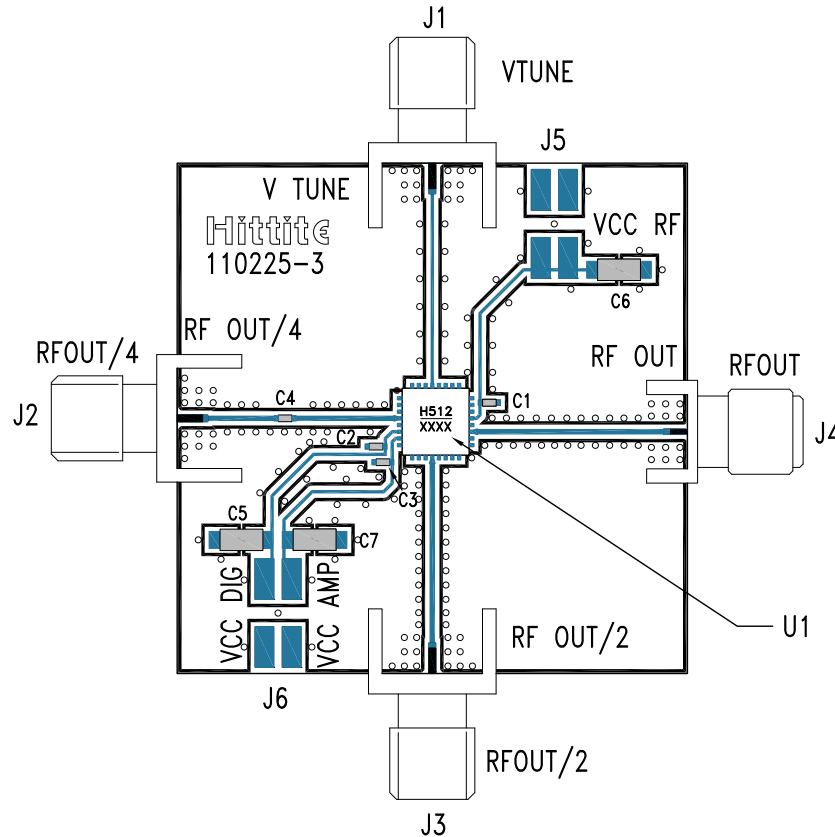

**List of Materials for Evaluation PCB 110227 [1]**

Item	Description
J1 - J4	PCB Mount SMA RF Connector
J5 - J6	2 mm DC Header
C1 - C3	100 pF Capacitor, 0402 Pkg.
C4	1,000 pF Capacitor, 0402 Pkg.
C5 - C7	2.2 μF Tantalum Capacitor
U1	HMC512LP5 / HMC512LP5E VCO
PCB [2]	110225 Eval Board

[1] Reference this number when ordering complete evaluation PCB

[2] Circuit Board Material: Rogers 4350

The circuit board used in the application should use RF circuit design techniques. Signal lines should have 50 Ohm impedance while the package ground leads and backside ground paddle should be connected directly to the ground plane similar to that shown. A sufficient number of via holes should be used to connect the top and bottom ground planes. The evaluation circuit board shown is available from Hittite upon request.

## Данный компонент на территории Российской Федерации

### Вы можете приобрести в компании MosChip.

Для оперативного оформления запроса Вам необходимо перейти по данной ссылке:

<http://moschip.ru/get-element>

Вы можете разместить у нас заказ для любого Вашего проекта, будь то серийное производство или разработка единичного прибора.

В нашем ассортименте представлены ведущие мировые производители активных и пассивных электронных компонентов.

Нашей специализацией является поставка электронной компонентной базы двойного назначения, продукции таких производителей как XILINX, Intel (ex.ALTERA), Vicor, Microchip, Texas Instruments, Analog Devices, Mini-Circuits, Amphenol, Glenair.

Сотрудничество с глобальными дистрибьюторами электронных компонентов, предоставляет возможность заказывать и получать с международных складов практически любой перечень компонентов в оптимальные для Вас сроки.

На всех этапах разработки и производства наши партнеры могут получить квалифицированную поддержку опытных инженеров.

Система менеджмента качества компании отвечает требованиям в соответствии с ГОСТ Р ИСО 9001, ГОСТ РВ 0015-002 и ЭС РД 009

### Офис по работе с юридическими лицами:

105318, г.Москва, ул.Щербаковская д.3, офис 1107, 1118, ДЦ «Щербаковский»

Телефон: +7 495 668-12-70 (многоканальный)

Факс: +7 495 668-12-70 (доб.304)

E-mail: [info@moschip.ru](mailto:info@moschip.ru)

Skype отдела продаж:

moschip.ru

moschip.ru\_4

moschip.ru\_6

moschip.ru\_9