

LOW COST, SNAP-IN TOGGLE FOR WET & DUSTY ENVIRONMENTS, 1 & 2 POLES

The K4 series snap-in toggle switches are rugged, high performance sealed switches designed for use under severe conditions found in marine, appliance, heavy equipment and industrial control applications. They are totally sealed so the switch can withstand direct water spray and submersion, even during operation. Sealed to IP68S with an optional panel seal available, the K4 is also sealed to IP69K.

The K4 series is offered in single and double pole configurations. Toggle action includes 2 and 3-position, momentary and maintained operation in a combination of 13 variations.

Mounting is simple and quick; snaps into panel from the front. The OTTO snap-in design supports a variety of panel thicknesses with just one cutout size specified.

Existing unsealed applications are easily upgraded to sealed functionality because the K series drops into existing panel cutouts.

A choice of models are offered to handle current from 16 amps to low level electronic switching levels.



Single & Double Pole

LED, Neon or
Incandescent Illumination

Features:

- Withstands direct water spray
- Sealed to IP68S and IP69K
- Fits industry standard panel openings for drop-in replacement of panel sealed & unsealed switches
- Snap-in feature accommodates a wide range of panel cutouts
- Switches up to 16 amps
- UV & solvent resistant
- Withstands extreme shock & vibration
- Legends & illuminated function indicators available
- 2 & 3-position, momentary, maintained action & center OFF
- RoHS/WEEE/Reach compliant

Standard Characteristics/Ratings:		
ELECTRICAL RATINGS:		
Load	Sea Level @ 28VDC or 125/250VAC, 60Hz	Cycles
Resistive	16A	25,000
Resistive	10A	50,000
Inductive	10A	25,000
Lamp	5A	25,000
Motor	0.5HP	25,000
DVV	1050Vrms except across light terminals	
Low Level	10mA @ 30mV	100,000
Electrical Life:	See Rating Chart	
LIGHTING:		
Light Source	Rating	
Incandescent	(VDC) 6V, 12V, 24V	
Neon	(VAC) 125V, 250V	
LED	(VDC) 2V, 6V, 12V, 24V	
Mechanical Life:	100,000 cycles	
Seal:	IP68S and IP69K	
Operating Temp Range:	-30°C to +85°C	
MATERIALS:		
Case:	Thermoplastic	
Toggle:	Stainless steel	
Terminals/Contact:	Brass, silver alloy with silver plate, gold plate for low level	
Terminal Hardware:	Screws and lockwashers provided when applicable K4 series recommended Quick Connect terminals: AMP 60253-2 for 12-16 AWG AMP 42100-2 for 14-18 AWG	
Mounting Hardware:	None provided	

SEALED, ILLUMINATED SNAP-IN TOGGLE

K4
SNAP-IN
TOGGLES

LOW COST, SNAP-IN TOGGLE FOR WET & DUSTY ENVIRONMENTS, 1 & 2 POLES

ROCKER SWITCHES

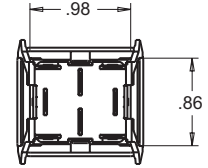
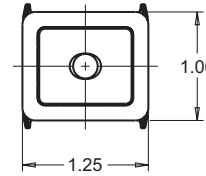
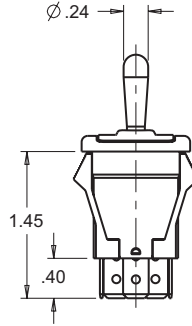
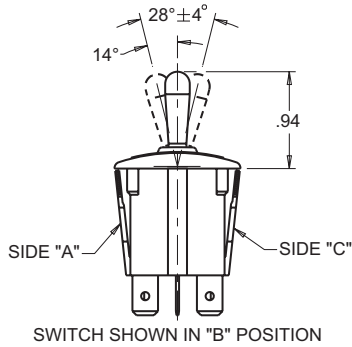
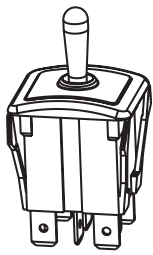

SWITCH SHOWN IN "B" POSITION

TERMINAL STYLES (.032 THICK)		
SCREW	QUICK CONNECT	SOLDER

MOUNTING OPENING: (J)
 PANEL THICKNESS RANGE OF .025 - .105 A GASKET IS RECOMMENDED
 PANEL THICKNESS RANGE OF .105 - .187 W/O GASKET
 PANEL OPENING: MIN. TYP. MAX.
 WIDTH .870 .937 1.000
 LENGTH 1.072 1.099 1.125

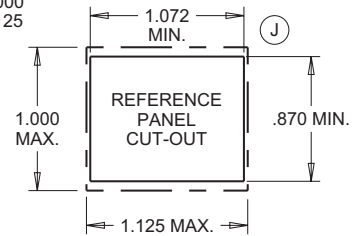

K4 SERIES PART NUMBER CODE

K4	X	X	X	X	X	X	X	X
Terminal Style/ Switch Style	Actuator Style	Switch Action/Circuit			Circuit	Light Type		Legend & Orientation □
A. Quick Connect/ Standard	A. Bat Handle	Position "A"	Position "B"	Position "C"		Position "A"	Position "B"	A. No Legend
B. Screw/Standard		A. 1-C1	NONE	OFF	SPST	A. No Lens	A. No Lens	B. Red
C. Solder/Standard		B. 1-C1	NONE	2-C1	SPDT	B. Red	B. Red	C. Green
D. Quick Connect/ Low Level		C. (1-C1)	NONE	OFF	SPST	C. Green	C. Green	D. Amber
E. Screw/Low Level		D. (1-C1)	NONE	2-C1	SPDT	D. Amber	D. Amber	E. Clear
F. Solder/Low Level		E. (1-C1)	OFF	(2-C1)	SPDT	E. Clear	E. Clear	
		F. 1-C1	OFF	2-C1	DPST			
		G. (1-C1)	OFF	2-C1	DPST			
		H. 1-C1/3-C2	NONE	OFF	DPDT			
		J. 1-C1/3-C2	NONE	2-C1/4-C2	DPDT			
		K. (1-C1)/(3-C2)	NONE	OFF	DPST			
		L. (1-C1)/(3-C2)	NONE	2-C1/4-C2	DPDT			
		M. (1-C1)/(3-C2)	OFF	(2-C1)/(4-C2)	DPDT			
		N. 1-C1/3-C2	OFF	2-C1/4-C2	DPDT			
		P. (1-C1)/(3-C2)	OFF	2-C1/4-C2	DPDT			

NOTE: Contact factory for panel recommendations on switches with potting cups.

NOTE: () denotes momentary action.

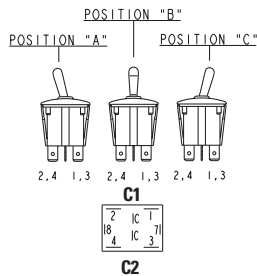

Optional Panel Gasket:
 P/N 807038-1 0.062" thickness
 P/N 807038-2 0.031" thickness

K4 Connector P/N C801765

ORDERING INFORMATION

Example: K4AAKEEABA specifies Q.C. terminals, standard rating; bat handle; DPST two position momentary ON, maintained OFF; 125VAC neon light; clear lens in positions "A", no lens in position "C"; dependent light ON in position "A", wired to terminals 1 & 7; no legend.

• K4 panel plugs available as shown on page 167.

- NOTES:**
- No momentary switches with dependent lights.
 - Neon lamps only to be coded with clear or amber lenses.
 - LED lenses must be clear or same color as LED.
 - No legends on lamp side of switch.
 - No dependent light in OFF positions.
 - All legends printed on actuators without lens(es) will be white except actuator codes C, F, J, M & R.
 - All legends printed on lenses will be white except on clear lens(es) will be black.

A. No Light

B. Dependent Light ON in position "A" Wired to terms 1 & 7

G. Dependent Light ON in position "A" Wired to terms 1 & 7

C. Dependent Light ON in position "C" Wired to terms 2 & 8

H. Independent Light at position "A" Wired to terms 7 & 8

D. Independent Light at position "A" Wired to terms 7 & 8

J. Independent Light at position "A" Wired to terms 3 & 7

F. Dependent Light ON in position "C" Wired to terms 4 & 8

E. Independent Light at position "A" Wired to terms 7 & 8

K. Independent Light at position "C" Wired to terms 4 & 8

L. Independent Light at position "C" Wired to terms 4 & 8

M. Independent Light at position "C" Wired to terms 4 & 8

N. Independent Light at position "C" Wired to terms 4 & 8

P. Independent Light at position "C" Wired to terms 4 & 8

R. Independent Light at position "C" Wired to terms 4 & 8

NOTE: LED anode (+) terminal number shown in **bold**.

D = Dependent Light
I = Independent Light

① All legends are white. Legend cannot be on the same side as the lens.

K4 SCHEMATICS

<p>K4_A_A_ SPST - ON-NONE-OFF SCHEMATIC</p>	<p>K4_B_A_ SPST - ON-NONE-ON SCHEMATIC</p>	<p>K4_C_A_ SPST - (ON)-NONE-OFF SCHEMATIC</p>	<p>K4_D_A_ SPDT - (ON)-NONE-ON SCHEMATIC</p>	<p>K4_E_A_ SPDT - (ON)-OFF-(ON) SCHEMATIC</p>	<p>K4_F_A_ SPDT - ON-OFF-ON SCHEMATIC</p>
<p>K4_G_A_ SPDT - (ON)-OFF-ON SCHEMATIC</p>	<p>K4_H_A_ DPST - ON-NONE-OFF SCHEMATIC</p>	<p>K4_J_A_ DPDT - ON-NONE-ON SCHEMATIC</p>	<p>K4_K_A_ DPST - (ON)-NONE-OFF SCHEMATIC</p>	<p>K4_L_A_ DPDT - (ON)-NONE-ON SCHEMATIC</p>	<p>K4_M_A_ DPDT - (ON)-OFF-(ON) SCHEMATIC</p>
<p>K4_N_A_ DPDT - ON-OFF-ON SCHEMATIC</p>	<p>K4_P_A_ DPDT - (ON)-OFF-ON SCHEMATIC</p>	<p>GENERAL SCHEMATIC INFORMATION</p> <p>○ INDICATES MAINTAIN ACTION (FIXED POSITION)</p> <p>◀ INDICATES MOMENTARY ACTION (AUTOMATIC RETURN POSITION)</p>		<p>K4_F_B_ SPDT - ON-OFF-ON SCHEMATIC W/DEP LED IN "A"</p>	<p>K4_F_C_ SPDT - ON-OFF-ON SCHEMATIC W/DEP LED IN "C"</p>
<p>K4_F_D_ SPDT - ON-OFF-ON SCHEMATIC W/IND LED IN "A"</p>	<p>K4_F_E_ SPDT - ON-OFF-ON SCHEMATIC W/IND LED IN "C"</p>	<p>K4_F_F_ SPDT - ON-OFF-ON SCHEMATIC W/DEP LED IN "A" "C"</p>	<p>K4_F_G_ SPDT - ON-OFF-ON SCHEMATIC W/DEP LED IN "A" IND LED IN "C"</p>	<p>K4_F_H_ SPDT - ON-OFF-ON SCHEMATIC W/IND LED IN "A" DEP LED IN "C"</p>	<p>K4_F_J_ SPDT - ON-OFF-ON SCHEMATIC W/IND LED IN "A" IND LED IN "C"</p>
<p>K4_F_B_ SPDT - ON-OFF-ON SCHEMATIC W/DEP NEON BULB IN "A"</p>	<p>K4_F_C_ SPDT - ON-OFF-ON SCHEMATIC W/DEP NEON BULB IN "C"</p>	<p>K4_F_D_ SPDT - ON-OFF-ON SCHEMATIC W/IND NEON BULB IN "A"</p>	<p>K4_F_E_ SPDT - ON-OFF-ON SCHEMATIC W/IND NEON BULB IN "C"</p>	<p>K4_F_F_ SPDT - ON-OFF-ON SCHEMATIC W/DEP NEON BULB IN "A" "C"</p>	<p>K4_F_G_ SPDT - ON-OFF-ON SCHEMATIC W/DEP NEON IN "A" IND NEON IN "C"</p>
<p>K4_F_H_ SPDT - ON-OFF-ON SCHEMATIC W/IND NEON IN "A" DEP NEON IN "C"</p>	<p>K4_F_J_ SPDT - ON-OFF-ON SCHEMATIC W/IND NEON IN "A" "C" IND NEON IN "C"</p>	<p>K4_F_B_ SPDT - ON-OFF-ON SCHEMATIC W/DEP BULB IN "A"</p>	<p>K4_F_C_ SPDT - ON-OFF-ON SCHEMATIC W/DEP BULB IN "C"</p>	<p>K4_F_D_ SPDT - ON-OFF-ON SCHEMATIC W/IND BULB IN "A"</p>	
<p>K4_F_E_ SPDT - ON-OFF-ON SCHEMATIC W/IND BULB IN "C"</p>	<p>K4_F_F_ SPDT - ON-OFF-ON SCHEMATIC W/DEP BULB IN "A" "C"</p>	<p>K4_F_G_ SPDT - ON-OFF-ON SCHEMATIC W/DEP BULB IN "A" IND BULB IN "C"</p>	<p>K4_F_H_ SPDT - ON-OFF-ON SCHEMATIC W/IND BULB IN "A" DEP BULB IN "C"</p>	<p>K4_F_J_ SPDT - ON-OFF-ON SCHEMATIC W/IND BULB IN "A" IND BULB IN "C"</p>	<p>UNLESS OTHERWISE SPECIFIED DIMENSIONS ARE IN INCHES. TOLERANCES ARE AS LISTED. MUST BE FREE FROM BURRS AND SHARP EDGES</p> <p>TOLERANCES XX ±.03 .XXX ±.010 ANGLES ±2° DO NOT SCALE DRAWING</p>

Данный компонент на территории Российской Федерации

Вы можете приобрести в компании MosChip.

Для оперативного оформления запроса Вам необходимо перейти по данной ссылке:

<http://moschip.ru/get-element>

Вы можете разместить у нас заказ для любого Вашего проекта, будь то серийное производство или разработка единичного прибора.

В нашем ассортименте представлены ведущие мировые производители активных и пассивных электронных компонентов.

Нашей специализацией является поставка электронной компонентной базы двойного назначения, продукции таких производителей как XILINX, Intel (ex.ALTERA), Vicor, Microchip, Texas Instruments, Analog Devices, Mini-Circuits, Amphenol, Glenair.

Сотрудничество с глобальными дистрибьюторами электронных компонентов, предоставляет возможность заказывать и получать с международных складов практически любой перечень компонентов в оптимальные для Вас сроки.

На всех этапах разработки и производства наши партнеры могут получить квалифицированную поддержку опытных инженеров.

Система менеджмента качества компании отвечает требованиям в соответствии с ГОСТ Р ИСО 9001, ГОСТ РВ 0015-002 и ЭС РД 009

Офис по работе с юридическими лицами:

105318, г.Москва, ул.Щербаковская д.3, офис 1107, 1118, ДЦ «Щербаковский»

Телефон: +7 495 668-12-70 (многоканальный)

Факс: +7 495 668-12-70 (доб.304)

E-mail: info@moschip.ru

Skype отдела продаж:

moschip.ru

moschip.ru_4

moschip.ru_6

moschip.ru_9