

*RoHS COMPLIANT



BOURNS®

Features

- High grade, long life
- Single and dual gang
- Assortment of resistance tapers
- Tracking error within ±3 dB
- 45, 60 and 100 mm sizes
- Wide operating temperature range
- T-bar lever option



PTS Series High Grade Slide Potentiometer

Electrical Characteristics

Standard Resistance Range 1K ohms to 1 megohm
 Standard Resistance Tolerance... ±20 %
 End Resistance 1 ohm max.
 Insulation Resistance @ 500 VDC 100 megohms min.
 Dielectric Withstanding Voltage 1000 VAC
 Tracking Error ±3 dB
 Standard Taper Linear, Audio
 Power Rating
 Linear 0.5 watt
 Audio 0.25 watt
 Slider Noise 60 mV max.

Environmental Characteristics

Operational Life 100,000 cycles
 TR Shift ±15 %
 Operating Temperature Range -10 °C to +55 °C
 Resistance to Solder Heat..... ±5 %

Mechanical Characteristics

Mechanical Travel..... Length ±0.5 mm
 Operating Force 60 gf
 Stop Strength 5 kgf min.
 Shaft Axial Force 10 kgf min.
 Shaft Wobble.. 2(2 x L/25) mm p-p max.
 Soldering Condition
 Manual300 °C ±5 °C for 3 sec.
 Wave260 °C ±5 °C for 5 sec.
 WashNot recommended

Product Dimensions

**45 mm Length of Travel
Lever End Style "A"**



Standard Resistance Table

Resistance (Ohms)	Resistance Code
1,000	102
2,000	202
5,000	502
10,000	103
20,000	203
50,000	503
100,000	104
200,000	204
500,000	504
1,000,000	105

How To Order

PTS 45 - 0 2 L - 103 B2

Model Number Designator
 PTS = High Grade Slide Potentiometer

Length of Travel
 45 = 45 mm
 60 = 60 mm
 01 = 100 mm

Lever End Style/Length
 0 = Lever End Style "A" / 15 mm
 1 = Lever End Style "T" / 8.2 mm
 2 = Lever End Style "A" / 20 mm

No. of Gangs
 1 = Single Gang
 2 = Dual Gang

Mounting Type
 L = Solder Lugs
 P = PC Pins

Resistance Code (See Standard Resistance Table)

Resistance Taper (See Taper Charts)
 Taper Series followed by Curve Number

*RoHS Directive 2002/95/EC Jan 27 2003 including Annex
 Specifications are subject to change without notice.
 Customers should verify actual device performance in their specific applications.

Applications

- Professional mixing consoles
- Professional outboard gear

PTS Series High Grade Slide Potentiometer

BOURNS®

Product Dimensions

60 mm Length of Travel
Lever End Style "A"



Tapers

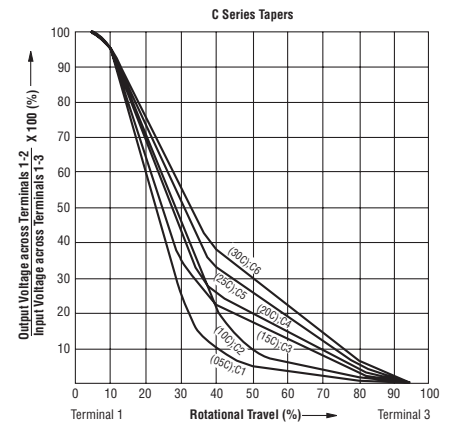
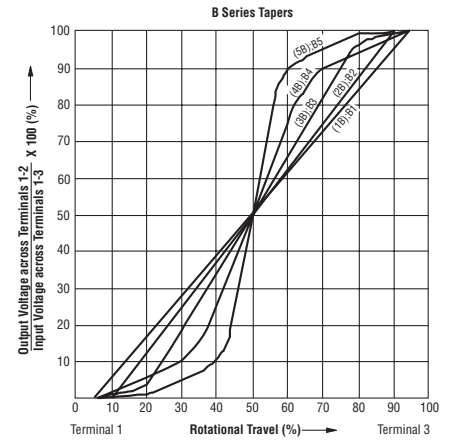
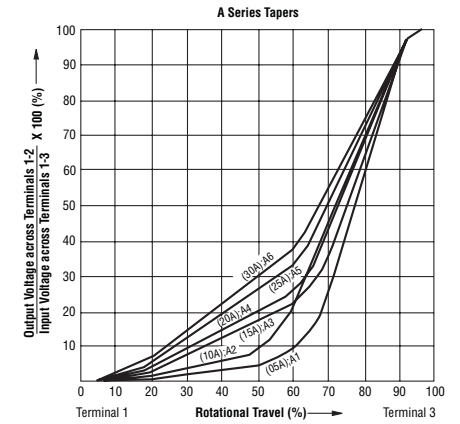

Schematics

Single Gang



Dual Gang



Specifications are subject to change without notice.
Customers should verify actual device performance in their specific applications.

PTS Series High Grade Slide Potentiometer

BOURNS®

Product Dimensions

100 mm Length of Travel
Lever End Style "A"

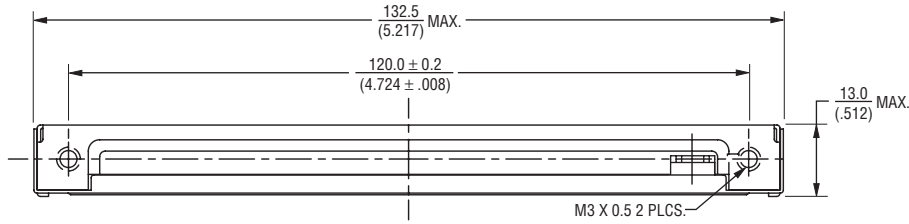

Lever Length
15.0 (.591)
20.0 (.787)

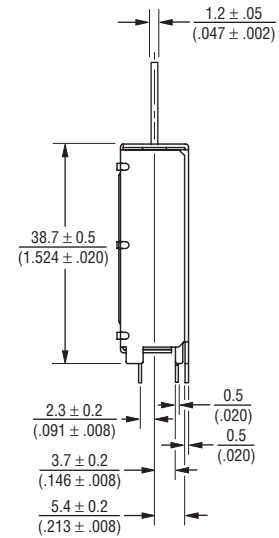
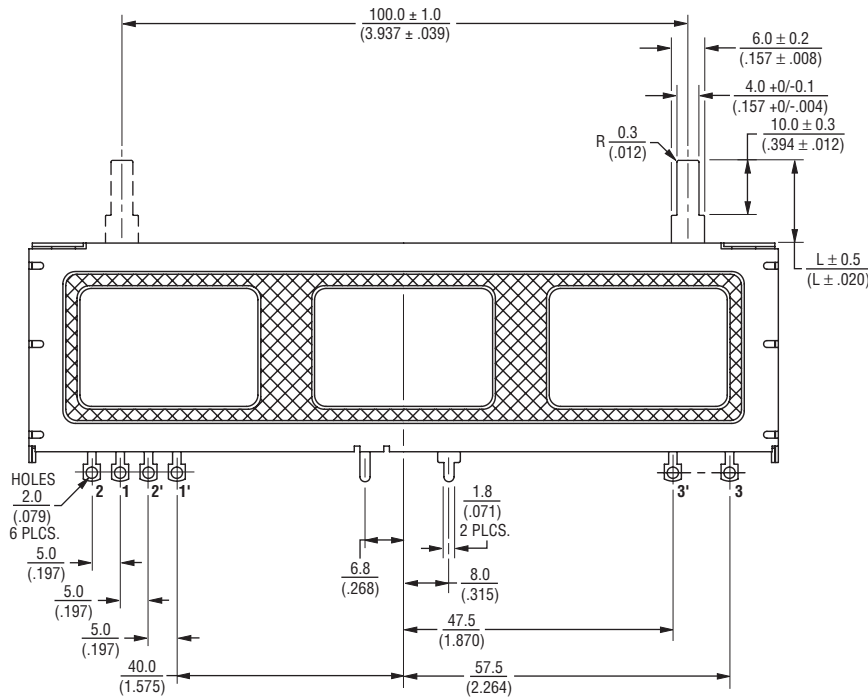

DIMENSIONS: $\frac{\text{MM}}{\text{(INCHES)}}$

PTS Series High Grade Slide Potentiometer



Product Dimensions

45 mm Length of Travel
Lever End Style "T"

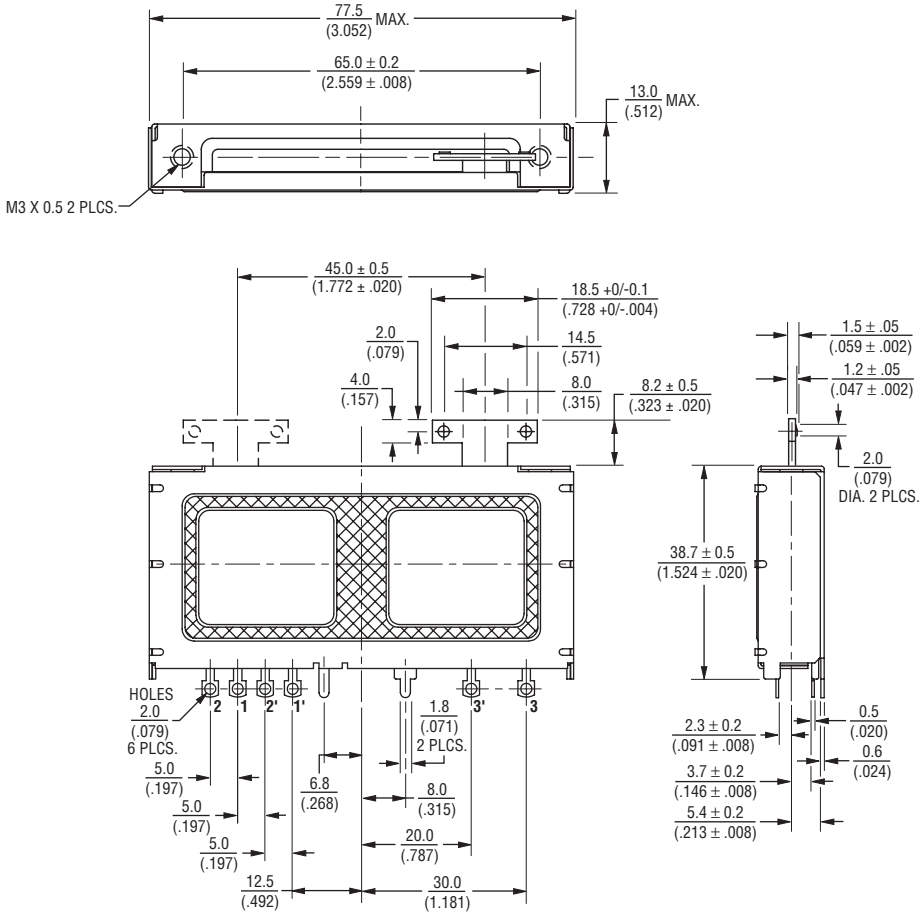

DIMENSIONS: $\frac{\text{MM}}{\text{(INCHES)}}$

PTS Series High Grade Slide Potentiometer

BOURNS®

Product Dimensions

60 mm Length of Travel
Lever End Style "T"



Specifications are subject to change without notice.
Customers should verify actual device performance in their specific applications.

PTS Series High Grade Slide Potentiometer

BOURNS®

Product Dimensions

100 mm Length of Travel
Lever End Style "T"



DIMENSIONS: $\frac{\text{MM}}{\text{(INCHES)}}$

Данный компонент на территории Российской Федерации

Вы можете приобрести в компании MosChip.

Для оперативного оформления запроса Вам необходимо перейти по данной ссылке:

<http://moschip.ru/get-element>

Вы можете разместить у нас заказ для любого Вашего проекта, будь то серийное производство или разработка единичного прибора.

В нашем ассортименте представлены ведущие мировые производители активных и пассивных электронных компонентов.

Нашей специализацией является поставка электронной компонентной базы двойного назначения, продукции таких производителей как XILINX, Intel (ex.ALTERA), Vicor, Microchip, Texas Instruments, Analog Devices, Mini-Circuits, Amphenol, Glenair.

Сотрудничество с глобальными дистрибьюторами электронных компонентов, предоставляет возможность заказывать и получать с международных складов практически любой перечень компонентов в оптимальные для Вас сроки.

На всех этапах разработки и производства наши партнеры могут получить квалифицированную поддержку опытных инженеров.

Система менеджмента качества компании отвечает требованиям в соответствии с ГОСТ Р ИСО 9001, ГОСТ РВ 0015-002 и ЭС РД 009

Офис по работе с юридическими лицами:

105318, г.Москва, ул.Щербаковская д.3, офис 1107, 1118, ДЦ «Щербаковский»

Телефон: +7 495 668-12-70 (многоканальный)

Факс: +7 495 668-12-70 (доб.304)

E-mail: info@moschip.ru

Skype отдела продаж:

moschip.ru

moschip.ru_4

moschip.ru_6

moschip.ru_9