



Table of Contents-

1.	GENERAL DESCRIPTION	6
2.	FEATURES	6
3.	ORDER INFORMATION	6
4.	BALL CONFIGURATION	7
5.	BALL DESCRIPTION	8
5.1	Basic Functionality	8
5.2	Addressing Table	9
6.	BLOCK DIAGRAM	10
7.	FUNCTIONAL DESCRIPTION	11
7.1	Simplified LPDDR2 State Diagram	11
7.1.1	Simplified LPDDR2 Bus Interface State Diagram	12
7.2	Power-up, Initialization, and Power-Off	13
7.2.1	Power Ramp and Device Initialization	13
7.2.2	Timing Parameters for Initialization	15
7.2.3	Power Ramp and Initialization Sequence	15
7.2.4	Initialization after Reset (without Power ramp)	16
7.2.5	Power-off Sequence	16
7.2.6	Timing Parameters Power-Off	16
7.2.7	Uncontrolled Power-Off Sequence	16
7.3	Mode Register Definition	17
7.3.1	Mode Register Assignment and Definition	17
7.3.1.1	Mode Register Assignment	17
7.3.2	MR0_Device Information (MA[7:0] = 00H)	18
7.3.3	MR1_Device Feature 1 (MA[7:0] = 01H)	18
7.3.3.1	Burst Sequence by Burst Length (BL), Burst Type (BT), and Warp Control (WC)	19
7.3.3.2	Non Wrap Restrictions	19
7.3.4	MR2_Device Feature 2 (MA[7:0] = 02H)	20
7.3.5	MR3_I/O Configuration 1 (MA[7:0] = 03H)	20
7.3.6	MR4_Device Temperature (MA[7:0] = 04H)	20
7.3.7	MR5_Basic Configuration 1 (MA[7:0] = 05H)	21
7.3.8	MR6_Basic Configuration 2 (MA[7:0] = 06H)	21
7.3.9	MR7_Basic Configuration 3 (MA[7:0] = 07H)	21
7.3.10	MR8_Basic Configuration 4 (MA[7:0] = 08H)	21
7.3.11	MR9_Test Mode (MA[7:0] = 09H)	21
7.3.12	MR10_Calibration (MA[7:0] = 0AH)	22
7.3.13	MR16_PASR_Bank Mask (MA[7:0] = 10H)	22
7.3.14	MR17_PASR_Segment Mask (MA[7:0] = 11H)	23
7.3.15	MR32_DQ Calibration Pattern A (MA[7:0] = 20H)	23
7.3.16	MR40_DQ Calibration Pattern B (MA[7:0] = 28H)	23
7.3.17	MR63_Reset (MA[7:0] = 3FH): MRW only	23
7.4	Command Definitions and Timing Diagrams	24
7.4.1	Activate Command	24
7.4.1.1	Activate Command Cycle: tRCD = 3, tRP = 3, tRRD = 2	24
7.4.1.2	tFAW Timing	25
7.4.1.3	Command Input Setup and Hold Timing	25
7.4.1.4	CKE Input Setup and Hold Timing	26
7.4.2	Read and Write Access Modes	26
7.4.3	Burst Read Command	26
7.4.3.1	Data Output (Read) Timing (tDQSCkmax)	27
7.4.3.2	Data Output (Read) Timing (tDQSCkmin)	28
7.4.3.3	Burst Read: RL = 5, BL = 4, tDQSCk > tCK	28
7.4.3.4	Burst Read: RL = 3, BL = 8, tDQSCk < tCK	29



7.4.3.5	LPDDR2: tDQSKDL Timing.....	29
7.4.3.6	LPDDR2: tDQSKDM Timing.....	30
7.4.3.7	LPDDR2: tDQSKDS Timing.....	30
7.4.3.8	Burst Read Followed by Burst Write: RL = 3, WL = 1, BL = 4.....	31
7.4.3.9	Seamless Burst Read: RL = 3, BL = 4, tCCD = 2.....	31
7.4.4	Reads Interrupted by a Read.....	32
7.4.4.1	Read Burst Interrupt Example: RL = 3, BL = 8, tCCD = 2.....	32
7.4.5	Burst Write Operation.....	32
7.4.5.1	Data Input (Write) Timing.....	33
7.4.5.2	Burst Write: WL = 1, BL = 4.....	33
7.4.5.3	Burst Write Followed by Burst Read: RL = 3, WL = 1, BL = 4.....	34
7.4.5.4	Seamless Burst Write: WL = 1, BL = 4, tCCD = 2.....	34
7.4.6	Writes Interrupted by a Write.....	35
7.4.6.1	Write Burst Interrupt Timing: WL = 1, BL = 8, tCCD = 2.....	35
7.4.7	Burst Terminate.....	35
7.4.7.1	Burst Write Truncated by BST: WL = 1, BL = 16.....	36
7.4.7.2	Burst Read Truncated by BST: RL = 3, BL = 16.....	36
7.4.8	Write Data Mask.....	37
7.4.8.1	Write Data Mask Timing.....	37
7.4.9	Precharge Operation.....	38
7.4.9.1	Bank Selection for Precharge by Address Bits.....	38
7.4.10	Burst Read Operation Followed by Precharge.....	38
7.4.10.1	Burst Read Followed by Precharge: RL = 3, BL = 8, RU(tRTP(min)/tCK) = 2.....	39
7.4.10.2	Burst Read Followed by Precharge: RL = 3, BL = 4, RU(tRTP(min)/tCK) = 3.....	39
7.4.11	Burst Write Followed by Precharge.....	40
7.4.11.1	Burst Write Followed by Precharge: WL = 1, BL = 4.....	40
7.4.12	Auto Precharge Operation.....	41
7.4.13	Burst Read with Auto-Precharge.....	41
7.4.13.1	Burst Read with Auto-Precharge: RL = 3, BL = 4, RU(tRTP(min)/tCK) = 2.....	41
7.4.14	Burst Write with Auto-Precharge.....	42
7.4.14.1	Burst Write with Auto-Precharge: WL = 1, BL = 4.....	42
7.4.14.2	Precharge & Auto Precharge Clarification.....	43
7.4.15	Refresh Command.....	44
7.4.15.1	Command Scheduling Separations Related to Refresh.....	45
7.4.16	LPDDR2 SDRAM Refresh Requirements.....	45
7.4.16.1	Definition of tSRF.....	46
7.4.16.2	Regular, Distributed Refresh Pattern.....	48
7.4.16.3	Allowable Transition from Repetitive Burst Refresh.....	48
7.4.16.4	NOT-Allowable Transition from Repetitive Burst Refresh.....	49
7.4.16.5	Recommended Self-Refresh Entry and Exit.....	49
7.4.16.6	All Bank Refresh Operation.....	50
7.4.16.7	Per Bank Refresh Operation.....	50
7.4.17	Self Refresh Operation.....	51
7.4.18	Partial Array Self-Refresh: Bank Masking.....	52
7.4.19	Partial Array Self-Refresh: Segment Masking.....	52
7.4.20	Mode Register Read Command.....	53
7.4.20.1	Mode Register Read Timing Example: RL = 3, tMRR = 2.....	54
7.4.20.2	Read to MRR Timing Example: RL = 3, tMRR = 2.....	55
7.4.20.3	Burst Write Followed by MRR: RL = 3, WL = 1, BL = 4.....	55
7.4.21	Temperature Sensor.....	56
7.4.21.1	Temperature Sensor Timing.....	57
7.4.21.2	DQ Calibration.....	57
7.4.21.3	MR32 and MR40 DQ Calibration Timing Example: RL = 3, tMRR = 2.....	58
7.4.22	Mode Register Write Command.....	59
7.4.22.1	Mode Register Write Timing Example: RL = 3, tMRW = 5.....	59
7.4.22.2	Truth Table for Mode Register Read (MRR) and Mode Register Write (MRW).....	59



7.4.23	Mode Register Write Reset (MRW Reset)	60
7.4.24	Mode Register Write ZQ Calibration Command	60
7.4.24.1	ZQ Calibration Initialization Timing Example	61
7.4.24.2	ZQ Calibration Short Timing Example	61
7.4.24.3	ZQ Calibration Long Timing Example	62
7.4.24.4	ZQ Calibration Reset Timing Example	62
7.4.24.5	ZQ External Resistor Value, Tolerance, and Capacitive Loading	63
7.4.25	Power-Down	63
7.4.25.1	Basic Power Down Entry and Exit Timing	63
7.4.25.2	CKE Intensive Environment	64
7.4.25.3	Refresh to Refresh Timing with CKE Intensive Environment	64
7.4.25.4	Read to Power-Down Entry	65
7.4.25.5	Read with Auto Precharge to Power-Down Entry	65
7.4.25.6	Write to Power-Down Entry	66
7.4.25.7	Write with Auto Precharge to Power-Down Entry	66
7.4.25.8	Refresh Command to Power-Down Entry	67
7.4.25.9	Activate Command to Power-Down Entry	67
7.4.25.10	Precharge/Precharge-All Command to Power-Down Entry	67
7.4.25.11	Mode Register Read to Power-Down Entry	68
7.4.25.12	MRW Command to Power-Down Entry	68
7.4.26	Deep Power-Down	68
7.4.26.1	Deep Power Down Entry and Exit Timing	69
7.4.27	Input Clock Stop and Frequency Change	69
7.4.28	No Operation Command	70
7.5	Truth Tables	70
7.5.1	Command Truth Table	71
7.5.2	CKE Truth Table	72
7.5.3	Current State Bank n - Command to Bank n Truth Table	73
7.5.4	Current State Bank n - Command to Bank m Truth Table	75
7.5.5	Data Mask Truth Table	76
8.	ELECTRICAL CHARACTERISTIC	77
8.1	Absolute Maximum DC Ratings	77
8.2	AC & DC Operating Conditions	77
8.2.1	Recommended DC Operating Conditions	77
8.2.1.1	Recommended DC Operating Conditions	77
8.2.2	Input Leakage Current	78
8.2.3	Operating Temperature Conditions	78
8.2.4	AC and DC Input Measurement Levels	78
8.2.4.1	AC and DC Logic Input Levels for Single-Ended Signals	78
8.2.4.1.1	Single-Ended AC and DC Input Levels for CA and CS _n Inputs	78
8.2.4.1.2	Single-Ended AC and DC Input Levels for CKE	79
8.2.4.1.3	Single-Ended AC and DC Input Levels for DQ and DM	79
8.2.4.2	Vref Tolerances	79
8.2.4.2.1	VRef(DC) Tolerance and VRef AC-Noise Limits	80
8.2.4.3	Input Signal	81
8.2.4.3.1	LPDDR2-800 Input Signal	81
8.2.4.4	AC and DC Logic Input Levels for Differential Signals	82
8.2.4.4.1	Differential Signal Definition	82
8.2.4.4.2	Differential swing requirements for clock (CK _t - CK _c) and strobe (DQS _t - DQS _c)	82
8.2.4.5	Single-Ended Requirements for Differential Signals	83
8.2.4.6	Differential Input Cross Point Voltage	84
8.2.4.7	Slew Rate Definitions for Single-Ended Input Signals	85
8.2.4.8	Slew Rate Definitions for Differential Input Signals	85
8.2.5	AC and DC Output Measurement Levels	86
8.2.5.1	Single Ended AC and DC Output Levels	86



8.2.5.2	Differential AC and DC Output Levels	86
8.2.5.3	Single Ended Output Slew Rate	86
8.2.5.4	Differential Output Slew Rate	88
8.2.5.5	Overshoot and Undershoot Specifications	89
8.2.6	Output buffer Characteristics	90
8.2.6.1	HSUL_12 Driver Output Timing Reference Load	90
8.2.6.2	RON _{PU} and RON _{PD} Resistor Definition	90
8.2.6.3	RON _{PU} and RON _{PD} Characteristics with ZQ Calibration	91
8.2.6.4	Output Driver Temperature and Voltage Sensitivity	91
8.2.6.5	RON _{PU} and RON _{PD} Characteristics without ZQ Calibration	92
8.2.6.6	RZQ I-V Curve	93
8.2.6.7	Input/Output Capacitance	95
8.3	IDD Specification Parameters and Test Conditions	96
8.3.1	IDD Measurement Conditions	96
8.3.1.1	Definition of Switching for CA Input Signals	96
8.3.1.2	Definition of Switching for IDD4R	97
8.3.1.3	Definition of Switching for IDD4W	97
8.3.2	IDD Specifications	98
8.3.2.1	LPDDR2 IDD Specification Parameters and Operating Conditions, -40°C~85°C (x16, x32)	98
8.3.2.2	IDD6 Partial Array Self-Refresh Current, -40°C~85°C (x16, x32)	100
8.4	Clock Specification	100
8.4.1	Definition for tCK(avg) and nCK	100
8.4.2	Definition for tCK(abs)	100
8.4.3	Definition for tCH(avg) and tCL(avg)	101
8.4.4	Definition for tJIT(per)	101
8.4.5	Definition for tJIT(cc)	101
8.4.6	Definition for tERR(nper)	101
8.4.7	Definition for Duty Cycle Jitter tJIT(duty)	102
8.4.8	Definition for tCK(abs), tCH(abs) and tCL(abs)	102
8.5	Period Clock Jitter	102
8.5.1	Clock Period Jitter Effects on Core Timing Parameters	102
8.5.1.1	Cycle Time De-rating for Core Timing Parameters	102
8.5.1.2	Clock Cycle De-rating for Core Timing Parameters	103
8.5.2	Clock Jitter Effects on Command/Address Timing Parameters	103
8.5.3	Clock Jitter Effects on Read tTiming Parameters	103
8.5.3.1	tRPRE	103
8.5.3.2	tLZ(DQ), tHZ(DQ), tDQSCK, tLZ(DQS), tHZ(DQS)	103
8.5.3.3	tQSH, tQSL	103
8.5.3.4	tRPST	104
8.5.4	Clock Jitter Effects on Write Timing Parameters	104
8.5.4.1	tDS, tDH	104
8.5.4.2	tDSS, tDSH	104
8.5.4.3	tDQSS	104
8.6	Refresh Requirements	105
8.6.1	Refresh Requirement Parameters	105
8.7	AC Timings	106
8.7.1	LPDDR2 AC Timing	106
8.7.2	CA and CS _n Setup, Hold and Derating	111
8.7.2.1	CA and CS _n Setup and Hold Base-Values for 1V/nS	111
8.7.2.2	Derating Values LPDDR2 tIS/tIH - AC/DC Based AC220	112
8.7.2.3	Required Time tVAC above VIH(ac) {below VIL(ac)} for Valid Transition	112
8.7.2.4	Nominal Slew Rate and tVAC for Setup Time tIS for CA and CS _n with Respect to Clock	113
8.7.2.5	Nominal Slew Rate for Hold Time tIH for CA and CS _n with Respect to Clock	114
8.7.2.6	Tangent Line for Setup Time tIS for CA and CS _n with Respect to Clock	115
8.7.2.7	Tangent Line for Hold Time tIH for CA and CS _n with Respect to Clock	116



8.7.3	Data Setup, Hold and Slew Rate Derating	117
8.7.3.1	Data Setup and Hold Base-Values.....	117
8.7.3.2	Derating Values LPDDR2 tDS/tDH - AC/DC Based AC220.....	118
8.7.3.3	Required Time tVAC above VIH(ac) {below VIL(ac)} for Valid Transition.....	118
8.7.3.4	Nominal Slew Rate and tVAC for Setup Time tDS for DQ with Respect to Strobe.....	119
8.7.3.5	Nominal Slew Rate for Hold time tDH for DQ with Respect to Strobe.....	120
8.7.3.6	Tangent Line for Setup Time tDS for DQ with Respect to Strobe	121
8.7.3.7	Tangent Line for Hold Time tDH for DQ with Respect to Strobe	122
9.	PACKAGE DIMENSIONS	123
10.	REVISION HISTORY	124



1. GENERAL DESCRIPTION

LPDDR2 is a high-speed SDRAM device internally configured as an 8-Bank memory. These devices contains 2 Gb has 2,147,483,648 bits.

All LPDDR2 devices use a double data rate architecture on the Command/Address (CA) bus to reduce the number of input pins in the system. The 10-bit CA bus contains command, address, and Bank/Row Buffer information. Each command uses one clock cycle, during which command information is transferred on both the positive and negative edge of the clock.

For LPDDR2 devices, accesses begin with the registration of an Activate command, which is then followed by a Read or Write command. The address and BA bits registered coincident with the Activate command are used to select the row and the Bank to be accessed. The address bits registered coincident with the Read or Write command are used to select the Bank and the starting column location for the burst access.

2. FEATURES

- | | |
|---|---|
| • VDD1 = 1.7~1.95V | • Data mask (DM) for write data |
| • VDD2/VDDCA/VDDQ = 1.14V~1.30V | • Clock Stop capability during idle periods |
| • Data width: x16 / x32 | • Double data rate for data output |
| • Clock rate: up to 400 MHz | • Differential clock inputs |
| • Data rate: up to 800 Mb/s/pin | • Bidirectional differential data strobe |
| • Four-bit prefetch DDR architecture | • Interface: HSUL_12 |
| • Eight internal banks for concurrent operation | • JEDEC LPDDR2-S4B compliance |
| • Programmable READ and WRITE latencies (RL/WL) | • Support package: |
| • Programmable burst lengths: 4, 8, or 16 | Single channel: 134 VFBGA (10mm x11.5mm) |
| • Per Bank Refresh | • Operating Temperature Range: |
| • Partial Array Self-Refresh(PASR) | -25°C ≤ TCASE ≤ 85°C |
| • Deep Power Down Mode (DPD Mode) | -40°C ≤ TCASE ≤ 85°C |
| • Programmable output buffer driver strength | |

3. ORDER INFORMATION

Part Number	VDD1/VDD2/VDDQ	I/O Width	Package	Others
W97BH6LBVX2I	1.8V/1.2V/1.2V	16	134VFBGA	400MHz, -40°C~85°C
W97BH6LBVX2E	1.8V/1.2V/1.2V	16	134VFBGA	400MHz, -25°C~85°C
W97BH2LBVX2I	1.8V/1.2V/1.2V	32	134VFBGA	400MHz, -40°C~85°C
W97BH2LBVX2E	1.8V/1.2V/1.2V	32	134VFBGA	400MHz, -25°C~85°C



4. BALL CONFIGURATION

	1	2	3	4	5	6	7	8	9	10	
A	DNU	DNU							DNU	DNU	A
B	DNU	NC	NC		VDD2	VDD1	DQ31 NC	DQ29 NC	DQ26 NC	DNU	B
C	VDD1	VSS	NC		VSS	VSSQ	VDDQ	DQ25 NC	VSSQ	VDDQ	C
D	VSS	VDD2	ZQ0		VDDQ	DQ30 NC	DQ27 NC	DQS3_t NC	DQS3_c NC	VSSQ	D
E	VSSCA	CA9	CA8		DQ28 NC	DQ24 NC	DM3 NC	DQ15	VDDQ	VSSQ	E
F	VDDCA	CA6	CA7		VSSQ	DQ11	DQ13	DQ14	DQ12	VDDQ	F
G	VDD2	CA5	Vref(CA)		DQS1_c	DQS1_t	DQ10	DQ9	DQ8	VSSQ	G
H	VDDCA	VSS	CK_c		DM1	VDDQ					H
J	VSSCA	NC	CK_t		VSSQ	VDDQ	VDD2	VSS	Vref(DQ)		J
K	CKE0	NC	NC		DM0	VDDQ					K
L	CS0_n	NC	NC		DQS0_c	DQS0_t	DQ5	DQ6	DQ7	VSSQ	L
M	CA4	CA3	CA2		VSSQ	DQ4	DQ2	DQ1	DQ3	VDDQ	M
N	VSSCA	VDDCA	CA1		DQ19 NC	DQ23 NC	DM2 NC	DQ0	VDDQ	VSSQ	N
P	VSS	VDD2	CA0		VDDQ	DQ17 NC	DQ20 NC	DQS2_t NC	DQS2_c NC	VSSQ	P
R	VDD1	VSS	NC		VSS	VSSQ	VDDQ	DQ22 NC	VSSQ	VDDQ	R
T	DNU	NC	NC		VDD2	VDD1	DQ16 NC	DQ18 NC	DQ21 NC	DNU	T
U	DNU	DNU							DNU	DNU	U
	1	2	3	4	5	6	7	8	9	10	

[Top View]

Ball Definition where 2 labe's are present	
1st Row	x32 device
2nd Row	x16 device

	LPDDR2 DQ
	LPDDR2 CA
	Power
	Ground
	Do Not Use /NC
	ZQ
	Clock



5. BALL DESCRIPTION

5.1 Basic Functionality

Name	Type	Description
CK_t, CK_c	Input	Clock: CK_t and CK_c are differential clock inputs. All Double Data Rate (DDR) CA inputs are sampled on both positive and negative edge of CK_t. Single Data Rate (SDR) inputs, CS_n and CKE, are sampled at the positive Clock edge. Clock is defined as the differential pair, CK_t and CK_c. The positive Clock edge is defined by the crosspoint of a rising CK_t and a falling CK_c. The negative Clock edge is defined by the crosspoint of a falling CK_t and a rising CK_c.
CKE	Input	Clock Enable: CKE HIGH activates and CKE LOW deactivates internal clock signals and therefore device input buffers and output drivers. Power savings modes are entered and exited through CKE transitions. CKE is considered part of the command code. See 7.5.1 “ Command Truth Table ” for command code descriptions. CKE is sampled at the positive Clock edge.
CS_n	Input	Chip Select: CS_n is considered part of the command code. See 7.5.1 “ Command Truth Table ” for command code descriptions. CS_n is sampled at the positive Clock edge.
CA[n:0]	Input	DDR Command/Address Inputs: Uni-directional command/address bus inputs. CA is considered part of the command code. See 7.5.1 “ Command Truth Table ” for command code descriptions.
DQ[n:0]	I/O	Data Inputs/Output: Bi-directional data bus. n=15 for 16 bits DQ; n=31 for 32 bits DQ.
DQSn_t, DQSn_c	I/O	Data Strobe (Bi-directional, Differential): The data strobe is bi-directional (used for read and write data) and differential (DQS_t and DQS_c). It is output with read data and input with write data. DQS_t is edge-aligned to read data and centered with write data. For x16, DQS0_t and DQS0_c correspond to the data on DQ0-7; DQS1_t and DQS1_c to the data on DQ8-15. For x32 DQS0_t and DQS0_c correspond to the data on DQ0-7; DQS1_t and DQS1_c to the data on DQ8-15; DQS2_t and DQS2_c to the data on DQ16-23; DQS3_t and DQS3_c to the data on DQ24-31.
DMn	Input	Input Data Mask: DM is the input mask signal for write data. Input data is masked when DM is sampled HIGH coincident with that input data during a Write access. DM is sampled on both edges of DQS_t. Although DM is for input only, the DM loading shall match the DQ and DQS (or DQS_c). DM0 is the input data mask signal for the data on DQ0-7. For x16 and x32 devices, DM1 is the input data mask signal for the data on DQ8-15. For x32 devices, DM2 is the input data mask signal for the data on DQ16-23 and DM3 is the input data mask signal for the data on DQ24-31.
VDD1	Supply	Core Power Supply 1: Power supply for core.
VDD2	Supply	Core Power Supply 2: Power supply for core.
VDDCA	Supply	Input Receiver Power Supply: Power supply for CA[n:0], CKE, CS_n, CK_t, and CK_c input buffers.
VDDQ	Supply	I/O Power Supply: Power supply for Data input/output buffers.
VREF(CA)	Supply	Reference Voltage for CA Command and Control Input Receiver: Reference voltage for all CA[n:0], CKE, CS_n, CK_t, and CK_c input buffers.
VREF(DQ)	Supply	Reference Voltage for DQ Input Receiver: Reference voltage for all Data input buffers.
VSS	Supply	Ground
VSSCA	Supply	Ground for CA Input Receivers
VSSQ	Supply	I/O Ground
ZQ	I/O	Reference Pin for Output Drive Strength Calibration

Note: Data includes DQ and DM.



5.2 Addressing Table

Density		2Gb
Number of Banks		8
Bank Addresses		BA0-BA2
x16	Row Addresses	R0-R13
	Column Addresses* ¹	C0-C9
x32	Row Addresses	R0-R13
	Column Addresses* ¹	C0-C8

Notes:

1. The least-significant column address C0 is not transmitted on the CA bus, and is implied to be zero.
2. Row and Column Address values on the CA bus that are not used are "don't care".



6. BLOCK DIAGRAM

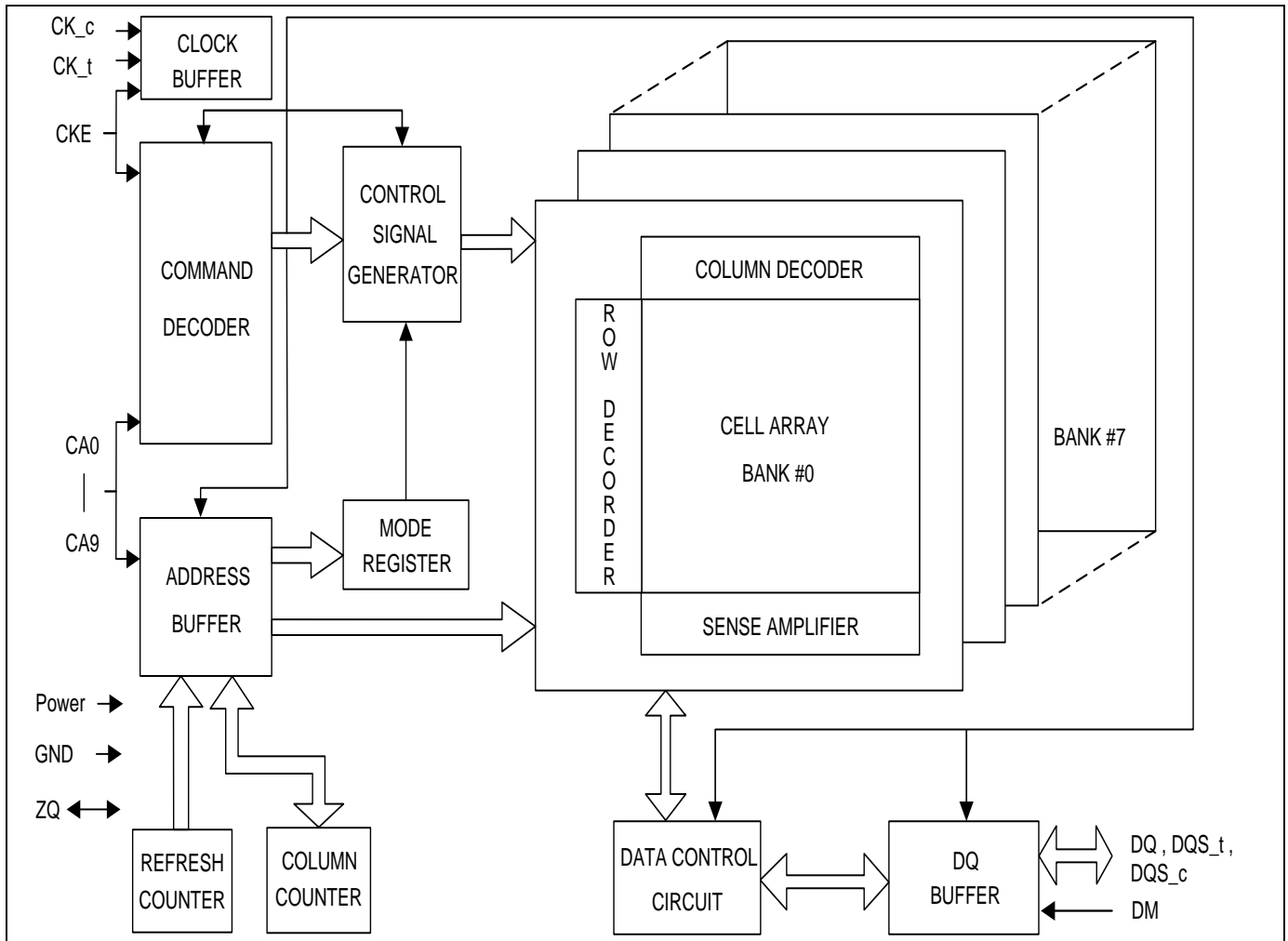



7. FUNCTIONAL DESCRIPTION

LPDDR2-S4 devices use a double data rate architecture on the DQ pins to achieve high speed operation. The double data rate architecture is essentially a 4n prefetch architecture with an interface designed to transfer two data bits per DQ every clock cycle at the I/O pins. A single read or write access for the LPDDR2-S4 effectively consists of a single 4n-bit-wide, one-clock-cycle data transfer at the internal SDRAM core and four corresponding n-bit-wide, one-half-clock-cycle data transfers at the I/O pins.

Read and write accesses are burst oriented; accesses start at a selected location and continue for a programmed number of locations in a programmed sequence.

Prior to normal operation, the LPDDR2 device must be initialized. The following section provides detailed information covering device initialization, register definition, command description and device operation.

7.1 Simplified LPDDR2 State Diagram

LPDDR2-SDRAM state diagram provides a simplified illustration of allowed state transitions and the related commands to control them. For a complete definition of the device behavior, the information provided by the state diagram should be integrated with the truth tables and timing specification.

The truth tables provide complementary information to the state diagram, they clarify the device behavior and the applied restrictions when considering the actual state of all the banks.



7.1.1 Simplified LPDDR2 Bus Interface State Diagram



Note: For LPDDR2-SDRAM in the Idle state, all banks are precharged.



7.2 Power-up, Initialization, and Power-Off

The LPDDR2 Devices must be powered up and initialized in a predefined manner. Operational procedures other than those specified may result in undefined operation.

7.2.1 Power Ramp and Device Initialization

The following sequence shall be used to power up an LPDDR2 device. Unless specified otherwise, these steps are mandatory.

1. Power Ramp

While applying power (after T_a), CKE shall be held at a logic low level ($\leq 0.2 \times V_{DDCA}$), all other inputs shall be between V_{ILmin} and V_{IHmax} . The LPDDR2 device will only guarantee that outputs are in a high impedance state while CKE is held low.

On or before the completion of the power ramp (T_b) CKE must be held low.

DQ, DM, DQS_t and DQS_c voltage levels must be between V_{SSQ} and V_{DDQ} during voltage ramp to avoid latchup. CK_t, CK_c, CS_n, and CA input levels must be between V_{SSCA} and V_{DDCA} during voltage ramp to avoid latch-up.

The following conditions apply:

T_a is the point where any power supply first reaches 300mV.

After T_a is reached, V_{DD1} must be greater than $V_{DD2} - 200mV$.

After T_a is reached, V_{DD1} and V_{DD2} must be greater than $V_{DDCA} - 200mV$.

After T_a is reached, V_{DD1} and V_{DD2} must be greater than $V_{DDQ} - 200mV$.

After T_a is reached, V_{REF} must always be less than all other supply voltages.

The voltage difference between any of V_{SS} , V_{SSQ} , and V_{SSCA} pins may not exceed 100mV.

The above conditions apply between T_a and power-off (controlled or uncontrolled).

T_b is the point when all supply voltages are within their respective min/max operating conditions. Reference voltages shall be within their respective min/max operating conditions a minimum of 5 clocks before CKE goes high.

For supply and reference voltage operating conditions, see 8.2.1.1 "Recommended DC Operating Conditions" table.

Power ramp duration t_{INIT0} ($T_b - T_a$) must be no greater than 20 mS.

2. CKE and clock

Beginning at T_b , CKE must remain low for at least $t_{INIT1} = 100$ nS, after which it may be asserted high. Clock must be stable at least $t_{INIT2} = 5 \times t_{CK}$ prior to the first low to high transition of CKE (T_c). CKE, CS_n and CA inputs must observe setup and hold time (t_{IS} , t_{IH}) requirements with respect to the first rising clock edge (as well as to the subsequent falling and rising edges).

The clock period shall be within the range defined for t_{CKb} (18 nS to 100 nS), if any Mode Register Reads are performed. Mode Register Writes can be sent at normal clock operating frequencies so long as all AC Timings are met. Furthermore, some AC parameters (e.g. t_{DQSCK}) may have relaxed timings (e.g. t_{DQSCKb}) before the system is appropriately configured.

While keeping CKE high, issue NOP commands for at least $t_{INIT3} = 200$ μ S. (T_d).



3. Reset command

After t_{INIT3} is satisfied, a MRW(Reset) command shall be issued (T_d). The memory controller may optionally issue a Precharge-All command prior to the MRW Reset command. Wait for at least $t_{INIT4} = 1 \mu\text{S}$ while keeping CKE asserted and issuing NOP commands.

4. Mode Registers Reads and Device Auto-Initialization (DAI) polling:

After t_{INIT4} is satisfied (T_e) only MRR commands and power-down entry/exit commands are allowed. Therefore, after T_e , CKE may go low in accordance to Power-Down entry and exit specification (see section 7.4.25 "Power-Down").

The MRR command may be used to poll the DAI-bit to acknowledge when Device Auto-Initialization is complete or the memory controller shall wait a minimum of t_{INIT5} before proceeding.

As the memory output buffers are not properly configured yet, some AC parameters may have relaxed timings before the system is appropriately configured.

After the DAI-bit (MR#0, "DAI") is set to zero "DAI complete" by the memory device, the device is in idle state (T_f). The state of the DAI status bit can be determined by an MRR command to MR#0.

The LPDDR2 SDRAM device will set the DAI-bit no later than t_{INIT5} (10 μS) after the Reset command. The memory controller shall wait a minimum of t_{INIT5} or until the DAI-bit is set before proceeding.

After the DAI-Bit is set, it is recommended to determine the device type and other device characteristics by issuing MRR commands (MR0 "Device Information" etc.).

5. ZQ Calibration:

After t_{INIT5} (T_f), an MRW ZQ Initialization Calibration command may be issued to the memory (MR10). This command is used to calibrate the LPDDR2 output drivers (RON) over process, voltage, and temperature. Optionally, the MRW ZQ Initialization Calibration command will update MR0 to indicate RZQ pin connection. In systems in which more than one LPDDR2 device exists on the same bus, the controller must not overlap ZQ Calibration commands. The device is ready for normal operation after t_{ZQINIT} .

6. Normal Operation:

After t_{ZQINIT} (T_g), MRW commands may be used to properly configure the memory, for example the output buffer driver strength, latencies etc. Specifically, MR1, MR2, and MR3 shall be set to configure the memory for the target frequency and memory configuration.

The LPDDR2 device will now be in IDLE state and ready for any valid command.

After T_g , the clock frequency may be changed according to the clock frequency change procedure described in section 7.4.27 "Input Clock Stop and Frequency Change".



7.2.2 Timing Parameters for Initialization

Symbol	Value		Unit	Comment
	min	max		
tINIT0		20	mS	Maximum Power Ramp Time
tINIT1	100		nS	Minimum CKE low time after completion of power ramp
tINIT2	5		tCK	Minimum stable clock before first CKE high
tINIT3	200		μS	Minimum Idle time after first CKE assertion
tINIT4	1		μS	Minimum Idle time after Reset command
tINIT5		10	μS	Maximum duration of Device Auto-Initialization
tzQINIT	1		μS	ZQ Initial Calibration for LPDDR2-S4
tCKb	18	100	nS	Clock cycle time during boot

7.2.3 Power Ramp and Initialization Sequence

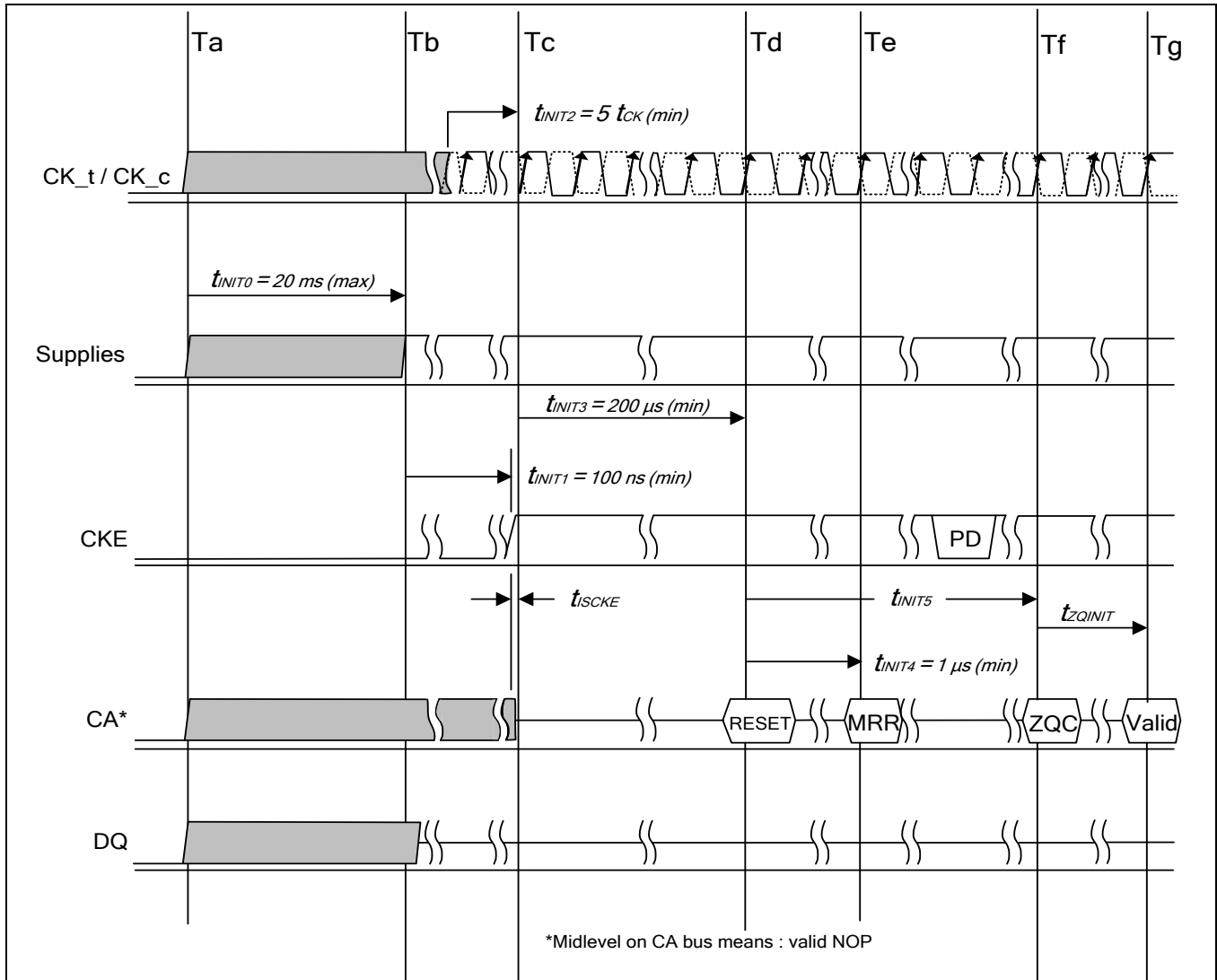



7.2.4 Initialization after Reset (without Power ramp)

If the RESET command is issued outside the power up initialization sequence, the reinitialization procedure shall begin with step 3 (Td).

7.2.5 Power-off Sequence

The following sequence shall be used to power off the LPDDR2 device.

While removing power, CKE shall be held at a logic low level ($\leq 0.2 \times VDDCA$), all other inputs shall be between VIL_{min} and VIH_{max} . The LPDDR2 device will only guarantee that outputs are in a high impedance state while CKE is held low.

DQ, DM, DQS_t and DQS_c voltage levels must be between $VSSQ$ and $VDDQ$ during power off sequence to avoid latch-up. CK_t, CK_c, CS_n and CA input levels must be between $VSSCA$ and $VDDCA$ during power off sequence to avoid latch-up.

Tx is the point where any power supply decreases under its minimum value specified in 8.2.1.1 “Recommended DC Operating Conditions” table.

Tz is the point where all power supplies are below 300 mV. After Tz, the device is powered off.

The time between Tx and Tz (tPOFF) shall be less than 2s.

The following conditions apply:

Between Tx and Tz, $VDD1$ must be greater than $VDD2 - 200$ mV.

Between Tx and Tz, $VDD1$ and $VDD2$ must be greater than $VDDCA - 200$ mV.

Between Tx and Tz, $VDD1$ and $VDD2$ must be greater than $VDDQ - 200$ mV.

Between Tx and Tz, $VREF$ must always be less than all other supply voltages.

The voltage difference between any of VSS , $VSSQ$, and $VSSCA$ pins may not exceed 100 mV.

For supply and reference voltage operating conditions, see 8.2.1.1 “Recommended DC Operating Conditions” table.

7.2.6 Timing Parameters Power-Off

Symbol	Value		Unit	Comment
	min	max		
tPOFF	-	2	s	Maximum Power-Off Ramp Time

7.2.7 Uncontrolled Power-Off Sequence

The following sequence shall be used to power off the LPDDR2 device under uncontrolled condition.

Tx is the point where any power supply decreases under its minimum value specified in the DC operating condition table. After turning off all power supplies, any power supply current capacity must be zero, except for any static charge remaining in the system.

Tz is the point where all power supply first reaches 300 mV. After Tz, the device is powered off.

The time between Tx and Tz (tPOFF) shall be less than 2s. The relative levels between supply voltages are uncontrolled during this period.

$VDD1$ and $VDD2$ shall decrease with a slope lower than 0.5 V/ μ S between Tx and Tz.

Uncontrolled power off sequence can be applied only up to 400 times in the life of the device.



7.3 Mode Register Definition

7.3.1 Mode Register Assignment and Definition

Each register is denoted as “R” if it can be read but not written, “W” if it can be written but not read, and “R/W” if it can be read and written.

Mode Register Read command shall be used to read a register. Mode Register Write command shall be used to write a register.

7.3.1.1 Mode Register Assignment

MR#	MA[7:0]	Function	Access	OP7	OP6	OP5	OP4	OP3	OP2	OP1	OP0
0	00H	Device Info.	R	(RFU)			RZQI		DNVI	DI	DAI
1	01H	Device Feature 1	W	nWR (for AP)			WC	BT	BL		
2	02H	Device Feature 2	W	(RFU)			RL & WL				
3	03H	I/O Config-1	W	(RFU)			DS				
4	04H	Refresh Rate	R	TUF	(RFU)			Refresh Rate			
5	05H	Basic Config-1	R	LPDDR2 Manufacturer ID							
6	06H	Basic Config-2	R	Revision ID1							
7	07H	Basic Config-3	R	Revision ID2							
8	08H	Basic Config-4	R	I/O width		Density			Type		
9	09H	Test Mode	W	Vendor-Specific Test Mode							
10	0AH	I/O Calibration	W	Calibration Code							
11-15	0BH~0FH	(reserved)	-	(RFU)							
16	10H	PASR_Bank	W	Bank Mask							
17	11H	PASR_Seg	W	Segment Mask							
18-19	12H~13H	(Reserved)	-	(RFU)							
20-31	14h - 1Fh	Reserved for NVM									
32	20H	DQ Calibration Pattern A	R	See 7.4.21.2 “DQ Calibration”							
33-39	21H~27H	(Do Not Use)	-								
40	28H	DQ Calibration Pattern B	R	See 7.4.21.2 “DQ Calibration”							
41-47	29H~2FH	(Do Not Use)	-								
48-62	30H~3EH	(Reserved)	-	(RFU)							
63	3FH	Reset	W	X							
64-126	40H~7EH	(Reserved)	-	(RFU)							
127	7FH	(Do Not Use)	-								
128-190	80H~BEH	(Reserved for Vendor Use)	-	(RFU)							
191	BFH	(Do Not Use)	-								
192-254	C0H~FEH	(Reserved for Vendor Use)	-	(RFU)							
255	FFH	(Do Not Use)	-								

Notes:

1. RFU bits shall be set to '0' during Mode Register writes.
2. RFU bits shall be read as '0' during Mode Register reads.
3. All Mode Registers that are specified as RFU or write-only shall return undefined data when read and DQS shall be toggled.
4. All Mode Registers that are specified as RFU shall not be written.
5. Writes to read-only registers shall have no impact on the functionality of the device.



7.3.2 MR0_Device Information (MA[7:0] = 00H)

OP7	OP6	OP5	OP4	OP3	OP2	OP1	OP0
(RFU)			RZQI		DNVI	DI	DAI

DAI (Device Auto-Initialization Status)	Read-only	OP0	0b : DAI complete 1b : DAI still in progress
DI (Device Information)	Read-only	OP1	0b : S4 SDRAM
DNVI (Data Not Valid Information)	Read-only	OP2	0b : LPDDR2 SDRAM will not implement DNV functionality
RZQI (Built in Self Test for RZQ Information)	Read-only	OP[4:3]	00b : RZQ self test not executed. 01b : ZQ-pin may connect to VDDCA or float 10b : ZQ-pin may short to GND 11b : ZQ-pin self test completed, no error condition detected (ZQ-pin may not connect to VDDCA or float nor short to GND)

Notes:

- RZQI will be set upon completion of the MRW ZQ Initialization Calibration command.
- If ZQ is connected to VDDCA to set default calibration by user, OP[4:3] shall be read as 01. If user does not want to connect ZQ pin to VDDCA, but OP[4:3] is read as 01 or 10, it might indicate a ZQ-pin assembly error. It is recommended that the assembly error being corrected first.
- In the case of possible assembly error (either OP[4:3]=01 or OP[4:3]=10 as defined above), the LPDDR2 device will default to factory trim settings for RON, and will ignore ZQ calibration commands. In either case, the system may not function as intended.
- In the case of the ZQ self-test returning a value of 11b, this result indicates that the device has detected a resistor connection to the ZQ pin. However, this result cannot be used to validate the ZQ resistor value or that the ZQ resistor tolerance meets the specified limits (i.e., 240 Ohm \pm 1%).

7.3.3 MR1_Device Feature 1 (MA[7:0] = 01H)

OP7	OP6	OP5	OP4	OP3	OP2	OP1	OP0
nWR (for AP)			WC	BT	BL		

BL	Write-only	OP[2:0]	010b : BL4 (default) 011b : BL8 100b : BL16 All others : reserved
BT	Write-only	OP3	0b : Sequential (default) 1b : Interleaved
WC	Write-only	OP4	0b : Wrap (default) 1 b : No wrap (allowed for SDRAM BL4 only)
nWR	Write-only	OP[7:5]	001b : nWR=3 (default) 010b : nWR=4 011b : nWR=5 100b : nWR=6 101b : nWR=7 110b : nWR=8 All others : reserved

Note:

- Programmed value in nWR register is the number of clock cycles which determines when to start internal precharge operation for a write burst with AP enabled. It is determined by $RU(tWR/tCK)$.



7.3.3.1 Burst Sequence by Burst Length (BL), Burst Type (BT), and Warp Control (WC)

C3	C2	C1	C0	WC	BT	BL	Burst Cycle Number and Burst Address Sequence																						
							1	2	3	4	5	6	7	8	9	10	11	12	13	14	15	16							
X	X	0b	0b	wrap	any	4	0	1	2	3																			
X	X	1b	0b				2	3	0	1																			
X	X	X	0b				nw	any	y	y+1	y+2	y+3																	
X	0b	0b	0b	wrap	seq	8	0	1	2	3	4	5	6	7															
X	0b	1b	0b				2	3	4	5	6	7	0	1															
X	1b	0b	0b				4	5	6	7	0	1	2	3															
X	1b	1b	0b				6	7	0	1	2	3	4	5															
X	0b	0b	0b				0	1	2	3	4	5	6	7															
X	0b	1b	0b				2	3	0	1	6	7	4	5															
X	1b	0b	0b				4	5	6	7	0	1	2	3															
X	1b	1b	0b				6	7	4	5	2	3	0	1															
X	X	X	0b		nw	any	illegal (not allowed)																						
0b	0b	0b	0b		wrap	seq	16	0	1	2	3	4	5	6	7	8	9	A	B	C	D	E	F						
0b	0b	1b	0b					2	3	4	5	6	7	8	9	A	B	C	D	E	F	0	1						
0b	1b	0b	0b					4	5	6	7	8	9	A	B	C	D	E	F	0	1	2	3						
0b	1b	1b	0b					6	7	8	9	A	B	C	D	E	F	0	1	2	3	4	5						
1b	0b	0b	0b					8	9	A	B	C	D	E	F	0	1	2	3	4	5	6	7						
1b	0b	1b	0b	A				B	C	D	E	F	0	1	2	3	4	5	6	7	8	9							
1b	1b	0b	0b	C				D	E	F	0	1	2	3	4	5	6	7	8	9	A	B							
1b	1b	1b	0b	E				F	0	1	2	3	4	5	6	7	8	9	A	B	C	D							
X	X	X	0b	nw		int	illegal (not allowed)																						
X	X	X	0b	nw		any	illegal (not allowed)																						

Notes:

- C0 input is not present on CA bus. It is implied zero.
- For BL=4, the burst address represents C[1: 0].
- For BL=8, the burst address represents C[2:0].
- For BL=16, the burst address represents C[3:0].
- For no-wrap (nw), BL4, the burst shall not cross the page boundary and shall not cross sub-page boundary. The variable y may start at any address with C0 equal to 0 and may not start at any address shown in table below.

7.3.3.2 Non Wrap Restrictions

Bus Width	2Gb
Not across full page boundary	
x16	3FE, 3FF, 000, 001
x32	1FE, 1FF, 000, 001
Not across sub page boundary	
x16	1FE, 1FF, 200, 201
x32	None

Note: Non-wrap BL=4 data-orders shown above are prohibited.



7.3.4 MR2_Device Feature 2 (MA[7:0] = 02H)

OP7	OP6	OP5	OP4	OP3	OP2	OP1	OP0
(RFU)				RL & WL			
RL & WL	Write-only		OP[3:0]	0001b: RL = 3 / WL = 1 (default) 0010b: RL = 4 / WL = 2 0011b: RL = 5 / WL = 2 0100b: RL = 6 / WL = 3 0101b: RL = 7 / WL = 4 0110b: RL = 8 / WL = 4 All others: reserved			

7.3.5 MR3_I/O Configuration 1 (MA[7:0] = 03H)

OP7	OP6	OP5	OP4	OP3	OP2	OP1	OP0
(RFU)				DS			
DS	Write-only		OP[3:0]	0000b: reserved 0001b: 34.3-ohm typical 0010b: 40-ohm typical (default) 0011b: 48-ohm typical 0100b: 60-ohm typical 0101b: reserved for 68.6-ohm typical 0110b: 80-ohm typical 0111b: 120-ohm typical All others: reserved			

7.3.6 MR4_Device Temperature (MA[7:0] = 04H)

OP7	OP6	OP5	OP4	OP3	OP2	OP1	OP0
TUF	(RFU)				SDRAM Refresh Rate		
SDRAM Refresh Rate	Read-only	OP[2:0]	000b: SDRAM Low temperature operating limit exceeded 001b: 4x tREFI, 4x tREFIpb, 4x tREFW 010b: 2x tREFI, 2x tREFIpb, 2x tREFW 011b: 1x tREFI, 1x tREFIpb, 1x tREFW ($\leq 85^{\circ}\text{C}$) 100b: Reserved 101b: 0.25x tREFI, 0.25x tREFIpb, 0.25x tREFW, do not de-rate SDRAM AC timing 110b: 0.25x tREFI, 0.25x tREFIpb, 0.25x tREFW, de-rate SDRAM AC timing 111b: SDRAM High temperature operating limit exceeded				
Temperature Update Flag (TUF)	Read-only	OP7	0b: OP[2:0] value has not changed since last read of MR4. 1b: OP[2:0] value has changed since last read of MR4.				

Notes:

1. A Mode Register Read from MR4 will reset OP7 to '0'.
2. OP7 is reset to '0' at power-up.
3. If OP2 equals '1', the device temperature is greater than 85°C.
4. OP7 is set to '1' if OP2:OP0 has changed at any time since the last read of MR4.
5. LPDDR2 might not operate properly when OP[2:0] = 000b or 111b.
6. For specified operating temperature range and maximum operating temperature, refer to "Operating Temperature Conditions" table.
7. LPDDR2 devices must be derated by adding 1.875 nS to the following core timing parameters: tRCD, tRC, tRAS, tRP, and tRRD. tDQSCK shall be de-rated according to the tDQSCK de-rating value in "LPDDR2 AC Timing" table. Prevailing clock frequency spec and related setup and hold timings shall remain unchanged.
8. The recommended frequency for reading MR4 is provided in "Temperature Sensor" section.



7.3.7 MR5_Basic Configuration 1 (MA[7:0] = 05H)

OP7	OP6	OP5	OP4	OP3	OP2	OP1	OP0
LPDDR2 Manufacturer ID							

LPDDR2 Manufacturer ID	Read-only	OP[7:0]	0000 1000b: Winbond
------------------------	-----------	---------	---------------------

7.3.8 MR6_Basic Configuration 2 (MA[7:0] = 06H)

OP7	OP6	OP5	OP4	OP3	OP2	OP1	OP0
Revision ID1							

Revision ID1	Read-only	OP[7:0]	00000000b: A-version
--------------	-----------	---------	----------------------

Note: MR6 is Vendor Specific.

7.3.9 MR7_Basic Configuration 3 (MA[7:0] = 07H)

OP7	OP6	OP5	OP4	OP3	OP2	OP1	OP0
Revision ID2							

Revision ID2	Read-only	OP[7:0]	00000000b: A-version
--------------	-----------	---------	----------------------

Note: MR7 is Vendor Specific.

7.3.10 MR8_Basic Configuration 4 (MA[7:0] = 08H)

OP7	OP6	OP5	OP4	OP3	OP2	OP1	OP0
I/O width		Density			Type		

Type	Read-only	OP[1:0]	00b: S4 SDRAM
Density	Read-only	OP[5:2]	0101b: 2Gb
I/O width	Read-only	OP[7:6]	00b: x32 01b: x16

7.3.11 MR9_Test Mode (MA[7:0] = 09H)

OP7	OP6	OP5	OP4	OP3	OP2	OP1	OP0
Vendor-specific Test Mode							



7.3.12 MR10_Calibration (MA[7:0] = 0AH)

OP7	OP6	OP5	OP4	OP3	OP2	OP1	OP0
Calibration Code							

Calibration Code	Write-only	OP[7:0]	0xFF: Calibration command after initialization 0xAB: Long calibration 0x56: Short calibration 0xC3: ZQ Reset others: Reserved
------------------	------------	---------	--

Notes:

- Host processor shall not write MR10 with "Reserved" values.
- LPDDR2 devices shall ignore calibration command when a "Reserved" value is written into MR10.
- See AC timing table for the calibration latency.
- If ZQ is connected to VSSCA through RZQ, either the ZQ calibration function (see section 7.4.24 "Mode Register Write ZQ Calibration Command") or default calibration (through the ZQreset command) is supported. If ZQ is connected to VDDCA, the device operates with default calibration, and ZQ calibration commands are ignored. In both cases, the ZQ connection shall not change after power is applied to the device.
- Optionally, the MRW ZQ Initialization Calibration command will update MR0 to indicate RZQ pin connection.

7.3.13 MR16_PASR_Bank Mask (MA[7:0] = 10H)

	OP7	OP6	OP5	OP4	OP3	OP2	OP1	OP0
S4 SDRAM	Bank Mask (8-bank)							

Bank [7:0] Mask	Write-only	OP[7:0]	0b: refresh enable to the bank (=unmasked, default) 1b: refresh blocked (=masked)
-----------------	------------	---------	--

OP	Bank Mask	8-Bank S4 SDRAM
0	XXXXXXX1	Bank 0
1	XXXXXX1X	Bank 1
2	XXXXX1XX	Bank 2
3	XXXX1XXX	Bank 3
4	XXX1XXXX	Bank 4
5	XX1XXXXX	Bank 5
6	X1XXXXXX	Bank 6
7	1XXXXXXX	Bank 7



7.3.14 MR17_PASR_Segment Mask (MA[7:0] = 11H)

OP7	OP6	OP5	OP4	OP3	OP2	OP1	OP0
Segment Mask							

Segment [7:0] Mask	Write-only	OP[7:0]	0b : refresh enable to the segment (=unmasked, default) 1b : refresh blocked (=masked)
--------------------	------------	---------	---

Segment	OP	Segment Mask	R[13:11]
0	0	XXXXXXXX1	000b
1	1	XXXXXXXX1X	001b
2	2	XXXXX1XX	010b
3	3	XXXX1XXX	011b
4	4	XXX1XXXX	100b
5	5	XX1XXXXX	101b
6	6	X1XXXXXX	110b
7	7	1XXXXXXX	111b

7.3.15 MR32_DQ Calibration Pattern A (MA[7:0] = 20H)

Reads to MR32 return DQ Calibration Pattern "A". See section 7.4.21.2 "DQ Calibration".

7.3.16 MR40_DQ Calibration Pattern B (MA[7:0] = 28H)

Reads to MR40 return DQ Calibration Pattern "B". See section 7.4.21.2 "DQ Calibration".

7.3.17 MR63_Reset (MA[7:0] = 3FH): MRW only

OP7	OP6	OP5	OP4	OP3	OP2	OP1	OP0
X							

For additional information on MRW RESET see section 7.4.22 "Mode Register Write Command".



7.4 Command Definitions and Timing Diagrams

7.4.1 Activate Command

The SDRAM Activate command is issued by holding CS_n LOW, CA0 LOW, and CA1 HIGH at the rising edge of the clock. The bank addresses are used to select the desired bank. The row addresses are used to determine which row to activate in the selected bank. The Activate command must be applied before any Read or Write operation can be executed. The LPDDR2 SDRAM can accept a read or write command at time t_{RCD} after the activate command is sent. Once a bank has been activated it must be precharged before another Activate command can be applied to the same bank. The bank active and precharge times are defined as t_{RAS} and t_{RP}, respectively. The minimum time interval between successive Activate commands to the same bank is determined by the RAS cycle time of the device (t_{RC}). The minimum time interval between Activate commands to different banks is t_{RRD}.

Certain restrictions on operation of the 8-bank devices must be observed. There are two rules. One for restricting the number of sequential Activate commands that can be issued and another for allowing more time for RAS precharge for a Precharge All command. The rules are as follows:

8-bank device Sequential Bank Activation Restriction: No more than 4 banks may be activated (or refreshed, in the case of REFpb) in a rolling t_{FAW} window. Converting to clocks is done by dividing t_{FAW}[nS] by t_{CK}[nS], and rounding up to next integer value. As an example of the rolling window, if RU{ (t_{FAW} / t_{CK}) } is 10 clocks, and an activate command is issued in clock N, no more than three further activate commands may be issued at or between clock N+1 and N+9. REFpb also counts as bank-activation for the purposes of t_{FAW}.

8-bank device Precharge All Allowance: t_{RP} for a Precharge All command for an 8-bank device shall equal t_{RPab}, which is greater than t_{RPpb}.

7.4.1.1 Activate Command Cycle: t_{RCD} = 3, t_{RP} = 3, t_{RRD} = 2

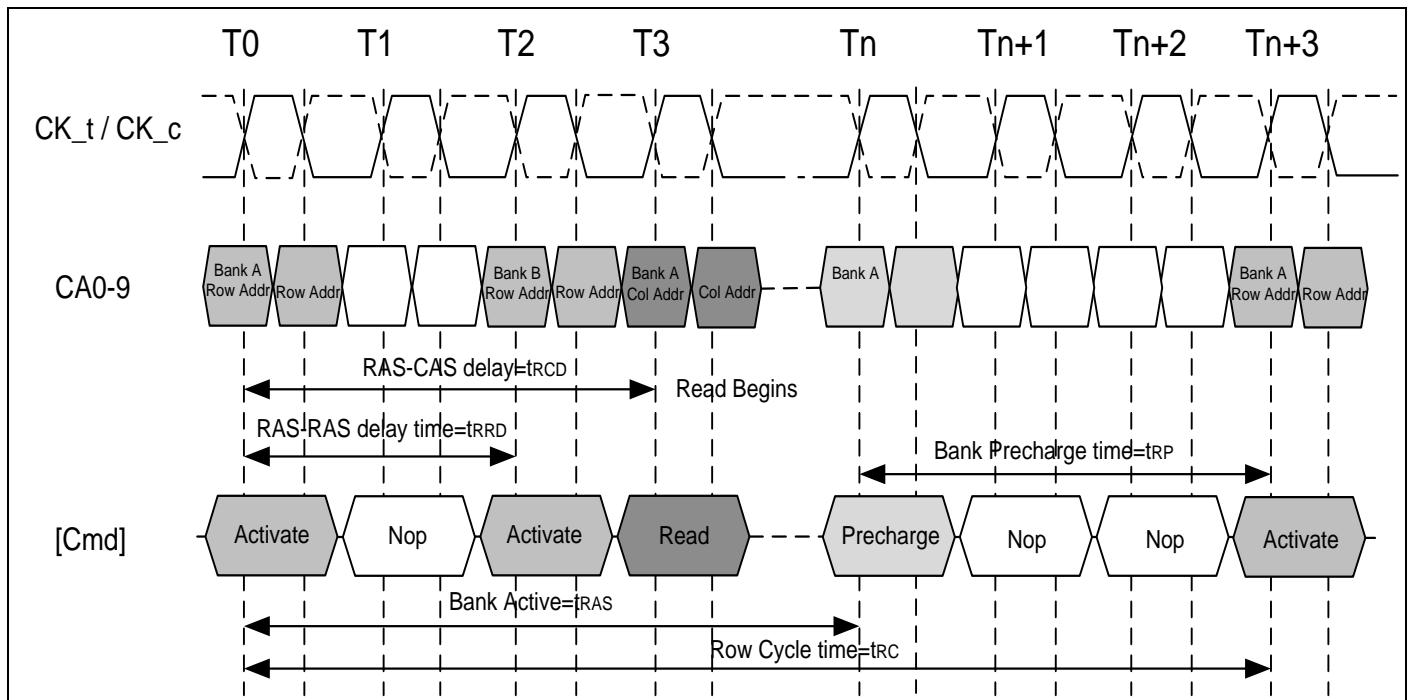

Note:

A Precharge-All command uses t_{RPab} timing, while a Single Bank Precharge command uses t_{RPpb} timing. In this figure, t_{RP} is used to denote either an All-bank Precharge or a Single Bank Precharge



7.4.1.2 tFAW Timing

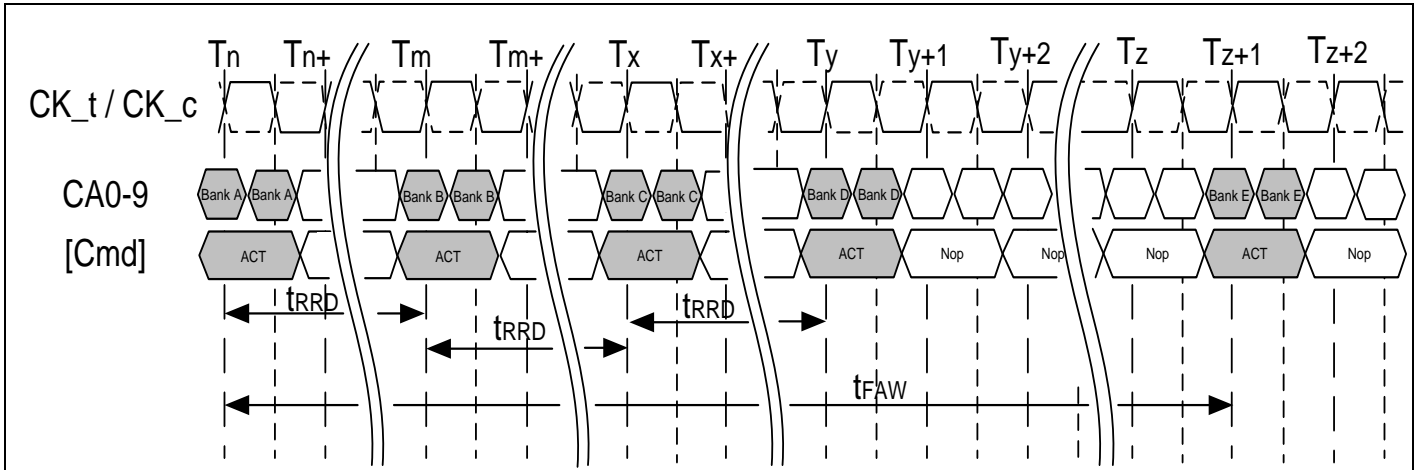

Note: tFAW is for 8-bank devices only.

7.4.1.3 Command Input Setup and Hold Timing

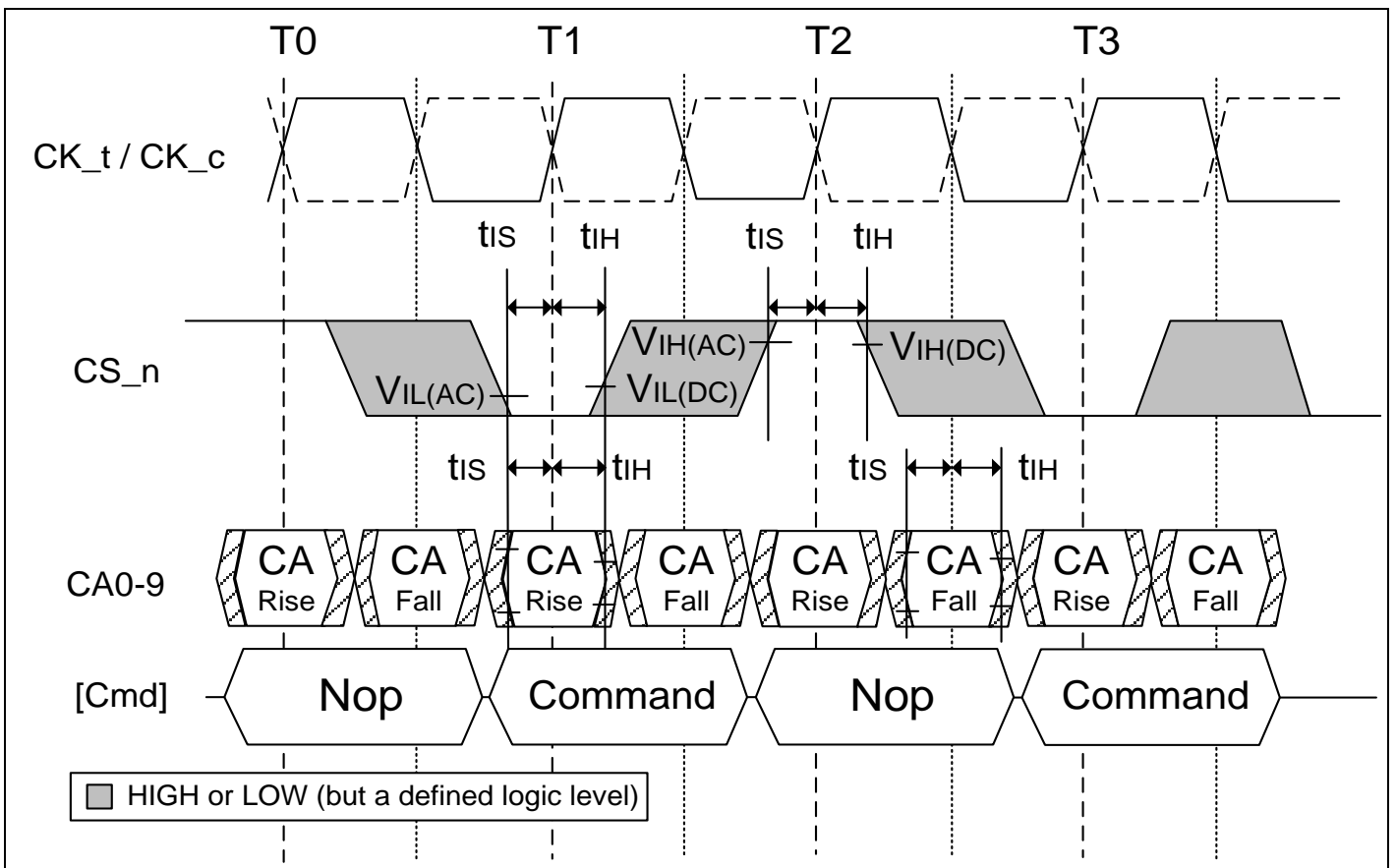

Note: Setup and hold conditions also apply to the CKE pin. See section related to power down for timing diagrams related to the CKE pin.



7.4.1.4 CKE Input Setup and Hold Timing

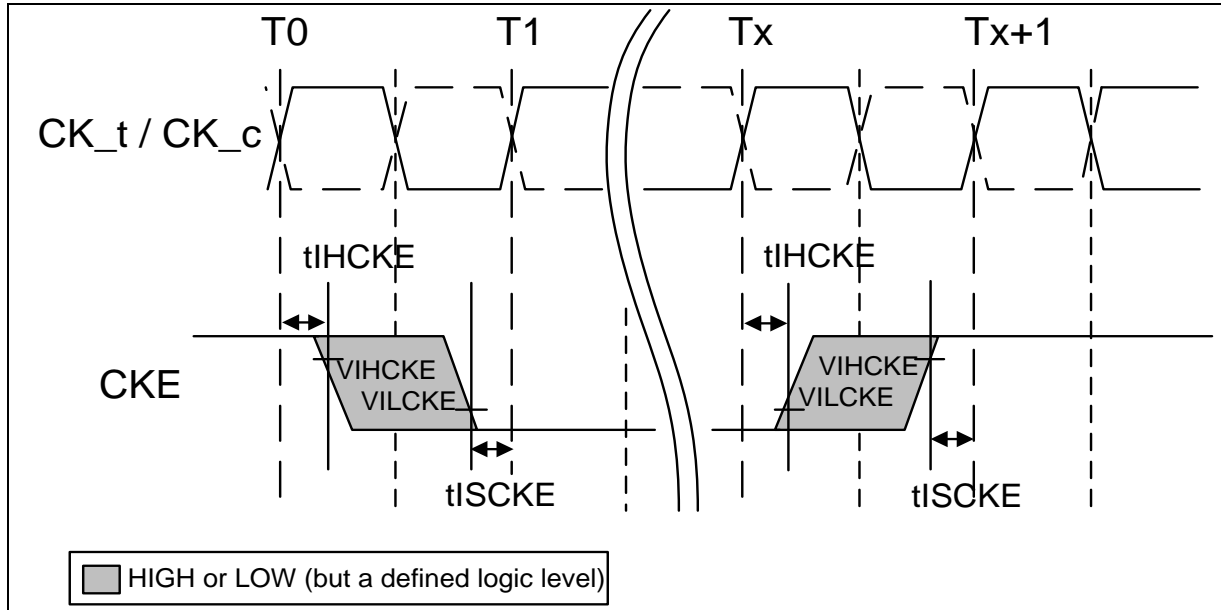

Notes:

1. After CKE is registered LOW, CKE signal level shall be maintained below VILCKE for tCKE specification (LOW pulse width).
2. After CKE is registered HIGH, CKE signal level shall be maintained above VIHCKE for tCKE specification (HIGH pulse width).

7.4.2 Read and Write Access Modes

After a bank has been activated, a read or write cycle can be executed. This is accomplished by setting CS_n LOW, CA0 HIGH, and CA1 LOW at the rising edge of the clock. CA2 must also be defined at this time to determine whether the access cycle is a READ operation (CA2 HIGH) or a WRITE operation (CA2 LOW).

The LPDDR2 SDRAM provides a fast column access operation. A single Read or Write Command will initiate a burst read or write operation on successive clock cycles.

A new burst access must not interrupt the previous 4-bit burst operation in case of BL = 4 setting. In case of BL = 8 and BL = 16 settings, Reads may be interrupted by Reads and Writes may be interrupted by Writes provided that this occurs on even clock cycles after the Read or Write command and tCCD is met.

7.4.3 Burst Read Command

The Burst Read command is initiated by having CS_n LOW, CA0 HIGH, CA1 LOW and CA2 HIGH at the rising edge of the clock. The command address bus inputs, CA5r-CA6r and CA1f-CA9f, determine the starting column address for the burst. The Read Latency (RL) is defined from the rising edge of the clock on which the Read Command is issued to the rising edge of the clock from which the tDQSCK delay is measured. The first valid datum is available RL * tCK + tDQSCK + tDQSQ after the rising edge of the clock where the Read Command is issued. The data strobe output is driven LOW tRPRE before the first rising valid strobe edge. The first bit of the burst is synchronized with the first rising edge of the data strobe. Each subsequent data-out appears on each DQ pin edge aligned with the data strobe. The RL is programmed in the mode registers.

Timings for the data strobe are measured relative to the crosspoint of DQS_t and its complement, DQS_c.



7.4.3.1 Data Output (Read) Timing (tDQSCKmax)

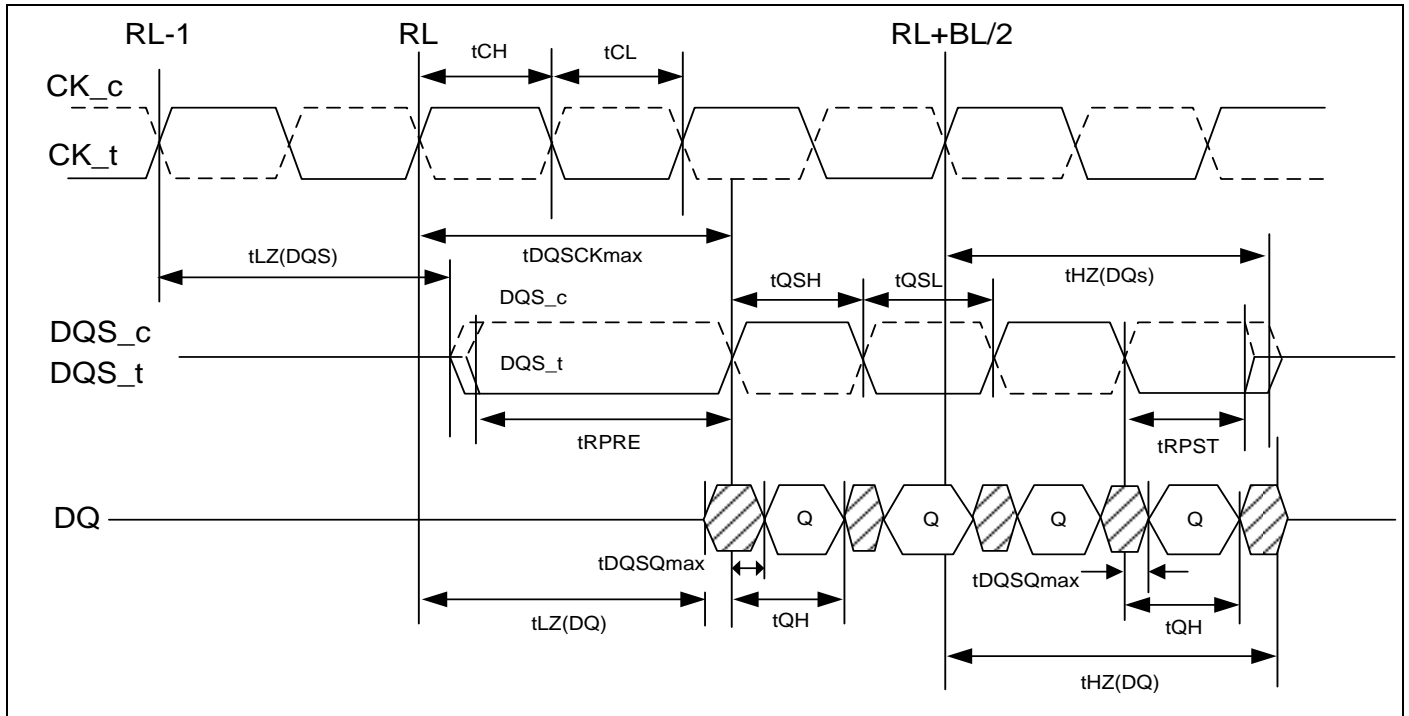

Notes:

1. tDQSCK may span multiple clock periods.
2. An effective Burst Length of 4 is shown.



7.4.3.2 Data Output (Read) Timing (tDQsCKmin)



Note: An effective Burst Length of 4 is shown.

7.4.3.3 Burst Read: RL = 5, BL = 4, tDQsCK > tCK





7.4.3.4 Burst Read: RL = 3, BL = 8, tDQSK < tCK



7.4.3.5 LPDDR2: tDQSKDL Timing



Note: tDQSKDLmax is defined as the maximum of ABS(tDQSKn - tDQSKm) for any {tDQSKn, tDQSKm} pair within any 32mS rolling window.



7.4.3.6 LPDDR2: tDQSCDM Timing



Note: tDQSCDM_{max} is defined as the maximum of ABS(tDQSC_n - tDQSC_m) for any {tDQSC_n, tDQSC_m} pair within any 1.6μs rolling window.

7.4.3.7 LPDDR2: tDQSKDS Timing



Note: tDQSKDS_{max} is defined as the maximum of ABS(tDQSC_n - tDQSC_m) for any {tDQSC_n, tDQSC_m} pair for reads within a consecutive burst within any 160nS rolling window



7.4.3.8 Burst Read Followed by Burst Write: RL = 3, WL = 1, BL = 4



The minimum time from the burst read command to the burst write command is defined by the Read Latency (RL) and the Burst Length (BL). Minimum read to write latency is $RL + RU(tDQSCK_{max}/tCK) + BL/2 + 1 - WL$ clock cycles. Note that if a read burst is truncated with a Burst Terminate (BST) command, the effective burst length of the truncated read burst should be used as “BL” to calculate the minimum read to write delay.

7.4.3.9 Seamless Burst Read: RL = 3, BL = 4, tCCD = 2



The seamless burst read operation is supported by enabling a read command at every other clock for BL = 4 operation, every 4 clocks for BL = 8 operation, and every 8 clocks for BL=16 operation.

For LPDDR2-SDRAM, this operation is allowed regardless of whether the accesses read the same or different banks as long as the banks are activated.



7.4.4 Reads Interrupted by a Read

For LPDDR2-S4 device, burst read can be interrupted by another read on even clock cycles after the Read command, provided that t_{CCD} is met.

7.4.4.1 Read Burst Interrupt Example: $RL = 3$, $BL = 8$, $t_{CCD} = 2$

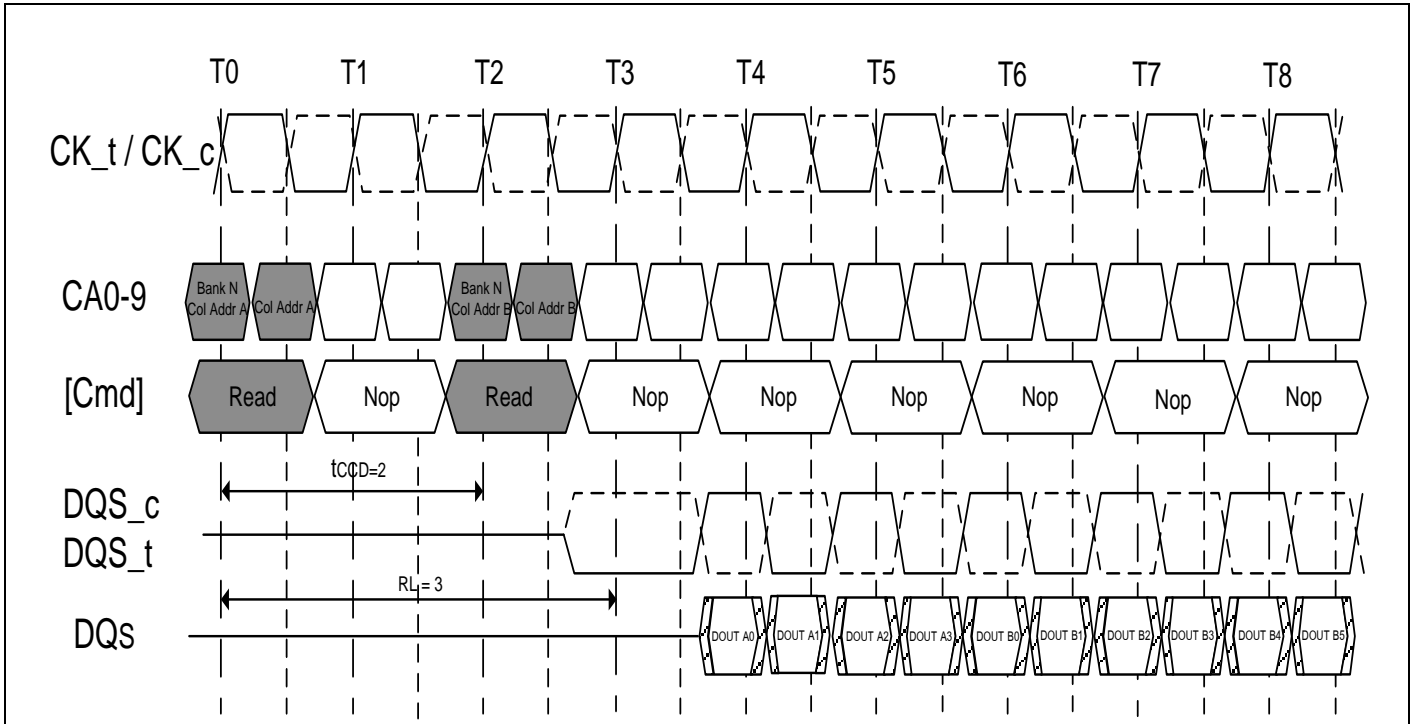

Notes:

1. For LPDDR2-S4 devices, read burst interrupt function is only allowed on burst of 8 and burst of 16.
2. For LPDDR2-S4 devices, read burst interrupt may occur on any clock cycle after the initial read command, provided that t_{CCD} is met.
3. Reads can only be interrupted by other reads or the BST command.
4. Read burst interruption is allowed to any bank inside DRAM.
5. Read burst with Auto-Precharge is not allowed to be interrupted.
6. The effective burst length of the first read equals two times the number of clock cycles between the first read and the interrupting read.

7.4.5 Burst Write Operation

The Burst Write command is initiated by having CS_n LOW, CA0 HIGH, CA1 LOW and CA2 LOW at the rising edge of the clock. The command address bus inputs, CA5r-CA6r and CA1f-CA9f, determine the starting column address for the burst. The Write Latency (WL) is defined from the rising edge of the clock on which the Write Command is issued to the rising edge of the clock from which the tDQS delay is measured. The first valid data must be driven $WL * t_{CK} + t_{DQS}$ from the rising edge of the clock from which the Write command is issued. The data strobe signal (DQS) should be driven LOW t_{WPRE} prior to the data input. The data bits of the burst cycle must be applied to the DQ pins t_{DS} prior to the respective edge of the DQS_t, DQS_c and held valid until t_{DH} after that edge. The burst data are sampled on successive edges of the DQS_t, DQS_c until the burst length is completed, which is 4, 8, or 16 bit burst.

For LPDDR2-SDRAM devices, t_{WR} must be satisfied before a precharge command to the same bank may be issued after a burst write operation.

Input timings are measured relative to the crosspoint of DQS_t and its complement, DQS_c.



7.4.5.1 Data Input (Write) Timing

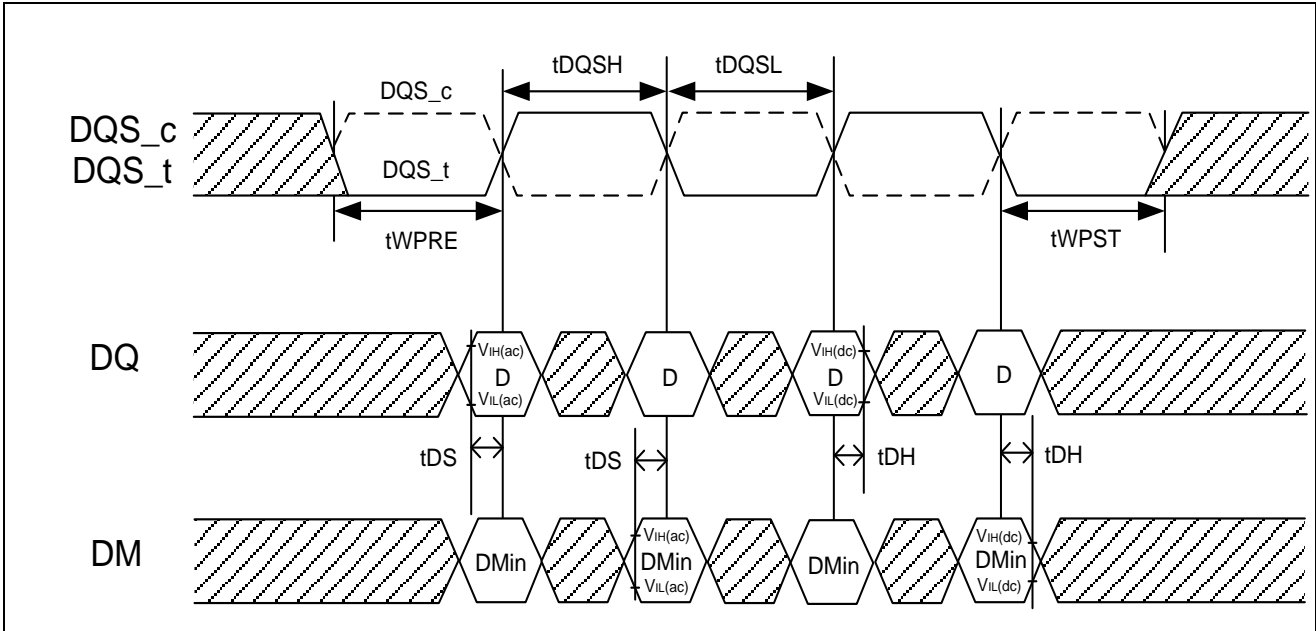

7.4.5.2 Burst Write: WL = 1, BL = 4

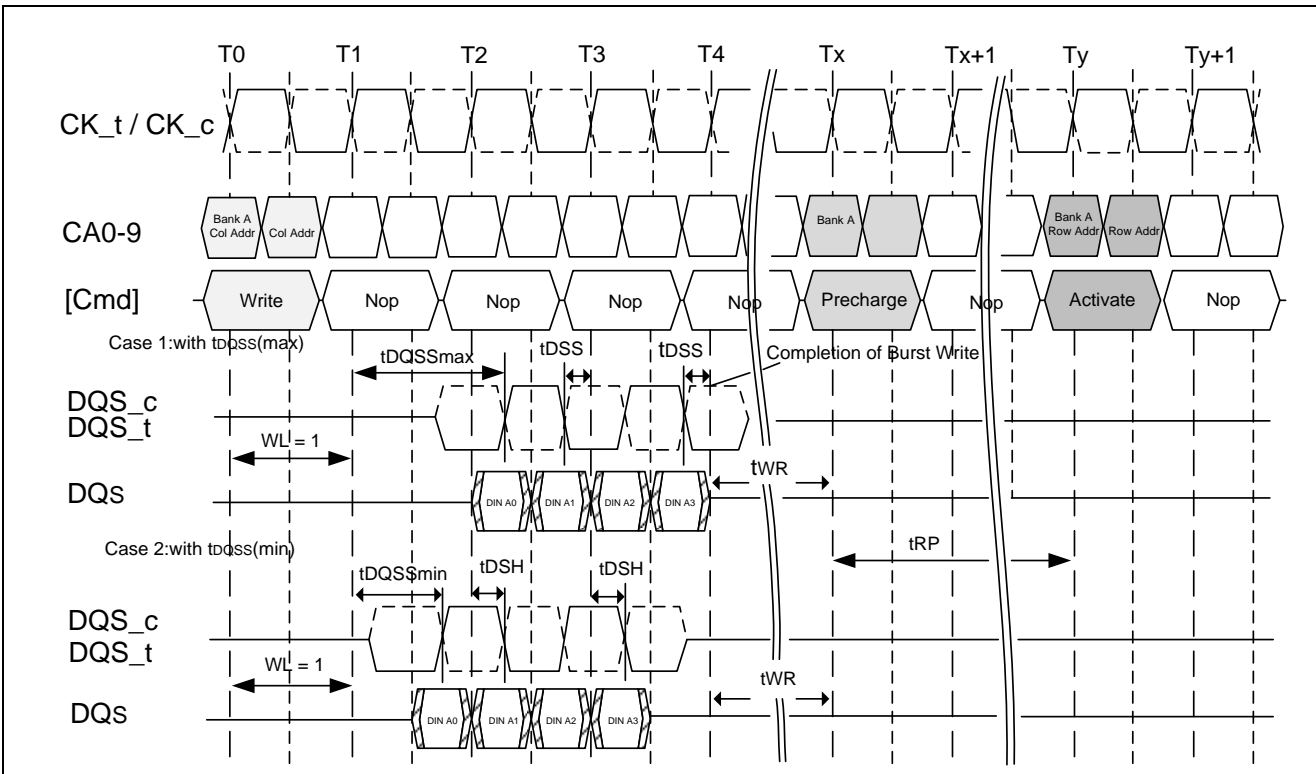



7.4.5.3 Burst Write Followed by Burst Read: RL = 3, WL = 1, BL = 4

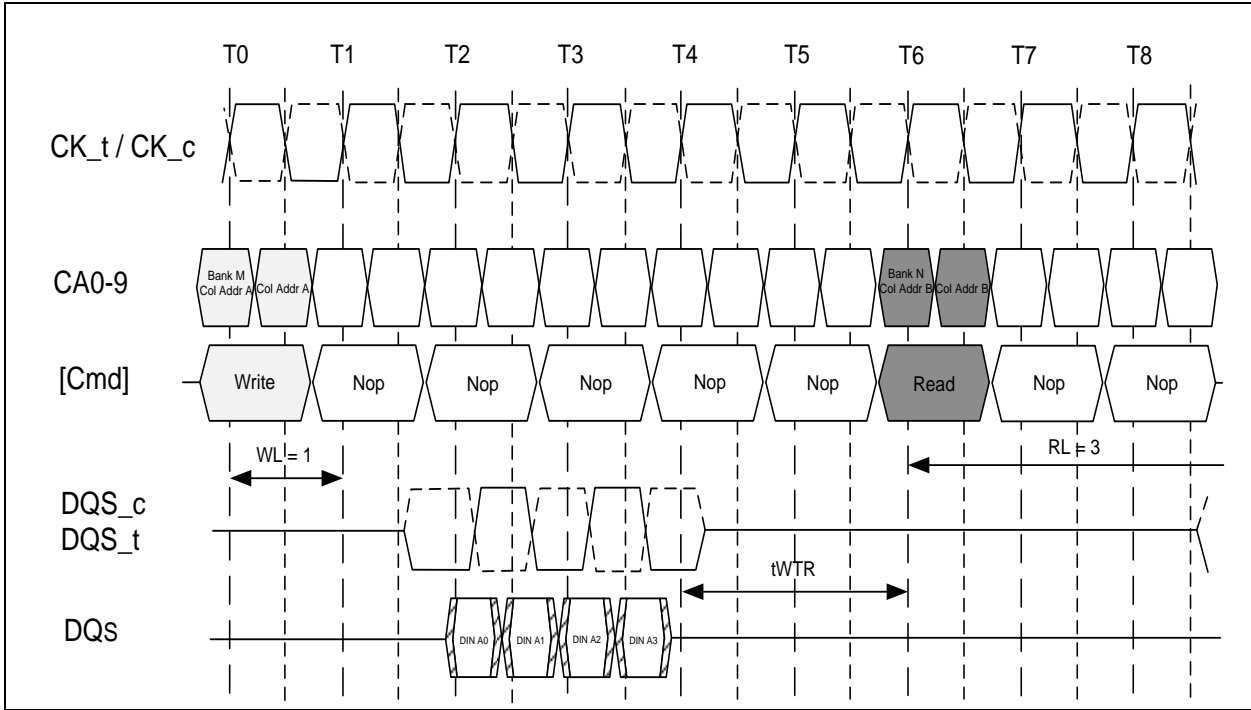

Notes:

1. The minimum number of clock cycles from the burst write command to the burst read command for any bank is $[WL + 1 + BL/2 + RU(tWTR/tCK)]$.
2. $tWTR$ starts at the rising edge of the clock after the last valid input datum.
3. If a write burst is truncated with a Burst Terminate (BST) command, the effective burst length of the truncated write burst should be used as "BL" to calculate the minimum write to read delay.

7.4.5.4 Seamless Burst Write: WL = 1, BL = 4, tCCD = 2

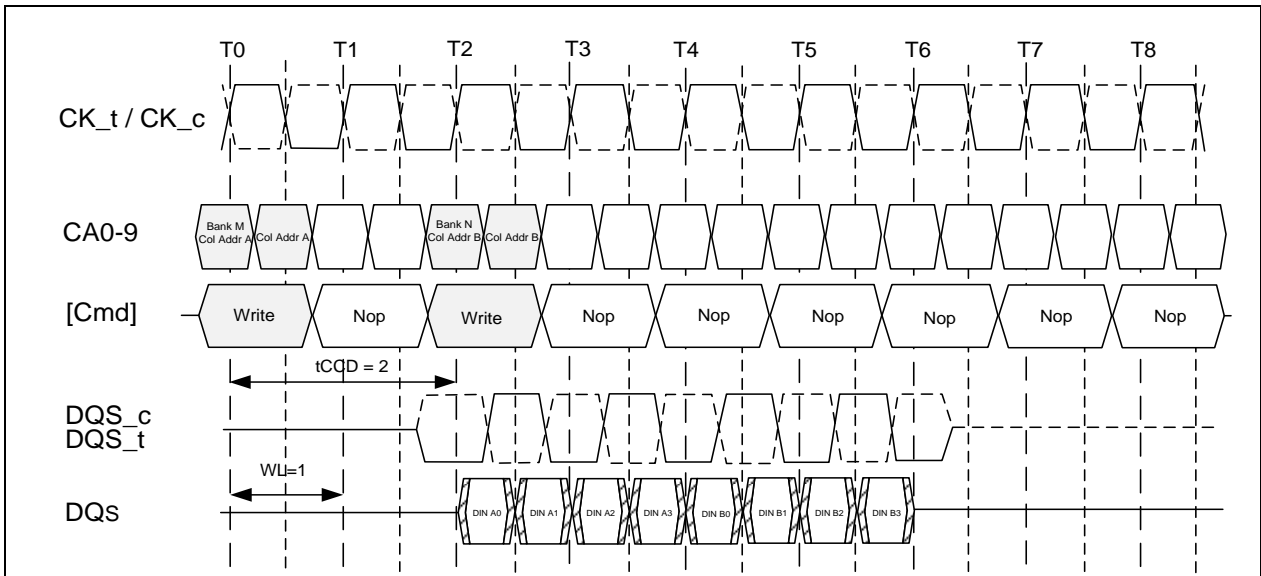

Note:

The seamless burst write operation is supported by enabling a write command every other clock for BL = 4 operation, every four clocks for BL = 8 operation, or every eight clocks for BL = 16 operation. This operation is allowed regardless of same or different banks as long as the banks are activated



7.4.6 Writes Interrupted by a Write

For LPDDR2-S4 devices, burst writes can only be interrupted by another write on even clock cycles after the write command, provided that $t_{CCD}(\min)$ is met.

7.4.6.1 Write Burst Interrupt Timing: $WL = 1$, $BL = 8$, $t_{CCD} = 2$



Notes:

1. For LPDDR2-S4 devices, write burst interrupt function is only allowed on burst of 8 and burst of 16.
2. For LPDDR2-S4 devices, write burst interrupt may only occur on even clock cycles after the previous write commands, provided that $t_{CCD}(\min)$ is met.
3. Writes can only be interrupted by other writes or the BST command.
4. Write burst interruption is allowed to any bank inside DRAM.
5. Write burst with Auto-Precharge is not allowed to be interrupted.
6. The effective burst length of the first write equals two times the number of clock cycles between the first write and the interrupting write.

7.4.7 Burst Terminate

The Burst Terminate (BST) command is initiated by having CS_n LOW, CA0 HIGH, CA1 HIGH, CA2 LOW, and CA3 LOW at the rising edge of clock. A Burst Terminate command may only be issued to terminate an active Read or Write burst. Therefore, a Burst Terminate command may only be issued up to and including $BL/2 - 1$ clock cycles after a Read or Write command. The effective burst length of a Read or Write command truncated by a BST command is as follows:

Effective burst length = $2 \times \{\text{Number of clock cycles from the Read or Write Command to the BST command}\}$

Note that if a read or write burst is truncated with a Burst Terminate (BST) command, the effective burst length of the truncated burst should be used as "BL" to calculate the minimum read to write or write to read delay.

The BST command only affects the most recent read or writes command. The BST command truncates an ongoing read burst $RL \cdot t_{CK} + t_{DQSC} + t_{DQSQ}$ after the rising edge of the clock where the Burst Terminate command is issued. The BST command truncates an on going write burst $WL \cdot t_{CK} + t_{DQSS}$ after the rising edge of the clock where the Burst Terminate command is issued.

For LPDDR2-S4 devices, the 4-bit prefetch architecture allows the BST command to be issued on an even number of clock cycles after a Write or Read command. Therefore, the effective burst length of a Read or Write command truncated by a BST command is an integer multiple of 4.



7.4.7.1 Burst Write Truncated by BST: WL = 1, BL = 16



Notes:

1. The BST command truncates an ongoing write burst $WL * t_{CK} + t_{DQSS}$ after the rising edge of the clock where the Burst Terminate command is issued.
2. For LPDDR2-S4 devices, BST can only be issued at even number of clock cycles after the Write command.
3. Additional BST commands are not allowed after T4 and may not be issued until after the next Read or Write command.

7.4.7.2 Burst Read Truncated by BST: RL = 3, BL = 16



Notes:

1. The BST command truncates an ongoing read burst $RL * t_{CK} + t_{DQSK} + t_{DQSQ}$ after the rising edge of the clock where the Burst Terminate command is issued.
2. For LPDDR2-S4 devices, BST can only be issued at even number of clock cycles after the Read command.
3. Additional BST commands are not allowed after T4 and may not be issued until after the next Read or Write command.



7.4.8 Write Data Mask

One write data mask (DM) pin for each data byte (DQ) will be supported on LPDDR2 devices, consistent with the implementation on LPDDR SDRAMs. Each data mask (DM) may mask its respective data byte (DQ) for any given cycle of the burst. Data mask has identical timings on write operations as the data bits, though used as input only, is internally loaded identically to data bits to insure matched system timing.

See 7.4.14.2 “Precharge & Auto Precharge Clarification” table for Write to Precharge timings.

7.4.8.1 Write Data Mask Timing





7.4.9 Precharge Operation

The Precharge command is used to precharge or close a bank that has been activated. The Precharge command is initiated by having CS_n LOW, CA0 HIGH, CA1 HIGH, CA2 LOW, and CA3 HIGH at the rising edge of the clock. The Precharge Command can be used to precharge each bank independently or all banks simultaneously. For 8-bank devices, the AB flag, and the bank address bits, BA0, BA1, and BA2 are used to determine which bank(s) to precharge. The bank(s) will be available for a subsequent row access tRP_{ab} after an All-Bank Precharge command is issued and tRP_{pb} after a Single-Bank Precharge command is issued.

In order to ensure that 8-bank devices do not exceed the instantaneous current supplying capability of 4-bank devices, the Row Precharge time (tRP) for an All-Bank Precharge for 8-bank devices (tRP_{ab}) will be longer than the Row Precharge time for a Single-Bank Precharge (tRP_{pb}).

7.4.9.1 Bank Selection for Precharge by Address Bits

AB (CA4r)	BA2 (CA9r)	BA1 (CA8r)	BA0 (CA7r)	Precharged Bank(s) 8-bank device
0	0	0	0	Bank 0 only
0	0	0	1	Bank 1 only
0	0	1	0	Bank 2 only
0	0	1	1	Bank 3 only
0	1	0	0	Bank 4 only
0	1	0	1	Bank 5 only
0	1	1	0	Bank 6 only
0	1	1	1	Bank 7 only
1	DON'T CARE	DON'T CARE	DON'T CARE	All Banks

7.4.10 Burst Read Operation Followed by Precharge

For the earliest possible precharge, the precharge command may be issued BL/2 clock cycles after a Read command. For an untruncated burst, BL is the value from the Mode Register. For a truncated burst, BL is the effective burst length. A new bank active (command) may be issued to the same bank after the Row Precharge time (tRP). A precharge command cannot be issued until after tRAS is satisfied.

For LPDDR2-S4 devices, the minimum Read to Precharge spacing has also to satisfy a minimum analog time from the rising clock edge that initiates the last 4-bit prefetch of a Read command. This time is called tRTP (Read to Precharge).

For LPDDR2-S4 devices, tRTP begins BL/2 - 2 clock cycles after the Read command. If the burst is truncated by a BST command or a Read command to a different bank, the effective "BL" shall be used to calculate when tRTP begins.

See 7.4.14.2 "Precharge & Auto Precharge Clarification" table for Read to Precharge timings.



7.4.10.1 Burst Read Followed by Precharge: RL = 3, BL = 8, RU(tRTP(min)/tCK) = 2



7.4.10.2 Burst Read Followed by Precharge: RL = 3, BL = 4, RU(tRTP(min)/tCK) = 3





7.4.11 Burst Write Followed by Precharge

For write cycles, a delay must be satisfied from the time of the last valid burst input data until the Precharge command may be issued. This delay is known as the write recovery time (t_{WR}) referenced from the completion of the burst write to the precharge command. No Precharge command to the same bank should be issued prior to the t_{WR} delay.

LPDDR2-S4 devices write data to the array in prefetch quadruples (prefetch = 4). The beginning of an internal write operation may only begin after a prefetch group has been latched completely. Therefore, the write recovery time (t_{WR}) starts at different boundaries.

The minimum Write to Precharge command spacing to the same bank is $WL + BL/2 + 1 + RU(t_{WR}/t_{CK})$ clock cycles. For an untruncated burst, BL is the value from the Mode Register. For a truncated burst, BL is the effective burst length.

See 7.4.14.2 “Precharge & Auto Precharge Clarification” table for Write to Precharge timings.

7.4.11.1 Burst Write Followed by Precharge: $WL = 1, BL = 4$

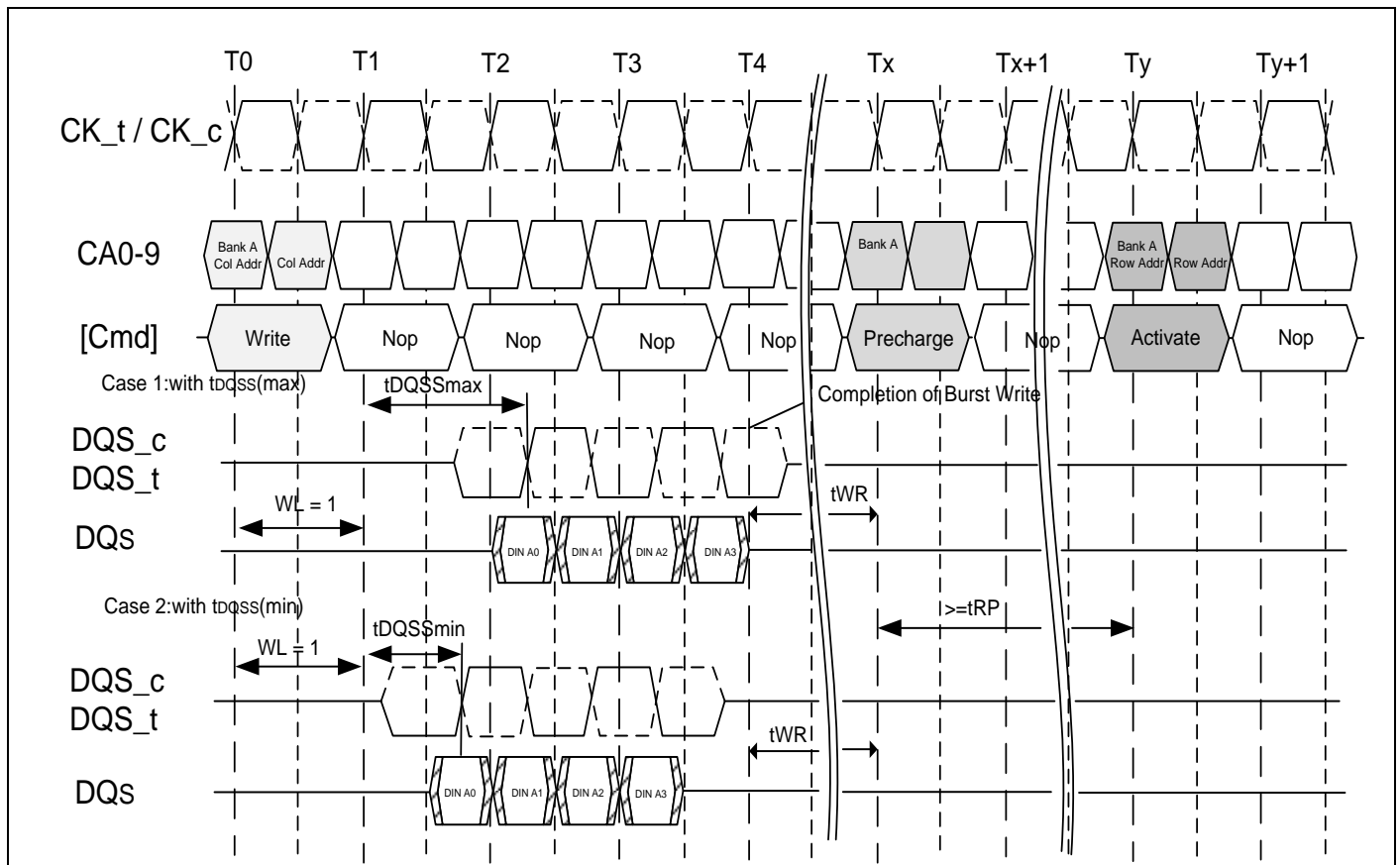



7.4.12 Auto Precharge Operation

Before a new row in an active bank can be opened, the active bank must be precharged using either the Precharge command or the auto-precharge function. When a Read or a Write command is given to the LPDDR2 SDRAM, the AP bit (CA0f) may be set to allow the active bank to automatically begin precharge at the earliest possible moment during the burst read or write cycle.

If AP is LOW when the Read or Write command is issued, then normal Read or Write burst operation is executed and the bank remains active at the completion of the burst.

If AP is HIGH when the Read or Write command is issued, then the auto-precharge function is engaged. This feature allows the precharge operation to be partially or completely hidden during burst read cycles (dependent upon Read or Write latency) thus improving system performance for random data access.

7.4.13 Burst Read with Auto-Precharge

If AP (CA0f) is HIGH when a Read Command is issued, the Read with Auto-Precharge function is engaged.

LPDDR2-S4 devices start an Auto-Precharge operation on the rising edge of the clock BL/2 or BL/2 - 2 + RU(tRTP/tCK) clock cycles later than the Read with AP command, whichever is greater. Refer to section 7.4.14.2 “Precharge & Auto Precharge Clarification” table for equations related to Auto-Precharge for LPDDR2-S4.

A new bank Activate command may be issued to the same bank if both of the following two conditions are satisfied simultaneously.

- The RAS precharge time (tRP) has been satisfied from the clock at which the auto precharge begins.
- The RAS cycle time (tRC) from the previous bank activation has been satisfied.

7.4.13.1 Burst Read with Auto-Precharge: RL = 3, BL = 4, RU(tRTP(min)/tCK) = 2

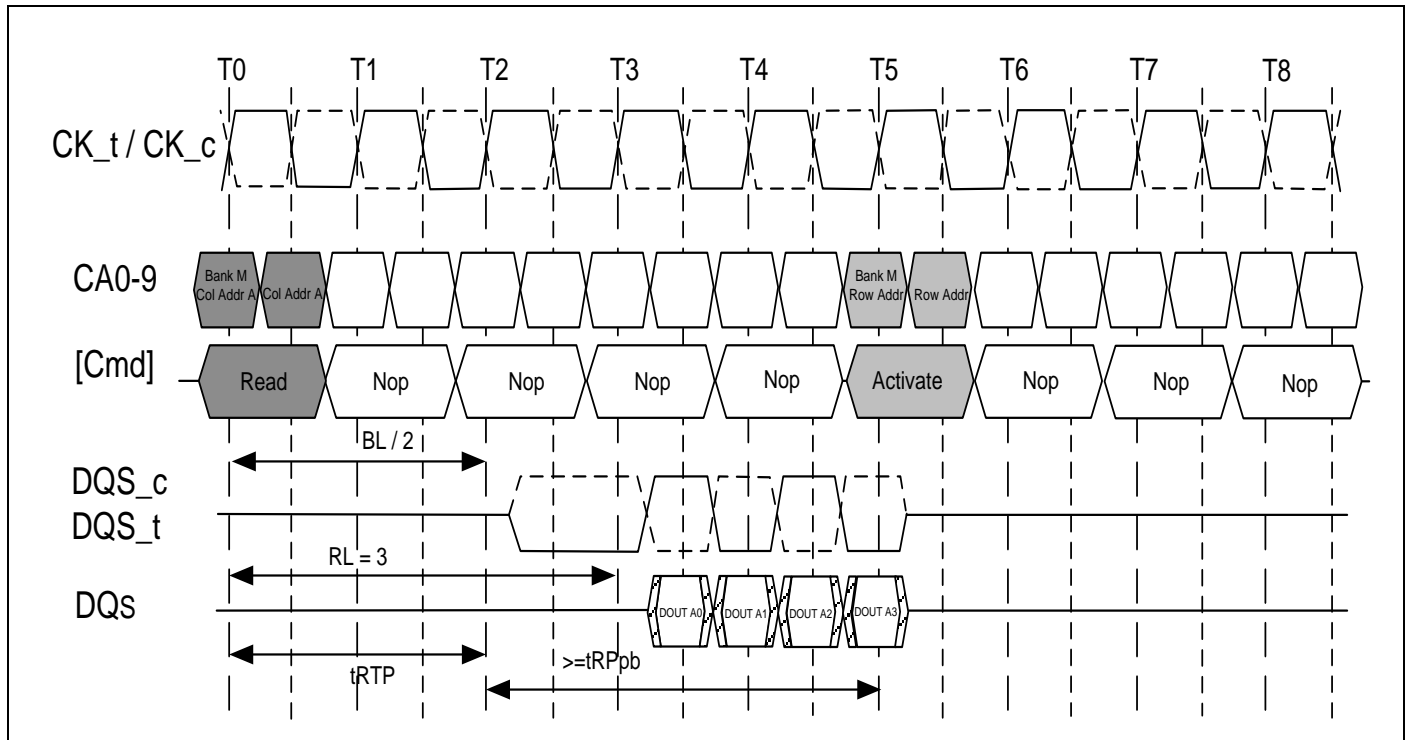



7.4.14 Burst Write with Auto-Precharge

If AP (CA0f) is HIGH when a Write Command is issued, the Write with Auto-Precharge function is engaged. The LPDDR2 SDRAM starts an Auto Precharge operation on the rising edge which is t_{WR} cycles after the completion of the burst write.

A new bank activate (command) may be issued to the same bank if both of the following two conditions are satisfied.

- The RAS precharge time (t_{RP}) has been satisfied from the clock at which the auto precharge begins.
- The RAS cycle time (t_{RC}) from the previous bank activation has been satisfied.

7.4.14.1 Burst Write with Auto-Precharge: WL = 1, BL = 4





7.4.14.2 Precharge & Auto Precharge Clarification

From Command	To Command	Minimum Delay between "From Command" to "To Command"	Unit	Notes
Read	Precharge (to same Bank as Read)	$BL/2 + \max(2, RU(tRTP/tCK)) - 2$	CLK	1
	Precharge All	$BL/2 + \max(2, RU(tRTP/tCK)) - 2$	CLK	1
BST (for Reads)	Precharge (to same Bank as Read)	1	CLK	1
	Precharge All	1	CLK	1
Read w/AP	Precharge (to same Bank as Read w/AP)	$BL/2 + \max(2, RU(tRTP/tCK)) - 2$	CLK	1, 2
	Precharge All	$BL/2 + \max(2, RU(tRTP/tCK)) - 2$	CLK	1
	Activate (to same Bank as Read w/AP)	$BL/2 + \max(2, RU(tRTP/tCK)) - 2 + RU(tRPpb/tCK)$	CLK	1
	Write or Write w/AP (same bank)	Illegal	CLK	3
	Write or Write w/AP (different bank)	$RL + BL/2 + RU(tDQSCkmax/tCK) - WL + 1$	CLK	3
	Read or Read w/AP (same bank)	Illegal	CLK	3
	Read or Read w/AP (different bank)	$BL/2$	CLK	3
Write	Precharge (to same Bank as Write)	$WL + BL/2 + RU(tWR/tCK) + 1$	CLK	1
	Precharge All	$WL + BL/2 + RU(tWR/tCK) + 1$	CLK	1
BST (for Writes)	Precharge (to same Bank as Write)	$WL + RU(tWR/tCK) + 1$	CLK	1
	Precharge All	$WL + RU(tWR/tCK) + 1$	CLK	1
Write w/AP	Precharge (to same Bank as Write w/AP)	$WL + BL/2 + RU(tWR/tCK) + 1$	CLK	1
	Precharge All	$WL + BL/2 + RU(tWR/tCK) + 1$	CLK	1
	Activate (to same Bank as Write w/AP)	$WL + BL/2 + RU(tWR/tCK) + 1 + RU(tRPpb/tCK)$	CLK	1
	Write or Write w/AP (same bank)	Illegal	CLK	3
	Write or Write w/AP (different bank)	$BL/2$	CLK	3
	Read or Read w/AP (same bank)	Illegal	CLK	3
	Read or Read w/AP (different bank)	$WL + BL/2 + RU(tWTR/tCK) + 1$	CLK	3
Precharge	Precharge (to same Bank as Precharge)	1	CLK	1
	Precharge All	1	CLK	1
Precharge All	Precharge	1	CLK	1
	Precharge All	1	CLK	1

Notes:

- For a given bank, the precharge period should be counted from the latest precharge command, either one bank precharge or precharge all, issued to that bank. The precharge period is satisfied after tRP depending on the latest precharge command issued to that bank.
- Any command issued during the specified minimum delay time is illegal.
- After Read with AP, seamless read operations to different banks are supported. After Write with AP, seamless write operations to different banks are supported. Read w/AP and Write w/AP may not be interrupted or truncated.



7.4.15 Refresh Command

The Refresh command is initiated by having CS_n LOW, CA0 LOW, CA1 LOW, and CA2 HIGH at the rising edge of clock. Per Bank Refresh is initiated by having CA3 LOW at the rising edge of clock and All Bank Refresh is initiated by having CA3 HIGH at the rising edge of clock. Per Bank Refresh is only allowed in devices with 8 banks.

A Per Bank Refresh command, REFpb performs a refresh operation to the bank which is scheduled by the bank counter in the memory device. The bank sequence of Per Bank Refresh is fixed to be a sequential round-robin: "0-1-2-3-4-5-6-7-0-1-...". The bank count is synchronized between the controller and the SDRAM upon issuing a RESET command or at every exit from self refresh, by resetting bank count to zero. The bank addressing for the Per Bank Refresh count is the same as established in the single-bank Precharge command (See 7.4.9.1 "**Bank Selection for Precharge by Address Bits**" table).

A bank must be idle before it can be refreshed. It is the responsibility of the controller to track the bank being refreshed by the Per Bank Refresh command.

As shown in 7.4.15.1 "**Command Scheduling Separations Related to Refresh**" table, the REFpb command may not be issued to the memory until the following conditions have been met:

- a) The tRFC_{ab} has been satisfied after the prior REFab command
- b) The tRFC_{pb} has been satisfied after the prior REFpb command
- c) The tRP has been satisfied after prior Precharge commands to that given bank

The tRRD has been satisfied after the prior ACTIVATE command (if applicable, for example after activating a row in a different bank than affected by the REFpb command).

The target bank is inaccessible during the Per Bank Refresh cycle time (tRFC_{pb}), however other banks within the device are accessible and may be addressed during the Per Bank Refresh cycle. During the REFpb operation, any of the banks other than the one being refreshed can be maintained in active state or accessed by a read or a write command.

When the Per Bank refresh cycle has completed, the affected bank will be in the Idle state.

As shown in 7.4.15.1 "**Command Scheduling Separations Related to Refresh**" table, after issuing REFpb:

- a) The tRFC_{pb} must be satisfied before issuing a REFab command
- b) The tRFC_{pb} must be satisfied before issuing an ACTIVATE command to the same bank
- c) The tRRD must be satisfied before issuing an ACTIVATE command to a different bank
- d) The tRFC_{pb} must be satisfied before issuing another REFpb command

An All Bank Refresh command, REFab performs a refresh operation to all banks. All banks have to be in Idle state when REFab is issued (for instance, by Precharge all-bank command). REFab also synchronizes the bank count between the controller and the SDRAM to zero.

As shown in 7.4.15.1 "**Command Scheduling Separations Related to Refresh**" table, the REFab command may not be issued to the memory until the following conditions have been met:

- a) The tRFC_{ab} has been satisfied after the prior REFab command
- b) The tRFC_{pb} has been satisfied after the prior REFpb command
- c) The tRP has been satisfied after prior Precharge commands

When the All Bank refresh cycle has completed, all banks will be in the Idle state.

As shown in 7.4.15.1 "**Command Scheduling Separations Related to Refresh**" table, after issuing REFab:

- a) The tRFC_{ab} latency must be satisfied before issuing an ACTIVATE command
- b) The tRFC_{ab} latency must be satisfied before issuing a REFab or REFpb command



7.4.15.1 Command Scheduling Separations Related to Refresh

Symbol	minimum delay from	to	Note
tRFCab	REFab	REFab	
		Activate cmd to any bank	
		REFpb	
tRFCpb	REFpb	REFab	
		Activate cmd to same bank as REFpb	
		REFpb	
tRRD	REFpb	Activate cmd to different bank than REFpb	
	Activate	REFpb affecting an idle bank (different bank than Activate)	1
		Activate cmd to different bank than prior Activate	

Note:

- A bank must be in the Idle state before it is refreshed. Therefore, after Activate, REFab is not allowed and REFpb is allowed only if it affects a bank which is in the Idle state.

7.4.16 LPDDR2 SDRAM Refresh Requirements

(1) Minimum number of Refresh commands:

The LPDDR2 SDRAM requires a minimum number of R Refresh (REFab) commands within any rolling Refresh Window ($t_{REFW} = 32 \text{ mS} @ \text{MR4}[2:0] = "011"$ or $T_{CASE} \leq 85^{\circ}\text{C}$). The required minimum number of Refresh commands and resulting average refresh interval (t_{REFI}) are given in 8.6.1 “Refresh Requirement Parameters” table.

See Mode Register 4 for t_{REFW} and t_{REFI} refresh multipliers at different MR4 settings.

(2) Burst Refresh limitation:

To limit maximum current consumption, a maximum of 8 REFab commands may be issued in any rolling t_{REFBW} ($t_{REFBW} = 4 \times 8 \times t_{RFCab}$). This condition does not apply if REFpb commands are used.

(3) Refresh Requirements and Self-Refresh:

If any time within a refresh window is spent in Self-Refresh Mode, the number of required Refresh commands in this particular window is reduced to:

$$R^* = R - \text{RU}\{t_{SRF} / t_{REFI}\} = R - \text{RU}\{R * t_{SRF} / t_{REFW}\}; \text{ where RU stands for the round-up function.}$$



7.4.16.1 Definition of tSRF

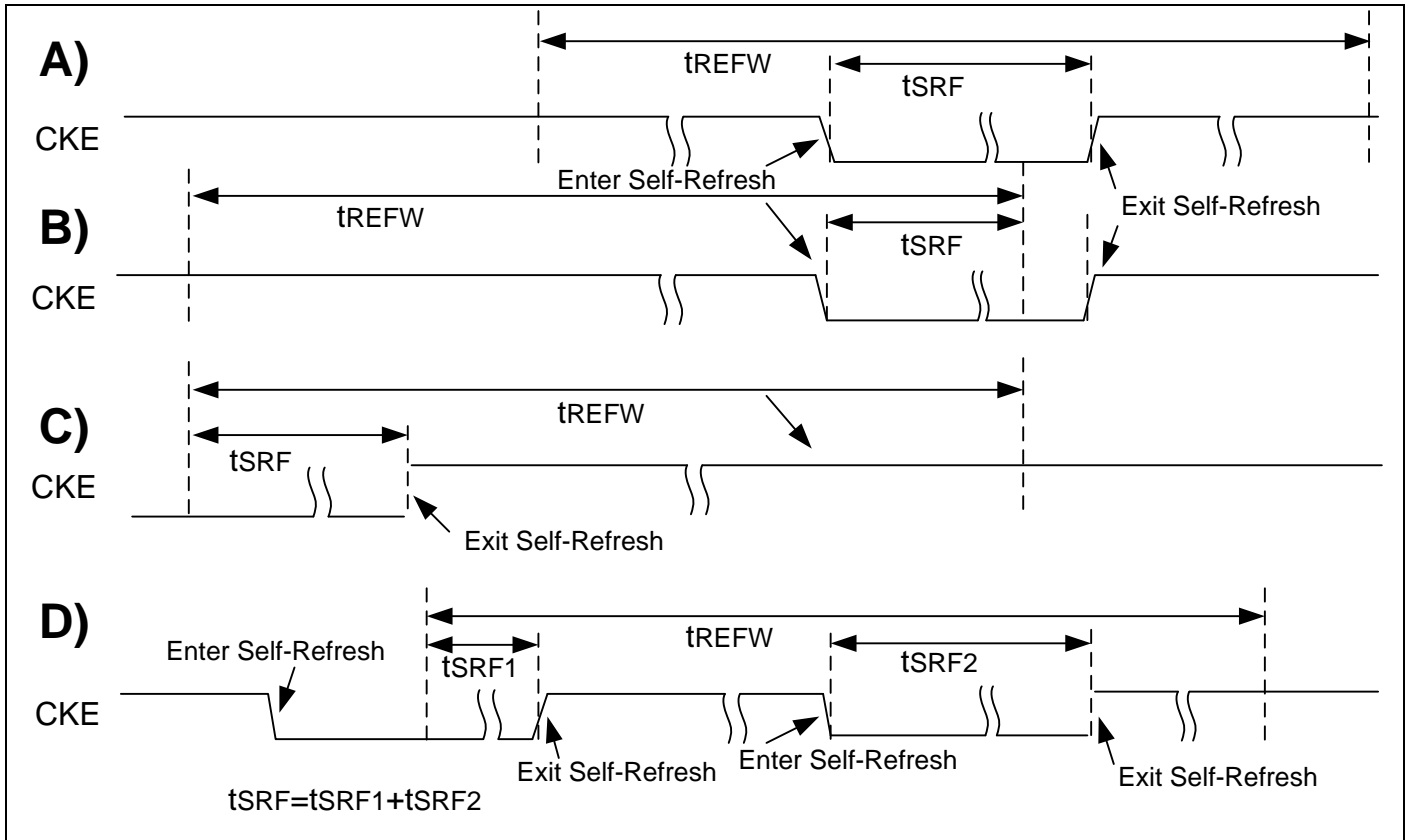

Several examples on how tSRF is calculated:

A: with the time spent in Self-Refresh Mode fully enclosed in the Refresh Window (tREFW).

B: at Self-Refresh entry.

C: at Self-Refresh exit.

D: with several different intervals spent in Self Refresh during one tREFW interval.



In contrast to JESD79 and JESD79-2 and JESD79-3 compliant SDRAM devices, LPDDR2-S4 devices allow significant flexibility in scheduling REFRESH commands, as long as the boundary conditions above are met. In the most straight forward case a REFRESH command should be scheduled every t_{REFI} . In this case Self-Refresh may be entered at any time.

The users may choose to deviate from this regular refresh pattern e.g., to enable a period where no refreshes are required. As an example, using a 1Gb LPDDR2-S4 device, the user can choose to issue a refresh burst of 4096 REFRESH commands with the maximum allowable rate (limited by t_{REFBW}) followed by a long time without any REFRESH commands, until the refresh window is complete, then repeating this sequence. The achievable time without REFRESH commands is given by $t_{REFW} - (R / 8) * t_{REFBW} = t_{REFW} - R * 4 * t_{RFCab}$. @ $T_{CASE} \leq 85^{\circ}C$ this can be up to $32 \text{ mS} - 4096 * 4 * 130 \text{ nS} \approx 30 \text{ mS}$.

While both - the regular and the burst/pause - patterns can satisfy the refresh requirements per rolling refresh interval, if they are repeated in every subsequent 32 mS window, extreme care must be taken when transitioning from one pattern to another to satisfy the refresh requirement in every rolling refresh window during the transition.

Figure of **7.4.16.3** shows an example of an allowable transition from a burst pattern to a regular, distributed pattern. If this transition happens directly after the burst refresh phase, all rolling t_{REFW} intervals will have at least the required number of REFRESH commands.

Figure of **7.4.16.4** shows an example of a non-allowable transition. In this case the regular refresh pattern starts after the completion of the pause-phase of the burst/pause refresh pattern. For several rolling t_{REFW} intervals the minimum number of REFRESH commands is not satisfied.

The understanding of the pattern transition is extremely relevant (even if in normal operation only one pattern is employed), as in Self-Refresh-Mode a regular, distributed refresh pattern has to be assumed, which is reflected in the equation for R^* above. Therefore it is recommended to enter Self-Refresh-Mode **ONLY** directly after the burst-phase of a burst/pause refresh pattern as indicated in figure of **7.4.16.5** and begin with the burst phase upon exit from Self-Refresh.



7.4.16.2 Regular, Distributed Refresh Pattern

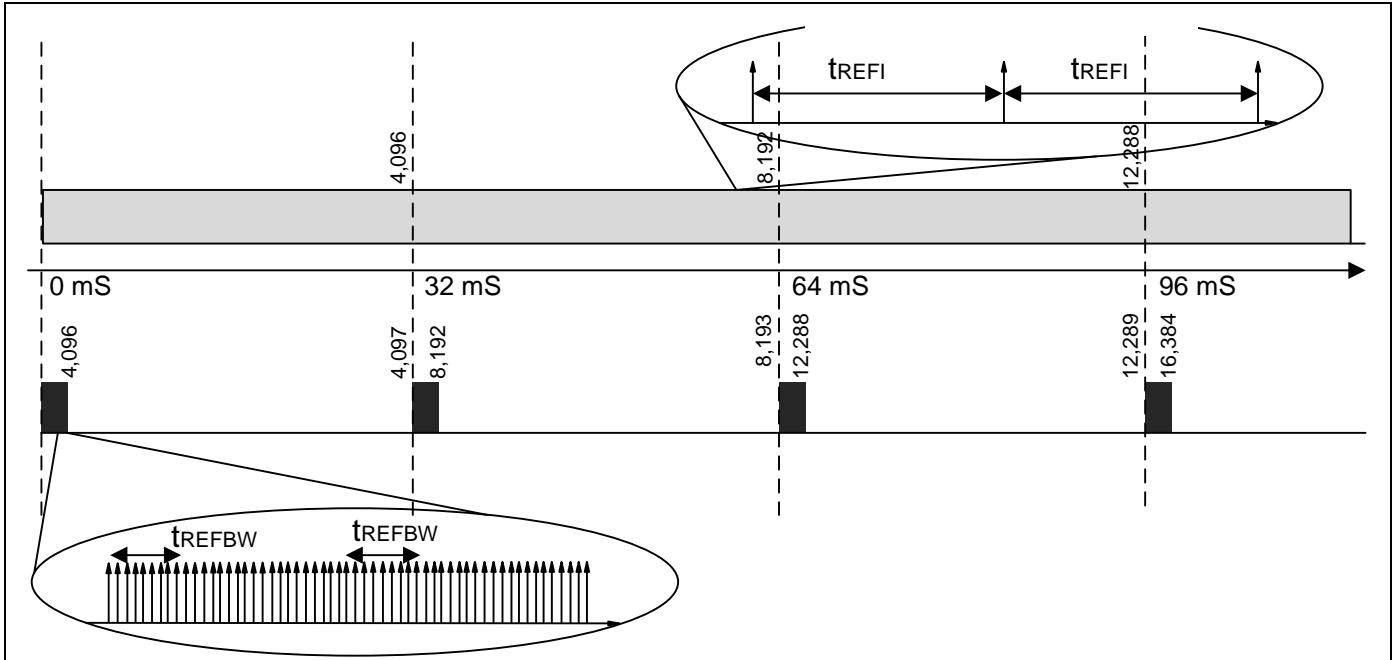

Notes:

1. Compared to repetitive burst Refresh with subsequent Refresh pause.
2. For an example, in a 1Gb LPDDR2 device at TCASE ≤ 85°C, the distributed refresh pattern would have one REFRESH command per 7.8 μS; the burst refresh pattern would have an average of one refresh command per 0.52 μS followed by ≈30 mS without any REFRESH command.

7.4.16.3 Allowable Transition from Repetitive Burst Refresh

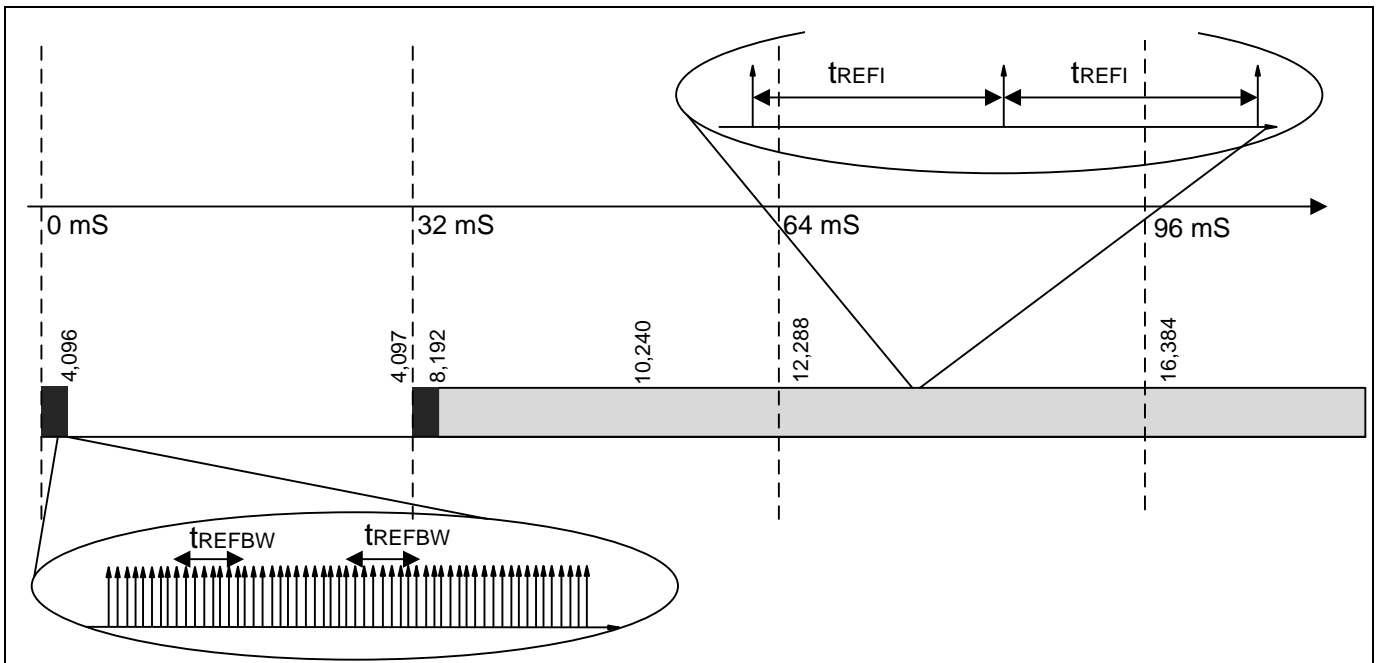

Notes:

1. Shown with subsequent Refresh pause to regular distributed Refresh pattern.
2. For an example, in a 1Gb LPDDR2 device at TCASE ≤ 85°C, the distributed refresh pattern would have one REFRESH command per 7.8 μS; the burst refresh pattern would have an average of one refresh command per 0.52 μS followed by ≈30 mS without any REFRESH command.



7.4.16.4 NOT-Allowable Transition from Repetitive Burst Refresh

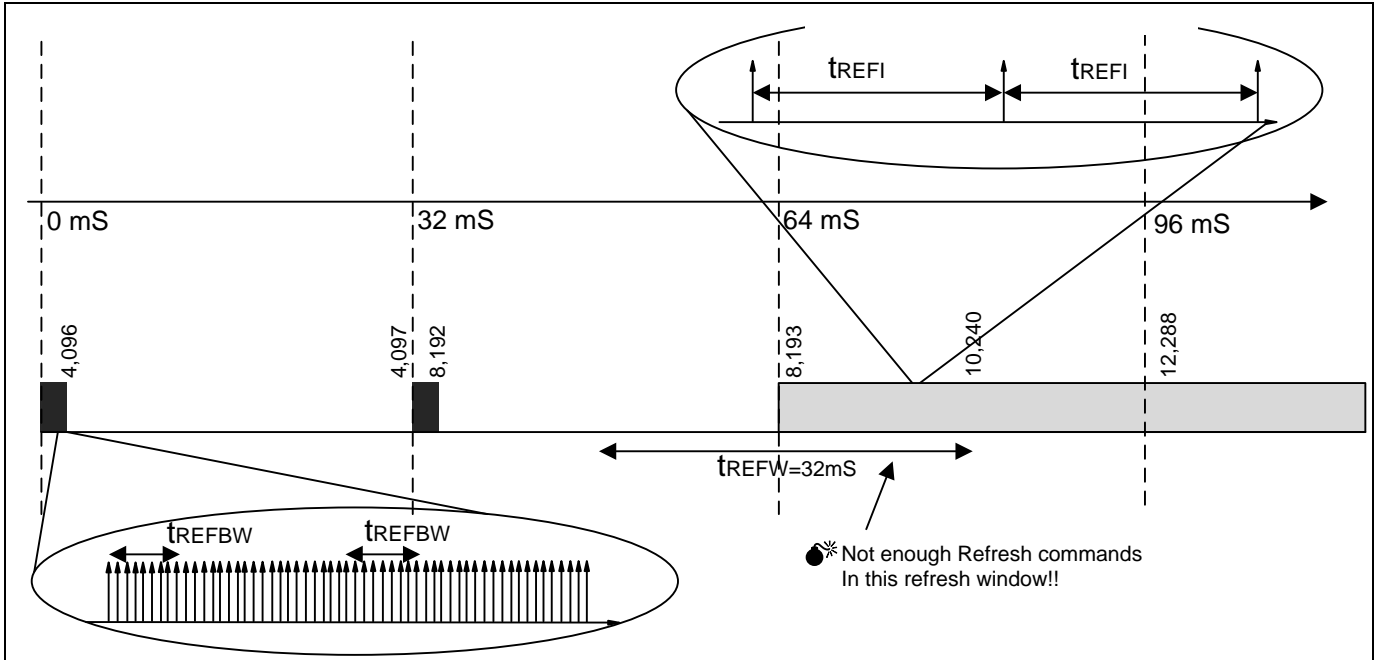

Notes:

1. Shown with subsequent Refresh pause to regular distributed Refresh pattern.
2. Only ≈ 2048 REFRESH commands ($< R$ which is 4096) in the indicated t_{REFW} window.

7.4.16.5 Recommended Self-Refresh Entry and Exit

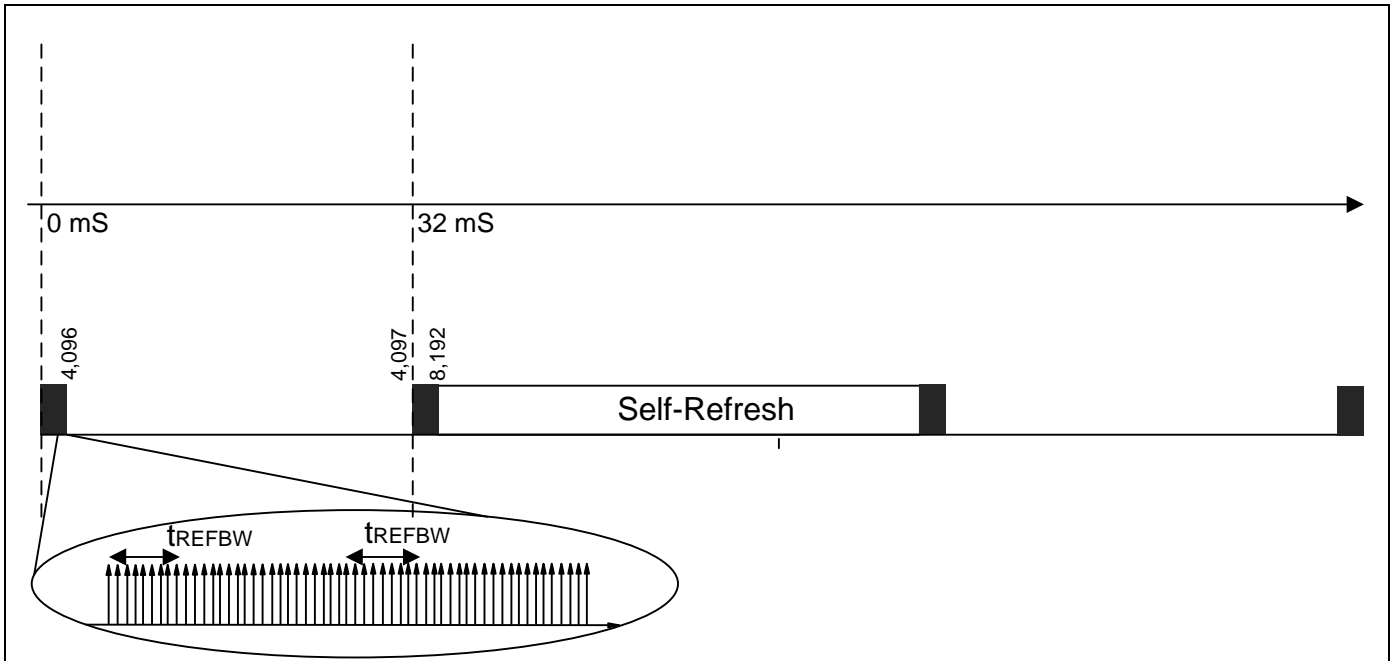

Note:

1. In conjunction with a Burst/Pause Refresh patterns.



7.4.16.6 All Bank Refresh Operation

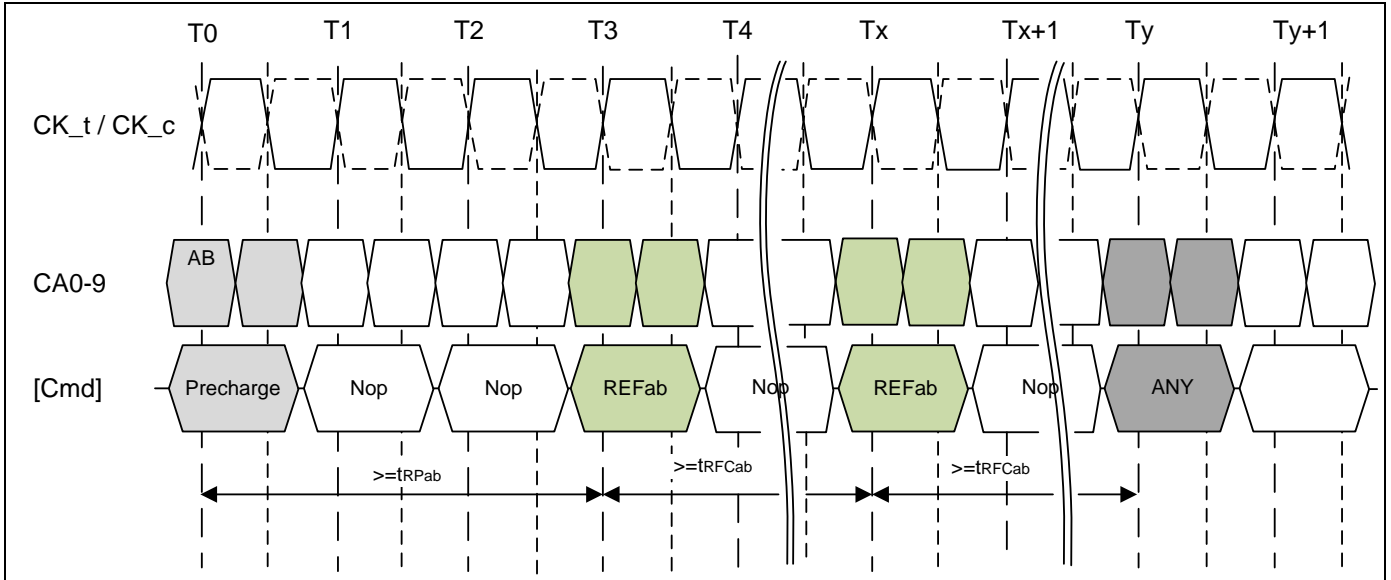

7.4.16.7 Per Bank Refresh Operation

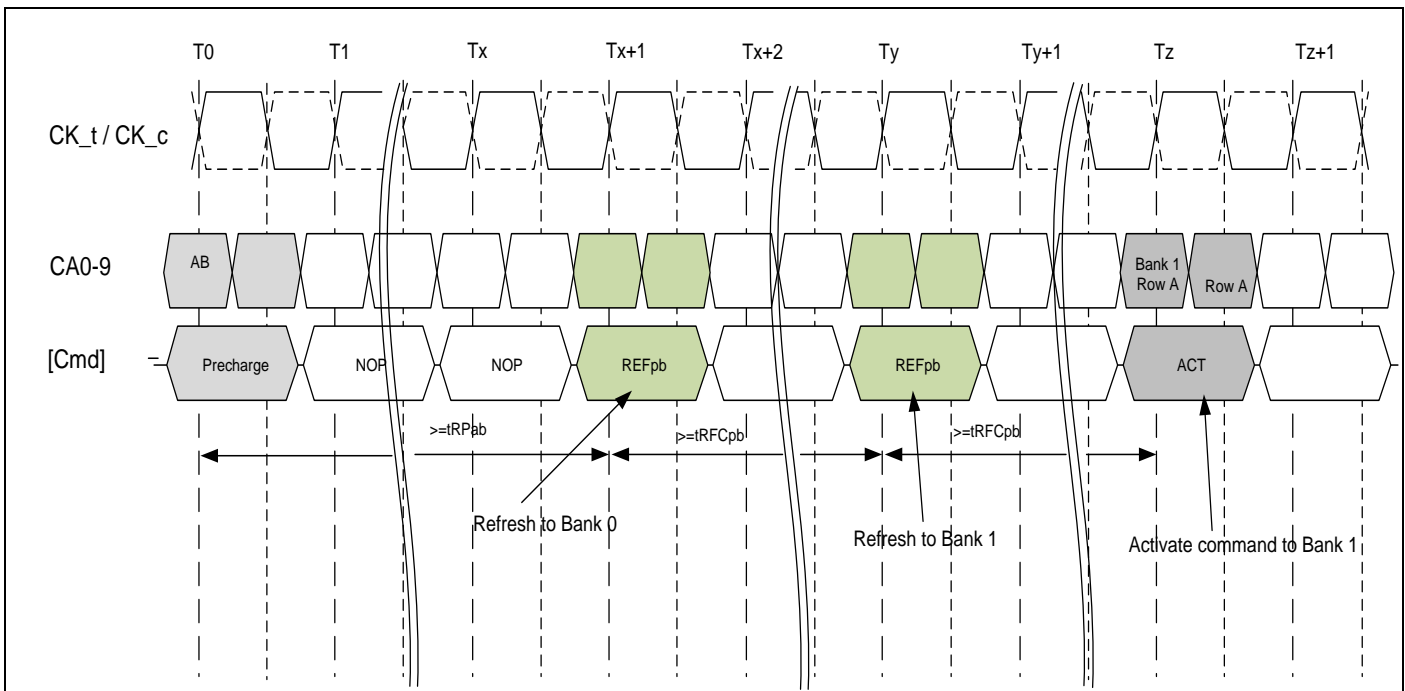

Notes:

1. In the beginning of this example, the REFpb bank is pointing to Bank 0.
2. Operations to other banks than the bank being refreshed are allowed during the tRFCpb period.



7.4.17 Self Refresh Operation

The Self Refresh command can be used to retain data in the LPDDR2 SDRAM, even if the rest of the system is powered down. When in the Self Refresh mode, the LPDDR2 SDRAM retains data without external clocking. The LPDDR2 SDRAM device has a built-in timer to accommodate Self Refresh operation. The Self Refresh Command is defined by having CKE LOW, CS_n LOW, CA0 LOW, CA1 LOW, and CA2 HIGH at the rising edge of the clock. CKE must be HIGH during the previous clock cycle. A NOP command must be driven in the clock cycle following the power-down command. Once the command is registered, CKE must be held LOW to keep the device in Self Refresh mode.

LPDDR2-S4 devices can operate in Self Refresh in either the Standard or Extended Temperature Ranges. LPDDR2-S4 devices will also manage Self Refresh power consumption when the operating temperature changes, lower at low temperatures and higher temperatures.

Once the LPDDR2 SDRAM has entered Self Refresh mode, all of the external signals except CKE, are “don't care”. For proper self refresh operation, power supply pins (VDD1, VDD2, and VDDCA) must be at valid levels. VDDQ may be turned off during Self-Refresh. Prior to exiting Self-Refresh, VDDQ must be within specified limits. VrefDQ and VrefCA may be at any level within minimum and maximum levels (see section 8.1 “**Absolute Maximum DC Ratings**” table). However prior to exit Self-Refresh, VrefDQ and VrefCA must be within specified limits (see section 8.2.1.1 “**Recommended DC Operating Conditions**” table). The SDRAM initiates a minimum of one all-bank refresh command internally within tCKESR period once it enters Self Refresh mode. The clock is internally disabled during Self Refresh Operation to save power. The minimum time that the LPDDR2 SDRAM must remain in Self Refresh mode is tCKESR. The user may change the external clock frequency or halt the external clock one clock after Self Refresh entry is registered; however, the clock must be restarted and stable before the device can exit Self Refresh operation.

The procedure for exiting Self Refresh requires a sequence of commands. First, the clock shall be stable and within specified limits for a minimum of 2 clock cycles prior to CKE going back HIGH. Once Self Refresh Exit is registered, a delay of at least tXSR must be satisfied before a valid command can be issued to the device to allow for any internal refresh in progress. CKE must remain HIGH for the entire Self Refresh exit period tXSR for proper operation except for self refresh re-entry. NOP commands must be registered on each positive clock edge during the Self Refresh exit interval tXSR.

The use of Self Refresh mode introduces the possibility that an internally timed refresh event can be missed when CKE is raised for exit from Self Refresh mode. Upon exit from Self Refresh, it is required that at least one Refresh command (8 per-bank or 1 all-bank) is issued before entry into a subsequent Self Refresh.



For LPDDR2 SDRAM, the maximum duration in power-down mode is only limited by the refresh requirements outlined in section 7.4.16 “LPDDR2 SDRAM Refresh Requirements”, since no refresh operations are performed in power-down mode.

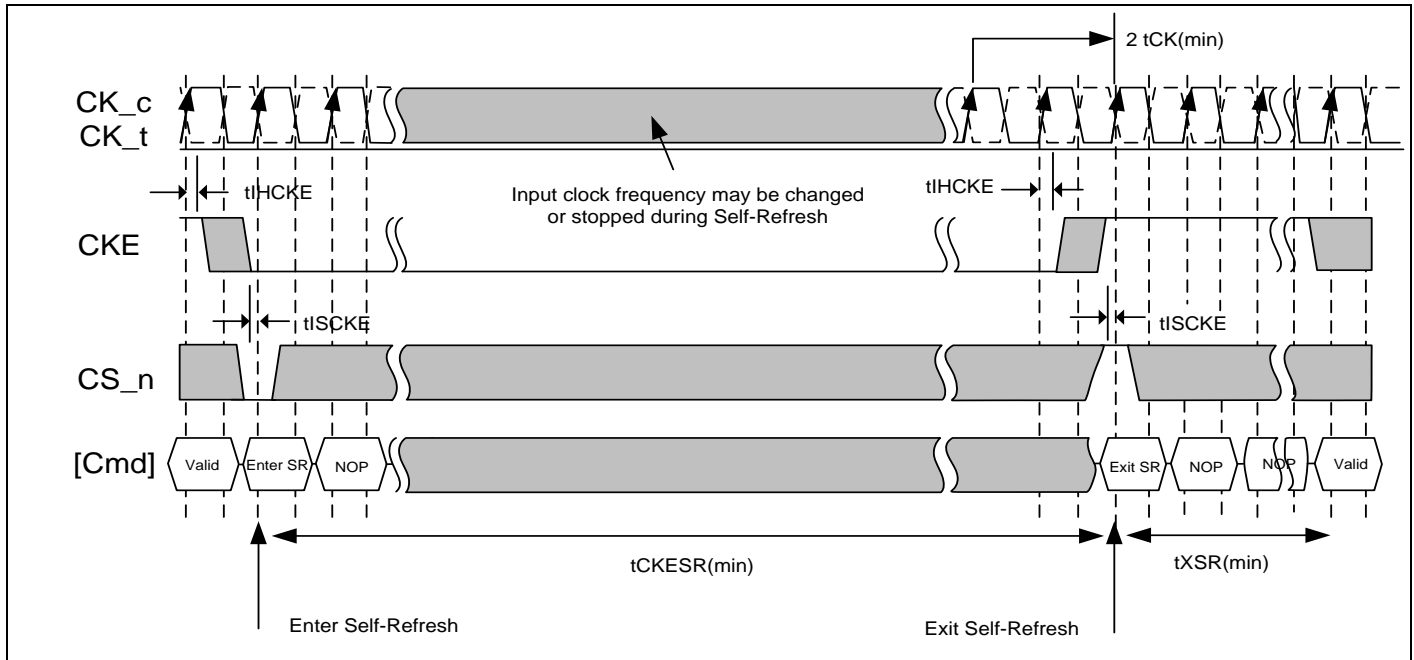

Figure of Self Refresh Operation

Notes:

1. Input clock frequency may be changed or stopped during self-refresh, provided that upon exiting self-refresh, a minimum of 2 clocks of stable clock are provided and the clock frequency is between the minimum and maximum frequency for the particular speed grad
2. Device must be in the “All banks idle” state prior to entering Self Refresh mode.
3. tXSR begins at the rising edge of the clock after CKE is driven HIGH.
4. A valid command may be issued only after tXSR is satisfied. NOPs shall be issued during tXSR.

7.4.18 Partial Array Self-Refresh: Bank Masking

Each bank of LPDDR2 SDRAM can be independently configured whether a self refresh operation is taking place. One mode register unit of 8 bits accessible via MRW command is assigned to program the bank masking status of each bank up to 8 banks. For bank masking bit assignments, see section 7.3.13 Mode Register 16 “MR16_PASR_Bank Mask (MA[7:0] = 10H)”.

The mask bit to the bank controls a refresh operation of entire memory within the bank. If a bank is masked via MRW, a refresh operation to the entire bank is blocked and data retention by a bank is not guaranteed in self refresh mode. To enable a refresh operation to a bank, a coupled mask bit has to be programmed, “unmasked”. When a bank mask bit is unmasked, a refresh to a bank is determined by the programmed status of segment mask bits.

7.4.19 Partial Array Self-Refresh: Segment Masking

Segment masking scheme may be used in place of or in combination with bank masking scheme in LPDDR2-S4 SDRAM. The number of segments differ by the density and the setting of each segment mask bit is applied across all the banks. For segment masking bit assignments, see section 7.3.14 Mode Register 17 “MR17_PASR_Segment Mask (MA[7:0] = 11H)”.

For those refresh-enabled banks, a refresh operation to the address range which is represented by a segment is blocked when the mask bit to this segment is programmed, “masked”. Programming of segment mask bits is similar to the one of bank mask bits.



Table of Example of Bank and Segment Masking use in LPDDR2-S4 devices

	Segment Mask(MR17)	Bank 0	Bank 1	Bank 2	Bank 3	Bank 4	Bank 5	Bank 6	Bank 7
BankMask (MR16)		0	1	0	0	0	0	0	1
Segment 0	0	-	M	-	-	-	-	-	M
Segment 1	0	-	M	-	-	-	-	-	M
Segment 2	1	M	M	M	M	M	M	M	M
Segment 3	0	-	M	-	-	-	-	-	M
Segment 4	0	-	M	-	-	-	-	-	M
Segment 5	0	-	M	-	-	-	-	-	M
Segment 6	0	-	M	-	-	-	-	-	M
Segment 7	1	M	M	M	M	M	M	M	M

Note:

This table illustrates an example of an 8-bank LPDDR2-S4 device, when a refresh operation to bank 1 and bank 7, as well as segment 2 and segment 7 are masked

7.4.20 Mode Register Read Command

The Mode Register Read command is used to read configuration and status data from mode registers. The Mode Register Read (MRR) command is initiated by having CS_n LOW, CA0 LOW, CA1 LOW, CA2 LOW, and CA3 HIGH at the rising edge of the clock. The mode register is selected by {CA1f-CA0f, CA9r-CA4r}. The mode register contents are available on the first data beat of DQ[0:7], RL * t_{CK} + t_{DQSCK} + t_{DQSQ} after the rising edge of the clock where the Mode Register Read Command is issued. Subsequent data beats contain valid, but undefined content, except in the case of the DQ Calibration function DQC, where subsequent data beats contain valid content as described in section 7.4.21.2 “**DQ Calibration**”. All DQS_t, DQS_c shall be toggled for the duration of the Mode Register Read burst.

The MRR command has a burst length of four. The Mode Register Read operation (consisting of the MRR command and the corresponding data traffic) shall not be interrupted. The MRR command period (t_{MRR}) is 2 clock cycles. Mode Register Reads to reserved and write-only registers shall return valid, but undefined content on all data beats and DQS_t, DQS_c shall be toggled.



7.4.20.1 Mode Register Read Timing Example: $RL = 3$, $tMRR = 2$

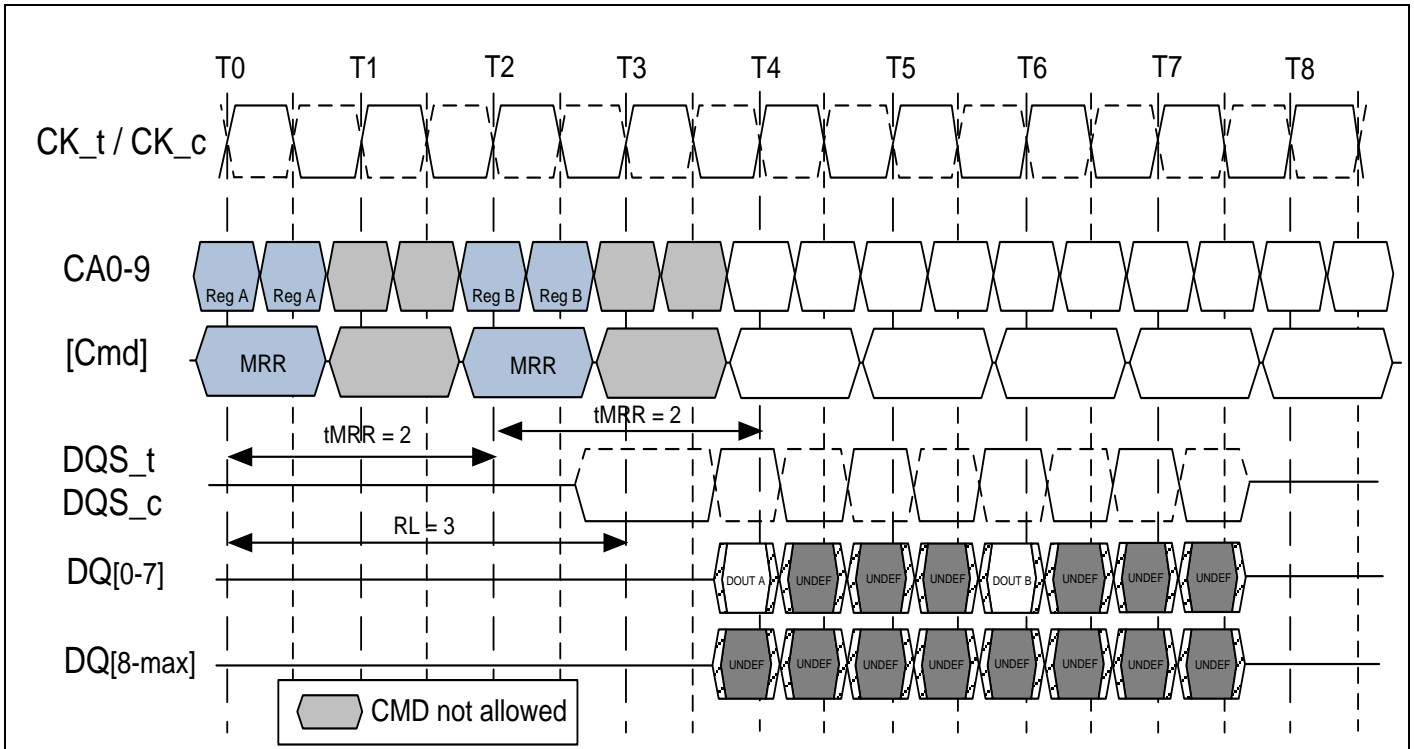

Notes:

1. Mode Register Read has a burst length of four.
2. Mode Register Read operation shall not be interrupted.
3. Mode Register data is valid only on DQ[0-7] on the first beat. Subsequent beats contain valid, but undefined data. DQ[8-max] contain valid, but undefined data for the duration of the MRR burst.
4. The Mode Register Command period is $tMRR$. No command (other than Nop) is allowed during this period.
5. Mode Register Reads to DQ Calibration registers MR32 and MR40 are described in the section on DQ Calibration.
6. Minimum Mode Register Read to write latency is $RL + RU(tDQCK_{max}/tCK) + 4/2 + 1 - WL$ clock cycles.
7. Minimum Mode Register Read to Mode Register Write latency is $RL + RU(tDQCK_{max}/tCK) + 4/2 + 1$ clock cycles.

The MRR command shall not be issued earlier than $BL/2$ clock cycles after a prior Read command and $WL + 1 + BL/2 + RU(tWTR/tCK)$ clock cycles after a prior Write command, because read-bursts and write-bursts shall not be truncated by MRR. Note that if a read or write burst is truncated with a Burst Terminate (BST) command, the effective burst length of the truncated burst should be used as "BL".



7.4.20.2 Read to MRR Timing Example: RL = 3, tMRR = 2

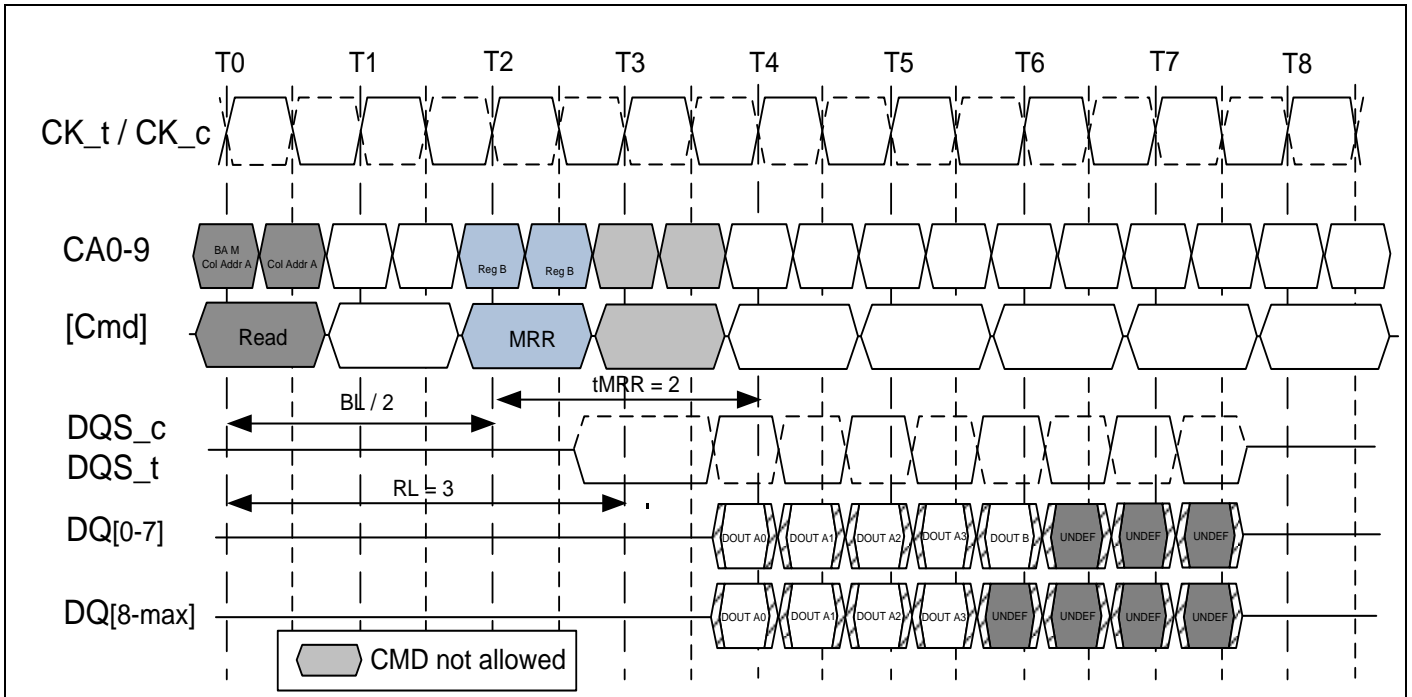

Notes:

1. The minimum number of clocks from the burst read command to the Mode Register Read command is BL/2.
2. The Mode Register Read Command period is tMRR. No command (other than Nop) is allowed during this period.

7.4.20.3 Burst Write Followed by MRR: RL = 3, WL = 1, BL = 4

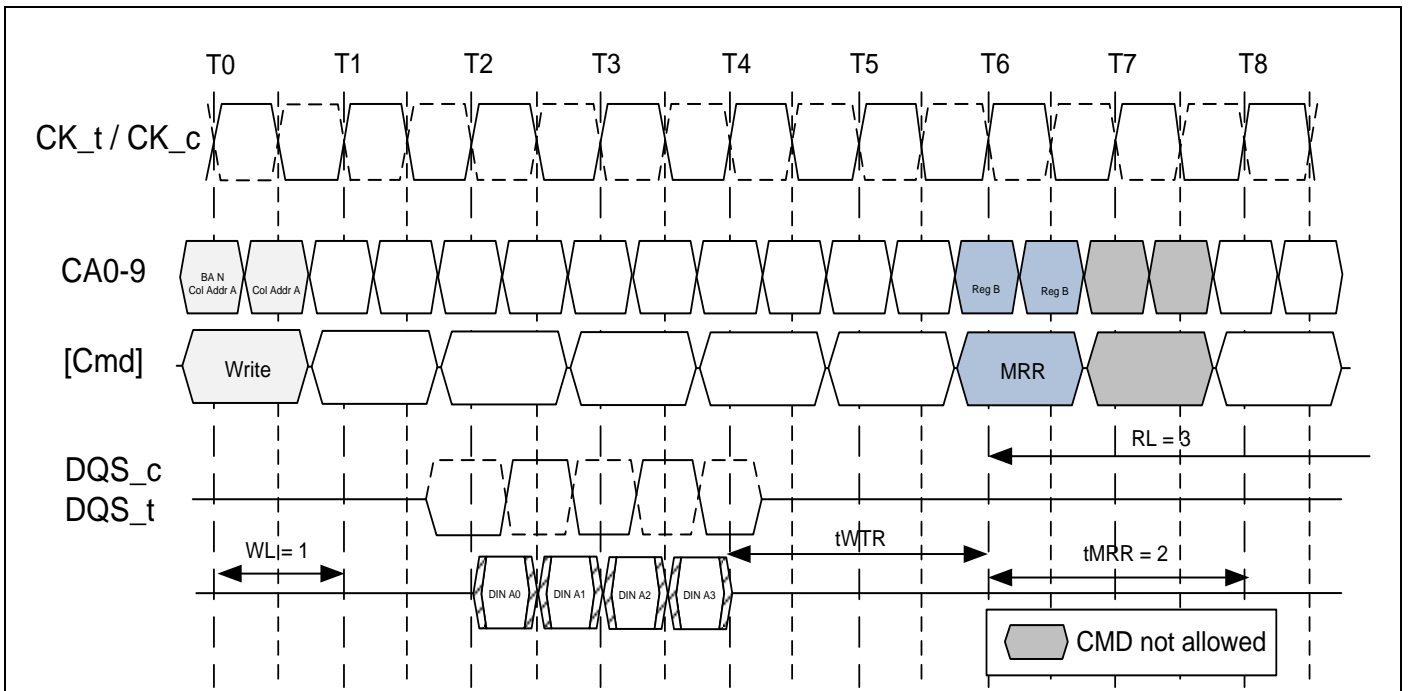

Notes:

1. The minimum number of clock cycles from the burst write command to the Mode Register Read command is [WL + 1 + BL/2 + RU (tWTR/tCK)].
2. The Mode Register Read Command period is tMRR. No command (other than Nop) is allowed during this period.



7.4.21 Temperature Sensor

LPDDR2 SDRAM features a temperature sensor whose status can be read from MR4. This sensor can be used to determine an appropriate refresh rate, determine whether AC timing derating is required in the Extended Temperature Range and/or monitor the operating temperature. Either the temperature sensor or the device operating temperature (See 8.2.3 “**Operating Temperature Conditions**” table) may be used to determine whether operating temperature requirements are being met.

LPDDR2 devices shall monitor device temperature and update MR4 according to tTSI. Upon exiting self-refresh or power-down, the device temperature status bits shall be no older than tTSI.

When using the temperature sensor, the actual device case temperature may be higher than the operating temperature specification (See 8.2.3 “**Operating Temperature Conditions**” table) that applies for the Standard or Extended Temperature Ranges. For example, TCASE may be above 85°C when MR4[2:0] equals 011b.

To assure proper operation using the temperature sensor, applications should consider the following factors:

TempGradient is the maximum temperature gradient experienced by the memory device at the temperature of interest over a range of 2°C.

ReadInterval is the time period between MR4 reads from the system.

TempSensorInterval (tTSI) is maximum delay between internal updates of MR4.

SysRespDelay is the maximum time between a read of MR4 and the response by the system.

LPDDR2 devices shall allow for a 2°C temperature margin between the point at which the device temperature enters the Extended Temperature Range and point at which the controller re-configures the system accordingly.

In order to determine the required frequency of polling MR4, the system shall use the maximum TempGradient and the maximum response time of the system using the following equation:

$$\text{TempGradient} \times (\text{ReadInterval} + t\text{TSI} + \text{SysRespDelay}) \leq 2^\circ\text{C}$$

Table of Temperature Sensor

Symbol	Parameter	Max/Min	Value	Unit
TempGradient	System Temperature Gradient	Max	System Dependent	°C/S
ReadInterval	MR4 Read Interval	Max	System Dependent	mS
tTSI	Temperature Sensor Interval	Max	32	mS
SysRespDelay	System Response Delay	Max	System Dependent	mS
TempMargin	Device Temperature Margin	Max	2	°C

For example, if TempGradient is 10°C/s and the SysRespDelay is 1 mS:

$$10^\circ\text{C/s} \times (\text{ReadInterval} + 32\text{mS} + 1\text{mS}) \leq 2^\circ\text{C}$$

In this case, ReadInterval shall be no greater than 167 mS.



7.4.21.1 Temperature Sensor Timing

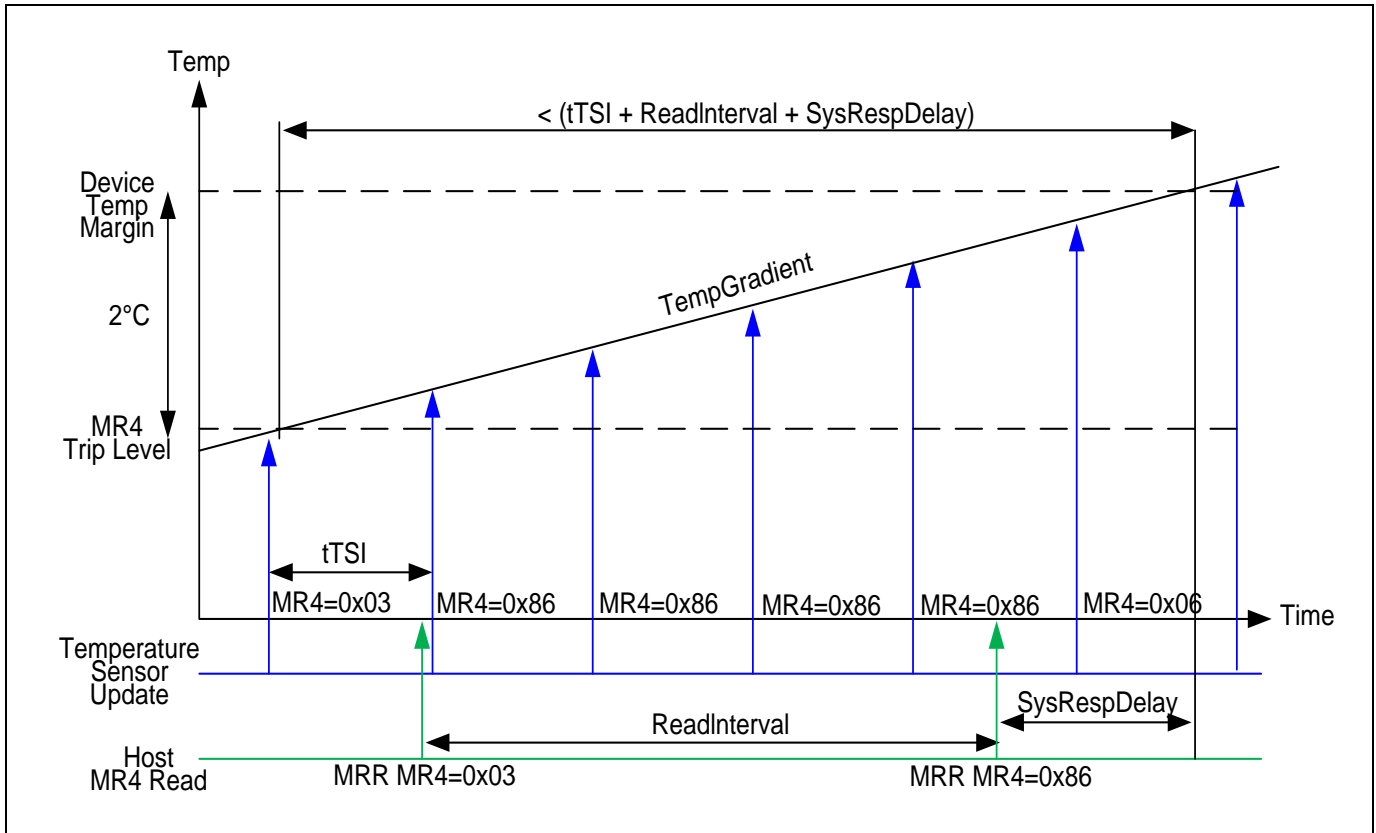

7.4.21.2 DQ Calibration

LPDDR2 device features a DQ Calibration function that outputs one of two predefined system timing calibration patterns. A Mode Register Read to MR32 (Pattern “A”) or MR40 (Pattern “B”) will return the specified pattern on DQ[0] and DQ[8] for x16 devices, and DQ[0], DQ[8], DQ[16], and DQ[24] for x32 devices.

For x16 devices, DQ[7:1] and DQ[15:9] may optionally drive the same information as DQ[0] or may drive 0b during the MRR burst. For x32 devices, DQ[7:1], DQ[15:9], DQ[23:17], and DQ[31:25] may optionally drive the same information as DQ[0] or may drive 0b during the MRR burst.

For LPDDR2-S4 devices, MRR DQ Calibration commands may only occur in the Idle state.

Table of Data Calibration Pattern Description

Pattern	MR#	Bit Time 0	Bit Time 1	Bit Time 2	Bit Time 3	Description
Pattern A	MR32	1	0	1	0	Read to MR32 return DQ calibration pattern A
Pattern B	MR40	0	0	1	1	Read to MR40 return DQ calibration pattern B



7.4.21.3 MR32 and MR40 DQ Calibration Timing Example: RL = 3, tMRR = 2

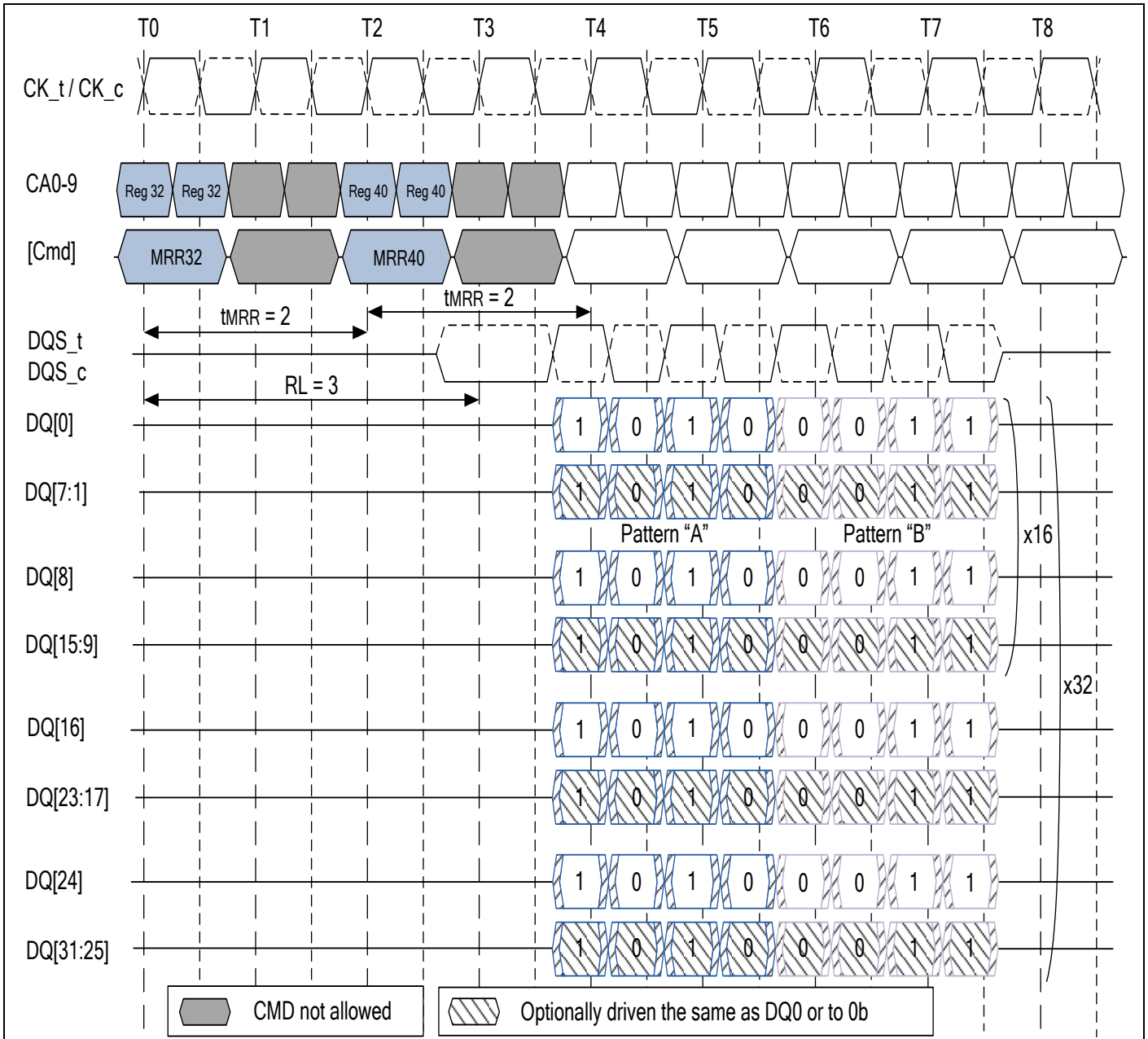

Notes:

1. Mode Register Read has a burst length of four.
2. Mode Register Read operation shall not be interrupted.
3. Mode Register Reads to MR32 and MR40 drive valid data on DQ[0] during the entire burst. For x16 devices, DQ[8] shall drive the same information as DQ[0] during the burst. For x32 devices, DQ[8], DQ[16], and DQ[24] shall drive the same information as DQ[0] during the burst.
4. For x16 devices, DQ[7:1] and DQ[15:9] may optionally drive the same information as DQ[0] or they may drive 0b during the burst. For x32 devices, DQ[7:1], DQ[15:9], DQ[23:17], and DQ[31:25] may optionally drive the same information as DQ[0] or they may drive 0b during the burst.
5. The Mode Register Command period is tMRR. No command (other than Nop) is allowed during this period.



7.4.22 Mode Register Write Command

The Mode Register Write command is used to write configuration data to mode registers. The Mode Register Write (MRW) command is initiated by having CS_n LOW, CA0 LOW, CA1 LOW, CA2 LOW, and CA3 LOW at the rising edge of the clock. The mode register is selected by {CA1f-CA0f, CA9r-CA4r}. The data to be written to the mode register is contained in CA9f-CA2f. The MRW command period is defined by tMRW. Mode Register Writes to read-only registers shall have no impact on the functionality of the device.

For LPDDR2-S4 devices, the MRW may only be issued when all banks are in the idle precharge state. One method of ensuring that the banks are in the idle precharge state is to issue a Precharge-All command.

7.4.22.1 Mode Register Write Timing Example: RL = 3, tMRW = 5

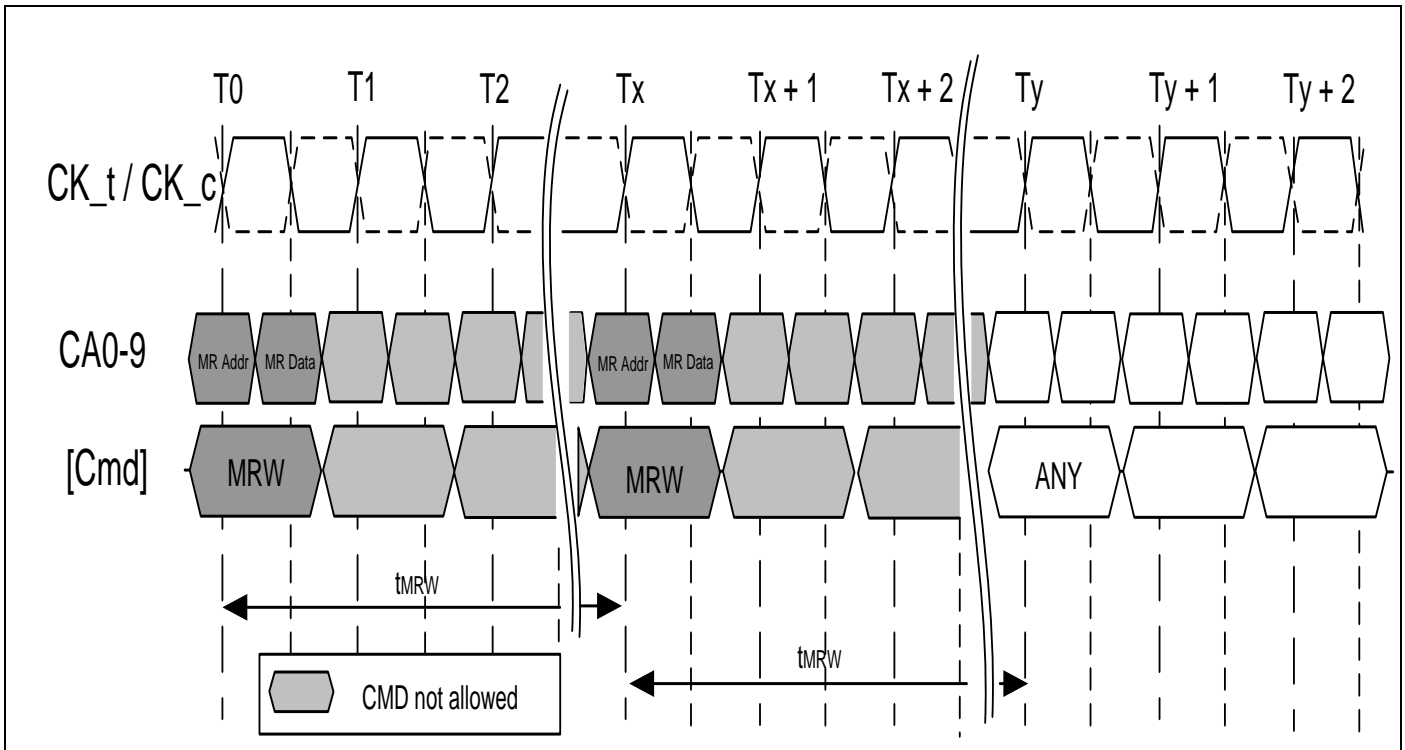

Notes:

1. The Mode Register Write Command period is tMRW. No command (other than Nop) is allowed during this period.
2. At time Ty, the device is in the idle state.

7.4.22.2 Truth Table for Mode Register Read (MRR) and Mode Register Write (MRW)

Current State	Command	Intermediate State	Next State
All Banks Idle	MRR	Mode Register Reading (All Banks Idle)	All Banks Idle
	MRW	Mode Register Writing (All Banks Idle)	All Banks Idle
	MRW (RESET)	Resetting (Device Auto-Initialization)	All Banks Idle
Bank(s) Active	MRR	Mode Register Reading (Bank(s) Active)	Bank(s) Active
	MRW	Not Allowed	Not Allowed
	MRW (RESET)	Not Allowed	Not Allowed



7.4.23 Mode Register Write Reset (MRW Reset)

Any MRW command issued to MRW63 initiates an MRW Reset. The MRW Reset command brings the device to the Device Auto-Initialization (Resetting) State in the Power-On Initialization sequence (see step 3 in sections 7.2.1 “Power Ramp and Device Initialization”). The MRW Reset command may be issued from the Idle state for LPDDR2-S4 devices. This command resets all Mode Registers to their default values. No commands other than NOP may be issued to the LPDDR2 device during the MRW Reset period (tINIT4). After MRW Reset, boot timings must be observed until the device initialization sequence is complete and the device is in the Idle state. Array data for LPDDR2-S4 devices are undefined after the MRW Reset command.

For the timing diagram related to MRW Reset, refer to 7.2.3 “Power Ramp and Initialization Sequence” figure.

7.4.24 Mode Register Write ZQ Calibration Command

The MRW command is also used to initiate the ZQ Calibration command. The ZQ Calibration command is used to calibrate the LPDDR2 output drivers (RON) over process, temperature, and voltage. LPDDR2-S4 devices support ZQ Calibration.

There are four ZQ Calibration commands and related timings times, tzQINIT, tzQRESET, tzQCL, and tzQCS. tzQINIT corresponds to the initialization calibration, tzQRESET for resetting ZQ setting to default, tzQCL is for long calibration, and tzQCS is for short calibration. See Mode Register 10 (MR10) for description on the command codes for the different ZQ Calibration commands.

The Initialization ZQ Calibration (ZQINIT) shall be performed for LPDDR2-S4 devices. This Initialization Calibration achieves a RON accuracy of $\pm 15\%$. After initialization, the ZQ Long Calibration may be used to re-calibrate the system to a RON accuracy of $\pm 15\%$. A ZQ Short Calibration may be used periodically to compensate for temperature and voltage drift in the system.

The ZQReset Command resets the RON calibration to a default accuracy of $\pm 30\%$ across process, voltage, and temperature. This command is used to ensure RON accuracy to $\pm 30\%$ when ZQCS and ZQCL are not used.

One ZQCS command can effectively correct a minimum of 1.5% (ZQCorrection) of RON impedance error within tzQCS for all speed bins assuming the maximum sensitivities specified in the ‘Output Driver Voltage and Temperature Sensitivity’. The appropriate interval between ZQCS commands can be determined from these tables and other application-specific parameters.

One method for calculating the interval between ZQCS commands, given the temperature (Tdriftrate) and voltage (Vdriftrate) drift rates that the LPDDR2 is subject to in the application, is illustrated. The interval could be defined by the following formula:

$$\frac{ZQCorrection}{(TSens \times Tdriftrate) + (VSens \times Vdriftrate)}$$

where TSens = max(dRONdT) and VSens = max(dRONdV) define the LPDDR2 temperature and voltage sensitivities.

For example, if TSens = 0.75% / °C, VSens = 0.20% / mV, Tdriftrate = 1°C / sec and Vdriftrate = 15 mV / sec, then the interval between ZQCS commands is calculated as:

$$\frac{1.5}{(0.75 \times 1) + (0.20 \times 15)} = 0.4s$$

For LPDDR2-S4 devices, a ZQ Calibration command may only be issued when the device is in Idle state with all banks precharged.

No other activities can be performed on the LPDDR2 data bus during the calibration period (tzQINIT, tzQCL, tzQCS). The quiet time on the LPDDR2 data bus helps to accurately calibrate RON. There is no required quiet time after the ZQ Reset command. If multiple devices share a single ZQ Resistor, only one device may be calibrating at any given time. After calibration is achieved, the LPDDR2 device shall disable the ZQ pin’s current consumption path to reduce power.

In systems that share the ZQ resistor between devices, the controller must not allow overlap of tzQINIT, tzQCS, or tzQCL between the devices. ZQ Reset overlap is allowed. If the ZQ resistor is absent from the system, ZQ shall be connected to VDDCA. In this case, the LPDDR2 device shall ignore ZQ calibration commands and the device will use the default calibration settings (See section 8.2.6.5 “RONPU and RONPD Characteristics without ZQ Calibration” Output Driver DC Electrical Characteristics without ZQ Calibration table).



7.4.24.1 ZQ Calibration Initialization Timing Example

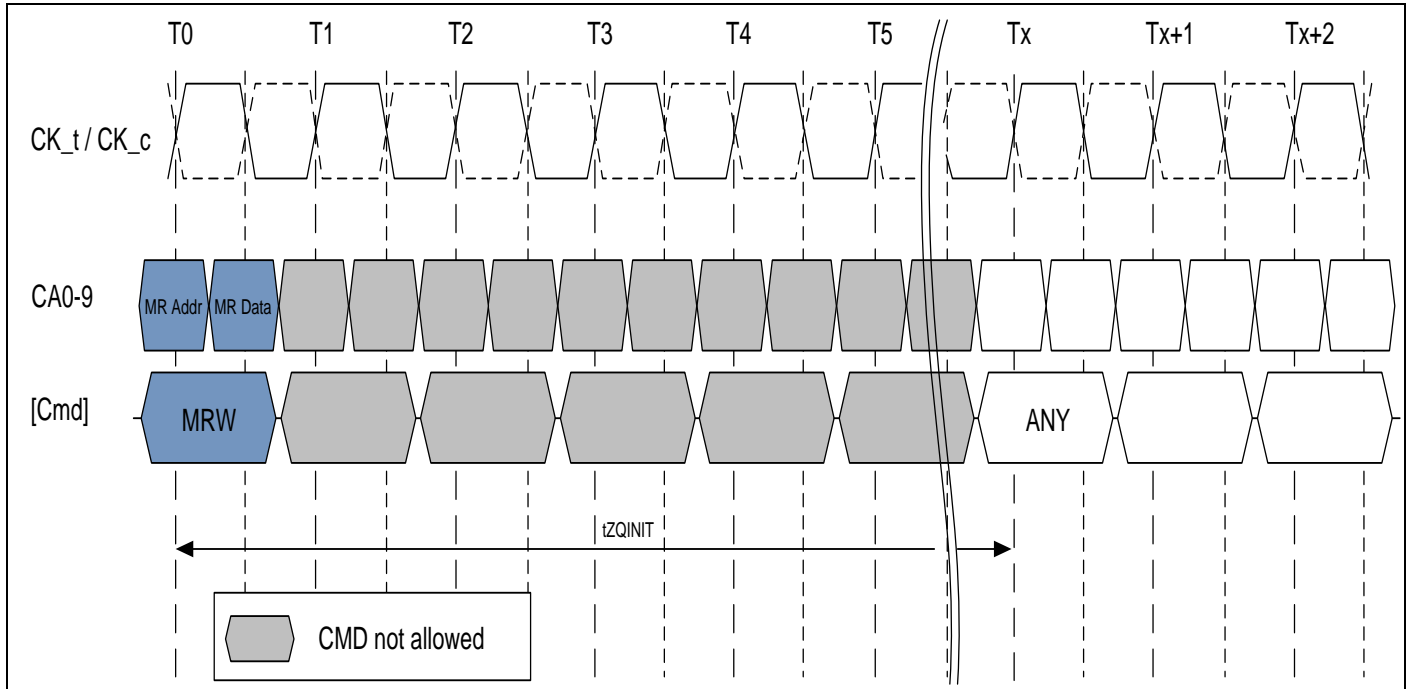

Notes:

1. The ZQ Calibration Initialization period is t_{ZQINIT} . No command (other than Nop) is allowed during this period.
2. CKE must be continuously registered HIGH during the calibration period.
3. All devices connected to the DQ bus should be high impedance during the calibration process.

7.4.24.2 ZQ Calibration Short Timing Example

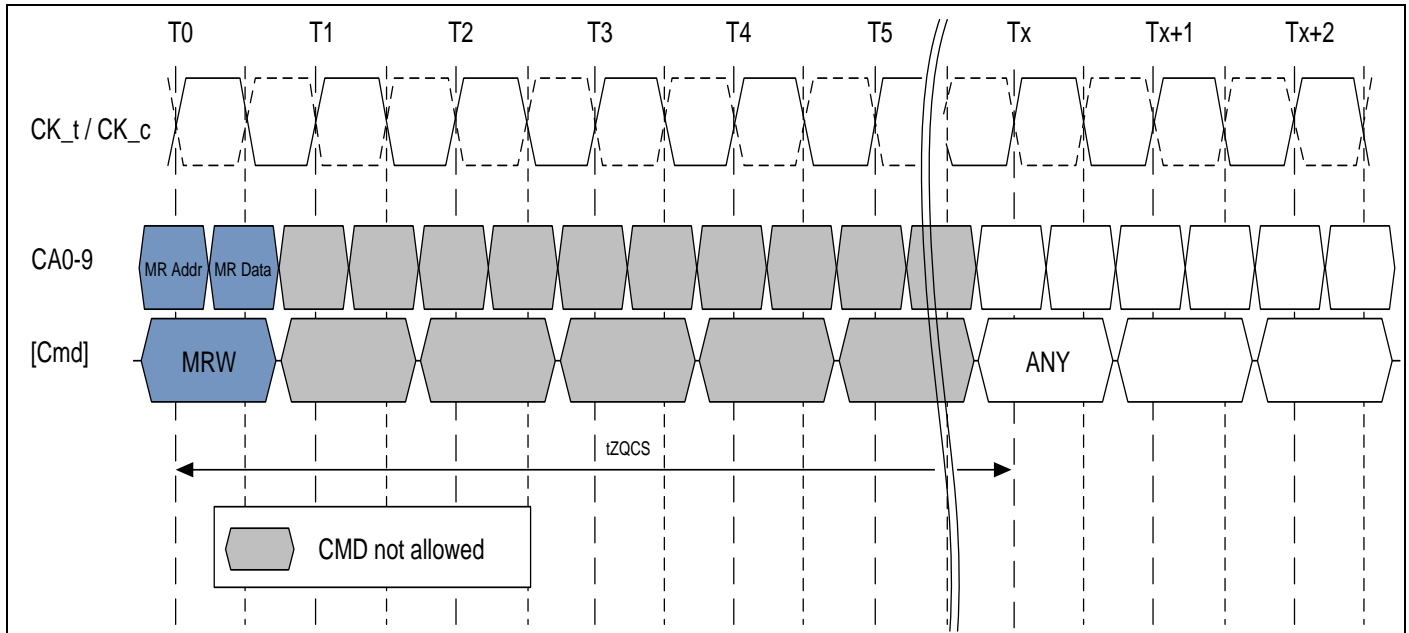

Notes:

1. The ZQ Calibration Short period is t_{ZQCS} . No command (other than Nop) is allowed during this period.
2. CKE must be continuously registered HIGH during the calibration period.
3. All devices connected to the DQ bus should be high impedance during the calibration process.



7.4.24.3 ZQ Calibration Long Timing Example

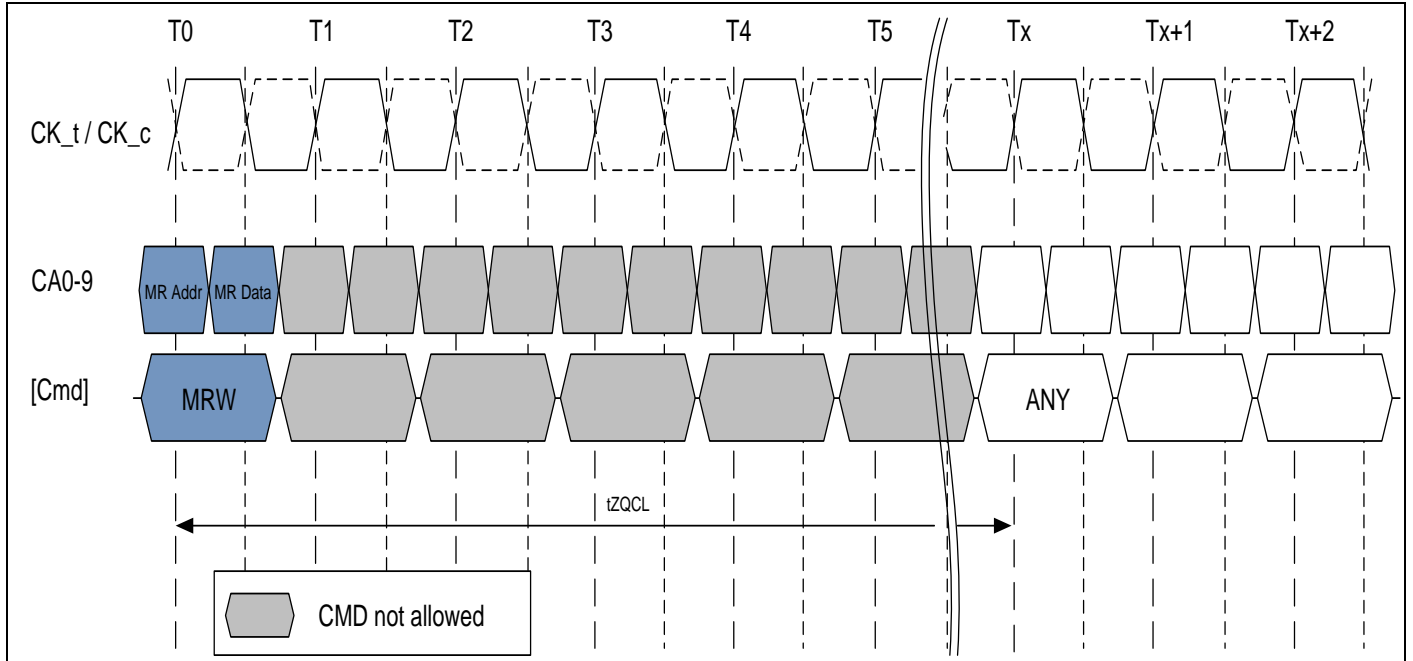

Notes:

1. The ZQ Calibration Long period is tzQCL. No command (other than Nop) is allowed during this period.
2. CKE must be continuously registered HIGH during the calibration period.
3. All devices connected to the DQ bus should be high impedance during the calibration process.

7.4.24.4 ZQ Calibration Reset Timing Example

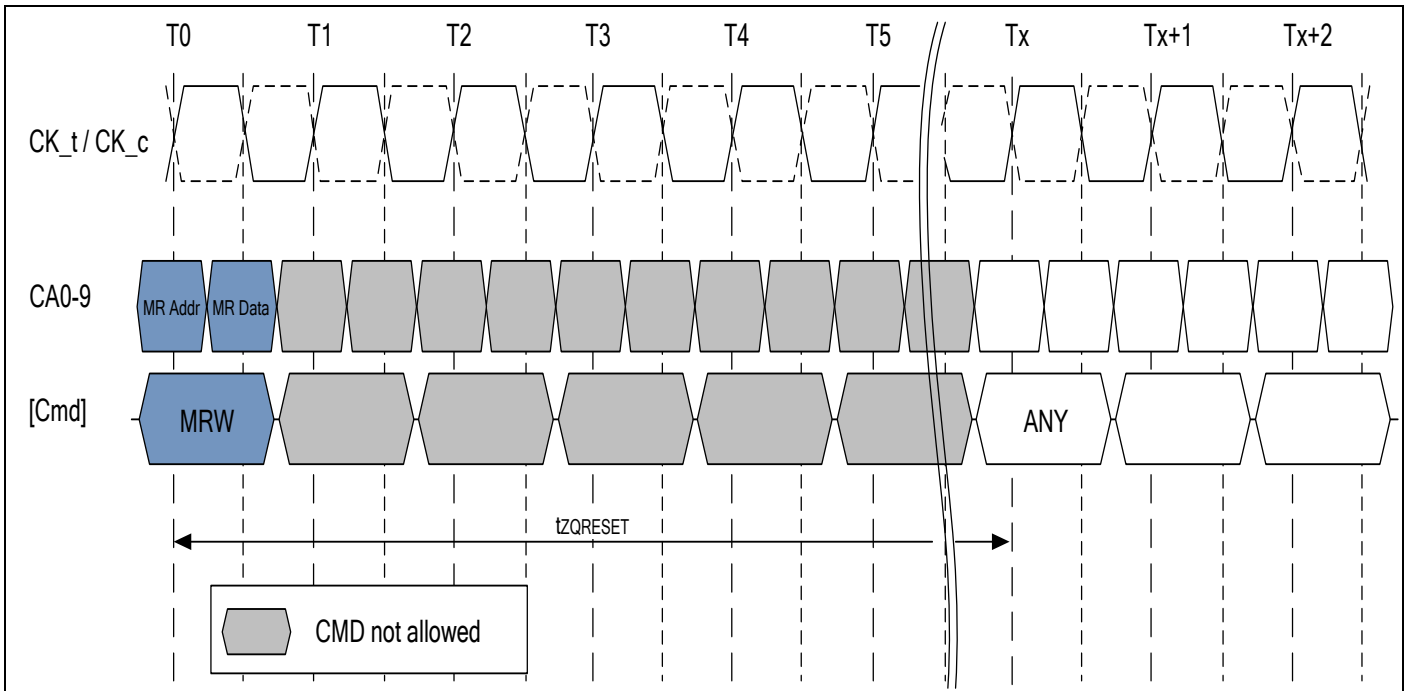

Notes:

1. The ZQ Calibration Reset period is tzQRESET. No command (other than Nop) is allowed during this period.
2. CKE must be continuously registered HIGH during the calibration period.
3. All devices connected to the DQ bus should be high impedance during the calibration process.



7.4.24.5 ZQ External Resistor Value, Tolerance, and Capacitive Loading

To use the ZQ Calibration function, a 240 Ohm \pm 1% tolerance external resistor must be connected between the ZQ pin and ground. A single resistor can be used for each LPDDR2 device or one resistor can be shared between multiple LPDDR2 devices if the ZQ calibration timings for each LPDDR2 device do not overlap. The total capacitive loading on the ZQ pin must be limited (See section 8.2.6.7 “Input/Output Capacitance” table).

7.4.25 Power-Down

For LPDDR2 SDRAM, power-down is synchronously entered when CKE is registered LOW and CS_n HIGH at the rising edge of clock. CKE must be registered HIGH in the previous clock cycle. A NOP command must be driven in the clock cycle following the power-down command. CKE is not allowed to go LOW while mode register, read, or write operations are in progress. CKE is allowed to go LOW while any of other operations such as row activation, preactive, precharge, autoprecharge, or refresh is in progress, but power-down IDD spec will not be applied until finishing those operations. Timing diagrams are shown in the following pages with details for entry into power down.

For LPDDR2 SDRAM, if power-down occurs when all banks are idle, this mode is referred to as idle power-down; if power-down occurs when there is a row active in any bank, this mode is referred to as active power-down.

Entering power-down deactivates the input and output buffers, excluding CK_t, CK_c, and CKE. In power-down mode, CKE must be maintained LOW while all other input signals are “Don’t Care”. CKE LOW must be maintained until t_{CKE} has been satisfied. VREF must be maintained at a valid level during power down.

VDDQ may be turned off during power down. If VDDQ is turned off, then VREFDQ must also be turned off. Prior to exiting power down, both VDDQ and VREFDQ must be within their respective min/max operating ranges (See 8.2.1.1 “Recommended DC Operating Conditions” table).

For LPDDR2 SDRAM, the maximum duration in power-down mode is only limited by the refresh requirements outlined in section 7.4.16 “LPDDR2 SDRAM Refresh Requirements”, as no refresh operations are performed in power-down mode.

The power-down state is exited when CKE is registered HIGH. The controller shall drive CS_n HIGH in conjunction with CKE HIGH when exiting the power-down state. CKE HIGH must be maintained until t_{CKE} has been satisfied. A valid, executable command can be applied with power-down exit latency, t_{XP} after CKE goes HIGH. Power-down exit latency is defined in section 8.7.1 “LPDDR2 AC Timing” table.

7.4.25.1 Basic Power Down Entry and Exit Timing

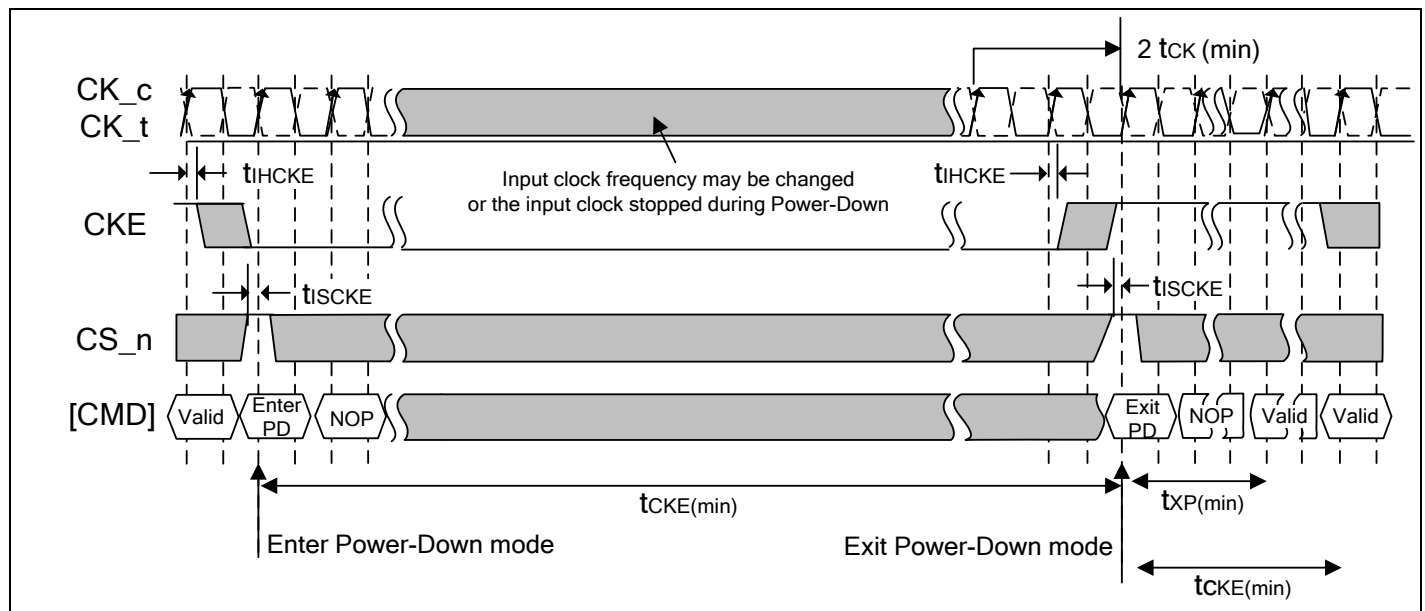

Note:

Input clock frequency may be changed or the input clock stopped during power-down, provided that upon exiting power-down, the clock is stable and within specified limits for a minimum of 2 clock cycles prior to power-down exit and the clock frequency is between the minimum and maximum frequency for the particular speed grade.



7.4.25.2 CKE Intensive Environment

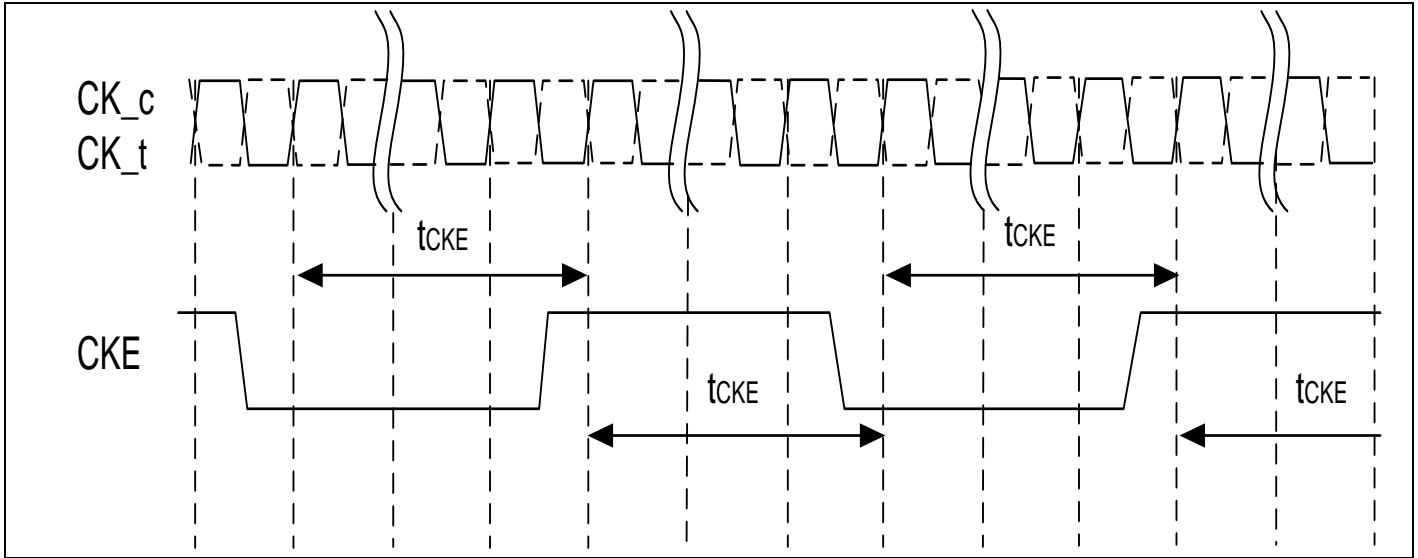

7.4.25.3 Refresh to Refresh Timing with CKE Intensive Environment

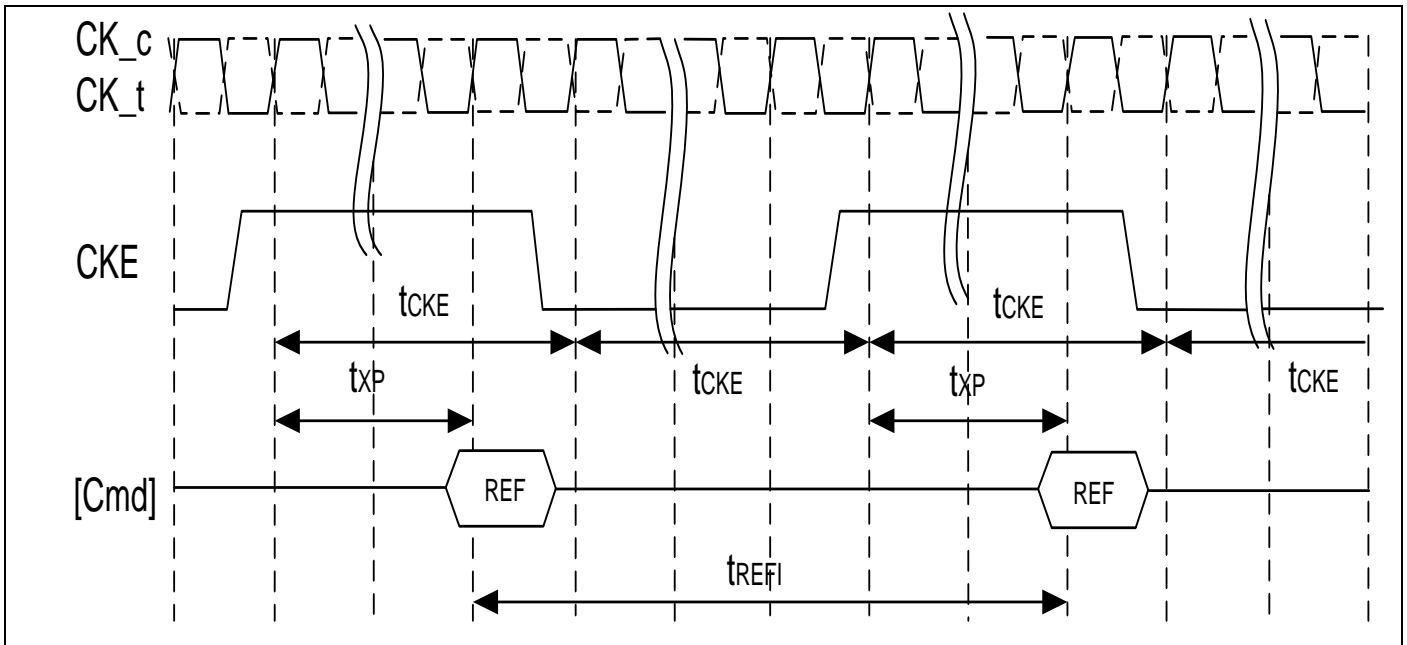

Note:

The pattern shown above can repeat over a long period of time. With this pattern, LPDDR2 SDRAM guarantees all AC and DC timing & voltage specifications with temperature and voltage drift.



7.4.25.4 Read to Power-Down Entry

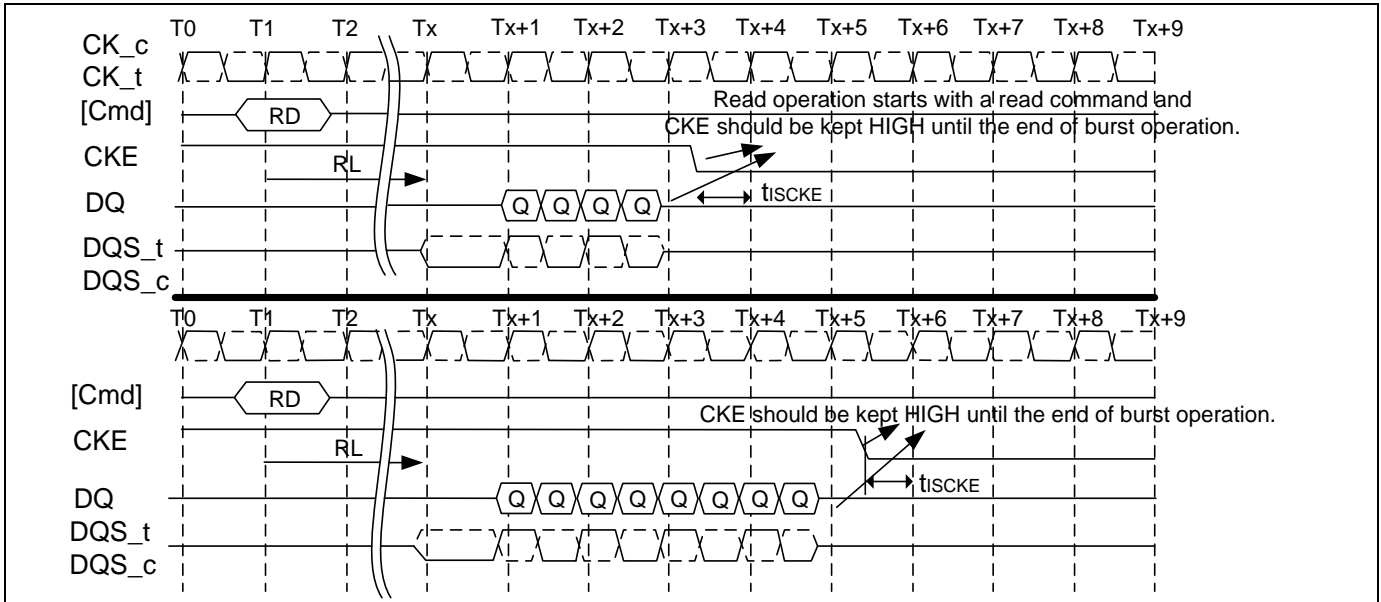

Note:

CKE may be registered LOW $RL + RU(tdQSCK(MAX)/tCK) + BL/2 + 1$ clock cycles after the clock on which the Read command is Registered.

7.4.25.5 Read with Auto Precharge to Power-Down Entry

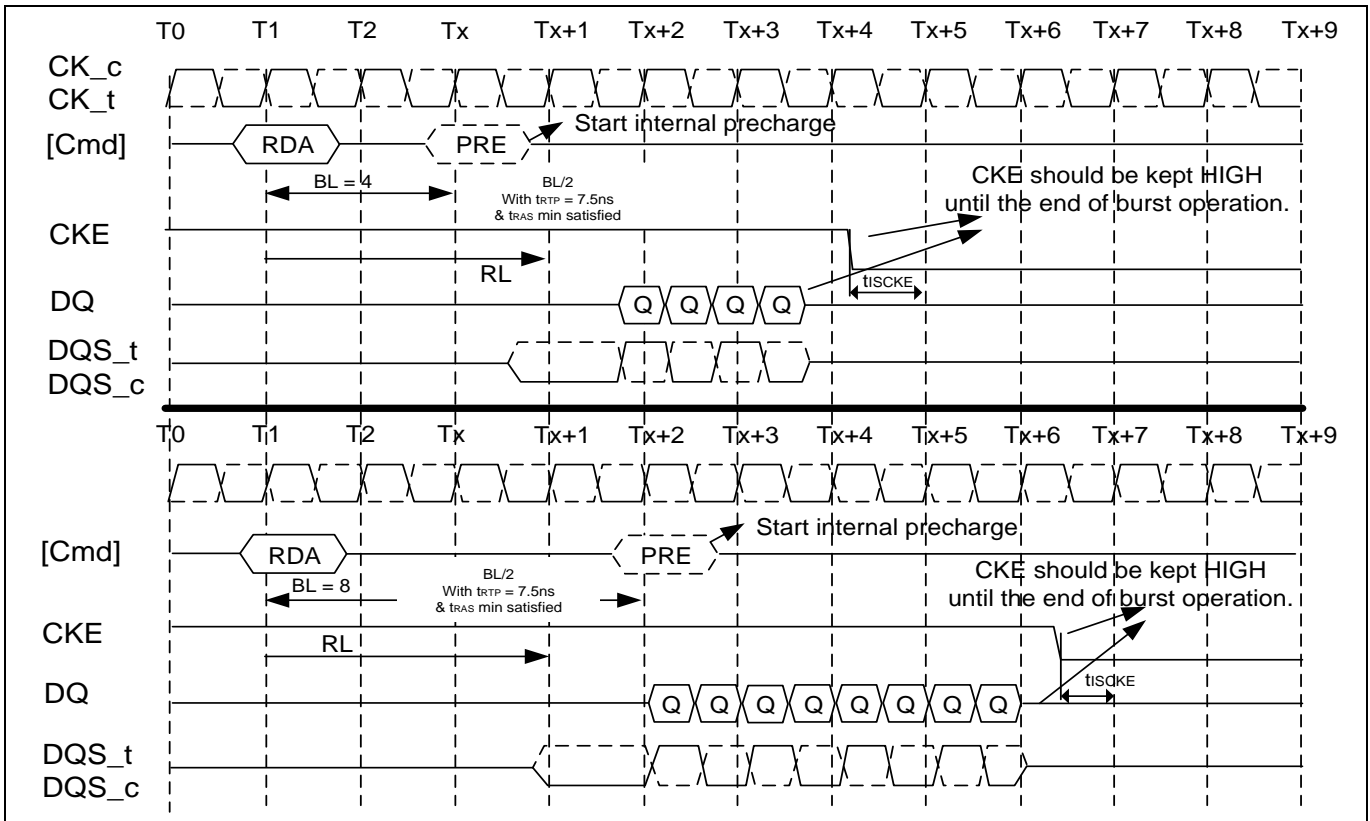

Note:

CKE may be registered LOW $RL + RU(tdQSCK(MAX)/tCK) + BL/2 + 1$ clock cycles after the clock on which the Read command is registered.



7.4.25.6 Write to Power-Down Entry

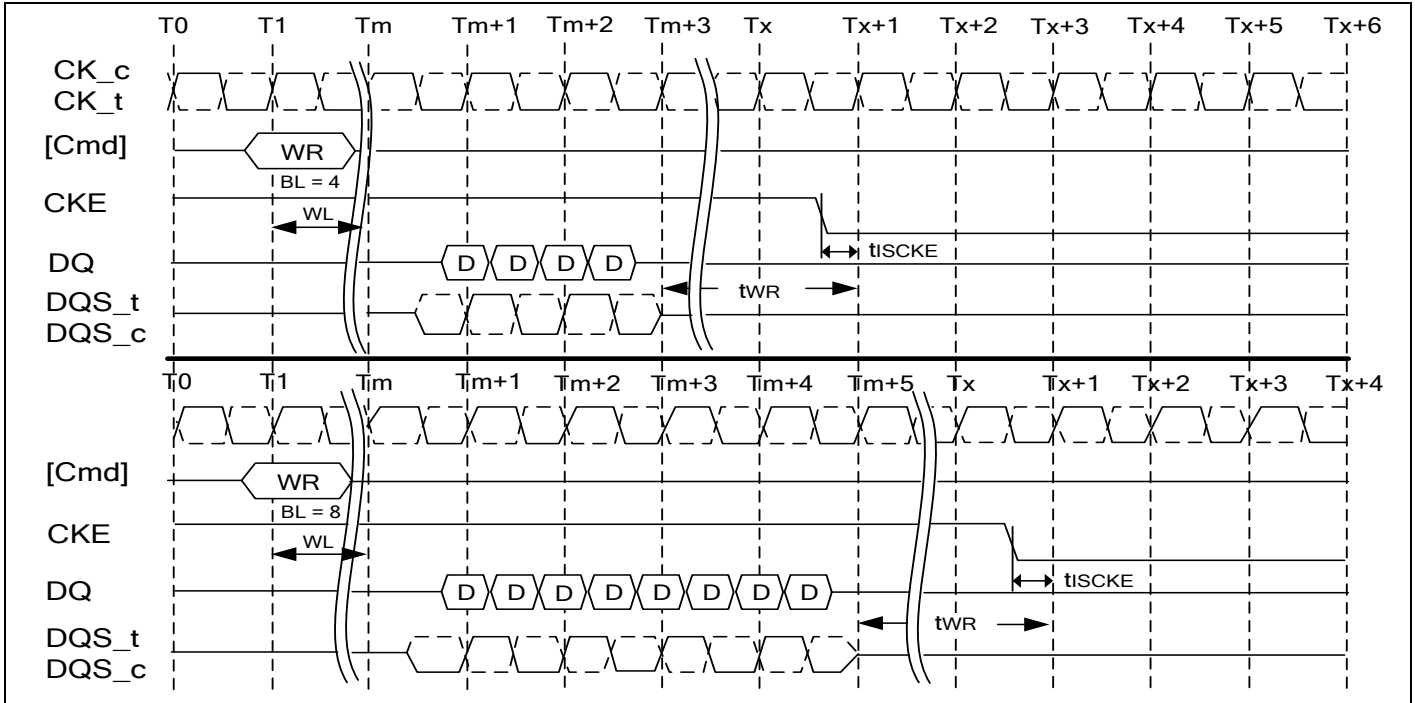

Note:

CKE may be registered LOW $WL + 1 + BL/2 + RU(tWR/tCK)$ clock cycles after the clock on which the Write command is registered.

7.4.25.7 Write with Auto Precharge to Power-Down Entry

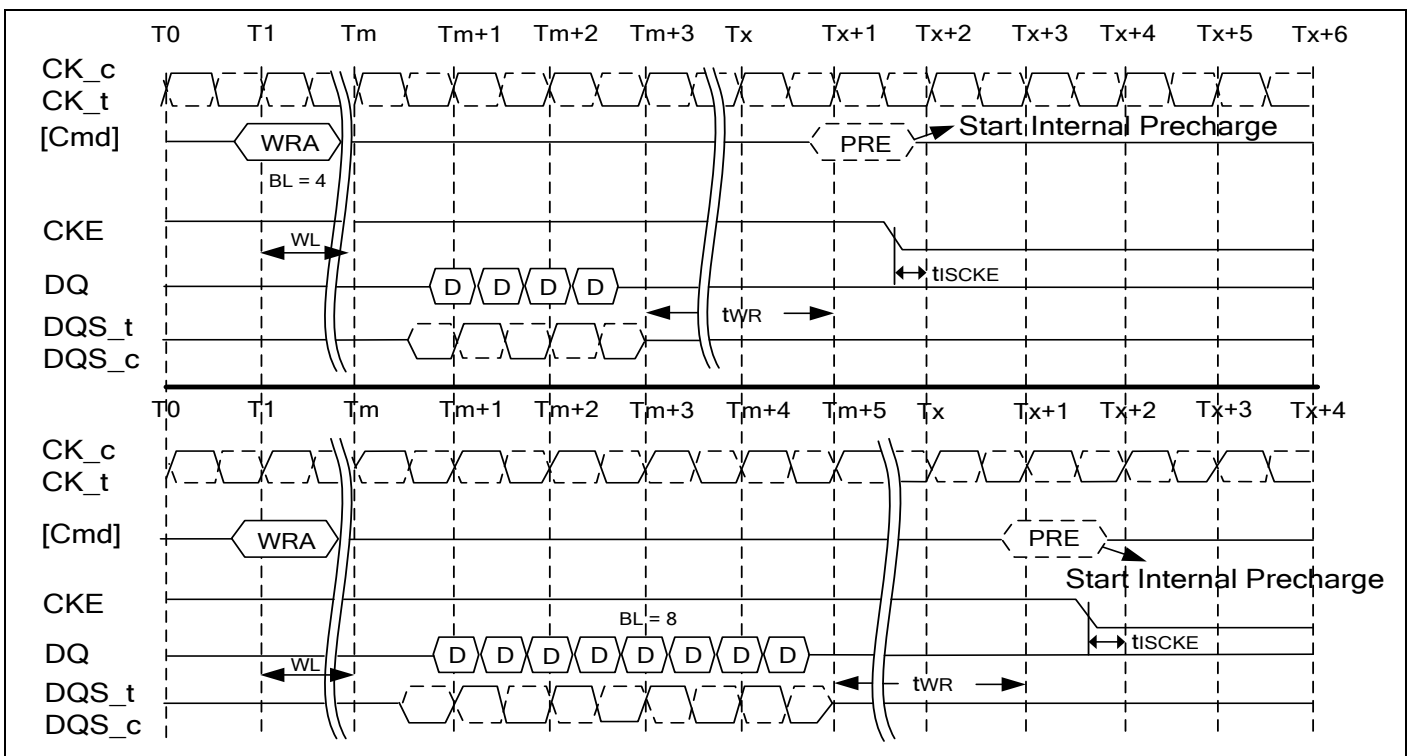

Note:

CKE may be registered LOW $WL + 1 + BL/2 + RU(tWR/tCK) + 1$ clock cycles after the Write command is registered.



7.4.25.8 Refresh Command to Power-Down Entry

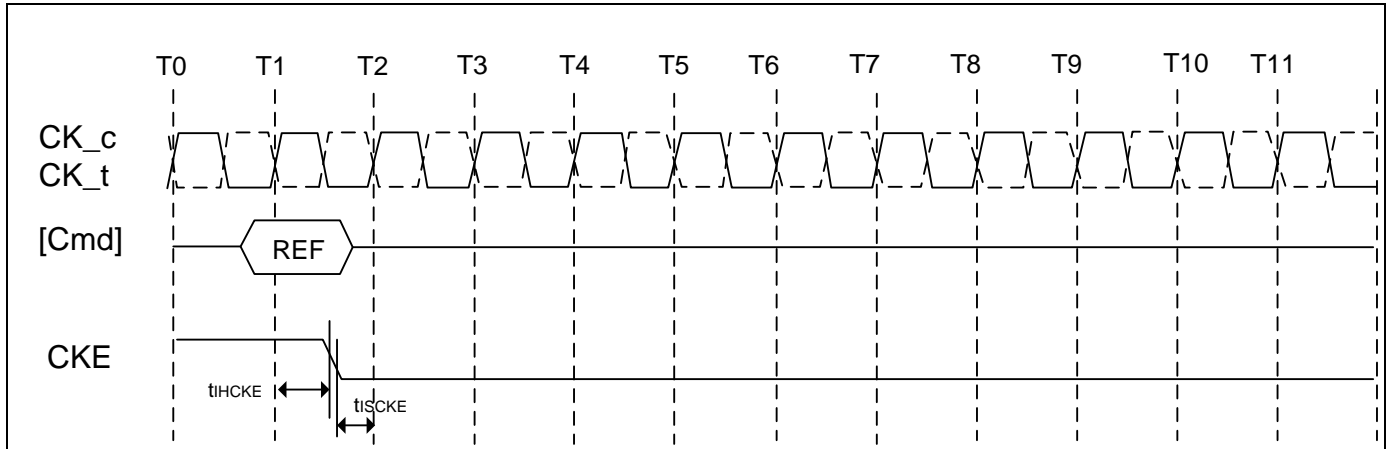

Note:
CKE may go LOW t_{IHCKE} after the clock on which the Refresh command is registered.

7.4.25.9 Activate Command to Power-Down Entry

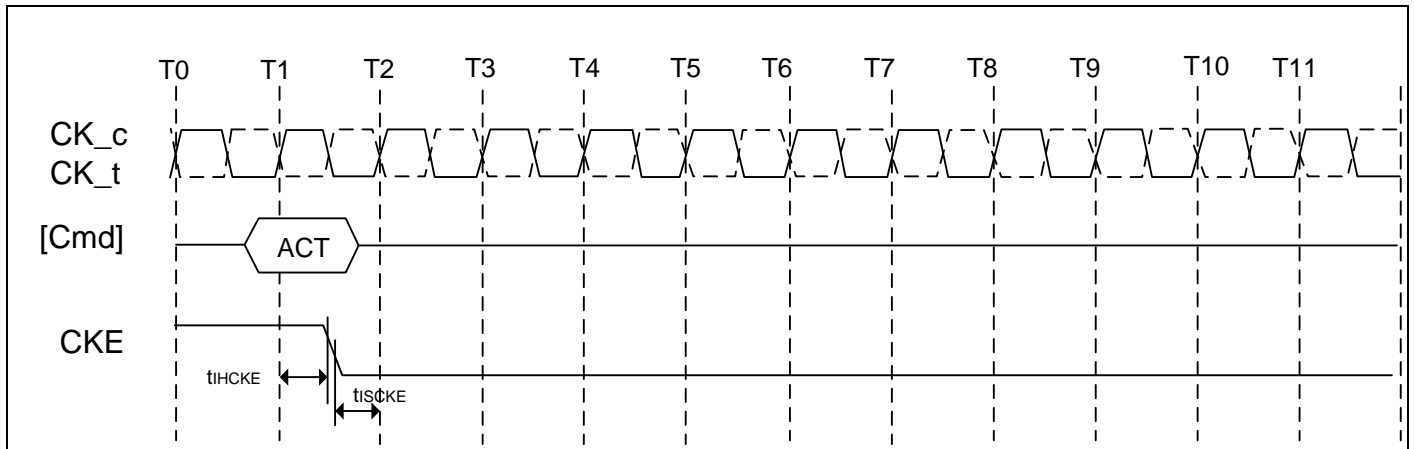

Note:
CKE may go LOW t_{IHCKE} after the clock on which the Activate command is registered.

7.4.25.10 Precharge/Precharge-All Command to Power-Down Entry

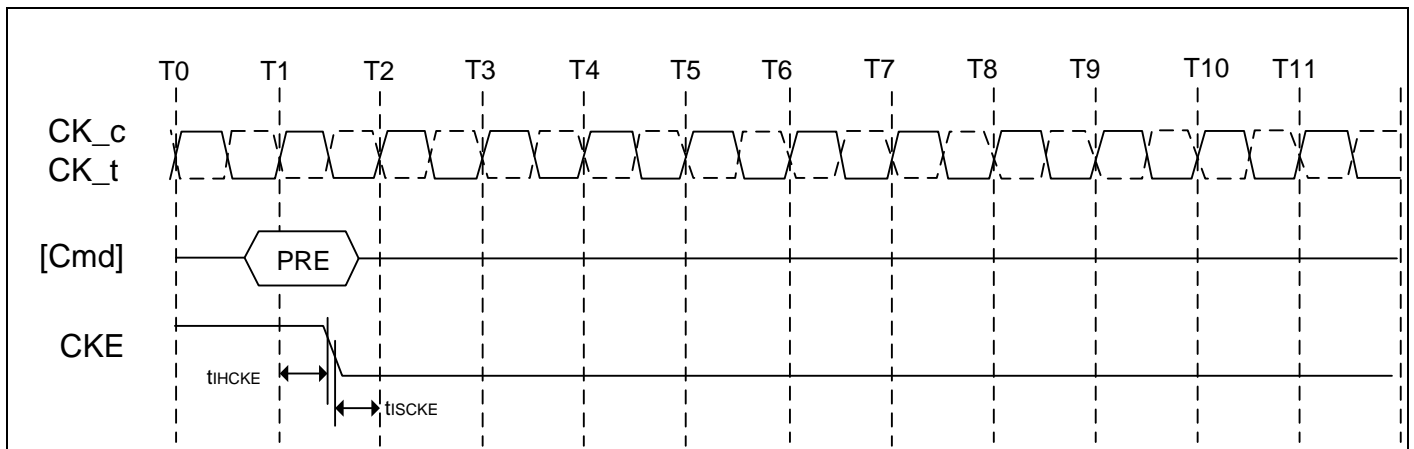

Note:
CKE may go LOW t_{IHCKE} after the clock on which the Precharge/Precharge-All command is registered.



7.4.25.11 Mode Register Read to Power-Down Entry

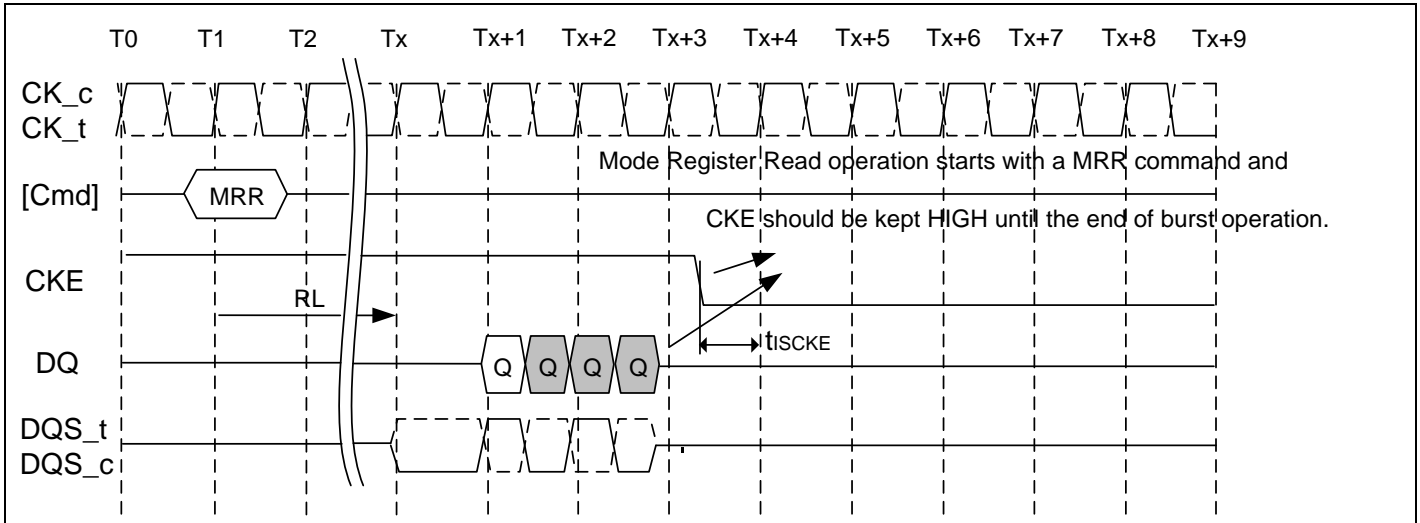

Note:

CKE may be registered LOW $RL + RU(tDQSK(MAX)/tCK) + BL/2 + 1$ clock cycles after the clock on which the Mode Register Read command is registered.

7.4.25.12 MRW Command to Power-Down Entry

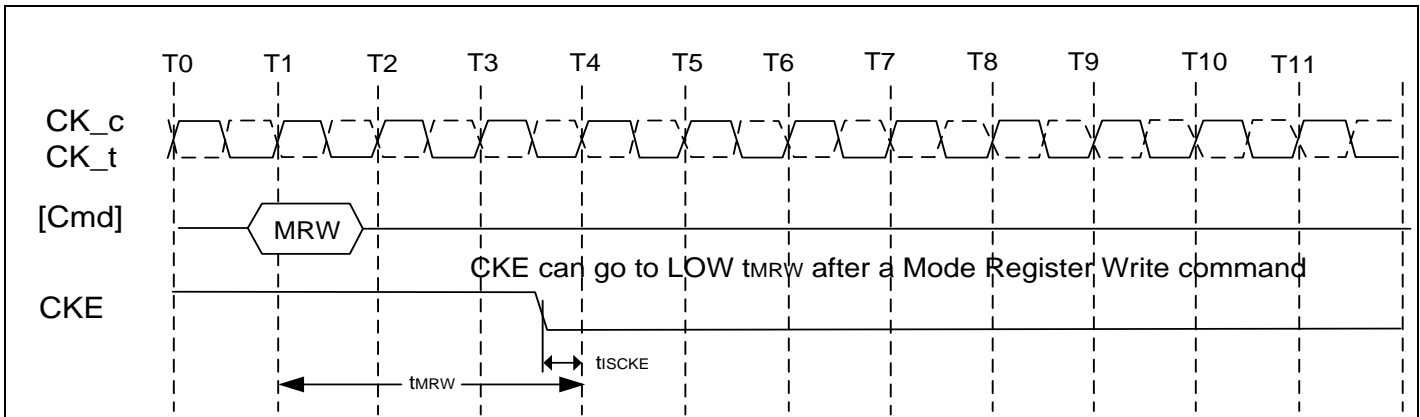

Note:

CKE may be registered LOW $tMRW$ after the clock on which the Mode Register Write command is registered.

7.4.26 Deep Power-Down

Deep Power-Down is entered when CKE is registered LOW with CS_n LOW, CA0 HIGH, CA1 HIGH, and CA2 LOW at the rising edge of clock. A NOP command must be driven in the clock cycle following the power-down command. CKE is not allowed to go LOW while mode register, read, or write operations are in progress. All banks must be in idle state with no activity on the data bus prior to entering the Deep Power Down mode. During Deep Power-Down, CKE must be held LOW.

In Deep Power-Down mode, all input buffers except CKE, all output buffers, and the power supply to internal circuitry may be disabled within the SDRAM. All power supplies must be within specified limits prior to exiting Deep Power-Down. V_{refDQ} and V_{refCA} may be at any level within minimum and maximum levels (See 8.1 “**Absolute Maximum DC Ratings**”). However prior to exiting Deep Power-Down, V_{ref} must be within specified limits (See 8.2.1.1 “**Recommended DC Operating Conditions**”).



The contents of the SDRAM may be lost upon entry into Deep Power-Down mode.

The Deep Power-Down state is exited when CKE and CS_n are registered HIGH, while meeting tISCKE with a stable clock input. The SDRAM must be fully re-initialized by controller as described in the Power up initialization Sequence. The SDRAM is ready for normal operation after the initialization sequence.

7.4.26.1 Deep Power Down Entry and Exit Timing

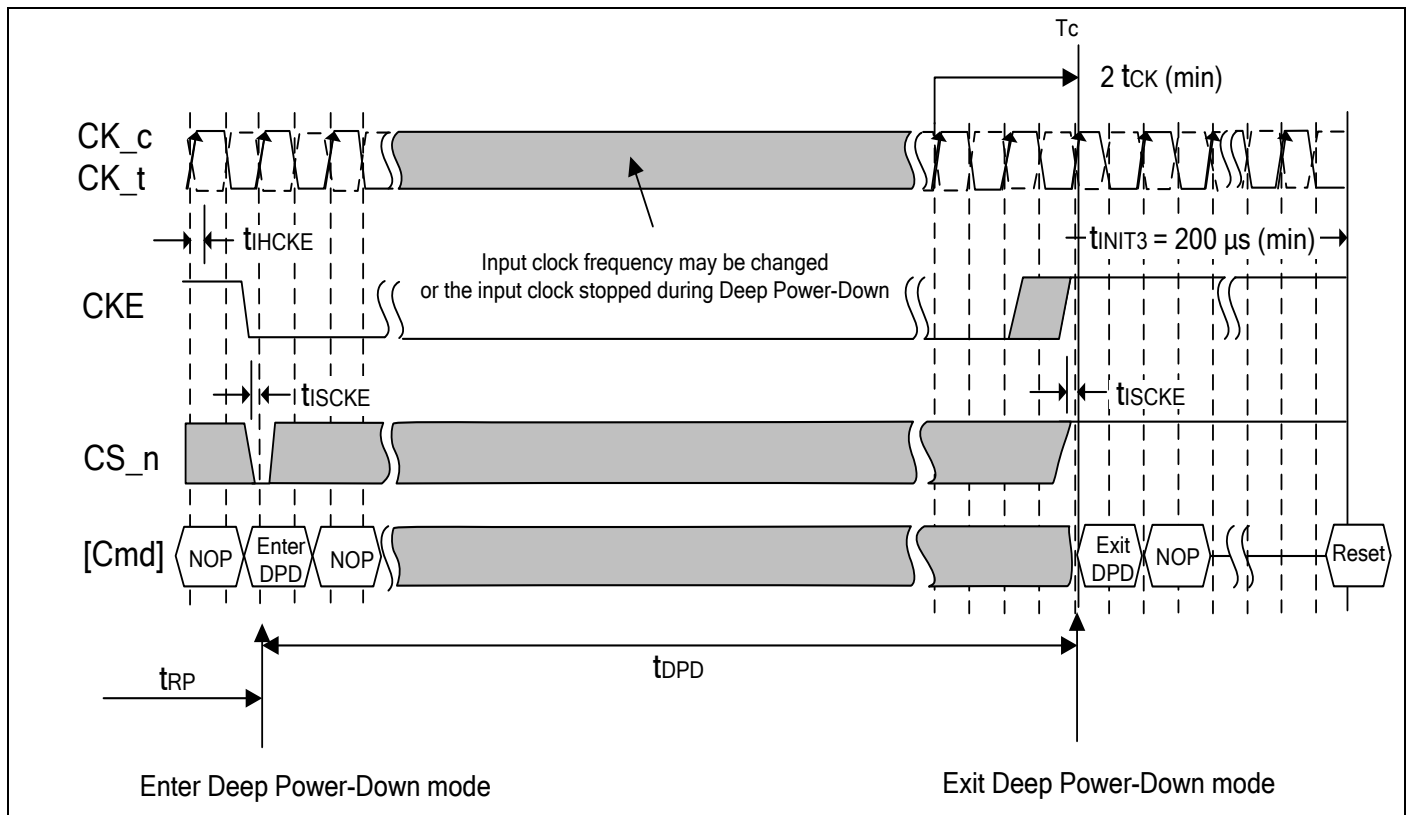

Notes:

1. Initialization sequence may start at any time after Tc.
2. tINIT3 and Tc refer to timings in the LPDDR2 initialization sequence. For more detail, see section 7.2 "Power-up, Initialization, and Power-Off".
3. Input clock frequency may be changed or the input clock stopped during deep power-down, provided that upon exiting deep power-down, the clock is stable and within specified limits for a minimum of 2 clock cycles prior to deep power-down exit and the clock frequency is between the minimum and maximum frequency for the particular speed grade.

7.4.27 Input Clock Stop and Frequency Change

LPDDR2 devices support input clock frequency change during CKE LOW under the following conditions:

- tCK(abs)min is met for each clock cycle;
- Refresh Requirements apply during clock frequency change;
- During clock frequency change, only REFab or REFpb commands may be executing;
- Any Activate, or Precharge commands have executed to completion prior to changing the frequency;
- The related timing conditions (tRCD, tRP) have been met prior to changing the frequency;
- The initial clock frequency shall be maintained for a minimum of 2 clock cycles after CKE goes LOW;
- The clock satisfies tCH(abs) and tCL(abs) for a minimum of 2 clock cycles prior to CKE going HIGH.

After the input clock frequency is changed and CKE is held HIGH, additional MRW commands may be required to set the WR, RL etc. These settings may need to be adjusted to meet minimum timing requirements at the target clock frequency.



LPDDR2 devices support clock stop during CKE LOW under the following conditions:

- CK_t is held LOW and CK_c is held HIGH during clock stop;
- Refresh Requirements apply during clock stop;
- During clock stop, only REFab or REFpb commands may be executing;
- Any Activate, or Precharge commands have executed to completion prior to stopping the clock;
- The related timing conditions (TRCD, TRP) have been met prior to stopping the clock;
- The initial clock frequency shall be maintained for a minimum of 2 clock cycles after CKE goes LOW;
- The clock satisfies t_{CH(abs)} and t_{CL(abs)} for a minimum of 2 clock cycles prior to CKE going HIGH.

LPDDR2 devices support input clock frequency change during CKE HIGH under the following conditions:

- t_{CK(abs)min} is met for each clock cycle;
- Refresh Requirements apply during clock frequency change;
- Any Activate, Read, Write, Precharge, Mode Register Write, or Mode Register Read commands must have executed to completion, including any associated data bursts prior to changing the frequency;
- The related timing conditions (TRCD, t_{WR}, t_{WRA}, t_{RP}, t_{MRW}, t_{MRR}, etc.) have been met prior to changing the frequency;
- CS_n shall be held HIGH during clock frequency change;
- During clock frequency change, only REFab or REFpb commands may be executing;
- The LPDDR2 device is ready for normal operation after the clock satisfies t_{CH(abs)} and t_{CL(abs)} for a minimum of 2t_{CK} + t_{XP}.

After the input clock frequency is changed, additional MRW commands may be required to set the WR, RL etc. These settings may need to be adjusted to meet minimum timing requirements at the target clock frequency.

LPDDR2 devices support clock stop during CKE HIGH under the following conditions:

- CK_t is held LOW and CK_c is held HIGH during clock stop;
- CS_n shall be held HIGH during clock stop;
- Refresh Requirements apply during clock stop;
- During clock stop, only REFab or REFpb commands may be executing;
- Any Activate, Read, Write, Precharge, Mode Register Write, or Mode Register Read commands must have executed to completion, including any associated data bursts prior to stopping the clock;
- The related timing conditions (TRCD, t_{WR}, t_{WRA}, t_{RP}, t_{MRW}, t_{MRR}, etc.) have been met prior to stopping the clock;
- The LPDDR2 device is ready for normal operation after the clock is restarted and satisfies t_{CH(abs)} and t_{CL(abs)} for a minimum of 2t_{CK} + t_{XP}.

7.4.28 No Operation Command

The purpose of the No Operation command (NOP) is to prevent the LPDDR2 device from registering any unwanted command between operations. Only when the CKE level is constant for clock cycle N-1 and clock cycle N, a NOP command may be issued at clock cycle N. A NOP command has two possible encodings:

1. CS_n HIGH at the clock rising edge N.
2. CS_n LOW and CA0, CA1, CA2 HIGH at the clock rising edge N.

The No Operation command will not terminate a previous operation that is still executing, such as a burst read or write cycle.

7.5 Truth Tables

The truth tables provide complementary information to the state diagram, they clarify the device behavior and the applied restrictions when considering the actual state of all the Banks.

Operation or timing that is not specified is illegal, and after such an event, in order to guarantee proper operation, the LPDDR2 device must be powered down and then restarted through the specified initialization sequence before normal operation can continue.



7.5.1 Command Truth Table

Command	Command Pins			DDR CA Pins (10)										CK_t EDGE
	CKE		CS_N	CA0	CA1	CA2	CA3	CA4	CA5	CA6	CA7	CA8	CA9	
	CK_t(n-1)	CK_t(n)												
MRW	H	H	L	L	L	L	L	MA0	MA1	MA2	MA3	MA4	MA5	
			X	MA6	MA7	OP0	OP1	OP2	OP3	OP4	OP5	OP6	OP7	
MRR	H	H	L	L	L	L	H	MA0	MA1	MA2	MA3	MA4	MA5	
			X	MA6	MA7	X								
Refresh (per bank) ¹¹	H	H	L	L	L	H	L	X						
			X	X										
Refresh (all bank)	H	H	L	L	L	H	H	X						
			X	X										
Enter Self Refresh	H	L	L	L	L	H	X							
	X		X	X										
Activate (bank)	H	H	L	L	H	R8	R9	R10	R11	R12	BA0	BA1	BA2	
			X	R0	R1	R2	R3	R4	R5	R6	R7	R13	R14	
Write (bank)	H	H	L	H	L	L	RFU	RFU	C1	C2	BA0	BA1	BA2	
			X	AP ^{3,4}	C3	C4	C5	C6	C7	C8	C9	C10	C11	
Read (bank)	H	H	L	H	L	H	RFU	RFU	C1	C2	BA0	BA1	BA2	
			X	AP ^{3,4}	C3	C4	C5	C6	C7	C8	C8	C10	C11	
Precharge (per bank, all bank)	H	H	L	H	H	L	H	AB ^{*13}	X	X	BA0	BA1	BA2	
			X	X										
BST	H	H	L	H	H	L	L	X						
			X	X										
Enter Deep Power Down	H	L	L	H	H	L	X							
	X		X	X										
NOP	H	H	L	H	H	H	X							
			X	X										
Maintain PD,SREF,DPD (NOP)	L	L	L	H	H	H	X							
			X	X										
NOP	H	H	H	X										
			X	X										
Maintain PD,SREF,DPD (NOP)	L	L	H	X										
			X	X										
Enter Power Down	H	L	H	X										
	X		X	X										
Exit PD, SREF,DPD	L	H	H	X										
	X		X	X										

**Notes:**

1. All LPDDR2 commands are defined by states of CS_n, CA0, CA1, CA2, CA3, and CKE at the rising edge of the clock.
2. For LPDDR2 SDRAM, Bank addresses BA0, BA1, BA2 (BA) determine which bank is to be operated upon.
3. AP is significant only to SDRAM.
4. AP "high" during a READ or WRITE command indicates that an auto-precharge will occur to the bank associated with the READ or WRITE command.
5. "X" means "H or L (but a defined logic level)".
6. Self refresh exit and Deep Power Down exit are asynchronous.
7. VREF must be between 0 and VDDQ during Self Refresh and Deep Power Down operation.
8. CAx refers to command/address bit "x" on the rising edge of clock.
9. CAxf refers to command/address bit "x" on the falling edge of clock.
10. CS_n and CKE are sampled at the rising edge of clock.
11. Per Bank Refresh is only allowed in devices with 8 banks.
12. The least-significant column address C0 is not transmitted on the CA bus, and is implied to be zero.
13. AB "high" during Precharge command indicates that all bank Precharge will occur. In this case, Bank Address is do-not-care.

7.5.2 CKE Truth Table

Device Current State ³	CKEn-1 ¹	CKEn ¹	CS_n ²	Command n ⁴	Operation n ⁴	Device Next State	Notes
Active Power Down	L	L	X	X	Maintain Active Power Down	Active Power Down	
	L	H	H	NOP	Exit Active Power Down	Active	6, 9
Idle Power Down	L	L	X	X	Maintain Idle Power Down	Idle Power Down	
	L	H	H	NOP	Exit Idle Power Down	Idle	6, 9
Resetting Power Down	L	L	X	X	Maintain Resetting Power Down	Resetting Power Down	
	L	H	H	NOP	Exit Resetting Power Down	Idle or Resetting	6, 9, 12
Deep Power Down	L	L	X	X	Maintain Deep Power Down	Deep Power Down	
	L	H	H	NOP	Exit Deep Power Down	Power On	8
Self Refresh	L	L	X	X	Maintain Self Refresh	Self Refresh	
	L	H	H	NOP	Exit Self Refresh	Idle	7, 10
Bank(s) Active	H	L	H	NOP	Enter Active Power Down	Active Power Down	
All Banks Idle	H	L	H	NOP	Enter Idle Power Down	Idle Power Dow	
	H	L	L	Enter Self Refresh	Enter Self Refresh	Self Refresh	
	H	L	L	Deep Power Down	Enter Deep Power Down	Deep Power Down	
Resetting	H	L	H	NOP	Enter Resetting Power Down	Resetting Power Down	
Others states	H	H	Refer to the Command Truth Table				

Notes:

1. "CKEn" is the logic state of CKE at clock rising edge n; "CKEn-1" was the state of CKE at the previous clock edge.
2. "CS_n" is the logic state of CS_n at the clock rising edge n;
3. "Current state" is the state of the LPDDR2 device immediately prior to clock edge n.
4. "Command n" is the command registered at clock edge N, and "Operation n" is a result of "Command n".
5. All states and sequences not shown are illegal or reserved unless explicitly described elsewhere in this document.
6. Power Down exit time (tXP) should elapse before a command other than NOP is issued.
7. Self-Refresh exit time (tXSR) should elapse before a command other than NOP is issued.
8. The Deep Power-Down exit procedure must be followed as discussed in the Deep Power-Down section of the Functional Description.
9. The clock must toggle at least once during the tXP period.
10. The clock must toggle at least once during the tXSR time.
11. X' means 'Don't care'.
12. Upon exiting Resetting Power Down, the device will return to the Idle state if tINIT5 has expired.



7.5.3 Current State Bank n - Command to Bank n Truth Table

Current State	Command	Operation	Next State	Notes
Any	NOP	Continue previous operation	Current State	
Idle	ACTIVATE	Select and activate row	Active	
	Refresh (Per Bank)	Begin to refresh	Refreshing(Per Bank)	6
	Refresh (All Bank)	Begin to refresh	Refreshing(All Bank)	7
	MRW	Load value to Mode Register	MR Writing	7
	MRR	Read value from Mode Register	Idle MR Reading	
	Reset	Begin Device Auto-Initialization	Resetting	7, 8
	Precharge	Deactivate row in bank or banks	Precharging	9, 15
Row Active	Read	Select column, and start read burst	Reading	
	Write	Select column, and start write burst	Writing	
	MRR	Read value from Mode Register	Active MR Reading	
	Precharge	Deactivate row in bank or banks	Precharging	9
Reading	Read	Select column, and start new read burst	Reading	10, 11
	Write	Select column, and start write burst	Writing	10, 11, 12
	BST	Read burst terminate	Active	13
Writing	Write	Select column, and start new write burst	Writing	10, 11
	Read	Select column, and start read burst	Reading	10, 11, 14
	BST	Write burst terminate	Active	13
Power On	Reset	Begin Device Auto-Initialization	Resetting	7, 9
Resetting	MRR	Read value from Mode Register	Resetting MR Reading	

Notes:

- The table applies when both CKEn-1 and CKEn are HIGH, and after tXSR or tXP has been met if the previous state was Power Down.
- All states and sequences not shown are illegal or reserved.
- Current State Definitions:
 - Idle: The bank or banks have been precharged, and tRP has been met.
 - Active: A row in the bank has been activated, and tRCD has been met. No data bursts / accesses and no register accesses are in progress.
 - Reading: A Read burst has been initiated, with Auto Precharge disabled, and has not yet terminated or been terminated.
 - Writing: A Write burst has been initiated, with Auto Precharge disabled, and has not yet terminated or been terminated.
- The following states must not be interrupted by a command issued to the same bank. NOP commands or allowable commands to the other bank should be issued on any clock edge occurring during these states. Allowable commands to the other banks are determined by its current state and 7.5.3 "Current State Bank n - Command to Bank n Truth Table", and according to 7.5.4 "Current State Bank n - Command to Bank m Truth Table".
 - Precharging: starts with the registration of a Precharge command and ends when tRP is met. Once tRP is met, the bank will be in the idle state.
 - Row Activating: starts with registration of an Activate command and ends when tRCD is met. Once tRCD is met, the bank will be in the 'Active' state.
 - Read with AP Enabled: starts with the registration of the Read command with Auto Precharge enabled and ends when tRP has been met. Once tRP has been met, the bank will be in the idle state.
 - Write with AP Enabled: starts with registration of a Write command with Auto Precharge enabled and ends when tRP has been met. Once tRP is met, the bank will be in the idle state.



5. The following states must not be interrupted by any executable command; NOP commands must be applied to each positive clock edge during these states.
 - Refreshing (Per Bank): starts with registration of a Refresh (Per Bank) command and ends when tRFCpb is met. Once tRFCpb is met, the bank will be in an 'idle' state.
 - Refreshing (All Bank): starts with registration of a Refresh (All Bank) command and ends when tRFCab is met. Once tRFCab is met, the device will be in an 'all banks idle' state.
 - Idle MR Reading: starts with the registration of a MRR command and ends when tMRR has been met. Once tMRR has been met, the bank will be in the Idle state.
 - Resetting MR Reading: starts with the registration of a MRR command and ends when tMRR has been met. Once tMRR has been met, the bank will be in the Resetting state.
 - Active MR Reading: starts with the registration of a MRR command and ends when tMRR has been met. Once tMRR has been met, the bank will be in the Active state.
 - MR Writing: starts with the registration of a MRW command and ends when tMRW has been met. Once tMRW has been met, the bank will be in the Idle state.
 - Precharging All: starts with the registration of a Precharge-All command and ends when tRP is met. Once tRP is met, the bank will be in the idle state.
6. Bank-specific; requires that the bank is idle and no bursts are in progress.
7. Not bank-specific; requires that all banks are idle and no bursts are in progress.
8. Not bank-specific reset command is achieved through Mode Register Write command.
9. This command may or may not be bank specific. If all banks are being precharged, they must be in a valid state for pre- charging.
10. A command other than NOP should not be issued to the same bank while a Read or Write burst with Auto Precharge is enabled.
11. The new Read or Write command could be Auto Precharge enabled or Auto Precharge disabled.
12. A Write command may be applied after the completion of the Read burst; otherwise, a BST must be used to end the Read prior to asserting a Write command.
13. Not bank-specific. Burst Terminate (BST) command affects the most recent read/write burst started by the most recent Read/Write command, regardless of bank.
14. A Read command may be applied after the completion of the Write burst; otherwise, a BST must be used to end the Write prior to asserting a Read command.
15. If a Precharge command is issued to a bank in the Idle state, tRP shall still apply.



7.5.4 Current State Bank n - Command to Bank m Truth Table

Current State of Bank n	Command for Bank m	Operation	Next State for Bank m	Notes
Any	NOP	Continue previous operation	Current State of Bank m	
Idle	Any	Any command allowed to Bank m	-	18
Row Activating, Active, or Precharging	Activate	Select and activate row in Bank m	Active	7
	Read	Select column, and start read burst from Bank m	Reading	8
	Write	Select column, and start write burst to Bank m	Writing	8
	Precharge	Deactivate row in bank or banks	Precharging	9
	MRR	Read value from Mode Register	Idle MR Reading or Active MR Reading	10, 11, 13
	BST	Read or Write burst terminate an ongoing Read/Write from/to Bank m	Active	18
Reading (Autoprecharge disabled)	Read	Select column, and start read burst from Bank m	Reading	8
	Write	Select column, and start write burst to Bank m	Writing	8, 14
	Activate	Select and activate row in Bank m	Active	
	Precharge	Deactivate row in bank or banks	Precharging	9
Writing (Autoprecharge disabled)	Read	Select column, and start read burst from Bank m	Reading	8, 16
	Write	Select column, and start write burst to Bank m	Writing	8
	Activate	Select and activate row in Bank m	Active	
	Precharge	Deactivate row in bank or banks	Precharging	9
Reading with Autoprecharge	Read	Select column, and start read burst from Bank m	Reading	8, 15
	Write	Select column, and start write burst to Bank m	Writing	8, 14, 15
	Activate	Select and activate row in Bank m	Active	
	Precharge	Deactivate row in bank or banks	Precharging	9
Writing with Autoprecharge	Read	Select column, and start read burst from Bank m	Reading	8, 15, 16
	Write	Select column, and start write burst to Bank m	Writing	8, 15
	Activate	Select and activate row in Bank m	Active	
	Precharge	Deactivate row in bank or banks	Precharging	9
Power On	Reset	Begin Device Auto-Initialization	Resetting	12, 17
Resetting	MRR	Read value from Mode Register	Resetting MR Reading	

Notes:

- The table applies when both CKEn-1 and CKEn are HIGH, and after tXSR or tXP has been met if the previous state was Self Refresh or Power Down.
- All states and sequences not shown are illegal or reserved.
- Current State Definitions:
 Idle: the bank has been precharged, and tRP has been met.
 Active: a row in the bank has been activated, and tRCD has been met. No data bursts/accesses and no register accesses are in progress.
 Reading: a Read burst has been initiated, with Auto Precharge disabled, and has not yet terminated or been terminated.
 Writing: a Write burst has been initiated, with Auto Precharge disabled, and has not yet terminated or been terminated.



4. Refresh, Self-Refresh, and Mode Register Write commands may only be issued when all bank are idle.
5. A Burst Terminate (BST) command cannot be issued to another bank; it applies to the bank represented by the current state only.
6. The following states must not be interrupted by any executable command; NOP commands must be applied during each clock cycle while in these states:
 - Idle MR Reading: starts with the registration of a MRR command and ends when tMRR has been met. Once tMRR has been met, the bank will be in the Idle state.
 - Resetting MR Reading: starts with the registration of a MRR command and ends when tMRR has been met. Once tMRR has been met, the bank will be in the Resetting state.
 - Active MR Reading: starts with the registration of a MRR command and ends when tMRR has been met. Once tMRR has been met, the bank will be in the Active state.
 - MR Writing: starts with the registration of a MRW command and ends when tMRW has been met. Once tMRW has been met, the bank will be in the Idle state.
7. tRRD must be met between Activate command to Bank n and a subsequent Activate command to Bank m.
8. Reads or Writes listed in the Command column include Reads and Writes with Auto Precharge enabled and Reads and Writes with Auto Precharge disabled.
9. This command may or may not be bank specific. If all banks are being precharged, they must be in a valid state for pre- charging.
10. MRR is allowed during the Row Activating state (Row Activating starts with registration of an Activate command and ends when tRCD is met).
11. MRR is allowed during the Precharging state. (Precharging starts with registration of a Precharge command and ends when tRP is met).
12. Not bank-specific; requires that all banks are idle and no bursts are in progress.
13. The next state for Bank m depends on the current state of Bank m (Idle, Row Activating, Precharging, or Active). The reader shall note that the state may be in transition when a MRR is issued. Therefore, if Bank m is in the Row Activating state and Precharging, the next state may be Active and Precharge dependent upon tRCD and tRP respectively.
14. A Write command may be applied after the completion of the Read burst; otherwise a BST must be issued to end the Read prior to asserting a Write command.
15. Read with auto precharge enabled or a Write with auto precharge enabled may be followed by any valid command to other banks provided that the timing restrictions in 7.4.14.2 "**Precharge & Auto Precharge Clarification**" table are followed.
16. A Read command may be applied after the completion of the Write burst; otherwise, a BST must be issued to end the Write prior to asserting a Read command.
17. Reset command is achieved through Mode Register Write command.
18. BST is allowed only if a Read or Write burst is ongoing.

7.5.5 Data Mask Truth Table

Name (Functional)	DM	DQs	Note
Write enable	L	Valid	1
Write inhibit	H	X	1

Note:

1. Used to mask write data, provided coincident with the corresponding data.



8. ELECTRICAL CHARACTERISTIC

8.1 Absolute Maximum DC Ratings

Stresses greater than those listed may cause permanent damage to the device. This is a stress rating only, and functional operation of the device at these or any other conditions above those indicated in the operational sections of this specification is not implied. Exposure to absolute maximum rating conditions for extended periods may affect reliability.

Parameter	Symbol	Min	Max	Units	Notes
VDD1 supply voltage relative to VSS	VDD1	-0.4	+2.3	V	2
VDD2 supply voltage relative to VSS	VDD2	-0.4	+1.6	V	2
VDDCA supply voltage relative to VSSCA	VDDCA	-0.4	+1.6	V	2, 4
VDDQ supply voltage relative to VSSQ	VDDQ	-0.4	+1.6	V	2, 3
Voltage on any ball relative to VSS	V _{IN} , V _{OUT}	-0.4	+1.6	V	
Storage Temperature	T _{STG}	-55	+125	°C	5

Notes:

1. Stresses greater than those listed under “Absolute Maximum Ratings” may cause permanent damage to the device. This is a stress rating only and functional operation of the device at these or any other conditions above those indicated in the operational sections of this specification is not implied. Exposure to absolute maximum rating conditions for extended periods may affect reliability.
2. See “Power Ramp” in section 7.2.1 “**Power Ramp and Device Initialization**” for relationships between power supplies.
3. VREFDQ ≤ 0.6 x VDDQ; however, VREFDQ may be ≥ VDDQ provided that VREFDQ ≤ 300mV.
4. VREFCA ≤ 0.6 x VDDCA; however, VREFCA may be ≥ VDDCA provided that VREFCA ≤ 300mV.
5. Storage Temperature is the case surface temperature on the center/top side of the LPDDR2 device. For the measurement conditions, please refer to JESD51-2 standard.

8.2 AC & DC Operating Conditions

Operation or timing that is not specified is illegal, and after such an event, in order to guarantee proper operation, the LPDDR2 Device must be powered down and then restarted through the specialized initialization sequence before normal operation can continue.

8.2.1 Recommended DC Operating Conditions

8.2.1.1 Recommended DC Operating Conditions

Symbol	LPDDR2-S4B			DRAM	Unit
	Min	Typ	Max		
VDD1	1.70	1.80	1.95	Core Power1	V
VDD2	1.14	1.20	1.30	Core Power2	V
VDDCA	1.14	1.20	1.30	Input Buffer Power	V
VDDQ	1.14	1.20	1.30	I/O Buffer Power	V

Note: VDD1 uses significantly less power than VDD2.



8.2.2 Input Leakage Current

Parameter/Condition	Symbol	Min	Max	Unit	Notes
Input Leakage current For CA, CE, CS_n, CK_t, CK_c Any input $0V \leq V_{IN} \leq V_{DDCA}$ (All other pins not under test = 0V)	IL	-2	2	μA	2
VREF supply leakage current $V_{REFDQ} = V_{DDQ}/2$ or $V_{REFCA} = V_{DDCA}/2$ (All other pins not under test = 0V)	IVREF	-1	1	μA	1

Notes:

- The minimum limit requirement is for testing purposes. The leakage current on VREFCA and VREFDQ pins should be minimal.
- Although DM is for input only, the DM leakage shall match the DQ and DQS_t/DQS_c output leakage specification.

8.2.3 Operating Temperature Conditions

Parameter/Condition	Symbol	Min	Max	Unit
Standard	TOPER	-40	85	$^{\circ}C$
Extended		85	105	$^{\circ}C$

Notes:

- Operating Temperature is the case surface temperature on the center/top side of the LPDDR2 device. For the measurement conditions, please refer to JESD51-2 standard.
- Some applications require operation of LPDDR2 in the maximum temperature conditions in the Extended Temperature Range between 85 $^{\circ}C$ and 105 $^{\circ}C$ case temperature. For LPDDR2 devices, some derating is necessary to operate in this range. See the MR4 Device Temperature (MA[7:0] = 04h) table.
- Either the device operating temperature or the temperature sensor (See section 7.4.21 "Temperature Sensor") may be used to set an appropriate refresh rate, determine the need for AC timing derating and/or monitor the operating temperature. When using the temperature sensor, the actual device case temperature may be higher than the TOPER rating that applies for the Standard or Extended Temperature Ranges. For example, TCASE may be above 85 $^{\circ}C$ when the temperature sensor indicates a temperature of less than 85 $^{\circ}C$.
- All parts list in section 3 ordering information table will not guarantee to meet AC specification in the range of extended temperature range.

8.2.4 AC and DC Input Measurement Levels

8.2.4.1 AC and DC Logic Input Levels for Single-Ended Signals

8.2.4.1.1 Single-Ended AC and DC Input Levels for CA and CS_n Inputs

Symbol	Parameter	LPDDR2-800		Unit	Notes
		Min	Max		
$V_{IHCA}(AC)$	AC input logic high	$V_{ref} + 0.220$	Note 2	V	1, 2
$V_{ILCA}(AC)$	AC input logic low	Note 2	$V_{ref} - 0.220$	V	1, 2
$V_{IHCA}(DC)$	DC input logic high	$V_{ref} + 0.130$	VDDCA	V	1
$V_{ILCA}(DC)$	DC input logic low	VSSCA	$V_{ref} - 0.130$	V	1
$V_{RefCA}(DC)$	Reference Voltage for CA and CS_n inputs	$0.49 * V_{DDCA}$	$0.51 * V_{DDCA}$	V	3, 4

Notes:

- For CA and CS_n input only pins. $V_{ref} = V_{refCA}(DC)$.
- See section 8.2.5.5 "Overshoot and Undershoot Specifications".
- The ac peak noise on VRefCA may not allow VRefCA to deviate from VRefCA(DC) by more than $\pm 1\%$ VDDCA (for reference: approx. ± 12 mV).
- For reference: approx. $V_{DDCA}/2 \pm 12$ mV.



8.2.4.1.2 Single-Ended AC and DC Input Levels for CKE

Symbol	Parameter	Min	Max	Unit	Note
V _{IHCKE}	CKE Input High Level	0.8 * VDDCA	Note 1	V	1
V _{ILCKE}	CKE Input Low Level	Note 1	0.2 * VDDCA	V	1

Note 1: See section 8.2.5.5 “Overshoot and Undershoot Specifications”.

8.2.4.1.3 Single-Ended AC and DC Input Levels for DQ and DM

Symbol	Parameter	LPDDR2-800		Unit	Notes
		Min	Max		
V _{IHDQ(AC)}	AC input logic high	V _{ref} + 0.220	Note 2	V	1, 2
V _{ILDQ(AC)}	AC input logic low	Note 2	V _{ref} - 0.220	V	1, 2
V _{IHDQ(DC)}	DC input logic high	V _{ref} + 0.130	VDDQ	V	1
V _{ILDQ(DC)}	DC input logic low	VSSQ	V _{ref} - 0.130	V	1
V _{RefDQ(DC)}	Reference Voltage for DQ, DM inputs	0.49 * VDDQ	0.51 * VDDQ	V	3, 4

Notes:

- For DQ input only pins. V_{ref} = V_{refDQ(DC)}.
- See section 8.2.5.5 “Overshoot and Undershoot Specifications”.
- The ac peak noise on V_{refDQ} may not allow V_{refDQ} to deviate from V_{refDQ(DC)} by more than ± 1% VDDQ (for reference: approx. ±12 mV).
- For reference: approx. VDDQ/2 ± 12 mV.

8.2.4.2 V_{ref} Tolerances

The DC tolerance limits and ac-noise limits for the reference voltages V_{refCA} and V_{refDQ} are illustrated in below “**V_{ref(DC)} Tolerance and V_{ref AC-Noise Limits}” figure. It shows a valid reference voltage V_{ref(t)} as a function of time. (V_{ref} stands for V_{refCA} and V_{refDQ} likewise). VDD stands for VDDCA for V_{refCA} and VDDQ for V_{refDQ}. V_{ref(DC)} is the linear average of V_{ref(t)} over a very long period of time (e.g. 1 sec) and is specified as a fraction of the linear average of VDDQ or VDDCA also over a very long period of time (e.g. 1 sec). This average has to meet the min/max requirements in 8.2.4.1.1 “**Single-Ended AC and DC Input Levels for CA and CS_n Inputs**” table. Furthermore V_{ref(t)} may temporarily deviate from V_{ref(DC)} by no more than ± 1% VDD. V_{ref(t)} cannot track noise on VDDQ or VDDCA if this would send V_{ref} outside these specifications.**



8.2.4.2.1 V_{Ref}(DC) Tolerance and V_{Ref} AC-Noise Limits

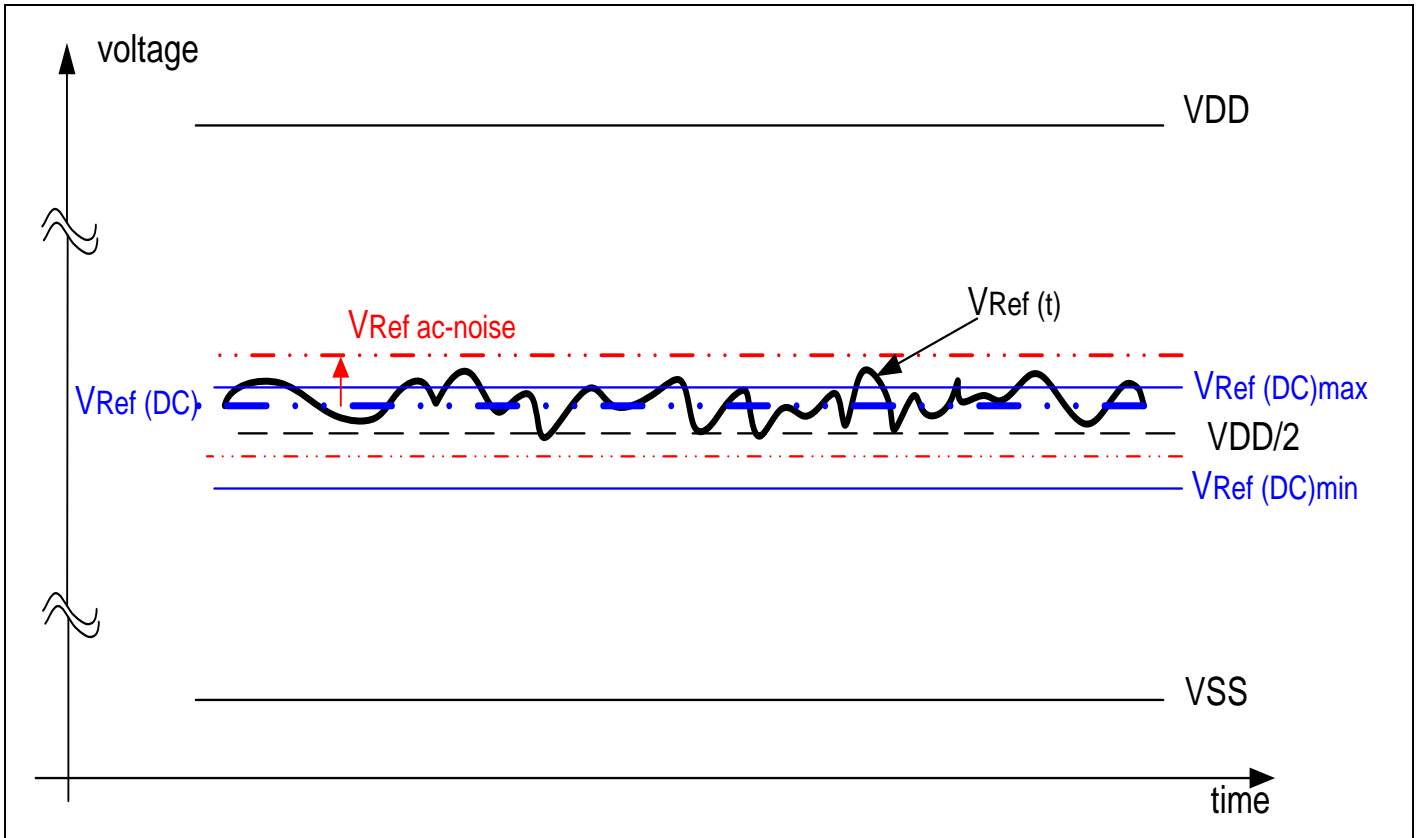

The voltage levels for setup and hold time measurements $V_{IH(AC)}$, $V_{IH(DC)}$, $V_{IL(AC)}$ and $V_{IL(DC)}$ are dependent on V_{Ref} .

“ V_{Ref} ” shall be understood as $V_{Ref(DC)}$, as defined in above “**V_{Ref}(DC) Tolerance and V_{Ref} AC-Noise Limits**” figure.

This clarifies that dc-variations of V_{Ref} affect the absolute voltage a signal has to reach to achieve a valid high or low level and therefore the time to which setup and hold is measured. Devices will function correctly with appropriate timing deratings with V_{REF} outside these specified levels so long as V_{REF} is maintained between $0.44 \times V_{DDQ}$ (or V_{DDCA}) and $0.56 \times V_{DDQ}$ (or V_{DDCA}) and so long as the controller achieves the required single-ended AC and DC input levels from instantaneous V_{Ref} (see 8.2.4.1.1 “**Single-Ended AC and DC Input Levels for CA and CS_n Inputs**” table and 8.2.4.1.3 “**Single-Ended AC and DC Input Levels for DQ and DM**” table) Therefore, system timing and voltage budgets need to account for V_{REF} deviations outside of this range.

This also clarifies that the LPDDR2 setup/hold specification and derating values need to include time and voltage associated with V_{Ref} ac-noise. Timing and voltage effects due to ac-noise on V_{Ref} up to the specified limit ($\pm 1\%$ of VDD) are included in LPDDR2 timings and their associated deratings.



8.2.4.3 Input Signal

8.2.4.3.1 LPDDR2-800 Input Signal

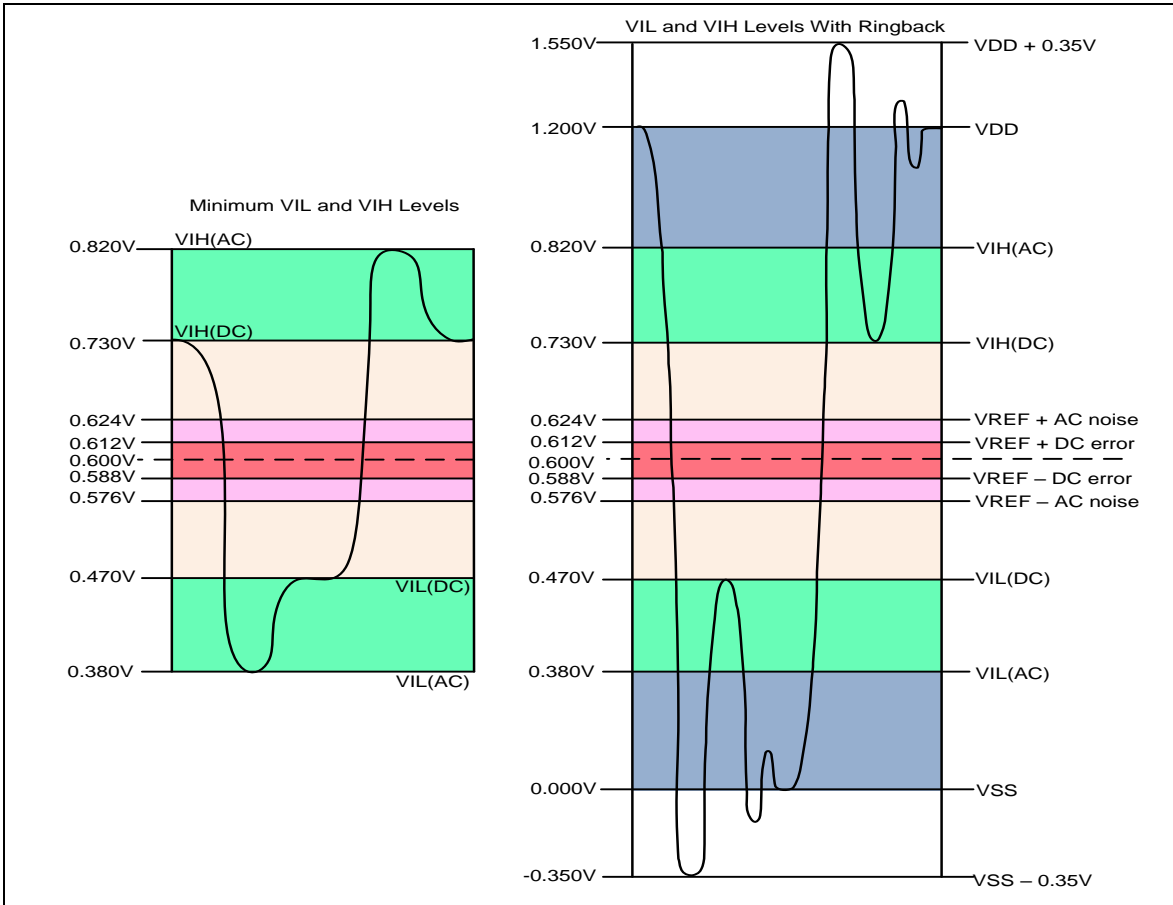

Notes:

1. Numbers reflect nominal values.
2. For CA0-9, CK_t, CK_c, and CS_n, VDD stands for VDDCA. For DQ, DM, DQS_t, and DQS_c, VDD stands for VDDQ.
3. For CA0-9, CK_t, CK_c, and CS_n, VSS stands for VSSCA. For DQ, DM, DQS_t, and DQS_c, VSS stands for VSSQ.



8.2.4.4 AC and DC Logic Input Levels for Differential Signals

8.2.4.4.1 Differential Signal Definition

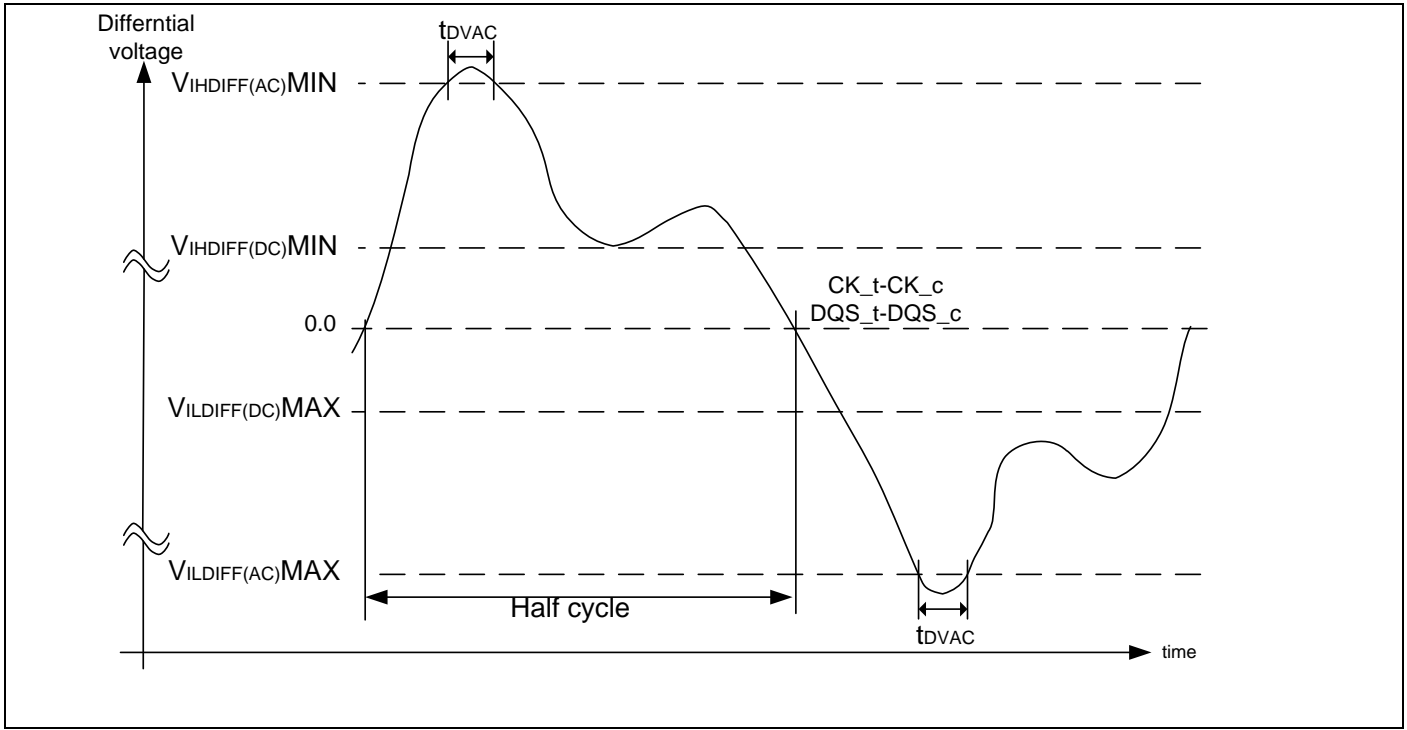

Figure of Definition of Differential AC-Swing and “Time above AC-Level” tdVAC

8.2.4.4.2 Differential swing requirements for clock (CK_t - CK_c) and strobe (DQS_t - DQS_c)

Table of Differential AC and DC Input Levels

Symbol	Parameter	LPDDR2-800		Unit	Notes
		Min	Max		
VIHdiff(dc)	Differential input high	$2 \times (V_{IH}(dc) - V_{ref})$	Note 3	V	1
VILdiff(dc)	Differential input logic low	Note 3	$2 \times (V_{IL}(dc) - V_{ref})$	V	1
VIHdiff(ac)	Differential input high ac	$2 \times (V_{IH}(ac) - V_{ref})$	Note 3	V	2
VILdiff(ac)	Differential input low ac	Note 3	$2 \times (V_{IL}(ac) - V_{ref})$	V	2

Notes:

- Used to define a differential signal slew-rate. For CK_t - CK_c use VIH/VIL(dc) of CA and VREFCA; for DQS_t - DQS_c, use VIH/VIL(dc) of DQs and VREFDQ; if a reduced dc-high or dc-low level is used for a signal group, then the reduced level applies also here.
- For CK_t - CK_c use VIH/VIL(ac) of CA and VREFCA; for DQS_t - DQS_c, use VIH/VIL(ac) of DQs and VREFDQ; if a reduced ac-high or ac-low level is used for a signal group, then the reduced level applies also here.
- These values are not defined, however the single-ended signals CK_t, CK_c, DQS_t, and DQS_c need to be within the respective limits (VIH(dc) max, VIL(dc)min) for single-ended signals as well as the limitations for overshoot and undershoot. Refer to section 8.2.5.5 “Overshoot and Undershoot Specifications”.
- For CK_t and CK_c, Vref = VrefCA(DC). For DQS_t and DQS_c, Vref = VrefDQ(DC).



Table of Allowed Time before Ringback (tDVAC) for CK_t - CK_c and DQS_t - DQS_c

Slew Rate [V/nS]	tDVAC [pS] @ VIHdiff(ac) or VILdiff(ac) = 440mV
> 4.0	175
4.0	170
3.0	167
2.0	163
1.8	162
1.6	161
1.4	159
1.2	155
1.0	150
< 1.0	150

8.2.4.5 Single-Ended Requirements for Differential Signals

Each individual component of a differential signal (CK_t, DQS_t, CK_c, or DQS_c) has also to comply with certain requirements for single-ended signals.

CK_t and CK_c shall meet VSEH(ac)min / VSEL(ac)max in every half-cycle.

DQS_t, DQS_c shall meet VSEH(ac)min / VSEL(ac)max in every half-cycle preceding and following a valid transition.

Note that the applicable ac-levels for CA and DQ's are different per speed-bin.

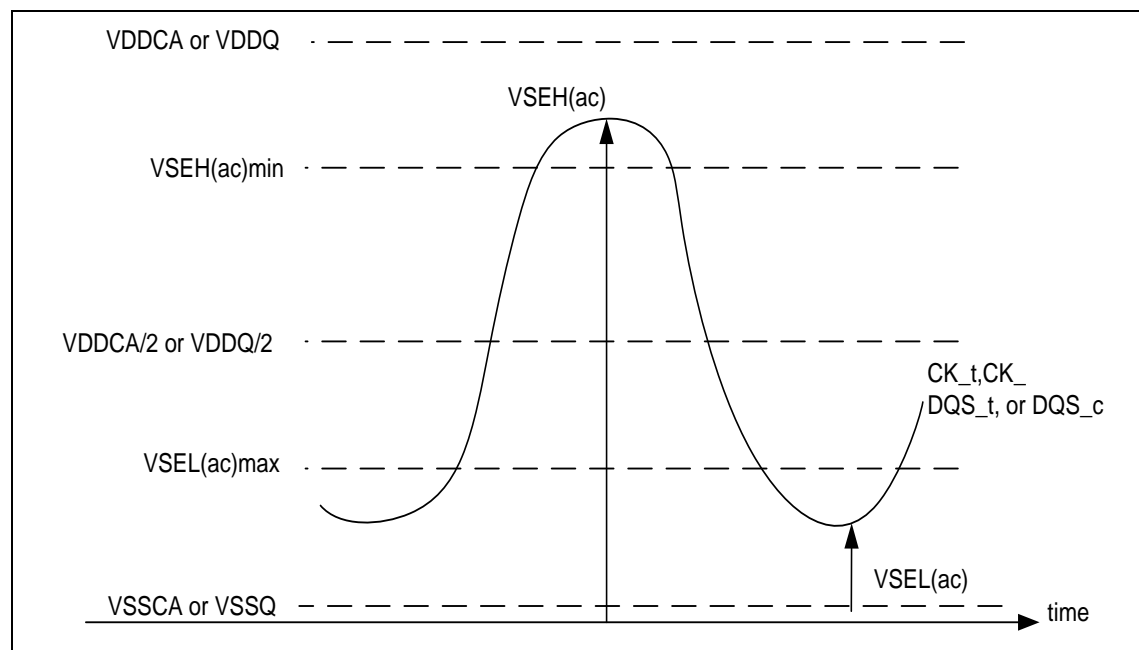

Figure of Single-Ended Requirement for Differential Signals



Note that while CA and DQ signal requirements are with respect to V_{ref} , the single-ended components of differential signals have a requirement with respect to $V_{DDQ}/2$ for DQS_t , DQS_c and $V_{DDCA}/2$ for CK_t , CK_c ; this is nominally the same. The transition of single-ended signals through the ac-levels is used to measure setup time. For single-ended components of differential signals the requirement to reach $V_{SEL(ac)max}$, $V_{SEH(ac)min}$ has no bearing on timing, but adds a restriction on the common mode characteristics of these signals.

The signal ended requirements for CK_t , CK_c , DQS_t and DQS_c are found in 8.2.4.1.1 “Single-Ended AC and DC Input Levels for CA and CS_n Inputs” table and 8.2.4.1.3 “Single-Ended AC and DC Input Levels for DQ and DM” table, respectively.

Table of Single-Ended Levels for CK_t , DQS_t , CK_c , DQS_c

Symbol	Parameter	LPDDR2-800		Unit	Notes
		Min	Max		
VSEH(AC)	Single-ended high-level for strobes	$(V_{DDQ}/2) + 0.220$	Note 3	V	1, 2
	Single-ended high-level for CK_t , CK_c	$(V_{DDCA}/2) + 0.220$	Note 3	V	1, 2
VSEL(AC)	Single-ended low-level for strobes	Note 3	$(V_{DDQ}/2) - 0.220$	V	1, 2
	Single-ended low-level for CK_t , CK_c	Note 3	$(V_{DDCA}/2) - 0.220$	V	1, 2

Notes:

- For CK_t , CK_c use $V_{SEH}/V_{SEL(ac)}$ of CA; for strobes ($DQS0_t$, $DQS0_c$, $DQS1_t$, $DQS1_c$, $DQS2_t$, $DQS2_c$, $DQS3_t$, $DQS3_c$) use $V_{IH}/V_{IL(ac)}$ of DQs.
- $V_{IH(ac)}/V_{IL(ac)}$ for DQs is based on V_{REFDQ} ; $V_{SEH(ac)}/V_{SEL(ac)}$ for CA is based on V_{REFCA} ; if a reduced ac-high or ac-low level is used for a signal group, then the reduced level applies also here.
- These values are not defined, however the single-ended signals CK_t , CK_c , $DQS0_t$, $DQS0_c$, $DQS1_t$, $DQS1_c$, $DQS2_t$, $DQS2_c$, $DQS3_t$, $DQS3_c$ need to be within the respective limits ($V_{IH(dc)}$ max, $V_{IL(dc)}$ min) for single-ended signals as well as the limitations for overshoot and undershoot. Refer to section 8.2.5.5 “Overshoot and Undershoot Specifications”.

8.2.4.6 Differential Input Cross Point Voltage

To guarantee tight setup and hold times as well as output skew parameters with respect to clock and strobe, each cross point voltage of differential input signals (CK_t , CK_c and DQS_t , DQS_c) must meet the requirements of above Single-ended levels for CK_t , DQS_t , CK_c , DQS_c table. The differential input cross point voltage V_{ix} is measured from the actual cross point of true and complement signals to the midlevel between of V_{DD} and V_{SS} .

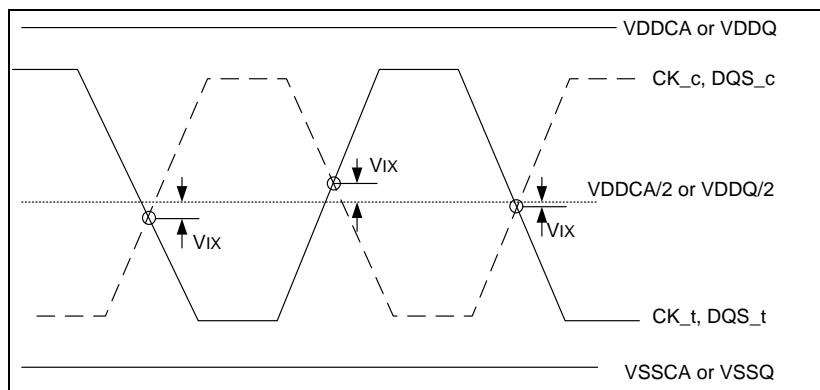

Figure of V_{ix} Definition



Table of Cross Point Voltage for Differential Input Signals (CK, DQS)

Symbol	Parameter	LPDDR2-800		Unit	Notes
		Min	Max		
VIXCA	Differential Input Cross Point Voltage relative to VDDCA/2 for CK_t, CK_c	- 120	120	mV	1, 2
VIXDQ	Differential Input Cross Point Voltage relative to VDDQ/2 for DQS_t, DQS_c	- 120	120	mV	1, 2

Notes:

- The typical value of VIX(AC) is expected to be about $0.5 \times VDD$ of the transmitting device, and VIX(AC) is expected to track variations in VDD. VIX(AC) indicates the voltage at which differential input signals must cross.
- For CK_t and CK_c, $V_{ref} = V_{refCA}(DC)$. For DQS_t and DQS_c, $V_{ref} = V_{refDQ}(DC)$.

8.2.4.7 Slew Rate Definitions for Single-Ended Input Signals

See section 8.7.2 “CA and CS_n Setup, Hold and Derating” for single-ended slew rate definitions for address and command signals.

See section 8.7.3 “Data Setup, Hold and Slew Rate Derating” for single-ended slew rate definitions for data signals.

8.2.4.8 Slew Rate Definitions for Differential Input Signals

Input slew rate for differential signals (CK_t, CK_c and DQS_t, DQS_c) are defined and measured as shown in below table and figure.

Table of Differential Input Slew Rate Definition

Description	Measured		Defined by
	from	to	
Differential input slew rate for rising edge (CK_t - CK_c and DQS_t - DQS_c).	V _{ILdiffmax}	V _{IHdiffmin}	$[V_{IHdiffmin} - V_{ILdiffmax}] / \Delta TR_{diff}$
Differential input slew rate for falling edge (CK_t - CK_c and DQS_t - DQS_c).	V _{IHdiffmin}	V _{ILdiffmax}	$[V_{IHdiffmin} - V_{ILdiffmax}] / \Delta TF_{diff}$

Note: The differential signal (i.e. CK_t - CK_c and DQS_t - DQS_c) must be linear between these thresholds.

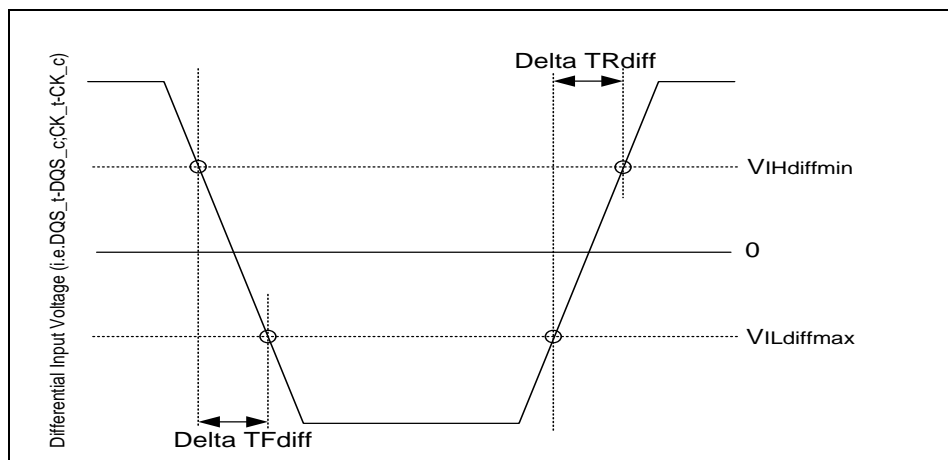

Figure of Differential Input Slew Rate Definition for DQS_t, DQS_c and CK_t, CK_c



8.2.5 AC and DC Output Measurement Levels

8.2.5.1 Single Ended AC and DC Output Levels

Table of Single-Ended AC and DC Output Levels

Symbol	Parameter	LPDDR2-800		Unit	Notes
VOH(DC)	DC output high measurement level (for IV curve linearity)	0.9 x VDDQ		V	1
VOL(DC)	DC output low measurement level (for IV curve linearity)	0.1 x VDDQ		V	2
VOH(AC)	AC output high measurement level (for output slew rate)	VREFDQ + 0.12		V	
VOL(AC)	AC output low measurement level (for output slew rate)	VREFDQ - 0.12		V	
IOZ	Output Leakage current (DQ, DM, DQS_t, DQS_c) (DQ, DQS_t, DQS_c are disabled; 0V ≤ Vout ≤ VDDQ)	Min	-5	μA	
		Max	+5		
MM _{PUPD}	Delta RON between pull-up and pull-down for DQ/DM	Min	-15	%	
		Max	+15		

Notes:

1. IOH = -0.1mA.
2. IOL = +0.1mA.

8.2.5.2 Differential AC and DC Output Levels

Table of Differential AC and DC Output Levels of (DQS_t, DQS_c)

Symbol	Parameter	LPDDR2-800	Unit	Notes
VOH _{diff} (AC)	AC differential output high measurement level (for output SR)	+ 0.20 x VDDQ	V	
VOL _{diff} (AC)	AC differential output low measurement level (for output SR)	- 0.20 x VDDQ	V	

Notes:

1. IOH = -0.1mA.
2. IOL = +0.1mA.

8.2.5.3 Single Ended Output Slew Rate

With the reference load for timing measurements, output slew rate for falling and rising edges is defined and measured between VOL(AC) and VOH(AC) for single ended signals as shown in below table and figure.

Table of Single-Ended Output Slew Rate Definition

Description	Measured		Defined by
	from	to	
Single-ended output slew rate for rising edge	VOL(AC)	VOH(AC)	[VOH(AC) - VOL(AC)] / DeltaTRse
Single-ended output slew rate for falling edge	VOH(AC)	VOL(AC)	[VOH(AC) - VOL(AC)] / DeltaTFse

Note: Output slew rate is verified by design and characterization, and may not be subject to production test.

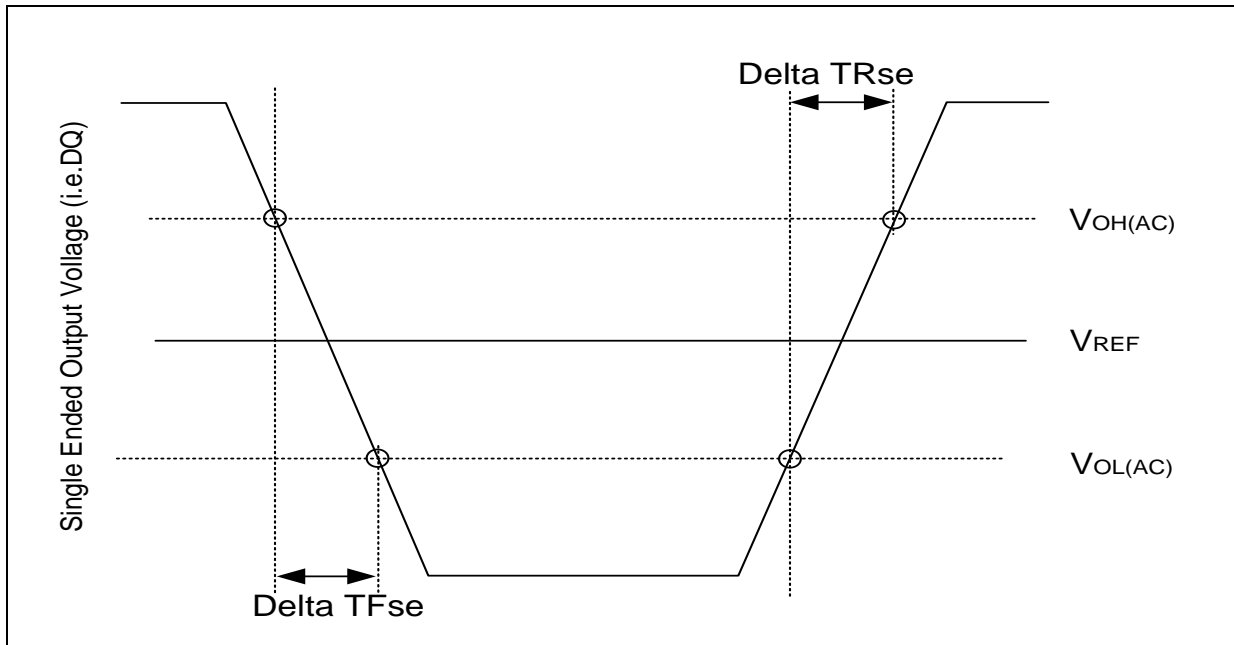

Figure of Single Ended Output Slew Rate Definition

Table of Output Slew Rate (Single-Ended)

Symbol	Parameter	LPDDR2-800		Units
		Min	Max	
SRQse	Single-ended Output Slew Rate (RON = 40Ω ± 30%)	1.5	3.5	V/nS
SRQse	Single-ended Output Slew Rate (RON = 60Ω ± 30%)	1.0	2.5	V/nS
	Output slew-rate matching Ratio (Pull-up to Pull-down)	0.7	1.4	

Description:

SR: Slew Rate

Q: Query Output (like in DQ, which stands for Data-in, Query-Output)

se: Single-ended Signals

Notes:

1. Measured with output reference load.
2. The ratio of pull-up to pull-down slew rate is specified for the same temperature and voltage, over the entire temperature and voltage range. For a given output, it represents the maximum difference between pull-up and pull-down drivers due to process variation.
3. The output slew rate for falling and rising edges is defined and measured between V_{OL(AC)} and V_{OH(AC)}.
4. Slew rates are measured under normal SSO conditions, with 1/2 of DQ signals per data byte driving logic high and 1/2 of DQ signals per data byte driving logic low.



8.2.5.4 Differential Output Slew Rate

With the reference load for timing measurements, output slew rate for falling and rising edges is defined and measured between VOLdiff(AC) and VOHdiff(AC) for differential signals as shown in below table and figure.

Table of Differential Output Slew Rate Definition

Description	Measured		Defined by
	from	to	
Differential output slew rate for rising edge	VOLdiff(AC)	VOHdiff(AC)	$[VOH_{diff}(AC) - VOL_{diff}(AC)] / \Delta TR_{diff}$
Differential output slew rate for falling edge	VOHdiff(AC)	VOLdiff(AC)	$[VOH_{diff}(AC) - VOL_{diff}(AC)] / \Delta TF_{diff}$

Note: Output slew rate is verified by design and characterization, and may not be subject to production test.

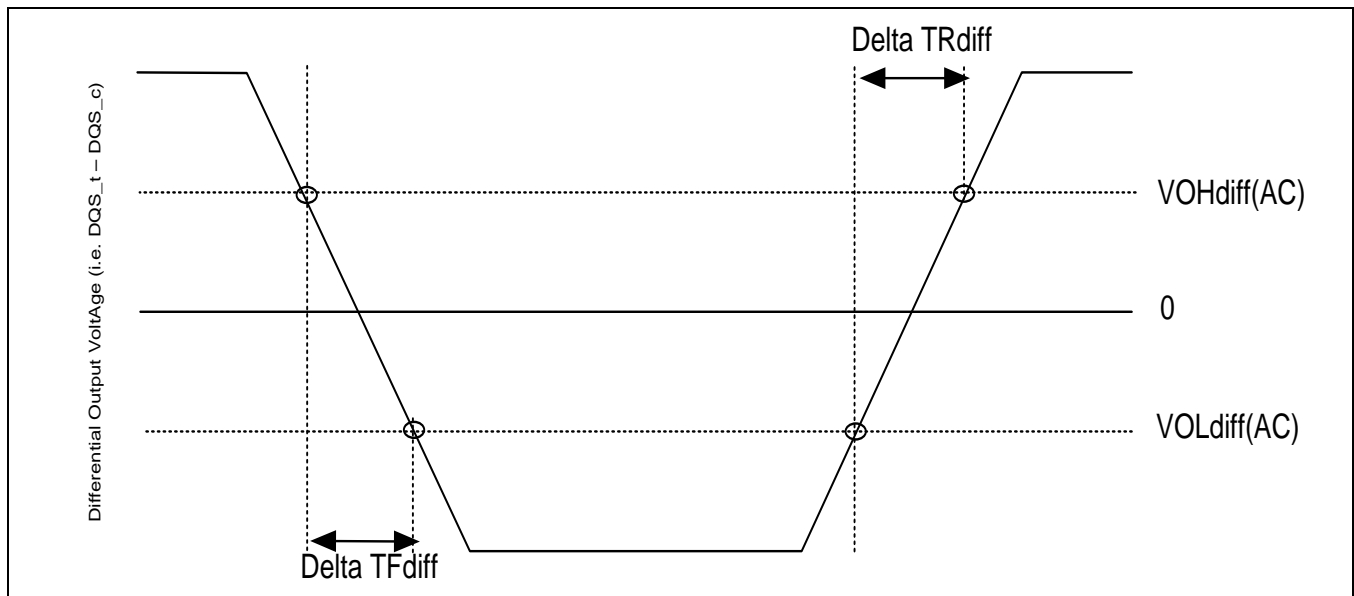

Figure of Differential Output Slew Rate Definition

Table of Differential Output Slew Rate

Symbol	Parameter	LPDDR2-800		Units
		Min	Max	
SRQdiff	Differential Output Slew Rate (RON = 40Ω ± 30%)	3.0	7.0	V/nS
SRQdiff	Differential Output Slew Rate (RON = 60Ω ± 30%)	2.0	5.0	V/nS

Description:

SR: Slew Rate

Q: Query Output (like in DQ, which stands for Data-in, Query-Output)

diff: differential Signals

Notes:

1. Measured with output reference load.
2. The output slew rate for falling and rising edges is defined and measured between VOLdiff(AC) and VOHdiff(AC).
3. Slew rates are measured under normal SSO conditions, with 1/2 of DQ signals per data byte driving logic-high and 1/2 of DQ signals per data byte driving logic-low.



8.2.5.5 Overshoot and Undershoot Specifications

Table of AC Overshoot/Undershoot Specification

Parameter		LPDDR2					Unit
		800	667	533	400	333	
Maximum peak amplitude allowed for overshoot area. (See figure below)	Max	0.35					V
Maximum peak amplitude allowed for undershoot area. (See figure below)	Max	0.35					V
Maximum area above VDD. (See figure below)	Max	0.20	0.24	0.30	0.40	0.48	V-nS
Maximum area below VSS. (See figure below)	Max	0.20	0.24	0.30	0.40	0.48	V-nS

(CA0-9, CS_n, CKE, CK_t, CK_c, DQ, DQS_t, DQS_c, DM)

Notes:

1. For CA0-9, CK_t, CK_c, CS_n, and CKE, VDD stands for VDDCA. For DQ, DM, DQS_t, and DQS_c, VDD stands for VDDQ.
2. For CA0-9, CK_t, CK_c, CS_n, and CKE, VSS stands for VSSCA. For DQ, DM, DQS_t, and DQS_c, VSS stands for VSSQ.
3. Maximum peak amplitude values are referenced from actual VDD and VSS values.
4. Maximum area values are referenced from maximum operating VDD and VSS values.

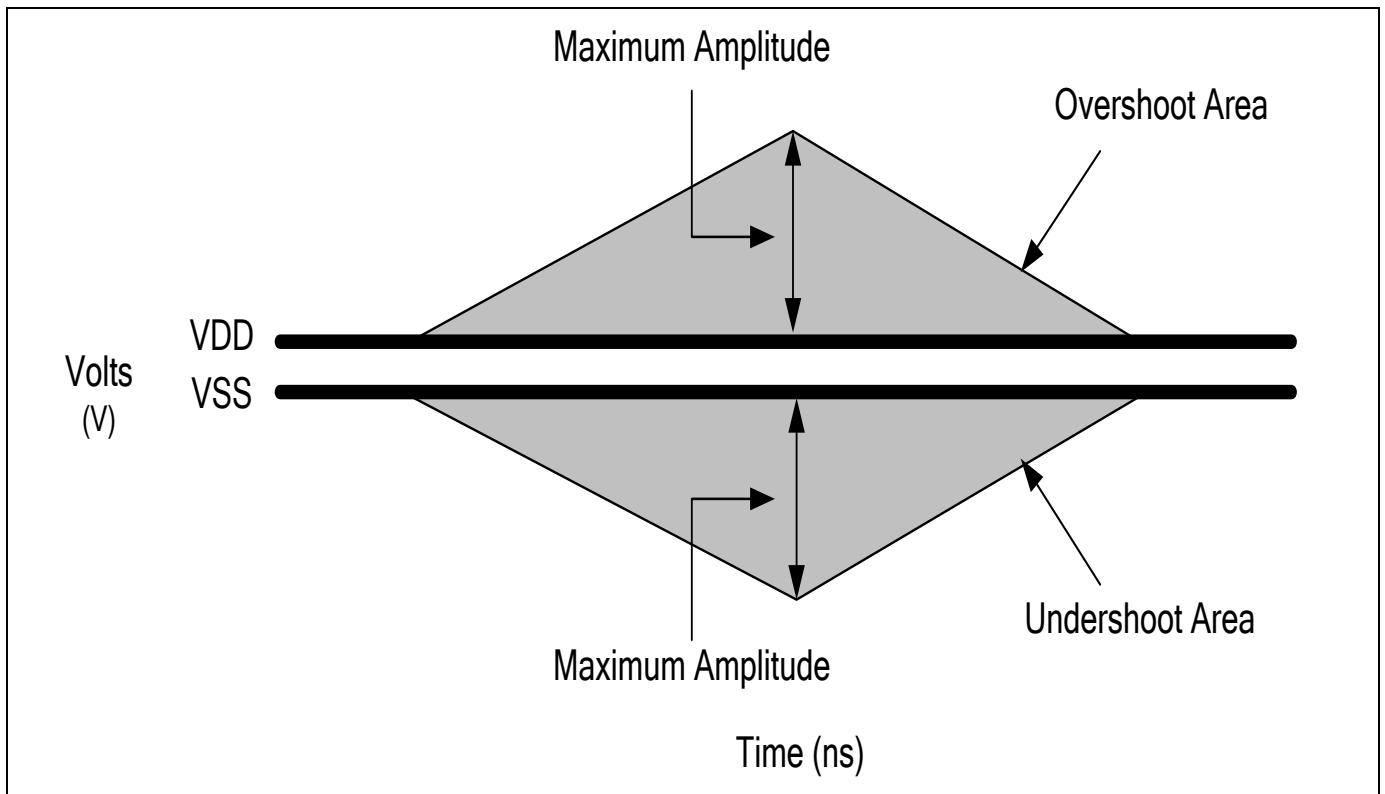

Figure of Overshoot and Undershoot Definition

Notes:

1. For CA0-9, CK_t, CK_c, CS_n, and CKE, VDD stands for VDDCA. For DQ, DM, DQS_t, and DQS_c, VDD stands for VDDQ.
2. For CA0-9, CK_t, CK_c, CS_n, and CKE, VSS stands for VSSCA. For DQ, DM, DQS_t, and DQS_c, VSS stands for VSSQ.
3. Maximum peak amplitude values are referenced from actual VDD and VSS values.
4. Maximum area values are referenced from maximum operating VDD and VSS values.



8.2.6 Output buffer Characteristics

8.2.6.1 HSUL_12 Driver Output Timing Reference Load

These ‘Timing Reference Loads’ are not intended as a precise representation of any particular system environment or a depiction of the actual load presented by a production tester. System designers should use IBIS or other simulation tools to correlate the timing reference load to a system environment. Manufacturers correlate to their production test conditions, generally one or more coaxial transmission lines terminated at the tester electronics.

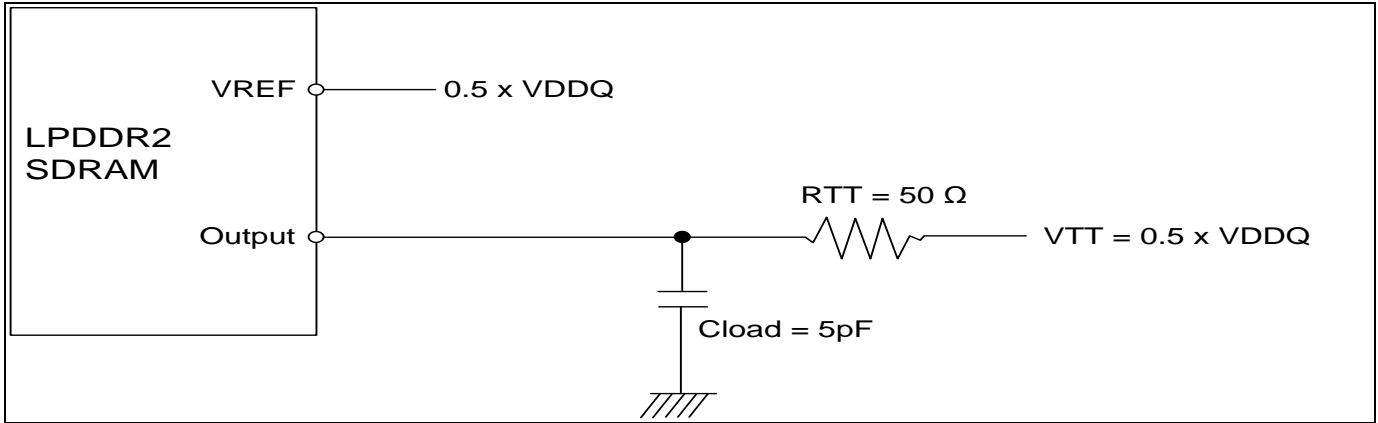

Figure of HSUL_12 Driver Output Reference Load for Timing and Slew Rate

Note:

All output timing parameter values (like tDQSCK, tDQSQ, tQHS, tHZ, tRPRE etc.) are reported with respect to this reference load. This reference load is also used to report slew rate.

8.2.6.2 RON_{PU} and RON_{PD} Resistor Definition

$$RON_{PU} = \frac{(VDDQ - V_{out})}{ABS(I_{out})}$$

Note: This is under the condition that RON_{PD} is turned off

$$RON_{PD} = \frac{V_{out}}{ABS(I_{out})}$$

Note: This is under the condition that RON_{PU} is turned off

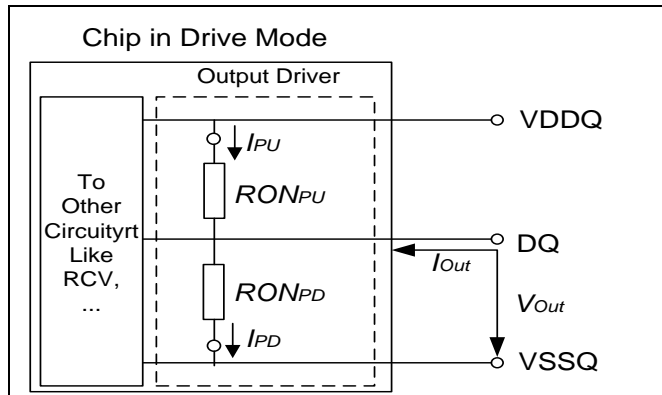

Figure of Output Driver Definition of Voltages and Currents



8.2.6.3 RON_{PU} and RON_{PD} Characteristics with ZQ Calibration

Output driver impedance RON is defined by the value of the external reference resistor RZQ. Nominal RZQ is 240Ω.

Table of Output Driver DC Electrical Characteristics with ZQ Calibration

RON _{NOM}	Resistor	Vout	Min	Nom	Max	Unit	Note
34.3Ω	RON34PD	0.5 x VDDQ	0.85	1.00	1.15	RZQ/7	1, 2, 3, 4
	RON34PU	0.5 x VDDQ	0.85	1.00	1.15	RZQ/7	1, 2, 3, 4
40.0Ω	RON40PD	0.5 x VDDQ	0.85	1.00	1.15	RZQ/6	1, 2, 3, 4
	RON40PU	0.5 x VDDQ	0.85	1.00	1.15	RZQ/6	1, 2, 3, 4
48.0Ω	RON48PD	0.5 x VDDQ	0.85	1.00	1.15	RZQ/5	1, 2, 3, 4
	RON48PU	0.5 x VDDQ	0.85	1.00	1.15	RZQ/5	1, 2, 3, 4
60.0Ω	RON60PD	0.5 x VDDQ	0.85	1.00	1.15	RZQ/4	1, 2, 3, 4
	RON60PU	0.5 x VDDQ	0.85	1.00	1.15	RZQ/4	1, 2, 3, 4
80.0Ω	RON80PD	0.5 x VDDQ	0.85	1.00	1.15	RZQ/3	1, 2, 3, 4
	RON80PU	0.5 x VDDQ	0.85	1.00	1.15	RZQ/3	1, 2, 3, 4
120.0Ω	RON120PD	0.5 x VDDQ	0.85	1.00	1.15	RZQ/2	1, 2, 3, 4
	RON120PU	0.5 x VDDQ	0.85	1.00	1.15	RZQ/2	1, 2, 3, 4
Mismatch between pull-up and pull-down	MM _{PUPD}		-15.00		+15.00	%	1, 2, 3, 4, 5

Notes:

- Across entire operating temperature range, after calibration.
- RZQ = 240Ω.
- The tolerance limits are specified after calibration with fixed voltage and temperature. For behavior of the tolerance limits if temperature or voltage changes after calibration, see following section on voltage and temperature sensitivity.
- Pull-down and pull-up output driver impedances are recommended to be calibrated at 0.5 x VDDQ.
- Measurement definition for mismatch between pull-up and pull-down: MMPUPD: Measure RON_{PU} and RON_{PD}, both at 0.5 x VDDQ:

$$MMPUPD = \frac{RON_{PU} - RON_{PD}}{RON_{NOM}} \times 100$$

For example, with MMPUPD(max) = 15% and RON_{PD} = 0.85, RON_{PU} must be less than 1.0.

8.2.6.4 Output Driver Temperature and Voltage Sensitivity

If temperature and/or voltage change after calibration, the tolerance limits widen according to the tables shown below.

Table of Output Driver Sensitivity Definition

Resistor	Vout	Min	Max	Unit	Notes
RON _{PD}	0.5 x VDDQ	85 - (dRON _{dT} × ΔT) - (dRON _{dV} × ΔV)	115 + (dRON _{dT} × ΔT) + (dRON _{dV} × ΔV)	%	1, 2
RON _{PU}					

Notes:

- ΔT = T - T (@calibration), ΔV = V - V (@calibration).
- dRON_{dT} and dRON_{dV} are not subject to production test but are verified by design and characterization.

Table of Output Driver Temperature and Voltage Sensitivity

Symbol	Parameter	Min	Max	Unit	Note
dRON _{dT}	RON Temperature Sensitivity	0.00	0.75	% / °C	
dRON _{dV}	RON Voltage Sensitivity	0.00	0.20	% / mV	



8.2.6.5 RON_{PU} and RON_{PD} Characteristics without ZQ Calibration

Output driver impedance RON is defined by design and characterization as default setting.

Table of Output Driver DC Electrical Characteristics without ZQ Calibration

RON _{NOM}	Resistor	V _{out}	Min	Nom	Max	Unit	Note
34.3Ω	RON34PD	0.5 x V _{DDQ}	24	34.3	44.6	Ω	1
	RON34PU	0.5 x V _{DDQ}	24	34.3	44.6	Ω	1
40.0Ω	RON40PD	0.5 x V _{DDQ}	28	40	52	Ω	1
	RON40PU	0.5 x V _{DDQ}	28	40	52	Ω	1
48.0Ω	RON48PD	0.5 x V _{DDQ}	33.6	48	62.4	Ω	1
	RON48PU	0.5 x V _{DDQ}	33.6	48	62.4	Ω	1
60.0Ω	RON60PD	0.5 x V _{DDQ}	42	60	78	Ω	1
	RON60PU	0.5 x V _{DDQ}	42	60	78	Ω	1
80.0Ω	RON80PD	0.5 x V _{DDQ}	56	80	104	Ω	1
	RON80PU	0.5 x V _{DDQ}	56	80	104	Ω	1
120.0Ω	RON120PD	0.5 x V _{DDQ}	84	120	156	Ω	1
	RON120PU	0.5 x V _{DDQ}	84	120	156	Ω	1

Note: Across entire operating temperature range, without calibration.



8.2.6.6 RZQ I-V Curve

Table of RZQ I-V Curve

Voltage[V]	RON = 240Ω (RZQ)							
	Pull-Down				Pull-Up			
	Current [mA] / RON [Ohms]				Current [mA] / RON [Ohms]			
	default value after ZQReset		With Calibration		default value after ZQReset		With Calibration	
	Min	Max	Min	Max	Min	Max	Min	Max
	[mA]	[mA]	[mA]	[mA]	[mA]	[mA]	[mA]	[mA]
0.00	0.00	0.00	0.00	0.00	0.00	0.00	0.00	0.00
0.05	0.19	0.32	0.21	0.26	-0.19	-0.32	-0.21	-0.26
0.10	0.38	0.64	0.40	0.53	-0.38	-0.64	-0.40	-0.53
0.15	0.56	0.94	0.60	0.78	-0.56	-0.94	-0.60	-0.78
0.20	0.74	1.26	0.79	1.04	-0.74	-1.26	-0.79	-1.04
0.25	0.92	1.57	0.98	1.29	-0.92	-1.57	-0.98	-1.29
0.30	1.08	1.86	1.17	1.53	-1.08	-1.86	-1.17	-1.53
0.35	1.25	2.17	1.35	1.79	-1.25	-2.17	-1.35	-1.79
0.40	1.40	2.46	1.52	2.03	-1.40	-2.46	-1.52	-2.03
0.45	1.54	2.74	1.69	2.26	-1.54	-2.74	-1.69	-2.26
0.50	1.68	3.02	1.86	2.49	-1.68	-3.02	-1.86	-2.49
0.55	1.81	3.30	2.02	2.72	-1.81	-3.30	-2.02	-2.72
0.60	1.92	3.57	2.17	2.94	-1.92	-3.57	-2.17	-2.94
0.65	2.02	3.83	2.32	3.15	-2.02	-3.83	-2.32	-3.15
0.70	2.11	4.08	2.46	3.36	-2.11	-4.08	-2.46	-3.36
0.75	2.19	4.31	2.58	3.55	-2.19	-4.31	-2.58	-3.55
0.80	2.25	4.54	2.70	3.74	-2.25	-4.54	-2.70	-3.74
0.85	2.30	4.74	2.81	3.91	-2.30	-4.74	-2.81	-3.91
0.90	2.34	4.92	2.89	4.05	-2.34	-4.92	-2.89	-4.05
0.95	2.37	5.08	2.97	4.23	-2.37	-5.08	-2.97	-4.23
1.00	2.41	5.20	3.04	4.33	-2.41	-5.20	-3.04	-4.33
1.05	2.43	5.31	3.09	4.44	-2.43	-5.31	-3.09	-4.44
1.10	2.46	5.41	3.14	4.52	-2.46	-5.41	-3.14	-4.52
1.15	2.48	5.48	3.19	4.59	-2.48	-5.48	-3.19	-4.59
1.20	2.50	5.55	3.23	4.65	-2.50	-5.55	-3.23	-4.65

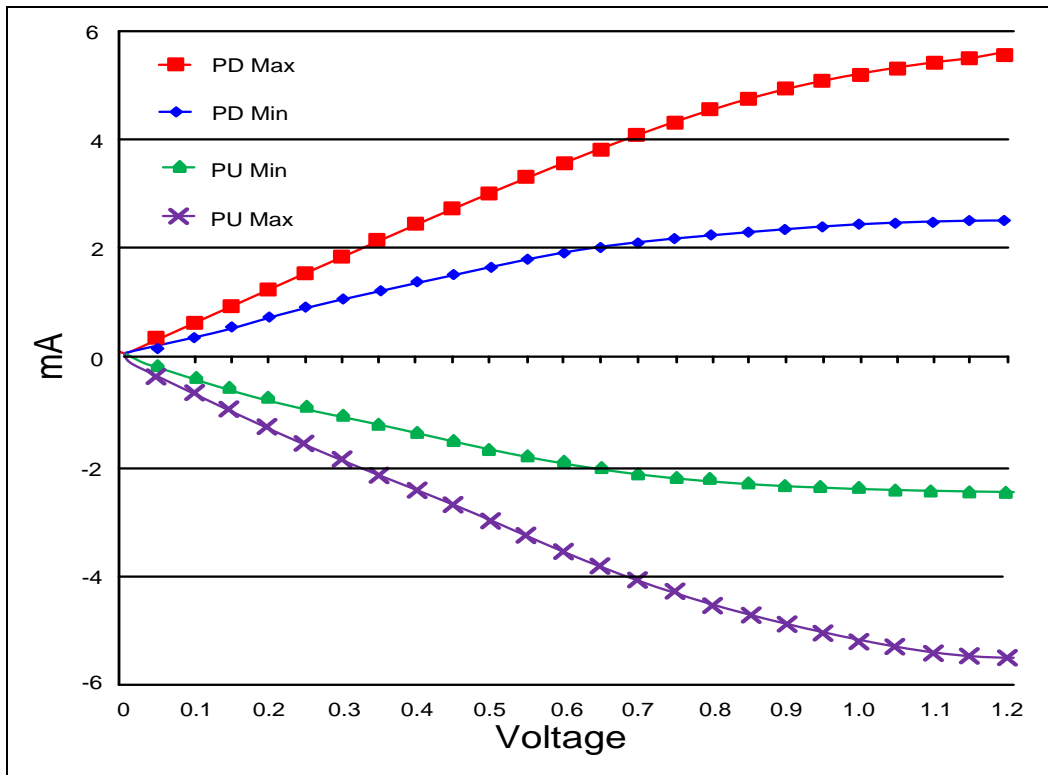

Figure of RON = 240 Ohms IV Curve after ZQReset

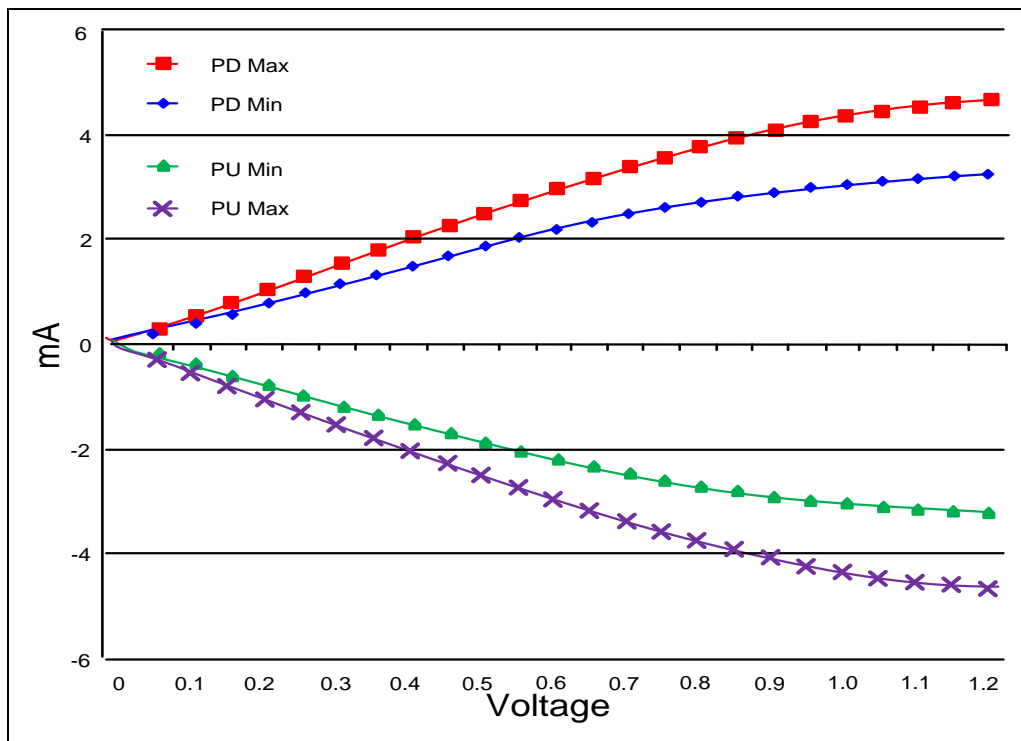

Figure of RON = 240 Ohms IV Curve after Calibration



8.2.6.7 Input/Output Capacitance

Table of Input/Output Capacitance

Parameter	Symbol	Min	Max	Units	Note
Package Input capacitance, CK_t and CK_c	CPKGCK	1	3	pF	1, 2
Package Input capacitance delta, CK_t and CK_c	CDPKGCK	0	0.2	pF	1, 2, 3
Package Input capacitance, all other input-only pins	CPKGI	1	3	pF	1, 2, 4
Package Input capacitance delta, all other input-only pins	CDPKGCI	-0.5	0.5	pF	1, 2, 5
Package Input/output capacitance, DQ, DM, DQS_t, DQS_c	CPKGIO	1.25	3.5	pF	1, 2, 7
Package Input/output capacitance delta, DQS_t, DQS_c	CDPKGDQS	0	0.25	pF	1, 2, 6
Package Input/output capacitance delta, DQ, DM	CDPKGIO	-0.5	0.5	pF	1, 2, 7
Package Input/output capacitance, ZQ Pin	CPKGZQ	0	3.5	pF	1, 2

(TOPER; VDDQ = 1.14- 1.3V; VDDCA = 1.14-1.3V; VDD1 = 1.7-1.95V, LPDDR2-S4 VDD2 = 1.14-1.3V).

Notes:

1. This parameter is not subject to production test. It is verified by design and characterization. The capacitance is measured according to JEP147 (Procedure for measuring input capacitance using a vector network analyzer (VNA) with VDD1, VDD2, VDDQ, VSS, VSSCA, VSSQ applied and all other pins floating).
2. This parameter applies to package only (does not include die capacitance). This value is vendor specific.
3. Absolute value of CPKGCK_t - CPKGCK_c.
4. CPKGI applies to CS_n, CKE, CA0-CA9
5. CDPKGI = CPKGI - 0.5 * (CPKGDQS_t + CPKGDQS_c).
6. Absolute value of CDPKGDQS_t and CDPKGDQS_c.
7. CDPKGIO = CPKGIO - 0.5 * (CPKGDQS_t + CPKGDQS_c) in byte lane.
8. Maximum external load capacitance on ZQ pin, including packaging, board, pin, resistor, and other LPDDR2 devices: 5 pF.



8.3 IDD Specification Parameters and Test Conditions

8.3.1 IDD Measurement Conditions

The following definitions are used within the IDD measurement tables:

LOW: $V_{IN} \leq V_{IL(DC) MAX}$

HIGH: $V_{IN} \geq V_{IH(DC) MIN}$

STABLE: Inputs are stable at a HIGH or LOW level

SWITCHING: See tables below.

8.3.1.1 Definition of Switching for CA Input Signals

Switching for CA								
	CK_t (RISING) / Ck_C (FALLING)	CK_t (FALLING) / Ck_C (RISING)	CK_t (RISING) / Ck_C (FALLING)	CK_t (FALLING) / Ck_C (RISING)	CK_t (RISING) / Ck_C (FALLING)	CK_t (FALLING) / Ck_C (RISING)	CK_t (RISING) / Ck_C (FALLING)	CK_t (FALLING) / Ck_C (RISING)
Cycle	N		N+1		N+2		N+3	
CS_n	HIGH		HIGH		HIGH		HIGH	
CA0	HIGH	LOW	LOW	LOW	LOW	HIGH	HIGH	HIGH
CA1	HIGH	HIGH	HIGH	LOW	LOW	LOW	LOW	HIGH
CA2	HIGH	LOW	LOW	LOW	LOW	HIGH	HIGH	HIGH
CA3	HIGH	HIGH	HIGH	LOW	LOW	LOW	LOW	HIGH
CA4	HIGH	LOW	LOW	LOW	LOW	HIGH	HIGH	HIGH
CA5	HIGH	HIGH	HIGH	LOW	LOW	LOW	LOW	HIGH
CA6	HIGH	LOW	LOW	LOW	LOW	HIGH	HIGH	HIGH
CA7	HIGH	HIGH	HIGH	LOW	LOW	LOW	LOW	HIGH
CA8	HIGH	LOW	LOW	LOW	LOW	HIGH	HIGH	HIGH
CA9	HIGH	HIGH	HIGH	LOW	LOW	LOW	LOW	HIGH

Notes:

1. CS_n must always be driven HIGH.
2. 50% of CA bus is changing between HIGH and LOW once per clock for the CA bus.
3. The above pattern (N, N+1, N+2, N+3...) is used continuously during IDD measurement for IDD values that require SWITCHING on the CA bus.



8.3.1.2 Definition of Switching for IDD4R

Clock	CKE	CS_n	Clock Cycle Number	Command	CA0-CA2	CA3-CA9	All DQ
Rising	HIGH	LOW	N	Read_Rising	HLH	LHLHLHL	L
Falling	HIGH	LOW	N	Read_Falling	LLL	LLLLLLL	L
Rising	HIGH	HIGH	N + 1	NOP	LLL	LLLLLLL	H
Falling	HIGH	HIGH	N + 1	NOP	HLH	HLHLLHL	L
Rising	HIGH	LOW	N + 2	Read_Rising	HLH	HLHLLHL	H
Falling	HIGH	LOW	N + 2	Read_Falling	LLL	HHHHHHH	H
Rising	HIGH	HIGH	N + 3	NOP	LLL	HHHHHHH	H
Falling	HIGH	HIGH	N + 3	NOP	HLH	LHLHLHL	L

Notes:

1. Data strobe (DQS) is changing between HIGH and LOW every clock cycle.
2. The above pattern (N, N+1...) is used continuously during IDD measurement for IDD4R.

8.3.1.3 Definition of Switching for IDD4W

Clock	CKE	CS_n	Clock Cycle Number	Command	CA0-CA2	CA3-CA9	All DQ
Rising	HIGH	LOW	N	Write_Rising	HLL	LHLHLHL	L
Falling	HIGH	LOW	N	Write_Falling	LLL	LLLLLLL	L
Rising	HIGH	HIGH	N + 1	NOP	LLL	LLLLLLL	H
Falling	HIGH	HIGH	N + 1	NOP	HLH	HLHLLHL	L
Rising	HIGH	LOW	N + 2	Write_Rising	HLL	HLHLLHL	H
Falling	HIGH	LOW	N + 2	Write_Falling	LLL	HHHHHHH	H
Rising	HIGH	HIGH	N + 3	NOP	LLL	HHHHHHH	H
Falling	HIGH	HIGH	N + 3	NOP	HLH	LHLHLHL	L

Notes:

1. Data strobe (DQS) is changing between HIGH and LOW every clock cycle.
2. Data masking (DM) must always be driven LOW.
3. The above pattern (N, N+1...) is used continuously during IDD measurement for IDD4W.



8.3.2 IDD Specifications

8.3.2.1 LPDDR2 IDD Specification Parameters and Operating Conditions, -40°C~85°C (x16, x32)

Parameter/Condition	Symbol	Power Supply	400 MHz	Unit	Notes
Operating one bank active-precharge current: tCK = tCK(avg)min; tRC = tRCmin; CKE is HIGH; CS_n is HIGH between valid commands; CA bus inputs are SWITCHING; Data bus inputs are STABLE	IDD0 ₁	VDD1	10	mA	1
	IDD0 ₂	VDD2	40	mA	1
	IDD0 _{IN}	VDDCA VDDQ	6	mA	1, 2
Idle power-down standby current: tCK = tCK(avg)min; CKE is LOW; CS_n is HIGH; All banks/RBs idle; CA bus inputs are SWITCHING; Data bus inputs are STABLE	IDD2P ₁	VDD1	750	μA	1
	IDD2P ₂	VDD2	750	μA	1
	IDD2P _{IN}	VDDCA VDDQ	60	μA	1, 2
Idle power-down standby current with clock stop: CK_t=LOW, CK_c=HIGH; CKE is LOW; CS_n is HIGH; All banks/RBs idle; CA bus inputs are STABLE; Data bus inputs are STABLE	IDD2PS ₁	VDD1	750	μA	1
	IDD2PS ₂	VDD2	750	μA	1
	IDD2PS _{IN}	VDDCA VDDQ	60	μA	1, 2
Idle non power-down standby current: tCK = tCK(avg)min; CKE is HIGH; CS_n is HIGH; All banks/RBs idle; CA bus inputs are SWITCHING; Data bus inputs are STABLE	IDD2N ₁	VDD1	1.5	mA	1
	IDD2N ₂	VDD2	13.2	mA	1
	IDD2N _{IN}	VDDCA VDDQ	6	mA	1, 2
Idle non power-down standby current with clock stop: CK_t=LOW, CK_c=HIGH; CKE is HIGH; CS_n is HIGH; All banks/RBs idle; CA bus inputs are STABLE; Data bus inputs are STABLE	IDD2NS ₁	VDD1	1.5	mA	1
	IDD2NS ₂	VDD2	5	mA	1
	IDD2NS _{IN}	VDDCA VDDQ	6	mA	1, 2
Active power-down standby current: tCK = tCK(avg)min; CKE is LOW; CS_n is HIGH; One bank/RB active; CA bus inputs are SWITCHING; Data bus inputs are STABLE	IDD3P ₁	VDD1	2	mA	1
	IDD3P ₂	VDD2	5	mA	1
	IDD3P _{IN}	VDDCA VDDQ	60	μA	1, 2
Active power-down standby current with clock stop: CK_t=LOW, CK_c=HIGH; CKE is LOW; CS_n is HIGH; One bank/RB active; CA bus inputs are STABLE; Data bus inputs are STABLE	IDD3PS ₁	VDD1	2	mA	1
	IDD3PS ₂	VDD2	5	mA	1
	IDD3PS _{IN}	VDDCA VDDQ	60	μA	1, 2
Active non power-down standby current: tCK = tCK(avg)min; CKE is HIGH; CS_n is HIGH; One bank/RB active; CA bus inputs are SWITCHING; Data bus inputs are STABLE	IDD3N ₁	VDD1	2	mA	1
	IDD3N ₂	VDD2	15	mA	1
	IDD3N _{IN}	VDDCA VDDQ	6	mA	1, 2
Active non power-down standby current with clock stop: CK_t=LOW, CK_c=HIGH; CKE is HIGH; CS_n is HIGH; One bank/RB active; CA bus inputs are STABLE; Data bus inputs are STABLE	IDD3NS ₁	VDD1	2	mA	1
	IDD3NS ₂	VDD2	7	mA	1
	IDD3NS _{IN}	VDDCA VDDQ	6	mA	1, 2



Parameter/Condition	Symbol	Power Supply	400 MHz	Unit	Notes
Operating burst read current: tCK = tCK(avg)min; CS_n is HIGH between valid commands; One bank/RB active; BL = 4; RL = RLmin; CA bus inputs are SWITCHING; 50% data change each burst transfer	IDD4R ₁	VDD1	4	mA	1
	IDD4R ₂	VDD2	170	mA	1
	IDD4R _{IN}	VDDCA VDDQ	256	mA	1
Operating burst write current: tCK = tCK(avg)min; CS_n is HIGH between valid commands; One bank/RB active; BL = 4; WL = WLmin; CA bus inputs are SWITCHING; 50% data change each burst transfer	IDD4W ₁	VDD1	4	mA	1
	IDD4W ₂	VDD2	190	mA	1
	IDD4W _{IN}	VDDCA VDDQ	23.5	mA	1, 2
All Bank Refresh Burst current: tCK = tCK(avg)min; CKE is HIGH between valid commands; tRC = tRFCabmin; Burst refresh; CA bus inputs are SWITCHING; Data bus inputs are STABLE;	IDD5 ₁	VDD1	35	mA	1
	IDD5 ₂	VDD2	120	mA	1
	IDD5 _{IN}	VDDCA VDDQ	6	mA	1, 2
All Bank Refresh Average current: tCK = tCK(avg)min; CKE is HIGH between valid commands; tRC = tREFI; CA bus inputs are SWITCHING; Data bus inputs are STABLE;	IDD5AB ₁	VDD1	3	mA	1
	IDD5AB ₂	VDD2	15	mA	1
	IDD5AB _{IN}	VDDCA VDDQ	6	mA	1, 2
Per Bank Refresh Average current: tCK = tCK(avg)min; CKE is HIGH between valid commands; tRC = tREFI/8; CA bus inputs are SWITCHING; Data bus inputs are STABLE;	IDD5PB ₁	VDD1	3	mA	1
	IDD5PB ₂	VDD2	15.3	mA	1
	IDD5PB _{IN}	VDDCA VDDQ	6	mA	1, 2
Deep Power-Down current: CK_t=LOW, CK_c=HIGH; CKE is LOW; CA bus inputs are STABLE; Data bus inputs are STABLE;	IDD8 ₁	VDD1	10	μA	1
	IDD8 ₂	VDD2	25	μA	1
	IDD8 _{IN}	VDDCA VDDQ	60	μA	1, 2

Notes:

1. IDD values published are the maximum of the distribution of the arithmetic mean.
2. Measured currents are the summation of VDDQ and VDDCA.
3. IDD current specifications are tested after the device is properly initialized.



8.3.2.2 IDD6 Partial Array Self-Refresh Current, -40°C~85°C (x16, x32)

Parameter		Symbol	Power Supply	400 MHz	Condition	Unit
IDD6 Partial Array Self-Refresh Current	Full Array	IDD6 ₁	VDD1	1200	Self refresh current CK _t =LOW, CK _c =HIGH; CKE is LOW; CA bus inputs are STABLE; Data bus inputs are STABLE;	μA
		IDD6 ₂	VDD2	3500		
		IDD6 _{IN}	VDDCA VDDQ	60		
	1/2 Array	IDD6 ₁	VDD1	900		μA
		IDD6 ₂	VDD2	2100		
		IDD6 _{IN}	VDDCA VDDQ	60		
	1/4 Array	IDD6 ₁	VDD1	700		μA
		IDD6 ₂	VDD2	1400		
		IDD6 _{IN}	VDDCA VDDQ	60		
	1/8 Array	IDD6 ₁	VDD1	500		μA
		IDD6 ₂	VDD2	1100		
		IDD6 _{IN}	VDDCA VDDQ	60		

Notes:

- LPDDR2-S4 SDRAM uses the same PASR scheme & IDD6 current value categorization as LPDDR (JESD209).
- LPDDR2-S4 SDRAM devices support both bank-masking & segment-masking. The IDD6 currents are measured using bank-masking only.
- IDD values published are the maximum of the distribution of the arithmetic mean.

8.4 Clock Specification

The jitter specified is a random jitter meeting a Gaussian distribution. Input clocks violating the min/max values may result in malfunction of the LPDDR2 device.

8.4.1 Definition for tCK(avg) and nCK

tCK(avg) is calculated as the average clock period across any consecutive 200 cycle window, where each clock period is calculated from rising edge to rising edge.

$$tCK(avg) = \left[\sum_{j=1}^N tCK_j \right] / N$$

where $N = 200$

Unit 'tCK(avg)' represents the actual clock average tCK(avg) of the input clock under operation. Unit 'nCK' represents one clock cycle of the input clock, counting the actual clock edges.

tCK(avg) may change by up to ± 1% within a 100 clock cycle window, provided that all jitter and timing specs are met.

8.4.2 Definition for tCK(abs)

tCK(abs) is defined as the absolute clock period, as measured from one rising edge to the next consecutive rising edge.

tCK(abs) is not subject to production test.



8.4.3 Definition for tCH(avg) and tCL(avg)

tCH(avg) is defined as the average high pulse width, as calculated across any consecutive 200 high pulses.

$$tCH(avg) = \left[\sum_{j=1}^N tCH_j \right] / (N \times tCK(avg))$$

where $N = 200$

tCL(avg) is defined as the average low pulse width, as calculated across any consecutive 200 low pulses.

$$tCL(avg) = \left[\sum_{j=1}^N tCL_j \right] / (N \times tCK(avg))$$

where $N = 200$

8.4.4 Definition for tJIT(per)

tJIT(per) is the single period jitter defined as the largest deviation of any signal tCK from tCK(avg).

tJIT(per) = Min/max of {tCK_i - tCK(avg) where i = 1 to 200}.

tJIT(per)_{act} is the actual clock jitter for a given system.

tJIT(per)_{allowed} is the specified allowed clock period jitter.

tJIT(per) is not subject to production test.

8.4.5 Definition for tJIT(cc)

tJIT(cc) is defined as the absolute difference in clock period between two consecutive clock cycles.

tJIT(cc) = Max of |{tCK_{i+1} - tCK_i}|.

tJIT(cc) defines the cycle to cycle jitter.

tJIT(cc) is not subject to production test.

8.4.6 Definition for tERR(nper)

tERR(nper) is defined as the cumulative error across n multiple consecutive cycles from tCK(avg).

tERR(nper)_{act} is the actual clock jitter over n cycles for a given system.

tERR(nper)_{allowed} is the specified allowed clock period jitter over n cycles.

tERR(nper) is not subject to production test.

$$tERR(nper) = \left[\sum_{j=i}^{i+n-1} tCK_j \right] - n \times tCK(avg)$$

tERR(nper)_{min} can be calculated by the formula shown below:

$$tERR(nper)_{min} = (1 + 0.68LN(n)) \times tJIT(per)_{min}$$

tERR(nper)_{max} can be calculated by the formula shown below:

$$tERR(nper)_{max} = (1 + 0.68LN(n)) \times tJIT(per)_{max}$$

Using these equations, tERR(nper) tables can be generated for each tJIT(per)_{act} value.



8.4.7 Definition for Duty Cycle Jitter tJIT(duty)

tJIT(duty) is defined with absolute and average specification of tCH / tCL.

$$tJIT(duty),min = MIN((tCH(abs),min - tCH(avg),min), (tCL(abs),min - tCL(avg),min)) \times tCK(avg)$$

$$tJIT(duty),max = MAX((tCH(abs),max - tCH(avg),max), (tCL(abs),max - tCL(avg),max)) \times tCK(avg)$$

8.4.8 Definition for tCK(abs), tCH(abs) and tCL(abs)

These parameters are specified per their average values, however it is understood that the following relationship between the average timing and the absolute instantaneous timing holds at all times.

Table of Definition for tCK(abs), tCH(abs), and tCL(abs)

Parameter	Symbol	Min	Unit
Absolute Clock Period	tCK(abs)	tCK(avg),min + tJIT(per),min	pS
Absolute Clock HIGH Pulse Width	tCH(abs)	tCH(avg),min + tJIT(duty),min / tCK(avg)min	tCK(avg)
Absolute Clock LOW Pulse Width	tCL(abs)	tCL(avg),min + tJIT(duty),min / tCK(avg)min	tCK(avg)

Notes:

1. tCK(avg),min is expressed in pS for this table.
2. tJIT(duty),min is a negative value.

8.5 Period Clock Jitter

LPDDR2 devices can tolerate some clock period jitter without core timing parameter de-rating. This section describes device timing requirements in the presence of clock period jitter (tJIT(per)) in excess of the values found in section 8.7.1 “LPDDR2 AC Timing” table and how to determine cycle time de-rating and clock cycle de-rating.

8.5.1 Clock Period Jitter Effects on Core Timing Parameters (tRCD, tRP, tRTP, tWR, tWRA, tWTR, tRC, tRAS, tRRD, tFAW)

Core timing parameters extend across multiple clock cycles. Period clock jitter will impact these parameters when measured in numbers of clock cycles. When the device is operated with clock jitter within the specification limits, the LPDDR2 device is characterized and verified to support $t_{nPARAM} = RU\{t_{PARAM} / tCK(avg)\}$.

When the device is operated with clock jitter outside specification limits, the number of clocks or tCK(avg) may need to be increased based on the values for each core timing parameter.

8.5.1.1 Cycle Time De-rating for Core Timing Parameters

For a given number of clocks (tnPARAM), for each core timing parameter, average clock period (tCK(avg)) and actual cumulative period error (tERR(tnPARAM),act) in excess of the allowed cumulative period error (tERR(tnPARAM),allowed), the equation below calculates the amount of cycle time de-rating (in nS) required if the equation results in a positive value for a core timing parameter (tCORE).

$$CycleTimeDerating = MAX \left\{ \left(\frac{t_{PARAM} + tERR(tnPARAM),act - tERR(tnPARAM),allowed}{tnPARAM} - tCK(avg) \right), 0 \right\}$$

A cycle time derating analysis should be conducted for each core timing parameter. The amount of cycle time derating required is the maximum of the cycle time de-ratings determined for each individual core timing parameter.



8.5.1.2 Clock Cycle De-rating for Core Timing Parameters

For a given number of clocks (t_{nPARAM}) for each core timing parameter, clock cycle de-rating should be specified with amount of period jitter ($t_{JIT(per)}$).

For a given number of clocks (t_{nPARAM}), for each core timing parameter, average clock period ($t_{CK(avg)}$) and actual cumulative period error ($t_{ERR}(t_{nPARAM},act)$) in excess of the allowed cumulative period error ($t_{ERR}(t_{nPARAM},allowed)$), the equation below calculates the clock cycle derating (in clocks) required if the equation results in a positive value for a core timing parameter (t_{CORE}).

$$ClockCycleDerating = RU \left\{ \frac{t_{PARAM} + t_{ERR}(t_{nPARAM},act) - t_{ERR}(t_{nPARAM},allowed)}{t_{CK(avg)}} \right\} - t_{nPARAM}$$

A clock cycle de-rating analysis should be conducted for each core timing parameter.

8.5.2 Clock Jitter Effects on Command/Address Timing Parameters (t_{IS} , t_{IH} , t_{ISCKE} , t_{IHCKE} , t_{ISb} , t_{IHb} , t_{ISCKEb} , t_{IHCKEb})

These parameters are measured from a command/address signal (CKE, CS, CA0 - CA9) transition edge to its respective clock signal (CK_t/CK_c) crossing. The spec values are not affected by the amount of clock jitter applied (i.e. $t_{JIT(per)}$), as the setup and hold are relative to the clock signal crossing that latches the command/address. Regardless of clock jitter values, these values shall be met.

8.5.3 Clock Jitter Effects on Read tTiming Parameters

8.5.3.1 t_{RPRE}

When the device is operated with input clock jitter, t_{RPRE} needs to be de-rated by the actual period jitter ($t_{JIT(per),act,max}$) of the input clock in excess of the allowed period jitter ($t_{JIT(per),allowed,max}$). Output de-ratings are relative to the input clock.

$$t_{RPRE}(min, derated) = 0.9 - \left(\frac{t_{JIT(per),act,max} - t_{JIT(per),allowed,max}}{t_{CK(avg)}} \right)$$

For example,

if the measured jitter into a LPDDR2-800 device has $t_{CK(avg)} = 2500$ pS, $t_{JIT(per),act,min} = -172$ pS and $t_{JIT(per),act,max} = +193$ pS, then

$t_{RPRE,min,derated} = 0.9 - (t_{JIT(per),act,max} - t_{JIT(per),allowed,max})/t_{CK(avg)} = 0.9 - (193 - 100)/2500 = .8628 t_{CK(avg)}$

8.5.3.2 $t_{LZ(DQ)}$, $t_{HZ(DQ)}$, t_{DQSCK} , $t_{LZ(DQS)}$, $t_{HZ(DQS)}$

These parameters are measured from a specific clock edge to a data signal (DMn, DQm.: n=0,1,2,3. m=0-31) transition and will be met with respect to that clock edge. Therefore, they are not affected by the amount of clock jitter applied (i.e. $t_{JIT(per)}$).

8.5.3.3 t_{QSH} , t_{QSL}

These parameters are affected by duty cycle jitter which is represented by $t_{CH(abs)min}$ and $t_{CL(abs)min}$.

$t_{QSH(abs)min} = t_{CH(abs)min} - 0.05$

$t_{QSL(abs)min} = t_{CL(abs)min} - 0.05$

These parameters determine absolute Data-Valid window at the LPDDR2 device pin.

Absolute min data-valid window @ LPDDR2 device pin =

$\min \{ (t_{QSH(abs)min} * t_{CK(avg)min} - t_{DQSQmax} - t_{QHSmax}), (t_{QSL(abs)min} * t_{CK(avg)min} - t_{DQSQmax} - t_{QHSmax}) \}$

This minimum data-valid window shall be met at the target frequency regardless of clock jitter.



8.5.3.4 trPST

trPST is affected by duty cycle jitter which is represented by tCL(abs). Therefore trPST(abs)min can be specified by tCL(abs)min.

$$\text{trPST}(\text{abs})_{\text{min}} = \text{tCL}(\text{abs})_{\text{min}} - 0.05 = \text{tQSL}(\text{abs})_{\text{min}}$$

8.5.4 Clock Jitter Effects on Write Timing Parameters

8.5.4.1 tDS, tDH

These parameters are measured from a data signal (DMn, DQm.: n=0,1,2,3. m=0–31) transition edge to its respective data strobe signal (DQSn_t, DQSn_c: n=0,1,2,3) crossing. The spec values are not affected by the amount of clock jitter applied (i.e. tJIT(per), as the setup and hold are relative to the clock signal crossing that latches the command/address. Regardless of clock jitter values, these values shall be met.

8.5.4.2 tDSS, tDSH

These parameters are measured from a data strobe signal (DQSx_t, DQSx_c) crossing to its respective clock signal (CK_t/CK_c) crossing. The spec values are not affected by the amount of clock jitter applied (i.e. tJIT(per), as the setup and hold are relative to the clock signal crossing that latches the command/address. Regardless of clock jitter values, these values shall be met.

8.5.4.3 tDQSS

This parameter is measured from a data strobe signal (DQSx_t, DQSx_c) crossing to the subsequent clock signal (CK_t/CK_c) crossing. When the device is operated with input clock jitter, this parameter needs to be de-rated by the actual period jitter tJIT(per),act of the input clock in excess of the allowed period jitter tJIT(per),allowed.

$$tDQSS(\text{min, derated}) = 0.75 - \frac{tJIT(\text{per}), \text{act}, \text{min} - tJIT(\text{per}), \text{allowed}, \text{min}}{tCK(\text{avg})}$$

$$tDQSS(\text{max, derated}) = 1.25 - \frac{tJIT(\text{per}), \text{act}, \text{max} - tJIT(\text{per}), \text{allowed}, \text{max}}{tCK(\text{avg})}$$

For example,

if the measured jitter into a LPDDR2-800 device has tCK(avg) = 2500 pS, tJIT(per),act,min = -172 pS and tJIT(per),act,max = + 193 pS, then

$$tDQSS(\text{min, derated}) = 0.75 - (tJIT(\text{per}), \text{act}, \text{min} - tJIT(\text{per}), \text{allowed}, \text{min}) / tCK(\text{avg}) = 0.75 - (-172 + 100) / 2500 = .7788 tCK(\text{avg})$$

and

$$tDQSS(\text{max, derated}) = 1.25 - (tJIT(\text{per}), \text{act}, \text{max} - tJIT(\text{per}), \text{allowed}, \text{max}) / tCK(\text{avg}) = 1.25 - (193 - 100) / 2500 = 1.2128 tCK(\text{avg})$$



8.6 Refresh Requirements

8.6.1 Refresh Requirement Parameters

Parameter		Symbol	2 Gb	Unit
Number of Banks			8	
Refresh Window TCASE ≤ 85°C		tREFW	32	mS
Required number of REFRESH commands (min)		R	8,192	
Average time between REFRESH commands (for reference only) TCASE ≤ 85°C	REFab	tREFI	3.9	μS
	REFpb	tREFIpb	0.4875	μS
Refresh Cycle time		tRFCab	130	nS
Per Bank Refresh Cycle time		tRFCpb	60	nS
Burst Refresh Window = 4 x 8 x tRFCab		tREFBW	4.16	μS



8.7 AC Timings

8.7.1 LPDDR2 AC Timing

(Note 6 apply to the entire table)

Parameter	Symbol	min / max	min tCK	Data Rate					Unit
				800	667	533	400	333	
Max. Frequency ⁴		~		400	333	266	200	166	MHz
Clock Timing									
Average Clock Period	tCK(avg)	MIN		2.5	3	3.75	5	6	ns
		MAX		100					
Average high pulse width	tCH(avg)	MIN		0.45					tCK(avg)
		MAX		0.55					
Average low pulse width	tCL(avg)	MIN		0.45					tCK(avg)
		MAX		0.55					
Absolute Clock Period	tCK(abs)	MIN		tCK(avg)min + tJIT(per)min					ps
Absolute clock HIGH pulse width (with allowed jitter)	tCH(abs), allowed	MAX		0.43					tCK(avg)
		MIN		0.57					
Absolute clock LOW pulse width (with allowed jitter)	tCL(abs), (allowed)	MAX		0.43					tCK(avg)
		MIN		0.57					
Clock Period Jitter (with allowed jitter)	tJIT(per), (allowed)	MIN		-100	-110	-120	-140	-150	ps
		MAX		100	110	120	140	150	
Maximum Clock Jitter between two consecutive clock cycles (with allowed jitter)	tJIT(cc), allowed	MAX		200	220	240	280	300	ps
Duty cycle Jitter (with allowed jitter)	tJIT(duty), allowed	MIN		MIN ((tCH(abs),min - tCH(avg),min), (tCL(abs),min - tCL(avg),min)) * tCK(avg)					ps
		MAX		MAX ((tCH(abs),max - tCH(avg),max), (tCL(abs),max - tCL(avg),max)) * tCK(avg)					ps
Cumulative error across 2 cycles	tERR(2per), (allowed)	MIN		-147	-162	-177	-206	-221	ps
		MAX		147	162	177	206	221	
Cumulative error across 3 cycles	tERR(3per), (allowed)	MIN		-175	-192	-210	-245	-262	ps
		MAX		175	192	210	245	262	
Cumulative error across 4 cycles	tERR(4per), (allowed)	MIN		-194	-214	-233	-272	-291	ps
		MAX		194	214	233	272	291	
Cumulative error across 5 cycles	tERR(5per), (allowed)	MIN		-209	-230	-251	-293	-314	ps
		MAX		209	230	251	293	314	
Cumulative error across 6 cycles	tERR(6per), (allowed)	MIN		-222	-244	-266	-311	-333	ps
		MAX		222	244	266	311	333	
Cumulative error across 7 cycles	tERR(7per), (allowed)	MIN		-232	-256	-279	-325	-348	ps
		MAX		232	256	279	325	348	
Cumulative error across 8 cycles	tERR(8per), (allowed)	MIN		-241	-266	-290	-338	-362	ps
		MAX		241	266	290	338	362	
Cumulative error across 9 cycles	tERR(9per), (allowed)	MIN		-249	-274	-299	-349	-374	ps
		MAX		249	274	299	349	374	
Cumulative error across 10 cycles	tERR(10per), (allowed)	MIN		-257	-282	-308	-359	-385	ps
		MAX		257	282	308	359	385	
Cumulative error across 11 cycles	tERR(11per), (allowed)	MIN		-263	-289	-316	-368	-395	ps
		MAX		263	289	316	368	395	
Cumulative error across 12 cycles	tERR(12per), (allowed)	MIN		-269	-296	-323	-377	-403	ps
		MAX		269	296	323	377	403	
Cumulative error across n = 13, 14 . . . 49, 50 cycles	tERR(nper), (allowed)	MIN		tERR(nper),allowed,min = (1 + 0.68ln(n)) * tJIT(per),allowed,min					ps
		MAX		tERR(nper),allowed,max = (1 + 0.68ln(n)) * tJIT(per),allowed,max					



Parameter	Symbol	min / max	min tCK	Data Rate					Unit
				800	667	533	400	333	
ZQ Calibration Parameters									
Initialization Calibration Time	tZQINIT	MIN		1					µs
Full Calibration Time	tZQCL	MIN	6	360					ns
Short Calibration Time	tZQCS	MIN	6	90					ns
Calibration Reset Time	tZQRESET	MIN	3	50					ns
Read Parameters^{*11}									
DQS output access time from CK_t/CK_c	tDQSCK	MIN		2500					ps
		MAX		5500					
DQSCK Delta Short ^{*15}	tDQSCKDS	MAX		450	540	670	900	1080	ps
DQSCK Delta Medium ^{*16}	tDQSCKDM	MAX		900	1050	1350	1800	1900	ps
DQSCK Delta Long ^{*17}	tDQSCKDL	MAX		1200	1400	1800	2400	-	ps
DQS - DQ skew	tDQSQ	MAX		240	280	340	400	500	ps
Data hold skew factor	tQHS	MAX		280	340	400	480	600	ps
DQS Output High Pulse Width	tQSH	MIN		tCH(abs) - 0.05					tCK(avg)
DQS Output Low Pulse Width	tQSL	MIN		tCL(abs) - 0.05					tCK(avg)
Data Half Period	tQHP	MIN		min(tQSH, tQSL)					tCK(avg)
DQ / DQS output hold time from DQS	tQH	MIN		tQHP - tQHS					ps
Read preamble ^{*12,*13}	tRPRE	MIN		0.9					tCK(avg)
Read postamble ^{*12,*14}	tRPST	MIN		tCL(abs) - 0.05					tCK(avg)
DQS low-Z from clock ^{*12}	tLZ(DQS)	MIN		tDQSCK(MIN) - 300					ps
DQ low-Z from clock ^{*12}	tLZ(DQ)	MIN		tDQSCK(MIN) - (1.4 * tQHS(MAX))					ps
DQS high-Z from clock ^{*12}	tHZ(DQS)	MAX		tDQSCK(MAX) - 100					ps
DQ high-Z from clock ^{*12}	tHZ(DQ)	MAX		tDQSCK(MAX) + (1.4 * tDQSQ(MAX))					ps
Write Parameters^{*11}									
DQ and DM input hold time (Vref based)	tDH	MIN		270	350	430	480	600	ps
DQ and DM input setup time (Vref based)	tDS	MIN		270	350	430	480	600	ps
DQ and DM input pulse width	tDIPW	MIN		0.35					tCK(avg)
Write command to 1st DQS latching transition	tDQSS	MIN		0.75					tCK(avg)
		MAX		1.25					
DQS input high-level width	tDQSH	MIN		0.4					tCK(avg)
DQS input low-level width	tDQSL	MIN		0.4					tCK(avg)
DQS falling edge to CK setup time	tDSS	MIN		0.2					tCK(avg)
DQS falling edge hold time from CK	tDSH	MIN		0.2					tCK(avg)
Write postamble	tWPST	MIN		0.4					tCK(avg)
Write preamble	tWPRE	MIN		0.35					tCK(avg)
CKE Input Parameters									
CKE min. pulse width (high and low pulse width)	tCKE	MIN	3	3					tCK(avg)
CKE input setup time	tISCKE ^{*2}	MIN		0.25					tCK(avg)
CKE input hold time	tIHCKE ^{*3}	MIN		0.25					tCK(avg)



Parameter	Symbol	min / max	min tCK	Data Rate					Unit
				800	667	533	400	333	
Command Address Input Parameters^{*11}									
Address and control input setup time (Vref based)	tIS ^{*1}	MIN		290	370	460	600	740	ps
Address and control input hold time (Vref based)	tIH ^{*1}	MIN		290	370	460	600	740	ps
Address and control input pulse width	tIPW	MIN		0.40					tCK(avg)
Boot Parameters (10 MHz - 55 MHz)^{*5, 7, 8}									
Clock Cycle Time	tCKb	MAX		100					ns
		MIN		18					
CKE Input Setup Time	tISCKEb	MIN		2.5					ns
CKE Input Hold Time	tHCKEb	MIN		2.5					ns
Address & Control Input Setup Time	tISb	MIN		1150					ps
Address & Control Input Hold Time	tIHb	MIN		1150					ps
DQS Output Data Access Time from CK_t/CK_c	tDQSCKb	MIN		2.0					ns
		MAX		10.0					
Data Strobe Edge to Output Data Edge tDQSQb - 1.2	tDQSQb	MAX		1.2					ns
Data Hold Skew Factor	tQHSb	MAX		1.2					ns
Mode Register Parameters									
MODE REGISTER Write command period	tMRW	MIN	5	5					tCK(avg)
Mode Register Read command period	tMRR	MIN	2	2					tCK(avg)
LPDDR2 SDRAM Core Parameters^{*9}									
Read Latency	RL	MIN	3	6	5	4	3	3	tCK(avg)
Write Latency	WL	MIN	1	3	2	2	1	1	tCK(avg)
ACTIVE to ACTIVE command period	tRC	MIN		tRAS + tRPab (with all-bank Precharge) tRAS + tRPpb (with per-bank Precharge)					ns
CKE min. pulse width during Self-Refresh (low pulse width during Self-Refresh)	tCKESR	MIN	3	15					ns
Self refresh exit to next valid command delay	tXSR	MIN	2	tRFCab + 10					ns
Exit power down to next valid command delay	tXP	MIN	2	7.5					ns
LPDDR2-S4 CAS to CAS delay	tCCD	MIN	2	2					tCK(avg)
Internal Read to Precharge command delay	tRTP	MIN	2	7.5					ns
RAS to CAS Delay	tRCD	Typ	3	18					ns
Row Precharge Time (single bank)	tRPpb	Typ	3	18					ns
Row Precharge Time (all banks)	tRPab 8-bank	Typ	3	21					ns
Row Active Time	tRAS	MIN	3	42					ns
		MAX	-	70					µs
Write Recovery Time	tWR	MIN	3	15					ns
Internal Write to Read Command Delay	tWTR	MIN	2	7.5			10		ns
Active bank A to Active bank B	tRRD	MIN	2	10					ns
Four Bank Activate Window	tFAW	MIN	8	50				60	ns
Minimum Deep Power Down Time	tDPD	MIN		500					µs



Parameter	Symbol	min / max	min tCK	Data Rate					Unit
				800	667	533	400	333	
LPDDR2 Temperature De-Rating									
tDQSCK De-Rating	tDQSCK (Derated)	MAX		6000					ps
Core Timings Temperature De-Rating	tRCD (Derated)	MIN		tRCD + 1.875					ns
	tRC (Derated)	MIN		tRC + 1.875					ns
	tRAS (Derated)	MIN		tRAS + 1.875					ns
	tRP (Derated)	MIN		tRP + 1.875					ns
	tRRD (Derated)	MIN		tRRD + 1.875					ns

Notes:

- Input set-up/hold time for signal (CA[0:n], CS_n).
- CKE input setup time is measured from CKE reaching high/low voltage level to CK_t/CK_c crossing.
- CKE input hold time is measured from CK_t/CK_c crossing to CKE reaching high/low voltage level.
- Frequency values are for reference only. Clock cycle time (tCK) shall be used to determine device capabilities.
- To guarantee device operation before the LPDDR2 device is configured a number of AC boot timing parameters are defined in this table. Boot parameter symbols have the letter b appended, e.g. tCK during boot is tCKb.
- Frequency values are for reference only. Clock cycle time (tCK or tCKb) shall be used to determine device capabilities.
- The SDRAM will set some Mode register default values upon receiving a RESET (MRW) command as specified in "Mode Register Definition".
- The output skew parameters are measured with Ron default settings into the reference load.
- The min tCK column applies only when tCK is greater than 6nS for LPDDR2-S4 devices.
- All AC timings assume an input slew rate of 1V/nS.
- Read, Write, and Input Setup and Hold values are referenced to Vref.
- For low-to-high and high-to-low transitions, the timing reference will be at the point when the signal crosses VTT. tHZ and tLZ transitions occur in the same access time (with respect to clock) as valid data transitions. These parameters are not referenced to a specific voltage level but to the time when the device output is no longer driving (for tRPST, tHZ(DQS) and tHZ(DQ)), or begins driving (for tRPRE, tLZ(DQS), tLZ(DQ)). Below "HSUL_12 Driver Output Reference Load for Timing and Slew Rate" figure shows a method to calculate the point when device is no longer driving tHZ(DQS) and tHZ(DQ), or begins driving tLZ(DQS), tLZ(DQ) by measuring the signal at two different voltages. The actual voltage measurement points are not critical as long as the calculation is consistent.

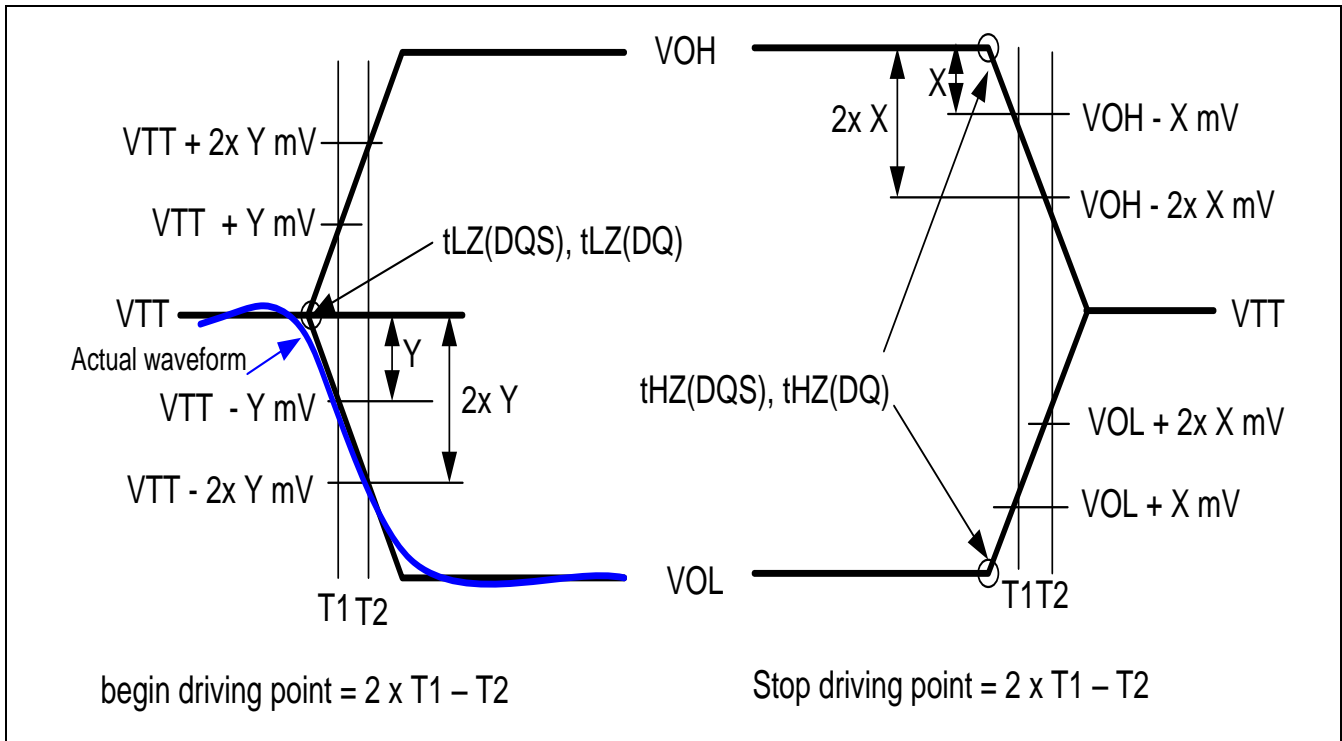

Figure of HSUL_12 Driver Output Reference Load for Timing and Slew Rate

The parameters $tLZ(DQS)$, $tLZ(DQ)$, $tHZ(DQS)$, and $tHZ(DQ)$ are defined as single-ended. The timing parameters $tRPRE$ and $tRPST$ are determined from the differential signal DQS_t - DQS_c .

13. Measured from the start driving of DQS_t - DQS_c to the start driving the first rising strobe edge.
14. Measured from the from start driving the last falling strobe edge to the stop driving DQS_t , DQS_c .
15. $tDQCKDS$ is the absolute value of the difference between any two $tDQCK$ measurements (within a byte lane) within a contiguous sequence of bursts within a 160nS rolling window. $tDQCKDS$ is not tested and is guaranteed by design. Temperature drift in the system is $< 10^\circ\text{C/s}$. Values do not include clock jitter.
16. $tDQCKDM$ is the absolute value of the difference between any two $tDQCK$ measurements (within a byte lane) within a 1.6 μS rolling window. $tDQCKDM$ is not tested and is guaranteed by design. Temperature drift in the system is $< 10^\circ\text{C/s}$. Values do not include clock jitter.
17. $tDQCKDL$ is the absolute value of the difference between any two $tDQCK$ measurements (within a byte lane) within a 32mS rolling window. $tDQCKDL$ is not tested and is guaranteed by design. Temperature drift in the system is $< 10^\circ\text{C/s}$. Values do not include clock jitter.



8.7.2 CA and CS_n Setup, Hold and Derating

For all input signals (CA and CS_n) the total t_{IS} (setup time) and t_{IH} (hold time) required is calculated by adding the data sheet $t_{IS}(\text{base})$ and $t_{IH}(\text{base})$ value (see 8.7.2.1 “CA and CS_n Setup and Hold Base-Values for 1V/nS” table) to the Δt_{IS} and Δt_{IH} derating value (see 8.7.2.2 “Derating Values LPDDR2 t_{IS}/t_{IH} - AC/DC Based AC220” table). Example: $t_{IS}(\text{total setup time}) = t_{IS}(\text{base}) + \Delta t_{IS}$.

Setup (t_{IS}) nominal slew rate for a rising signal is defined as the slew rate between the last crossing of $V_{REF}(\text{dc})$ and the first crossing of $V_{IH}(\text{ac})_{\text{min}}$. Setup (t_{IS}) nominal slew rate for a falling signal is defined as the slew rate between the last crossing of $V_{REF}(\text{dc})$ and the first crossing of $V_{IL}(\text{ac})_{\text{max}}$. If the actual signal is always earlier than the nominal slew rate line between shaded ‘ $V_{REF}(\text{dc})$ to ac region’, use nominal slew rate for derating value (see 8.7.2.4 “Nominal Slew Rate and t_{VAC} for Setup Time t_{IS} for CA and CS_n with Respect to Clock” figure). If the actual signal is later than the nominal slew rate line anywhere between shaded ‘ $V_{REF}(\text{dc})$ to ac region’, the slew rate of a tangent line to the actual signal from the ac level to dc level is used for derating value (see 8.7.2.6 “Tangent Line for Setup Time t_{IS} for CA and CS_n with Respect to Clock” figure).

Hold (t_{IH}) nominal slew rate for a rising signal is defined as the slew rate between the last crossing of $V_{IL}(\text{dc})_{\text{max}}$ and the first crossing of $V_{REF}(\text{dc})$. Hold (t_{IH}) nominal slew rate for a falling signal is defined as the slew rate between the last crossing of $V_{IH}(\text{dc})_{\text{min}}$ and the first crossing of $V_{REF}(\text{dc})$. If the actual signal is always later than the nominal slew rate line between shaded ‘dc to $V_{REF}(\text{dc})$ region’, use nominal slew rate for derating value (see 8.7.2.5 “Nominal Slew Rate for Hold Time t_{IH} for CA and CS_n with Respect to Clock” figure). If the actual signal is earlier than the nominal slew rate line anywhere between shaded ‘dc to $V_{REF}(\text{dc})$ region’, the slew rate of a tangent line to the actual signal from the dc level to $V_{REF}(\text{dc})$ level is used for derating value (see 8.7.2.7 “Tangent Line for Hold Time t_{IH} for CA and CS_n with Respect to Clock” figure).

For a valid transition the input signal has to remain above/below $V_{IH}/I_{L}(\text{ac})$ for some time t_{VAC} (see 8.7.2.3 “Required Time t_{VAC} above $V_{IH}(\text{ac})$ {below $V_{IL}(\text{ac})$ } for Valid Transition” table).

Although for slow slew rates the total setup time might be negative (i.e. a valid input signal will not have reached $V_{IH}/I_{L}(\text{ac})$ at the time of the rising clock transition) a valid input signal is still required to complete the transition and reach $V_{IH}/I_{L}(\text{ac})$.

For slew rates in between the values listed in 8.7.2.2 “Derating Values LPDDR2 t_{IS}/t_{IH} - AC/DC Based AC220” table, the derating values may obtained by linear interpolation. These values are typically not subject to production test. They are verified by design and characterization.

8.7.2.1 CA and CS_n Setup and Hold Base-Values for 1V/nS

Unit [ps]	LPDDR2-800	reference
$t_{IS}(\text{base})$	70	$V_{IH/L}(\text{ac}) = V_{REF}(\text{dc}) \pm 220\text{mV}$
$t_{IH}(\text{base})$	160	$V_{IH/L}(\text{dc}) = V_{REF}(\text{dc}) \pm 130\text{mV}$

Note: ac/dc referenced for 1V/nS CA and CS_n slew rate and 2V/nS differential CK_t-CK_c slew rate.



8.7.2.2 Derating Values LPDDR2 tIS/tIH - AC/DC Based AC220

Δt_{IS} , Δt_{IH} derating in [pS] AC/DC based AC220 Threshold -> $V_{IH(ac)}=V_{REF(dc)}+220mV$, $V_{IL(ac)}=V_{REF(dc)}-220mV$ DC130 Threshold -> $V_{IH(dc)}=V_{REF(dc)}+130mV$, $V_{IL(dc)}=V_{REF(dc)}-130mV$																
CA, CS_n Slew Rate V/nS	CK_t,CK_c Differential Slew Rate															
	4.0 V/nS		3.0 V/nS		2.0 V/nS		1.8 V/nS		1.6 V/nS		1.4 V/nS		1.2 V/nS		1.0 V/nS	
	Δt_{IS}	Δt_{IH}	Δt_{IS}	Δt_{IH}	Δt_{IS}	Δt_{IH}	Δt_{IS}	Δt_{IH}	Δt_{IS}	Δt_{IH}	Δt_{IS}	Δt_{IH}	Δt_{IS}	Δt_{IH}	Δt_{IS}	Δt_{IH}
2.0	110	65	110	65	110	65	-	-	-	-	-	-	-	-	-	-
1.5	74	43	73	43	73	43	89	59	-	-	-	-	-	-	-	-
1.0	0	0	0	0	0	0	16	16	32	32	-	-	-	-	-	-
0.9	-	-	-3	-5	-3	-5	13	11	29	27	45	43	-	-	-	-
0.8	-	-	-	-	-8	-13	8	3	24	19	40	35	56	55	-	-
0.7	-	-	-	-	-	-	2	-6	18	10	34	26	50	46	66	78
0.6	-	-	-	-	-	-	-	-	10	-3	26	13	42	33	58	65
0.5	-	-	-	-	-	-	-	-	-	-	4	-4	20	16	36	48
0.4	-	-	-	-	-	-	-	-	-	-	-	-	-7	2	17	34

Note: Cell contents '-' are defined as not supported.

8.7.2.3 Required Time tVAC above VIH(ac) {below VIL(ac)} for Valid Transition

Slew Rate [V/nS]	tVAC @ 220mV [pS]	
	min	max
> 2.0	175	-
2.0	170	-
1.5	167	-
1.0	163	-
0.9	162	-
0.8	161	-
0.7	159	-
0.6	155	-
0.5	150	-
<0.5	150	-



8.7.2.4 Nominal Slew Rate and tVAC for Setup Time tIS for CA and CS_n with Respect to Clock

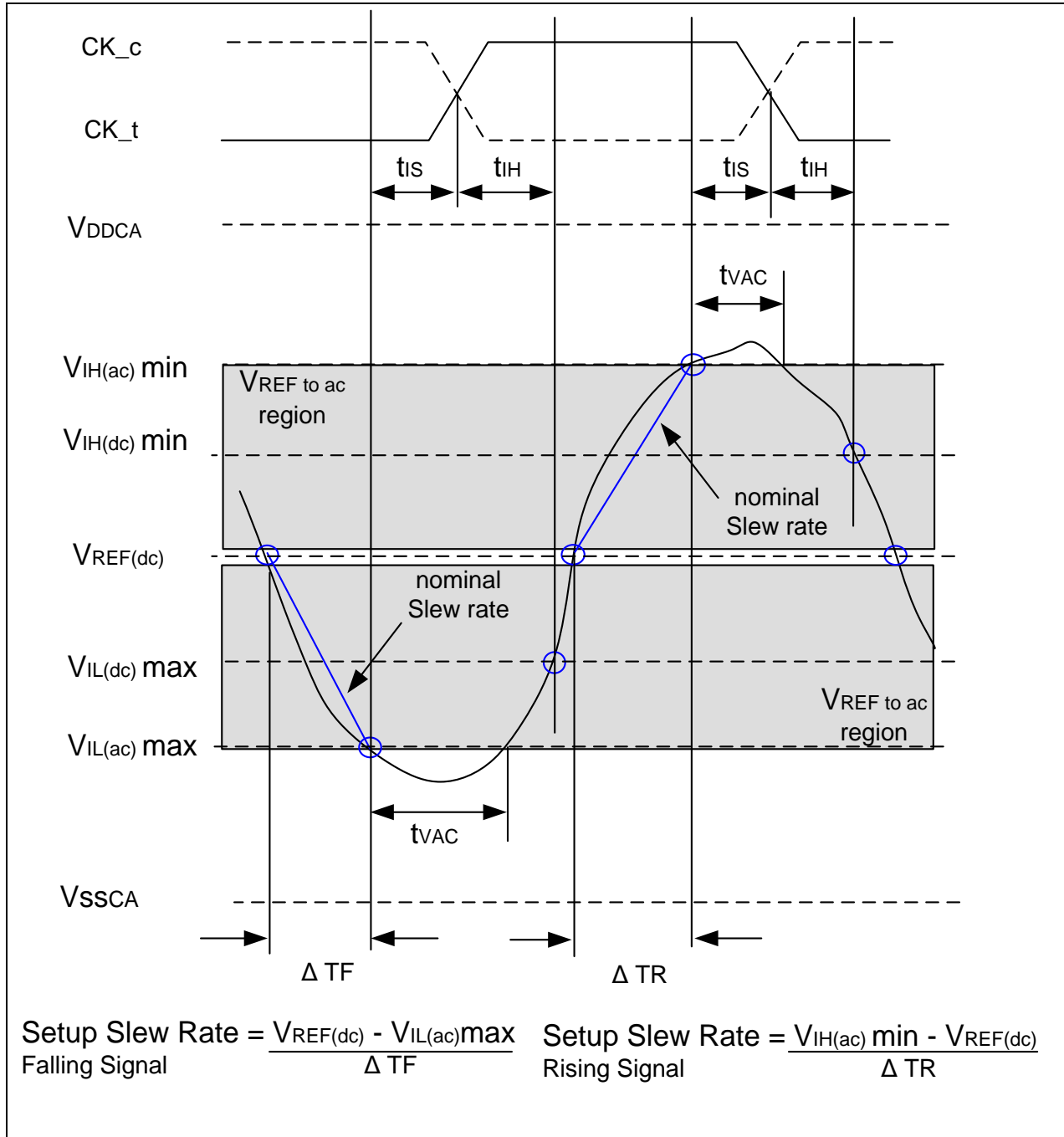



8.7.2.5 Nominal Slew Rate for Hold Time t_H for CA and CS_n with Respect to Clock

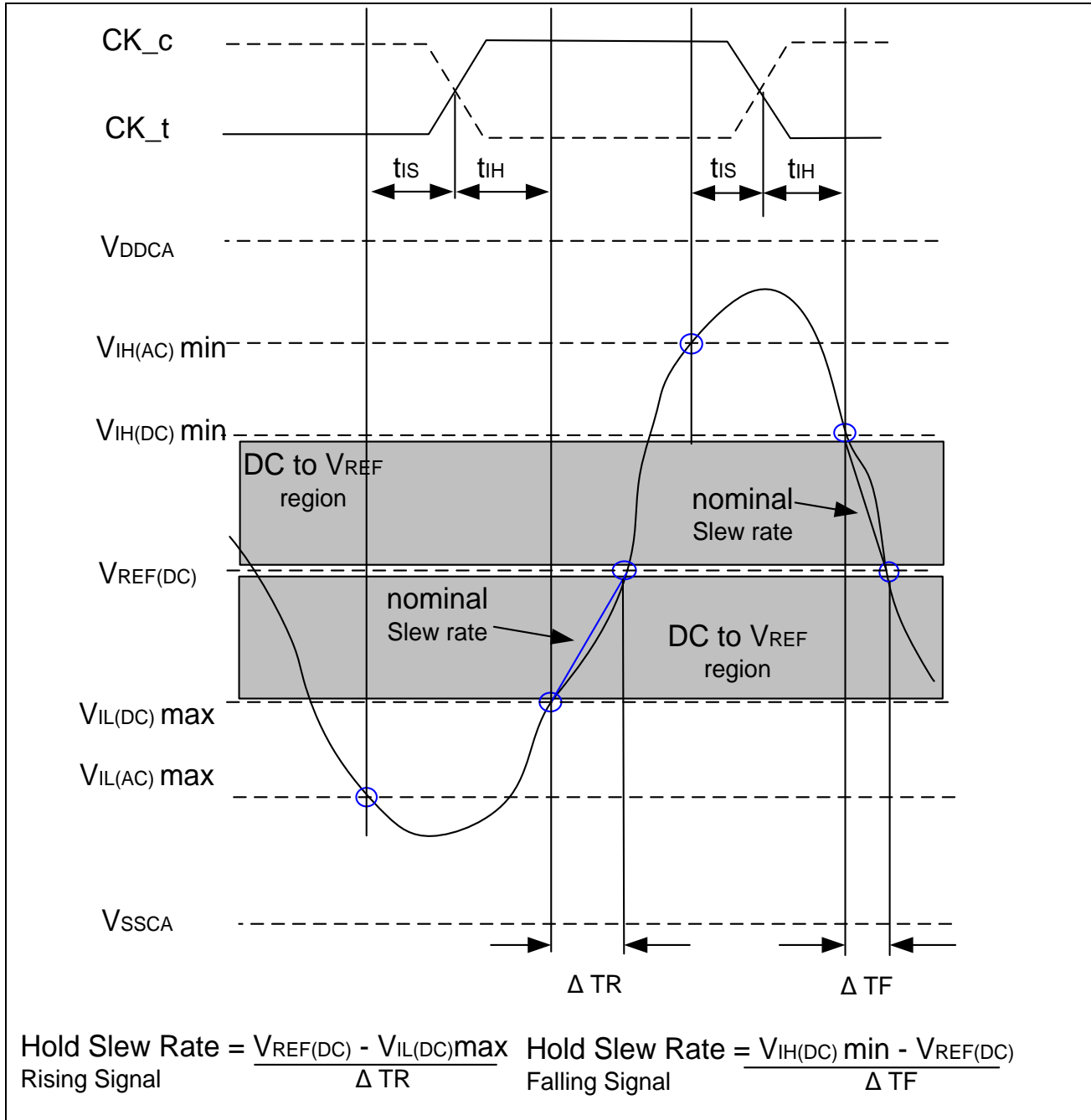



8.7.2.6 Tangent Line for Setup Time t_{IS} for CA and CS_n with Respect to Clock

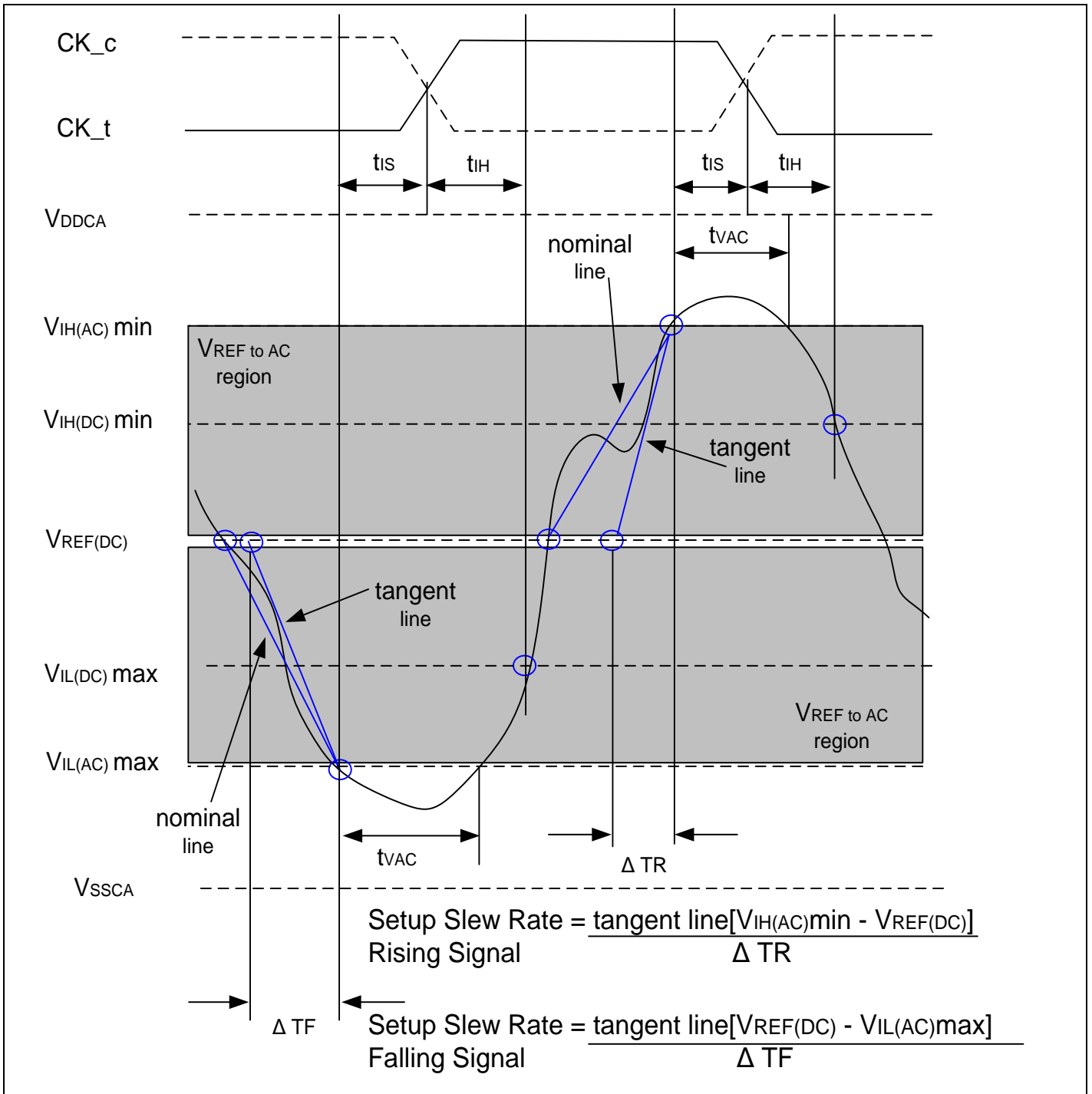



8.7.2.7 Tangent Line for Hold Time t_H for CA and CS_n with Respect to Clock

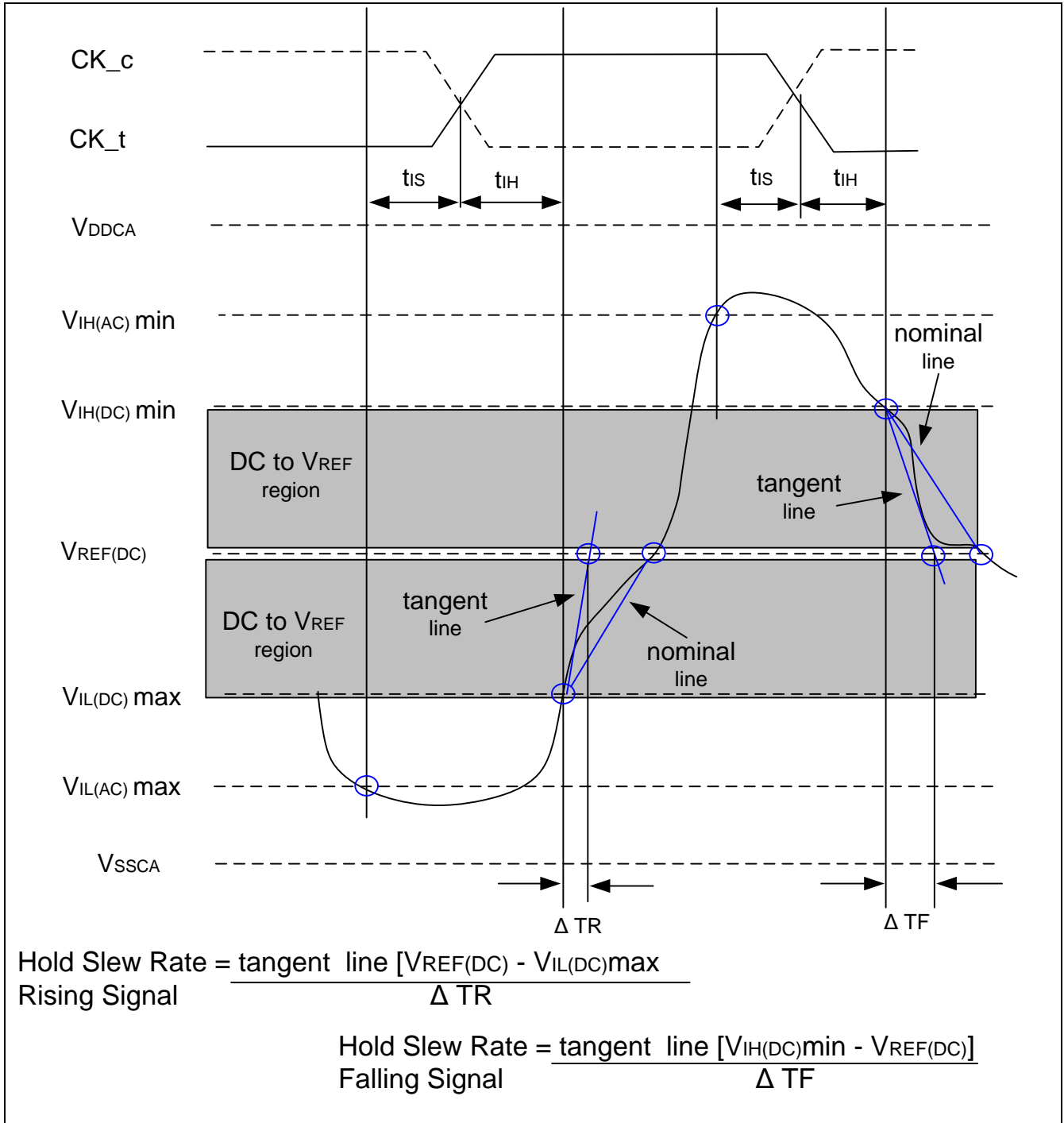



8.7.3 Data Setup, Hold and Slew Rate Derating

For all input signals (DQ, DM) the total tDS (setup time) and tDH (hold time) required is calculated by adding the data sheet tDS(base) and tDH(base) value (see 8.7.3.1 “Data Setup and Hold Base-Values” table) to the Δt_{DS} and Δt_{DH} (see 8.7.3.2 “Derating Values LPDDR2 tDS/tDH - AC/DC Based AC220” table) derating value respectively. Example: tDS (total setup time) = tDS(base) + Δt_{DS} .

Setup (tDS) nominal slew rate for a rising signal is defined as the slew rate between the last crossing of $V_{REF(dc)}$ and the first crossing of $V_{IH(ac)min}$. Setup (tDS) nominal slew rate for a falling signal is defined as the slew rate between the last crossing of $V_{REF(dc)}$ and the first crossing of $V_{IL(ac)max}$ (see 8.7.3.4 “Nominal Slew Rate and tVAC for Setup Time tDS for DQ with Respect to Strobe” figure). If the actual signal is always earlier than the nominal slew rate line between shaded ‘ $V_{REF(dc)}$ to ac region’, use nominal slew rate for derating value. If the actual signal is later than the nominal slew rate line anywhere between shaded ‘ $V_{REF(dc)}$ to ac region’, the slew rate of a tangent line to the actual signal from the ac level to dc level is used for derating value (see 8.7.3.6 “Tangent Line for Setup Time tDS for DQ with Respect to Strobe” figure).

Hold (tDH) nominal slew rate for a rising signal is defined as the slew rate between the last crossing of $V_{IL(dc)max}$ and the first crossing of $V_{REF(dc)}$. Hold (tDH) nominal slew rate for a falling signal is defined as the slew rate between the last crossing of $V_{IH(dc)min}$ and the first crossing of $V_{REF(dc)}$ (see 8.7.3.5 “Nominal Slew Rate for Hold time tDH for DQ with Respect to Strobe” figure). If the actual signal is always later than the nominal slew rate line between shaded ‘dc level to $V_{REF(dc)}$ region’, use nominal slew rate for derating value. If the actual signal is earlier than the nominal slew rate line anywhere between shaded ‘dc to $V_{REF(dc)}$ region’, the slew rate of a tangent line to the actual signal from the dc level to $V_{REF(dc)}$ level is used for derating value (see 8.7.3.7 “Tangent Line for Hold Time tDH for DQ with Respect to Strobe” figure).

For a valid transition the input signal has to remain above/below $V_{IH/IL(ac)}$ for some time tVAC (see 8.7.3.3 “Required Time tVAC above $V_{IH(ac)}$ {below $V_{IL(ac)}$ } for Valid Transition” table).

Although for slow slew rates the total setup time might be negative (i.e. a valid input signal will not have reached $V_{IH/IL(ac)}$ at the time of the rising clock transition) a valid input signal is still required to complete the transition and reach $V_{IH/IL(ac)}$.

For slew rates in between the values listed in 8.7.3.2 “Derating Values LPDDR2 tDS/tDH - AC/DC Based AC220” table, the derating values may be obtained by linear interpolation. These values are typically not subject to production test. They are verified by design and characterization.

8.7.3.1 Data Setup and Hold Base-Values

Unit [pS]	LPDDR2-800	reference
tDS(base)	50	$V_{IH/L(ac)} = V_{REF(dc)} \pm 220mV$
tDH(base)	140	$V_{IH/L(dc)} = V_{REF(dc)} \pm 130mV$

Note: ac/dc referenced for 1V/nS DQ,DM slew rate and 2V/nS differential DQS_t-DQS_c slew rate.



8.7.3.2 Derating Values LPDDR2 tDS/tDH - AC/DC Based AC220

Δt_{DS} , Δt_{DH} derating in [pS] AC/DC based a AC220 Threshold -> $V_{IH(ac)} = V_{REF(dc)} + 220mV$, $V_{IL(ac)} = V_{REF(dc)} - 220mV$ DC130 Threshold -> $V_{IH(dc)} = V_{REF(dc)} + 130mV$, $V_{IL(dc)} = V_{REF(dc)} - 130mV$																
DQ, DM Slew Rate V/nS	DQS_t, DQS_c Differential Slew Rate															
	4.0 V/nS		3.0 V/nS		2.0 V/nS		1.8 V/nS		1.6 V/nS		1.4 V/nS		1.2 V/nS		1.0 V/nS	
	Δt_{DS}	Δt_{DH}	Δt_{DS}	Δt_{DH}	Δt_{DS}	Δt_{DH}	Δt_{DS}	Δt_{DH}	Δt_{DS}	Δt_{DH}	Δt_{DS}	Δt_{DH}	Δt_{DS}	Δt_{DH}	Δt_{DS}	Δt_{DH}
2.0	110	65	110	65	110	65	-	-	-	-	-	-	-	-	-	-
1.5	74	43	73	43	73	43	89	59	-	-	-	-	-	-	-	-
1.0	0	0	0	0	0	0	16	16	32	32	-	-	-	-	-	-
0.9	-	-	-3	-5	-3	-5	13	11	29	27	45	43	-	-	-	-
0.8	-	-	-	-	-8	-13	8	3	24	19	40	35	56	55	-	-
0.7	-	-	-	-	-	-	2	-6	18	10	34	26	50	46	66	78
0.6	-	-	-	-	-	-	-	-	10	-3	26	13	42	33	58	65
0.5	-	-	-	-	-	-	-	-	-	-	4	-4	20	16	36	48
0.4	-	-	-	-	-	-	-	-	-	-	-	-	-7	2	17	34

Note: Cell contents '-' are defined as not supported.

8.7.3.3 Required Time tVAC above VIH(ac) {below VIL(ac)} for Valid Transition

Slew Rate [V/nS]	tVAC @ 220mV [pS]	
	min	max
> 2.0	175	-
2.0	170	-
1.5	167	-
1.0	163	-
0.9	162	-
0.8	161	-
0.7	159	-
0.6	155	-
0.5	150	-
<0.5	150	-



8.7.3.4 Nominal Slew Rate and tVAC for Setup Time tDS for DQ with Respect to Strobe

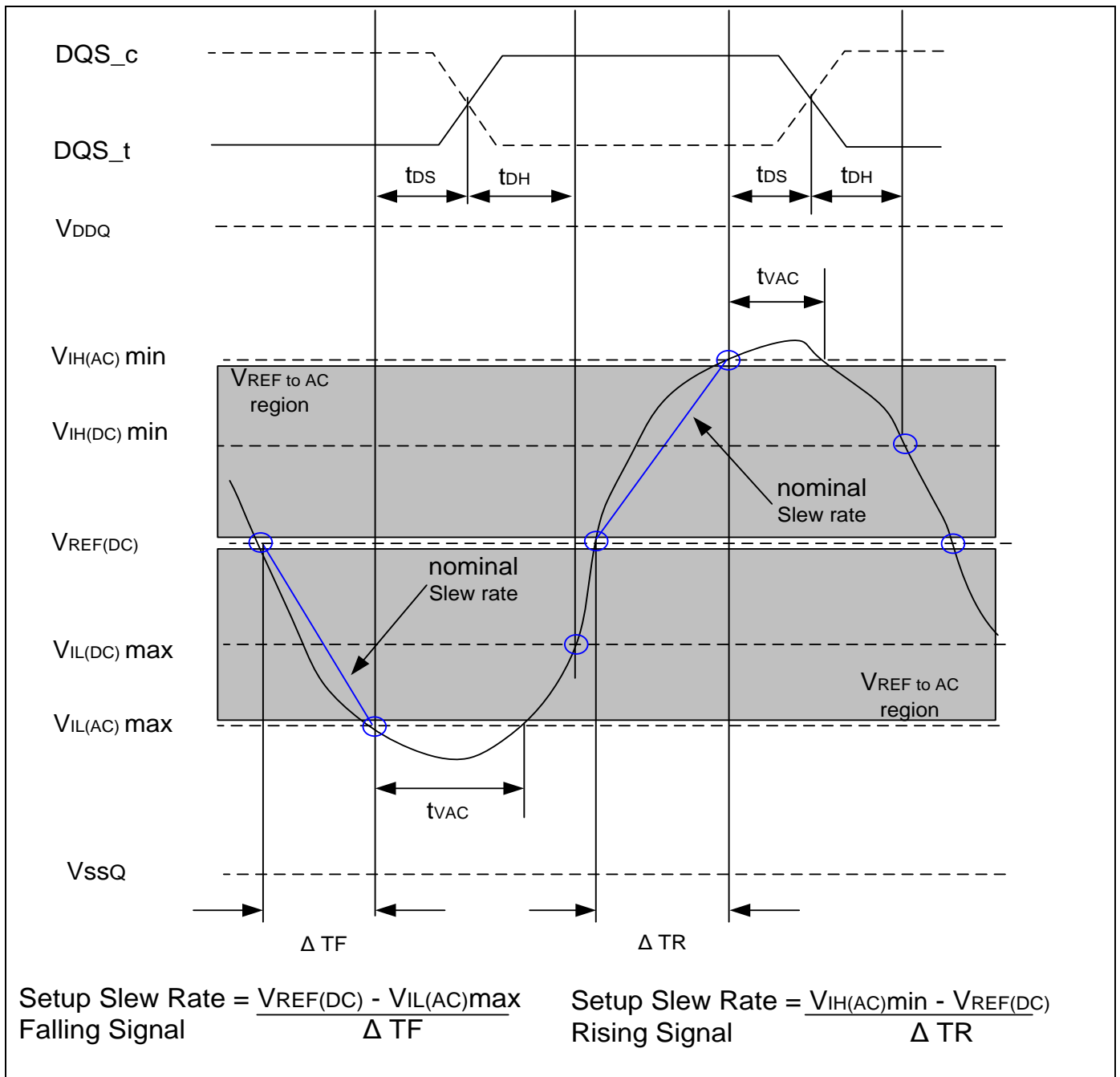



8.7.3.5 Nominal Slew Rate for Hold time t_{DH} for DQ with Respect to Strobe

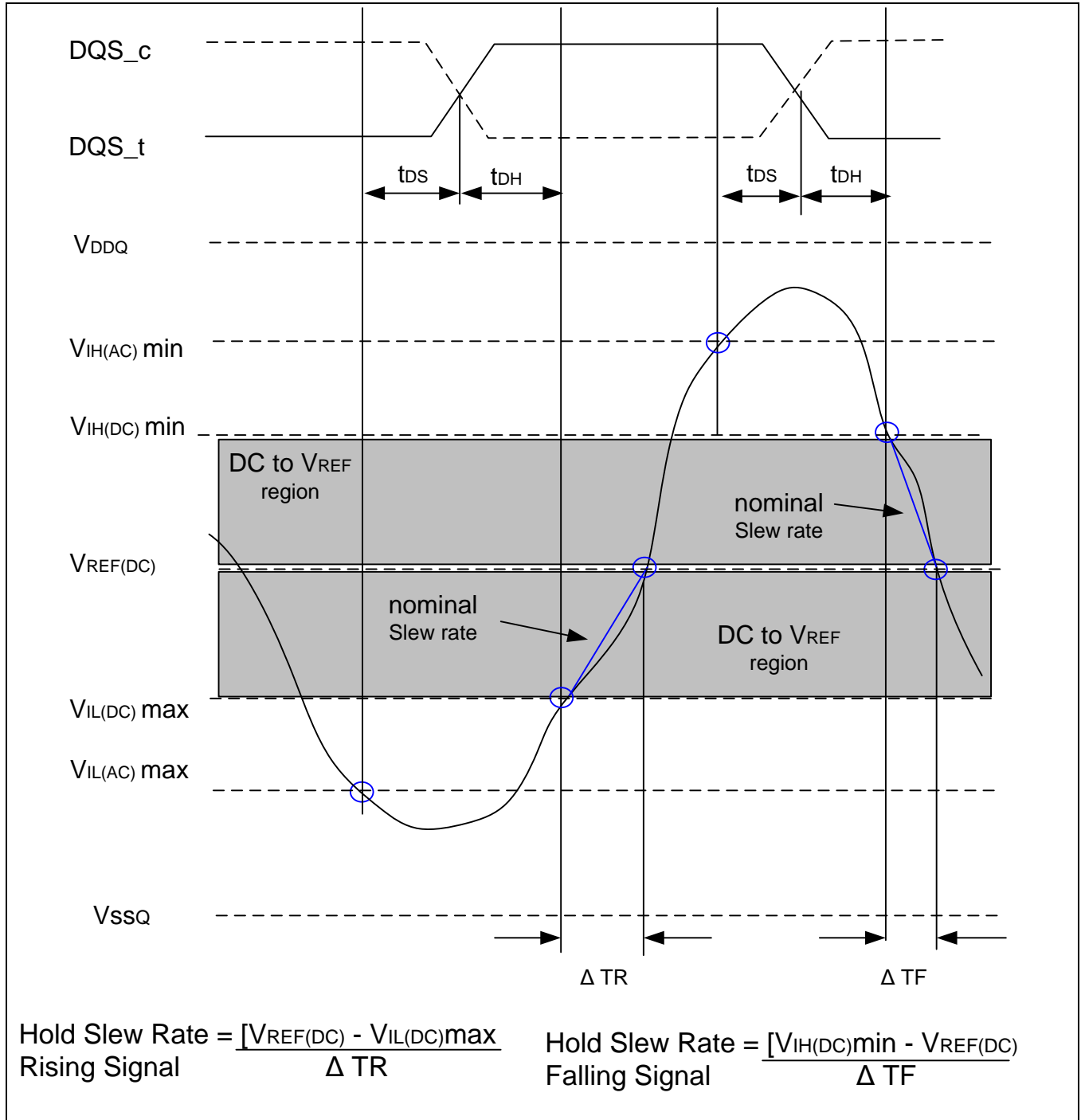



8.7.3.6 Tangent Line for Setup Time tDS for DQ with Respect to Strobe

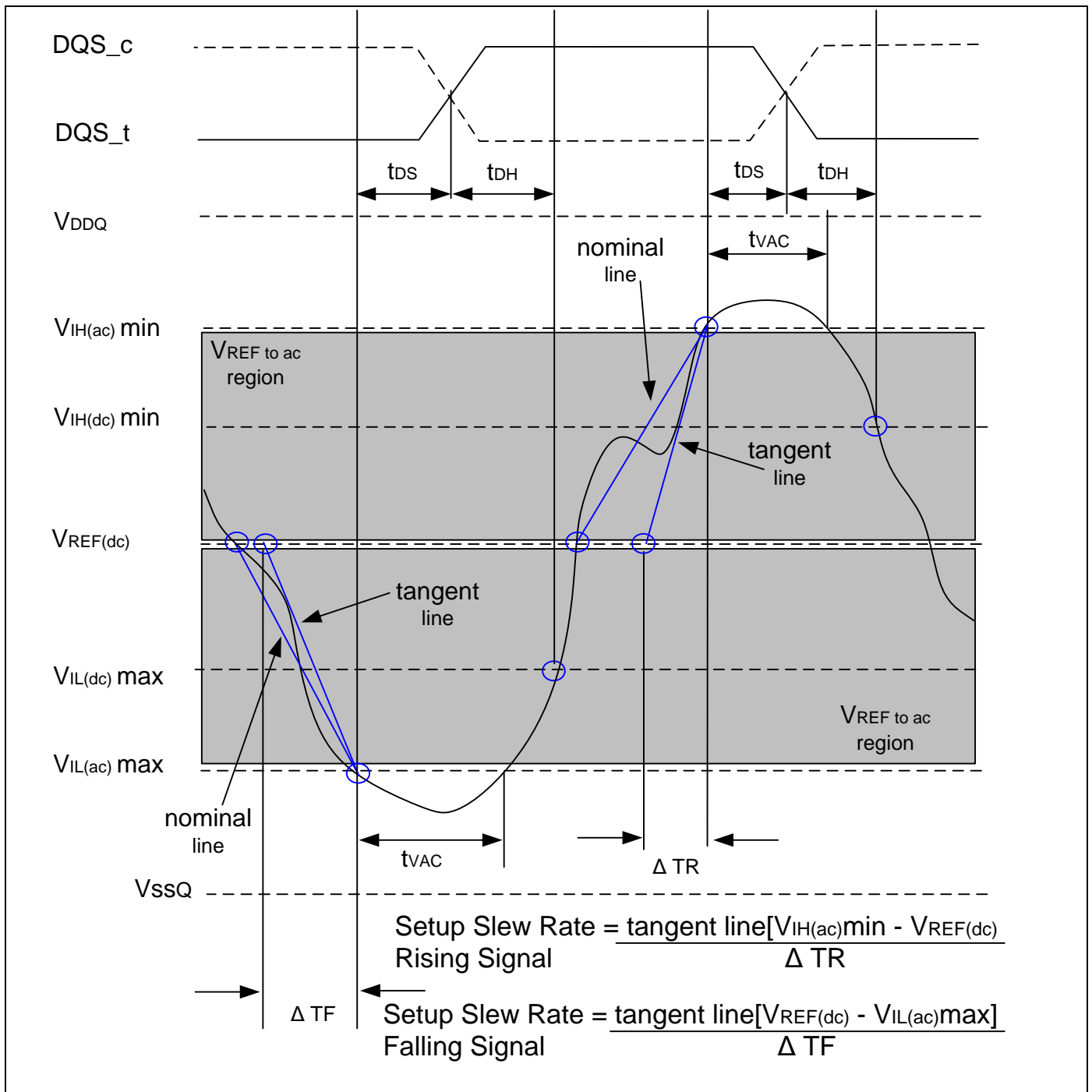



8.7.3.7 Tangent Line for Hold Time t_{DH} for DQ with Respect to Strobe

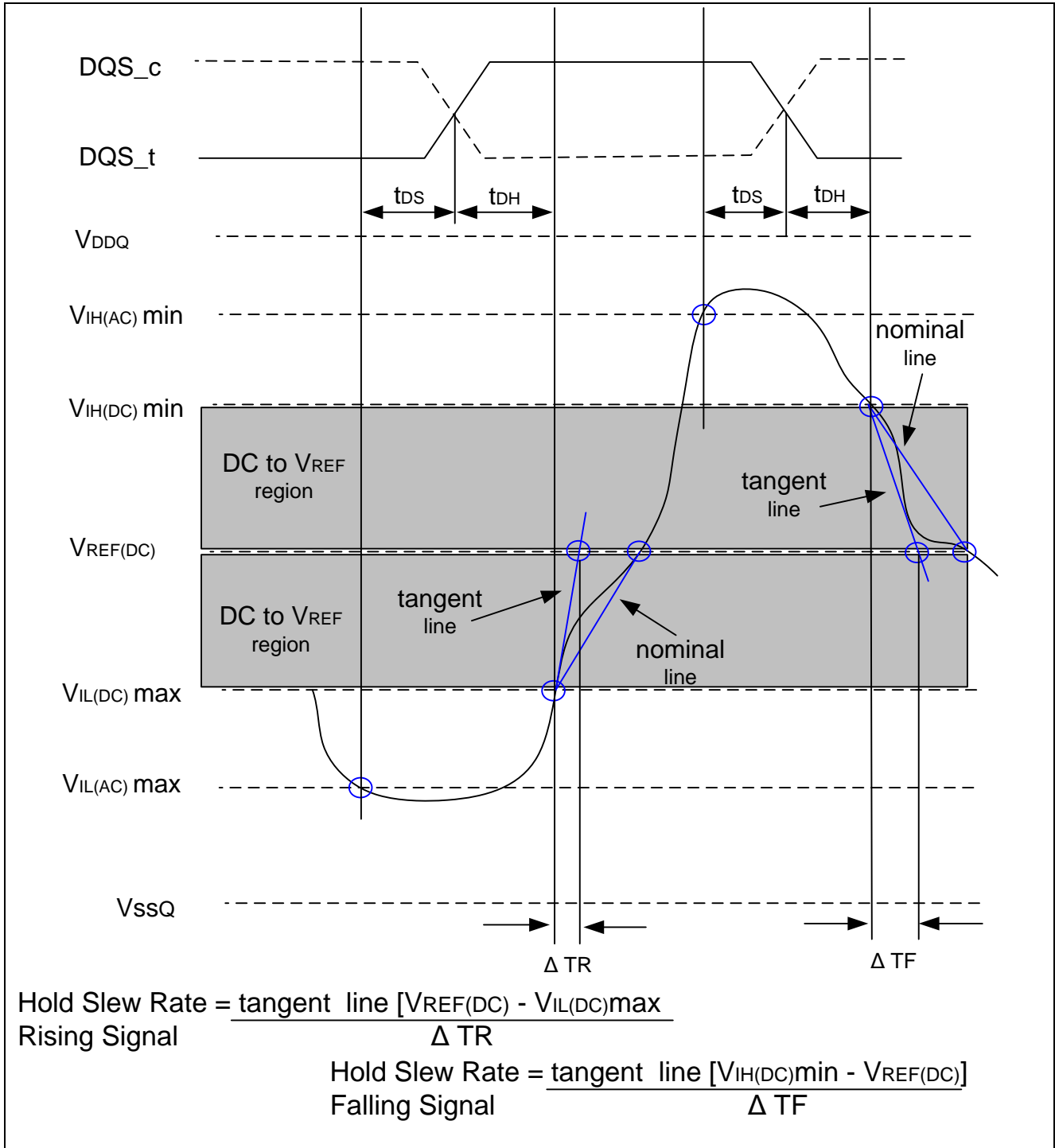



9. PACKAGE DIMENSIONS

Package Outline VFBGA 134 Ball (10x11.5 mm², Ball pitch: 0.65mm, Ø=0.40mm)

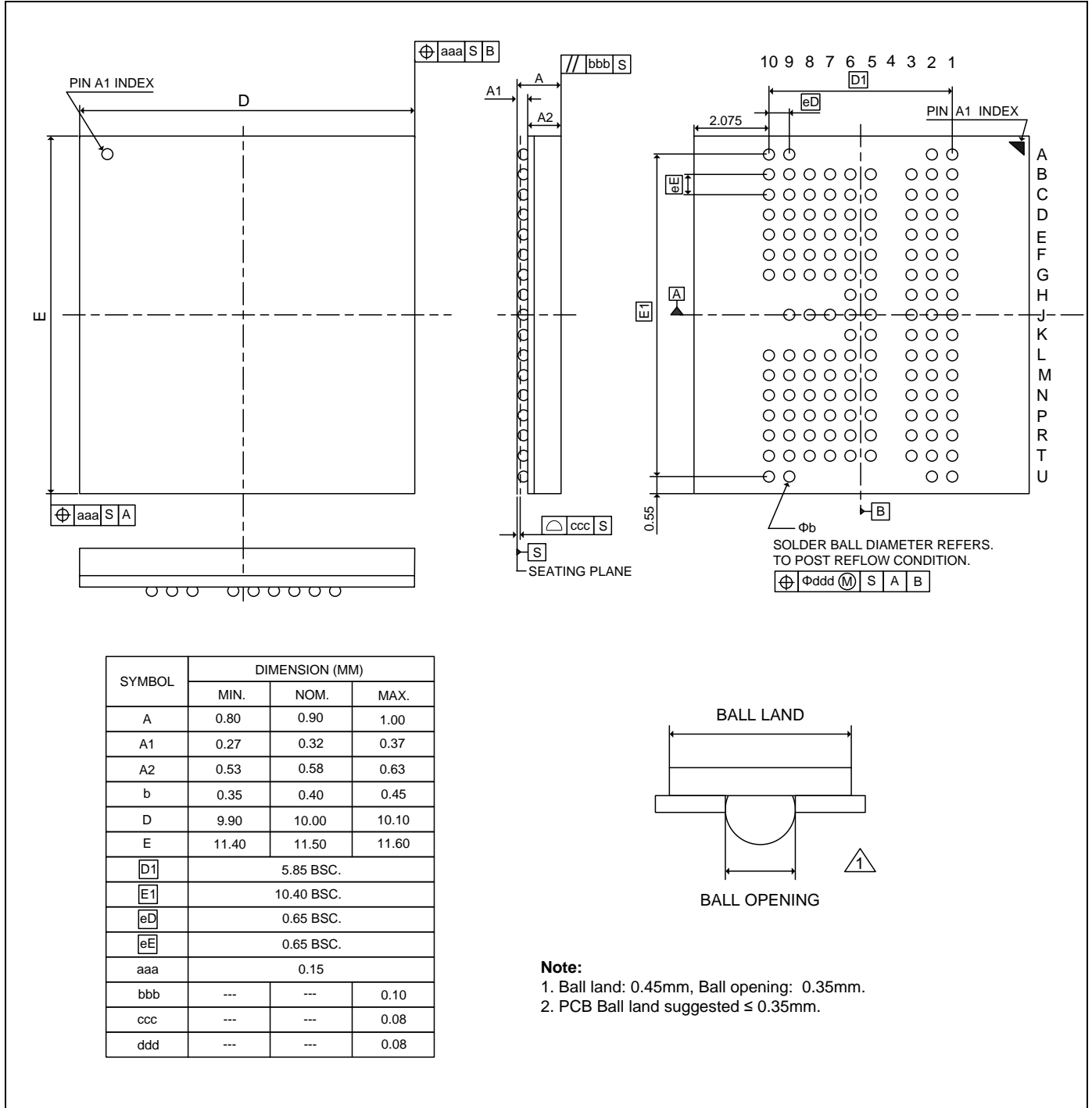



10. REVISION HISTORY

VERSION	DATE	PAGE	DESCRIPTION
A01-001	Sep. 09, 2016	All	Initial formally datasheet
A01-002	Oct. 11, 2016	110	Revise tRCD, tRPpb (single bank) and tRPab 8-bank (all banks) AC parameters from fast spec value to typical spec value Revise data rate 533 to 800 Mb/s/pin tWTR spec from 75 to 7.5ns
A01-003	Feb. 14, 2017	100~102	Update IDDX current value
A01-004	Jul. 04, 2017	6, 9, 126	Removed 168 ball WFBGA parts, ball configuration and package outline drawing

*Please note that all data and specifications are subject to change without notice.
All the trademarks of products and companies mentioned in this datasheet belong to their respective owners.*

*Publication Release Date: Jul. 04, 2017
Revision: A01-004*

Данный компонент на территории Российской Федерации

Вы можете приобрести в компании MosChip.

Для оперативного оформления запроса Вам необходимо перейти по данной ссылке:

<http://moschip.ru/get-element>

Вы можете разместить у нас заказ для любого Вашего проекта, будь то серийное производство или разработка единичного прибора.

В нашем ассортименте представлены ведущие мировые производители активных и пассивных электронных компонентов.

Нашей специализацией является поставка электронной компонентной базы двойного назначения, продукции таких производителей как XILINX, Intel (ex.ALTERA), Vicor, Microchip, Texas Instruments, Analog Devices, Mini-Circuits, Amphenol, Glenair.

Сотрудничество с глобальными дистрибьюторами электронных компонентов, предоставляет возможность заказывать и получать с международных складов практически любой перечень компонентов в оптимальные для Вас сроки.

На всех этапах разработки и производства наши партнеры могут получить квалифицированную поддержку опытных инженеров.

Система менеджмента качества компании отвечает требованиям в соответствии с ГОСТ Р ИСО 9001, ГОСТ РВ 0015-002 и ЭС РД 009

Офис по работе с юридическими лицами:

105318, г.Москва, ул.Щербаковская д.3, офис 1107, 1118, ДЦ «Щербаковский»

Телефон: +7 495 668-12-70 (многоканальный)

Факс: +7 495 668-12-70 (доб.304)

E-mail: info@moschip.ru

Skype отдела продаж:

moschip.ru

moschip.ru_4

moschip.ru_6

moschip.ru_9