

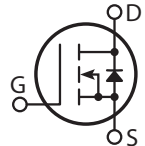

## Super Junction MOSFET

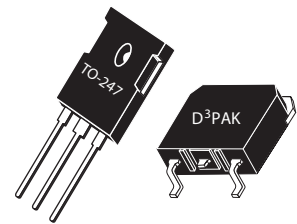

- Ultra low  $R_{DS(ON)}$
- Increased Power Dissipation
- Low Miller Capacitance
- Ultra Low Gate Charge,  $Q_g$
- Avalanche Energy Rated
- TO-247 or Surface Mount D<sup>3</sup>PAK Package

### MAXIMUM RATINGS

All Ratings:  $T_C = 25^\circ\text{C}$  unless otherwise specified.

Symbol	Parameter	APT47N65B_SC3	UNIT
$V_{DSS}$	Drain-Source Voltage	650	Volts
$I_D$	Continuous Drain Current @ $T_C = 25^\circ\text{C}$	47	Amps
$I_{DM}$	Pulsed Drain Current <sup>1</sup>	141	
$V_{GS}$	Gate-Source Voltage Continuous	±20	Volts
$V_{GSM}$	Gate-Source Voltage Transient	±30	
$P_D$	Total Power Dissipation @ $T_C = 25^\circ\text{C}$	417	Watts
	Linear Derating Factor	3.33	W/°C
$T_J, T_{STG}$	Operating and Storage Junction Temperature Range	-55 to 150	°C
$T_L$	Lead Temperature: 0.063" from Case for 10 Sec.	260	
$dv/dt$	Drain-Source Voltage slope ( $V_{DS} = 480\text{V}$ , $I_D = 47\text{A}$ , $T_J = 125^\circ\text{C}$ )	50	V/ns
$I_{AR}$	Repetitive Avalanche Current <sup>7</sup> +++++Repetitive Avalanche Energy <sup>7</sup>	20	Amps
$E_{AR}$	Single Pulse Avalanche Energy <sup>4</sup>	1	mJ
$E_{AS}$	Single Pulse Avalanche Energy <sup>4</sup>	1800	

### STATIC ELECTRICAL CHARACTERISTICS

Symbol	Characteristic / Test Conditions	MIN	TYP	MAX	UNIT
$BV_{DSS}$	Drain-Source Breakdown Voltage ( $V_{GS} = 0\text{V}$ , $I_D = 250\mu\text{A}$ )	650			Volts
$R_{DS(on)}$	Drain-Source On-State Resistance <sup>2</sup> ( $V_{GS} = 10\text{V}$ , $I_D = 30\text{A}$ )		0.06	0.07	Ohms
$I_{DSS}$	Zero Gate Voltage Drain Current ( $V_{DS} = 650\text{V}$ , $V_{GS} = 0\text{V}$ )		0.5	25	μA
	Zero Gate Voltage Drain Current ( $V_{DS} = 650\text{V}$ , $V_{GS} = 0\text{V}$ , $T_J = 150^\circ\text{C}$ )			250	
$I_{GSS}$	Gate-Source Leakage Current ( $V_{GS} = \pm 20\text{V}$ , $V_{DS} = 0\text{V}$ )			±100	nA
$V_{GS(th)}$	Gate Threshold Voltage ( $V_{DS} = V_{GS}$ , $I_D = 2.7\text{mA}$ )	2.10	3	3.9	Volts

 CAUTION: These Devices are Sensitive to Electrostatic Discharge. Proper Handling Procedures Should Be Followed.

"COOLMOS™" comprise a new family of transistors developed by Infineon Technologies AG. "COOLMOS" is a trademark of Infineon Technologies AG."

Microsemi Website - <http://www.microsemi.com>

# DYNAMIC CHARACTERISTICS

APT47N65BC3

Symbol	Characteristic	Test Conditions	MIN	TYP	MAX	UNIT
C <sub>iss</sub>	Input Capacitance	V <sub>GS</sub> = 0V V <sub>DS</sub> = 25V f = 1 MHz		6965	8355	pF
C <sub>oss</sub>	Output Capacitance			2100	2940	
C <sub>rss</sub>	Reverse Transfer Capacitance			85	127	
Q <sub>g</sub>	Total Gate Charge <sup>3</sup>	V <sub>GS</sub> = 10V V <sub>DD</sub> = 300V I <sub>D</sub> = 47A @ 25°C		250	375	nC
Q <sub>gs</sub>	Gate-Source Charge			30	45	
Q <sub>gd</sub>	Gate-Drain ("Miller") Charge			105	157	
t <sub>d(on)</sub>	Turn-on Delay Time	<b>INDUCTIVE SWITCHING</b> V <sub>GS</sub> = 13V V <sub>DD</sub> = 380V I <sub>D</sub> = 47A @ 125°C R <sub>G</sub> = 5Ω		18	36	ns
t <sub>r</sub>	Rise Time			28	56	
t <sub>d(off)</sub>	Turn-off Delay Time			295	442	
t <sub>f</sub>	Fall Time			84	168	
E <sub>on</sub>	Turn-on Switching Energy <sup>6</sup>	<b>INDUCTIVE SWITCHING @ 25°C</b> V <sub>DD</sub> = 400V, V <sub>GS</sub> = 15V I <sub>D</sub> = 47A, R <sub>G</sub> = 5Ω		810	1620	μJ
E <sub>off</sub>	Turn-off Switching Energy			840	1680	
E <sub>on</sub>	Turn-on Switching Energy <sup>6</sup>	<b>INDUCTIVE SWITCHING @ 125°C</b> V <sub>DD</sub> = 400V, V <sub>GS</sub> = 15V I <sub>D</sub> = 47A, R <sub>G</sub> = 5Ω		1172	1758	
E <sub>off</sub>	Turn-off Switching Energy			985	1970	

# SOURCE-DRAIN DIODE RATINGS AND CHARACTERISTICS

Symbol	Characteristic / Test Conditions	MIN	TYP	MAX	UNIT
I <sub>S</sub>	Continuous Source Current (Body Diode)			47	Amps
I <sub>SM</sub>	Pulsed Source Current <sup>1</sup> (Body Diode)			141	
V <sub>SD</sub>	Diode Forward Voltage <sup>2</sup> (V <sub>GS</sub> = 0V, I <sub>S</sub> = -47A)			1.2	Volts
t <sub>rr</sub>	Reverse Recovery Time (I <sub>S</sub> = -47A, di <sub>S</sub> /dt = 100A/μs, V <sub>R</sub> = 350V)		580	650	ns
Q <sub>rr</sub>	Reverse Recovery Charge (I <sub>S</sub> = -47A, di <sub>S</sub> /dt = 100A/μs, V <sub>R</sub> = 350V)		23	16.5	μC
dv <sub>dt</sub>	Peak Diode Recovery dv <sub>dt</sub> <sup>5</sup>			6	V/ns

# THERMAL CHARACTERISTICS

Symbol	Characteristic	MIN	TYP	MAX	UNIT
R <sub>θJC</sub>	Junction to Case			0.30	°C/W
R <sub>θJA</sub>	Junction to Ambient			62	

① Repetitive Rating: Pulse width limited by maximum junction temperature

② Pulse Test: Pulse width < 380 μs, Duty Cycle < 2%

③ See MIL-STD-750 Method 3471

④ Starting T<sub>J</sub> = +25°C, L = 36.0mH, R<sub>G</sub> = 25Ω, Peak I<sub>L</sub> = 10A

⑤ dv<sub>dt</sub> numbers reflect the limitations of the test circuit rather than the device itself. I<sub>S</sub> = -I<sub>D</sub> 47A, di<sub>S</sub>/dt = 700A/μs, V<sub>R</sub> = V<sub>DSS</sub>, T<sub>J</sub> = 150°C

⑥ Eon includes diode reverse recovery. See figures 18, 20.

⑦ Repetitive avalanche causes additional power losses that can be calculated as P<sub>AV</sub> = E<sub>AR</sub> \* f

Microsemi Reserves the right to change, without notice, the specifications and information contained herein.

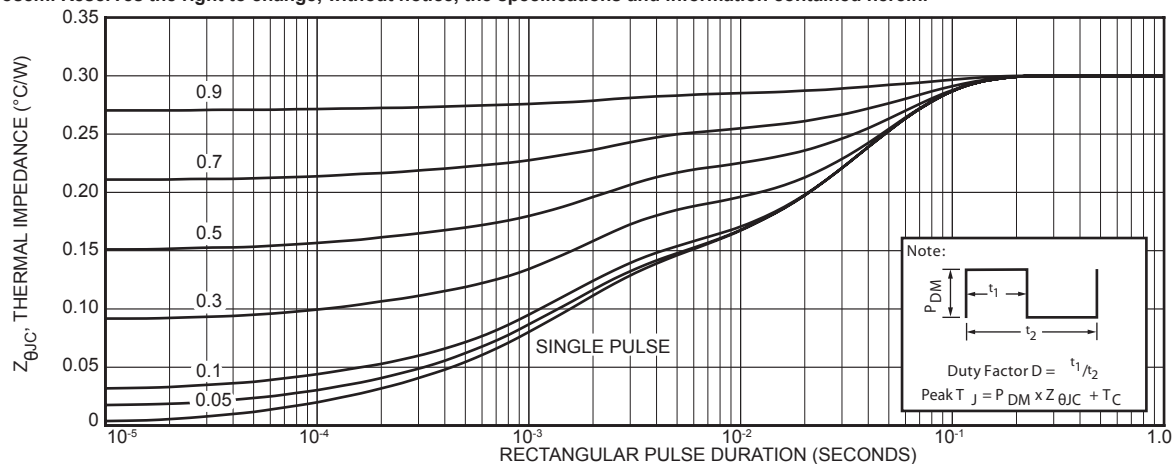

FIGURE 1, MAXIMUM EFFECTIVE TRANSIENT THERMAL IMPEDANCE, JUNCTION-TO-CASE vs PULSE DURATION

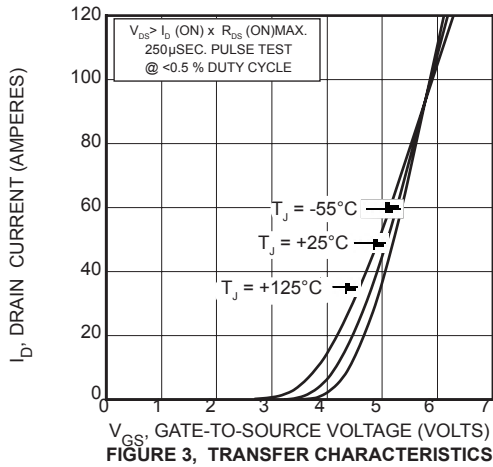

FIGURE 3, TRANSFER CHARACTERISTICS

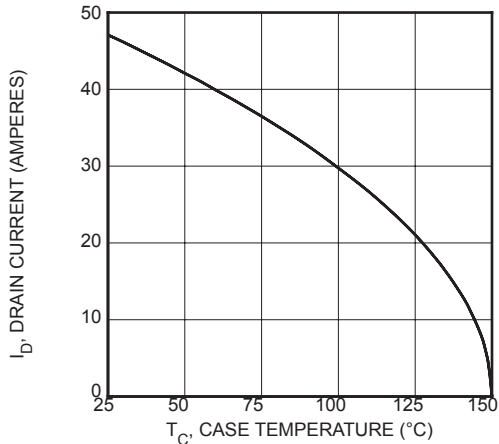

FIGURE 5, MAXIMUM DRAIN CURRENT vs CASE TEMPERATURE

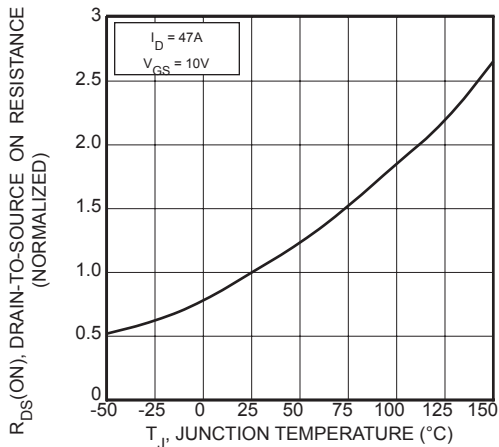

FIGURE 7, ON-RESISTANCE vs. TEMPERATURE

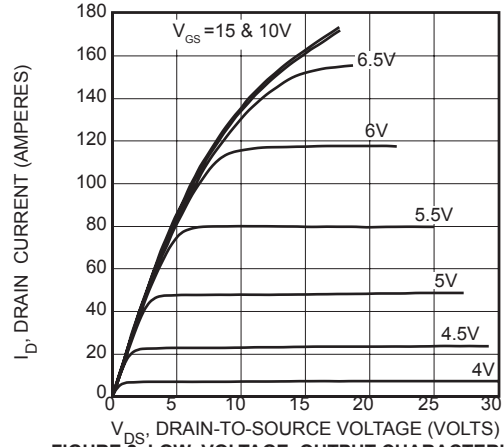

FIGURE 2, LOW VOLTAGE OUTPUT CHARACTERISTICS

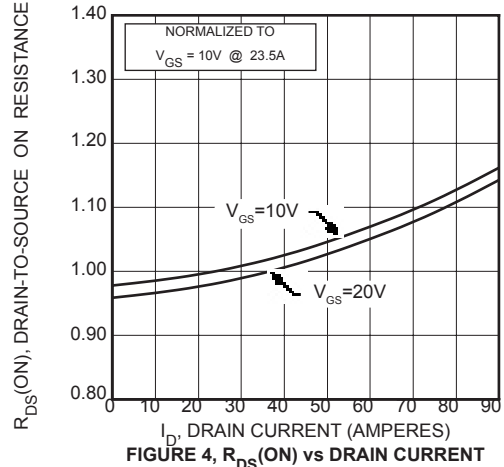

FIGURE 4,  $R_{DS(ON)}$  vs DRAIN CURRENT

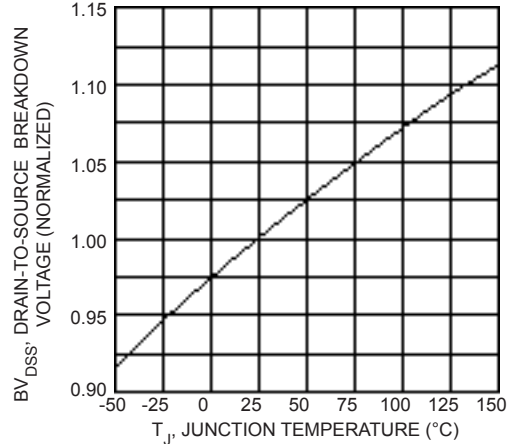

FIGURE 6, BREAKDOWN VOLTAGE vs TEMPERATURE

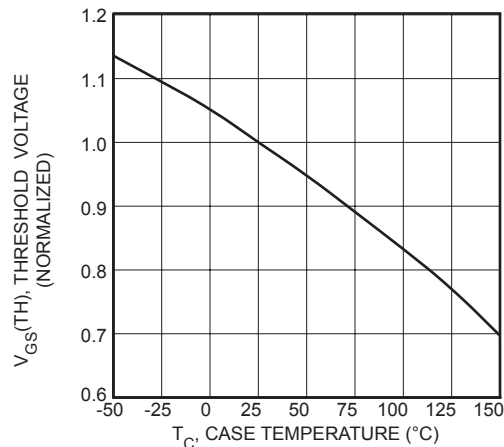

FIGURE 8, THRESHOLD VOLTAGE vs TEMPERATURE

# Typical Performance Curves

APT47N65B\_SC3

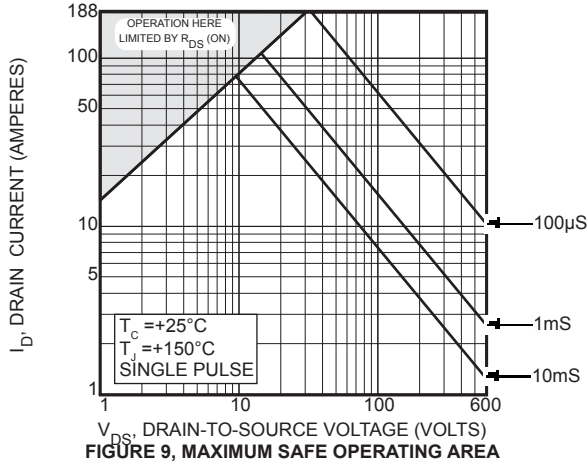

FIGURE 9, MAXIMUM SAFE OPERATING AREA

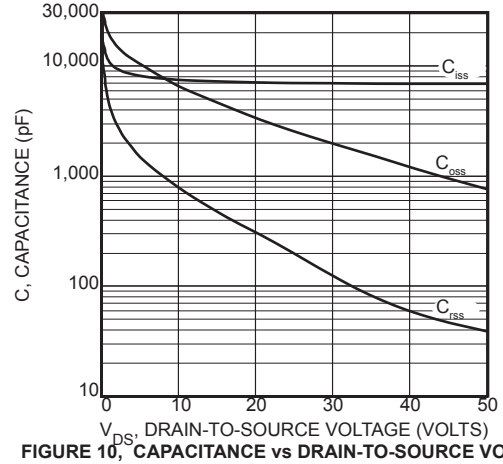

FIGURE 10, CAPACITANCE vs DRAIN-TO-SOURCE VOLTAGE

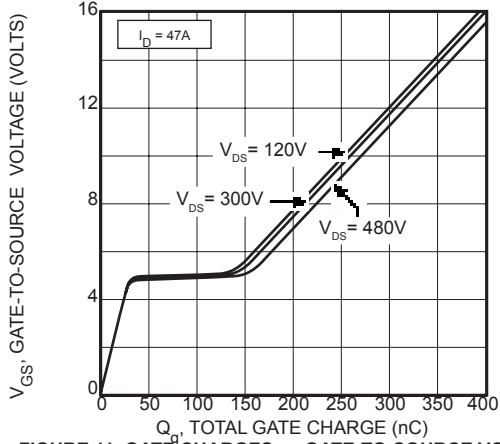

FIGURE 11, GATE CHARGES vs GATE-TO-SOURCE VOLTAGE

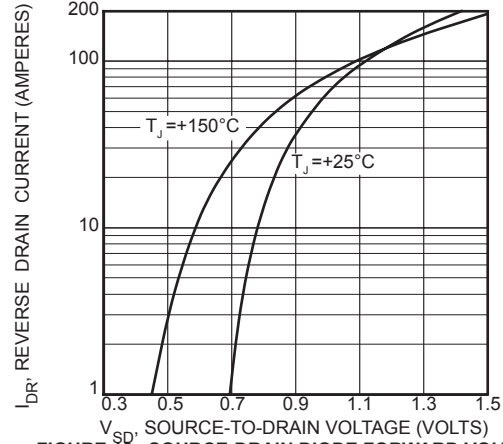

FIGURE 12, SOURCE-DRAIN DIODE FORWARD VOLTAGE

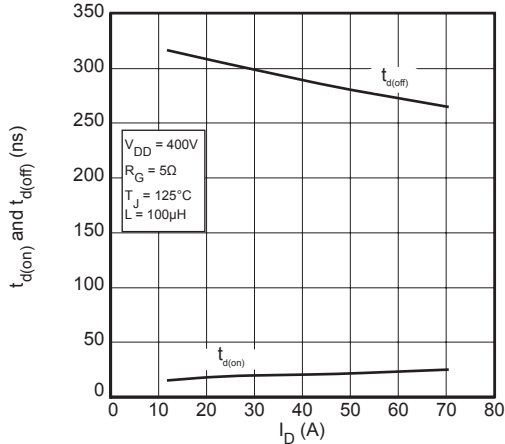

FIGURE 13, DELAY TIMES vs CURRENT

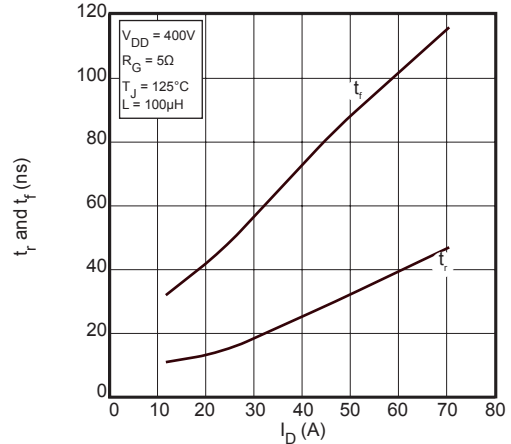

FIGURE 14, RISE AND FALL TIMES vs CURRENT

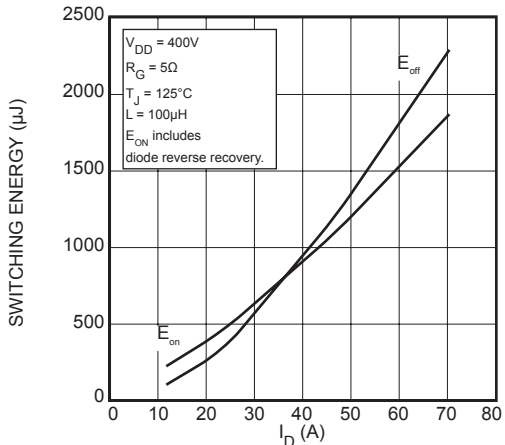

FIGURE 15, SWITCHING ENERGY vs CURRENT

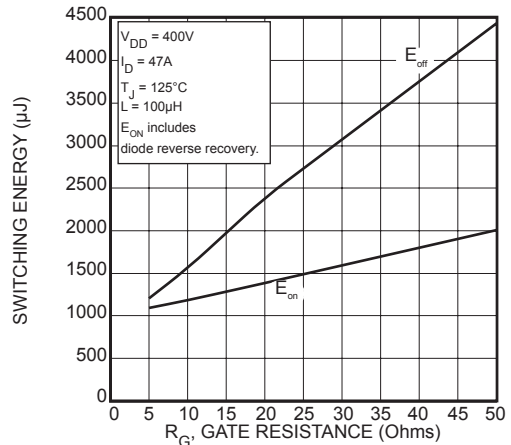

FIGURE 16, SWITCHING ENERGY vs. GATE RESISTANCE

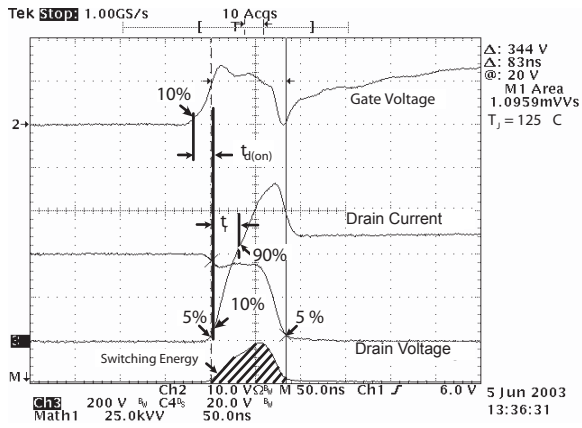

Figure 18, Turn-on Switching Waveforms and Definitions

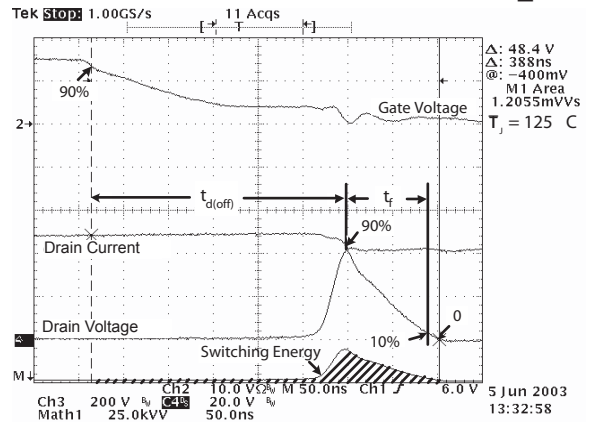

Figure 19, Turn-off Switching Waveforms and Definitions

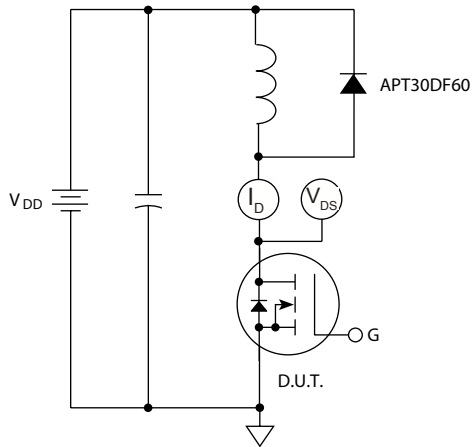
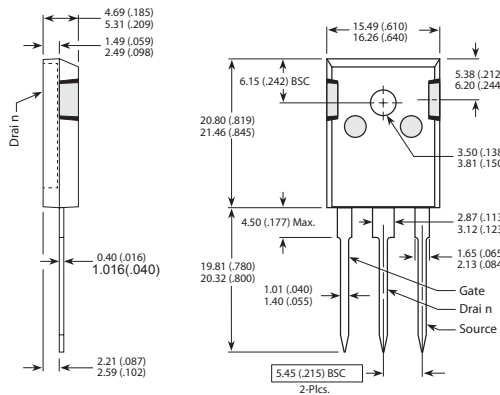

Figure 20, Inductive Switching Test Circuit

TO-247 Package Outline



D<sup>3</sup>PAK (S) Package Outline

100% SN Plated

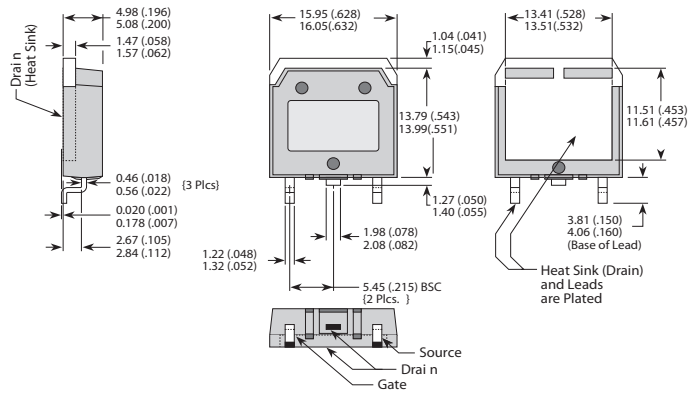

**Disclaimer:**

The information contained in the document (unless it is publicly available on the Web without access restrictions) is PROPRIETARY AND CONFIDENTIAL information of Microsemi and cannot be copied, published, uploaded, posted, transmitted, distributed or disclosed or used without the express duly signed written consent of Microsemi. If the recipient of this document has entered into a disclosure agreement with Microsemi, then the terms of such Agreement will also apply. This document and the information contained herein may not be modified, by any person other than authorized personnel of Microsemi. No license under any patent, copyright, trade secret or other intellectual property right is granted to or conferred upon you by disclosure or delivery of the information, either expressly, by implication, inducement, estoppels or otherwise. Any license under such intellectual property rights must be approved by Microsemi in writing signed by an officer of Microsemi.

Microsemi reserves the right to change the configuration, functionality and performance of its products at anytime without any notice. This product has been subject to limited testing and should not be used in conjunction with life-support or other mission-critical equipment or applications. Microsemi assumes no liability whatsoever, and Microsemi disclaims any express or implied warranty, relating to sale and/or use of Microsemi products including liability or warranties relating to fitness for a particular purpose, merchantability, or infringement of any patent, copyright or other intellectual property right. Any performance specifications believed to be reliable but are not verified and customer or user must conduct and complete all performance and other testing of this product as well as any user or customer's final application. User or customer shall not rely on any data and performance specifications or parameters provided by Microsemi. It is the customer's and user's responsibility to independently determine suitability of any Microsemi product and to test and verify the same. The information contained herein is provided "AS IS, WHERE IS" and with all faults, and the entire risk associated with such information is entirely with the User. Microsemi specifically disclaims any liability of any kind including for consequential, incidental and punitive damages as well as lost profit. The product is subject to other terms and conditions which can be located on the web at <http://www.microsemi.com/terms-a-conditions>.

## Данный компонент на территории Российской Федерации

### Вы можете приобрести в компании MosChip.

Для оперативного оформления запроса Вам необходимо перейти по данной ссылке:

<http://moschip.ru/get-element>

Вы можете разместить у нас заказ для любого Вашего проекта, будь то серийное производство или разработка единичного прибора.

В нашем ассортименте представлены ведущие мировые производители активных и пассивных электронных компонентов.

Нашей специализацией является поставка электронной компонентной базы двойного назначения, продукции таких производителей как XILINX, Intel (ex.ALTERA), Vicor, Microchip, Texas Instruments, Analog Devices, Mini-Circuits, Amphenol, Glenair.

Сотрудничество с глобальными дистрибьюторами электронных компонентов, предоставляет возможность заказывать и получать с международных складов практически любой перечень компонентов в оптимальные для Вас сроки.

На всех этапах разработки и производства наши партнеры могут получить квалифицированную поддержку опытных инженеров.

Система менеджмента качества компании отвечает требованиям в соответствии с ГОСТ Р ИСО 9001, ГОСТ РВ 0015-002 и ЭС РД 009

### Офис по работе с юридическими лицами:

105318, г.Москва, ул.Щербаковская д.3, офис 1107, 1118, ДЦ «Щербаковский»

Телефон: +7 495 668-12-70 (многоканальный)

Факс: +7 495 668-12-70 (доб.304)

E-mail: [info@moschip.ru](mailto:info@moschip.ru)

Skype отдела продаж:

moschip.ru

moschip.ru\_4

moschip.ru\_6

moschip.ru\_9