

11mm Snap-In, Insulated and Metal Shaft

Application

- ✓ TV/Video, Audio, Home appliance, Musical instrument

Feature

- ✓ Closed structure helps reducing dust



■ Specification

| | |
|---------------------------------------|---|
| Total Rotational Angle | 300±5° |
| Maximum Operating Voltage | 50V AC, 20V DC (RV110TF series is designed for AC voltage only) |
| Insulation Resistance | 100MΩ at DC500V |
| Dielectric Strength | AC300V for 1 minute |
| Rotational Torque | 20-200 gf.cm (RV110F-40B1: 10-200 gf.cm) |
| Click Torque | Rotational torque + 20-200 gf.cm (RV110F-40B1: Rotational torque + 10-200 gf.cm) |
| Rotational Stop Strength of the Shaft | With bushing: 5 kgf.cm min; without bushing: 4kgf.cm min |
| Push/Pull Strength of the Shaft | 6kgf for 3 sec |
| Rotation Life | 15,000 cycles |

■ How to order

RV110F-20 – 15A - B10K - 0C

Model

Shaft Type

Taper and Resistance Value

| Order Code | Taper | Resistance Value |
|------------|-----------|------------------|
| A100K | Log/A | 100KΩ |
| B1M | Linear/B | 1MΩ |
| C500K | Rev-log/C | 500KΩ |

Taper: A, B and C

Resistance Value: 1KΩ to 500KΩ and 1MΩ

*Contact us for other requirements.

** RV112F series only has W taper

Click

| Order Code | Description |
|------------|-------------------|
| Blank | No click |
| 0C | With center click |

11mm Snap-In, Insulated and Metal Shaft

Model Description



| Model | Number of Unit | Terminal Type | With Sleeve or Bushing | Tap |
|------------------------------|----------------|---------------|------------------------|----------|
| RV110F-20 | Single unit | Horizontal | N/A | N/A |
| RV110F-21 | Single unit | Horizontal | N/A | N/A |
| RV110F-20E1 | Single unit | Horizontal | Bushing | N/A |
| RV110F-21E1 | Single unit | Horizontal | Bushing | N/A |
| RV110F-40 | Single unit | Vertical | N/A | N/A |
| RV110CF-40 | Single unit | Vertical | Sleeve | N/A |
| RV110F-40B1 | Single unit | Vertical | Bushing | N/A |
| RV110F-40E1 | Single unit | Vertical | Bushing | N/A |
| RV110TF-20 | Single unit | Horizontal | N/A | With tap |
| RV110TF-20E1 | Single unit | Horizontal | Bushing | With tap |
| RV110TF-40 | Single unit | Vertical | N/A | With tap |
| RV110TCF-40 | Single unit | Vertical | Sleeve | With tap |
| RV110TF-40B1 | Single unit | Vertical | Bushing | With tap |
| RV110TF-40E1 | Single unit | Vertical | Bushing | With tap |
| RV112F-40 | Dual unit | Vertical | N/A | N/A |

[Back to top](#)

11mm Snap-In, Insulated and Metal Shaft

| Order Code | Outline Drawing | | | | | | | | | | | |
|--|---|--|--|------|---|---|----|------|-----|----|------|-----|
| RV110F-20 RV110F-21  |  | SHAFT SHOWN IN FULL C.C.W POSITION  | <table border="1" data-bbox="1292 324 1428 414"> <thead> <tr> <th>Type</th> <th>H</th> <th>N</th> </tr> </thead> <tbody> <tr> <td>20</td> <td>10.0</td> <td>3.2</td> </tr> <tr> <td>21</td> <td>12.5</td> <td>4.5</td> </tr> </tbody> </table>  <p>P.C.B. MOUNTING HOLE DETAIL</p> | Type | H | N | 20 | 10.0 | 3.2 | 21 | 12.5 | 4.5 |
| Type | H | N | | | | | | | | | | |
| 20 | 10.0 | 3.2 | | | | | | | | | | |
| 21 | 12.5 | 4.5 | | | | | | | | | | |
| RV110F-20E1 RV110F-21E1  |  | SHAFT SHOWN IN FULL C.C.W POSITION  | <table border="1" data-bbox="1292 772 1428 862"> <thead> <tr> <th>Type</th> <th>H</th> <th>N</th> </tr> </thead> <tbody> <tr> <td>20</td> <td>10.0</td> <td>3.2</td> </tr> <tr> <td>21</td> <td>12.5</td> <td>4.5</td> </tr> </tbody> </table>  <p>P.C.B. MOUNTING HOLE DETAIL</p> | Type | H | N | 20 | 10.0 | 3.2 | 21 | 12.5 | 4.5 |
| Type | H | N | | | | | | | | | | |
| 20 | 10.0 | 3.2 | | | | | | | | | | |
| 21 | 12.5 | 4.5 | | | | | | | | | | |
| RV110F-40  |  | SHAFT SHOWN IN FULL C.C.W POSITION  |  <p>P.C.B. MOUNTING HOLE DETAIL</p> | | | | | | | | | |
| RV110CF-40  |  | SHAFT SHOWN IN FULL C.C.W POSITION  |  <p>P.C.B. MOUNTING HOLE DETAIL</p> | | | | | | | | | |







[Back to top](#)

11mm Snap-In, Insulated and Metal Shaft

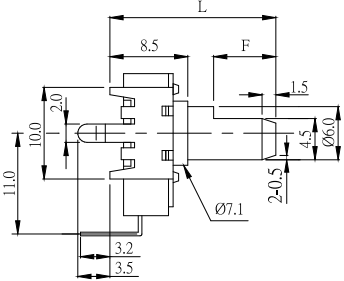
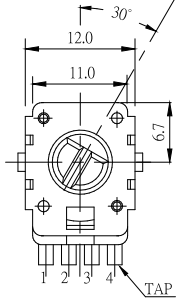
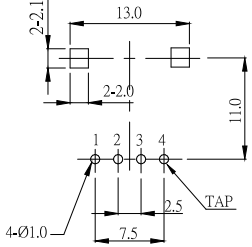
| Order Code | Outline Drawing | | | | | | | | | | | |
|---|---|---|---|------|---|---|----|------|-----|----|------|-----|
| RV110F-40B1  |  | <p>SHAFT SHOWN IN FULL C.C.W POSITION</p>  |  <p>P.C.B. MOUNTING HOLE DETAIL</p> | | | | | | | | | |
| RV110F-40E1  |  | <p>SHAFT SHOWN IN FULL C.C.W POSITION</p>  |  <p>P.C.B. MOUNTING HOLE DETAIL</p> | | | | | | | | | |
| RV110TF-20 RV110TF-21  |  | <p>SHAFT SHOWN IN FULL C.C.W POSITION</p>  | <table border="1" data-bbox="1316 1198 1444 1288"> <thead> <tr> <th>Type</th> <th>H</th> <th>N</th> </tr> </thead> <tbody> <tr> <td>20</td> <td>10.0</td> <td>3.2</td> </tr> <tr> <td>21</td> <td>12.5</td> <td>4.5</td> </tr> </tbody> </table>  <p>P.C.B. MOUNTING HOLE DETAIL</p> | Type | H | N | 20 | 10.0 | 3.2 | 21 | 12.5 | 4.5 |
| Type | H | N | | | | | | | | | | |
| 20 | 10.0 | 3.2 | | | | | | | | | | |
| 21 | 12.5 | 4.5 | | | | | | | | | | |
| RV110TF-20E1 RV110TF-21E1  |  | <p>SHAFT SHOWN IN FULL C.C.W POSITION</p>  | <table border="1" data-bbox="1316 1646 1444 1736"> <thead> <tr> <th>Type</th> <th>H</th> <th>N</th> </tr> </thead> <tbody> <tr> <td>20</td> <td>10.0</td> <td>3.2</td> </tr> <tr> <td>21</td> <td>12.5</td> <td>4.5</td> </tr> </tbody> </table>  <p>P.C.B. MOUNTING HOLE DETAIL</p> | Type | H | N | 20 | 10.0 | 3.2 | 21 | 12.5 | 4.5 |
| Type | H | N | | | | | | | | | | |
| 20 | 10.0 | 3.2 | | | | | | | | | | |
| 21 | 12.5 | 4.5 | | | | | | | | | | |

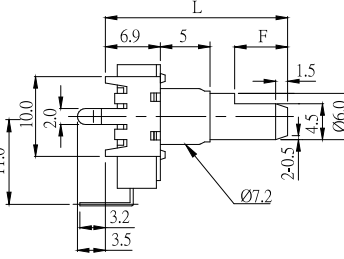
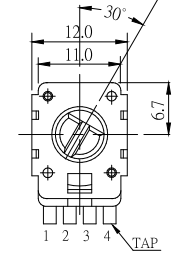
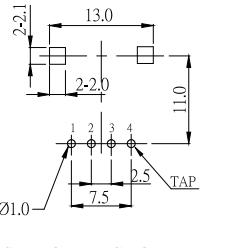
[Back to top](#)

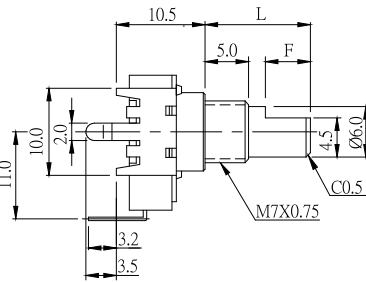
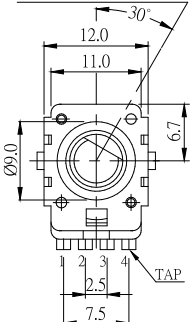
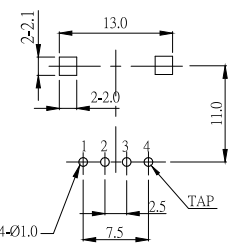
11mm Snap-In, Insulated and Metal Shaft

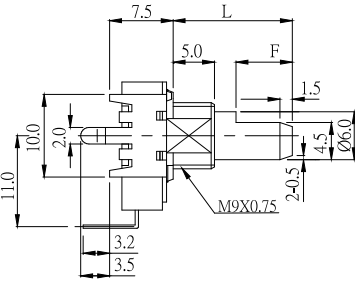
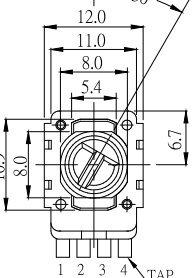
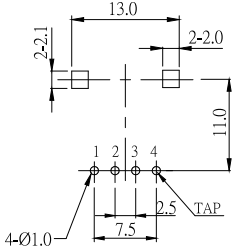
| Order Code | Outline Drawing | | |
|---|---|--|--|
| <p>RV110TF-40</p>  |  | <p>SHAFT SHOWN IN FULL C.C.W POSITION</p>  |  <p>P.C.B. MOUNTING HOLE DETAIL</p> |
| <p>RV110TCF-40</p>  |  | <p>SHAFT SHOWN IN FULL C.C.W POSITION</p>  |  <p>P.C.B. MOUNTING HOLE DETAIL</p> |
| <p>RV110TF-40B1</p>  |  | <p>SHAFT SHOWN IN FULL C.C.W POSITION</p>  |  <p>P.C.B. MOUNTING HOLE DETAIL</p> |
| <p>RV110TF-40E1</p>  |  | <p>SHAFT SHOWN IN FULL C.C.W POSITION</p>  |  <p>P.C.B. MOUNTING HOLE DETAIL</p> |

[Back to top](#)

11mm Snap-In, Insulated and Metal Shaft

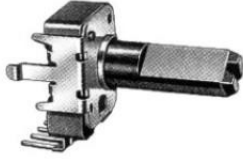
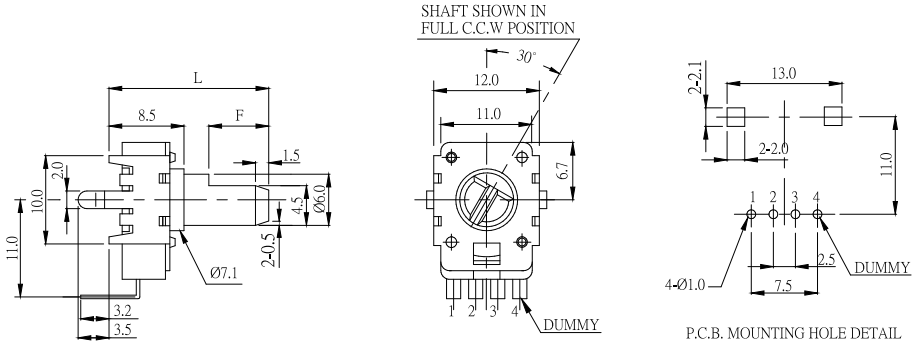
| Order Code | Outline Drawing |
|--|---|
| RV112F-40  |  <p>SHAFT SHOWN IN FULL C.C.W POSITION</p> <p>P.C.B. MOUNTING HOLE DETAIL</p> |

■ Metal Shaft Type

| F Type | K Type | | | | | | | | | | | | | | | | |
|---|--|-----|-----|-----|---|----|----|----|--|------------|-----|-----|-----|---|----|----|----|
| RV110F-40B1-(L)F RV110TF-40B1-(L)F | RV110F-40B1-(L)K RV110TF-40B1-(L)K | | | | | | | | | | | | | | | | |
|  |  | | | | | | | | | | | | | | | | |
| <table border="1" data-bbox="172 1599 692 1697"> <thead> <tr> <th>Order Code</th> <th>15F</th> <th>20F</th> <th>25F</th> </tr> </thead> <tbody> <tr> <td>L</td> <td>15</td> <td>20</td> <td>25</td> </tr> </tbody> </table> | Order Code | 15F | 20F | 25F | L | 15 | 20 | 25 | <table border="1" data-bbox="898 1599 1418 1697"> <thead> <tr> <th>Order Code</th> <th>15K</th> <th>20K</th> <th>25K</th> </tr> </thead> <tbody> <tr> <td>L</td> <td>15</td> <td>20</td> <td>25</td> </tr> </tbody> </table> | Order Code | 15K | 20K | 25K | L | 15 | 20 | 25 |
| Order Code | 15F | 20F | 25F | | | | | | | | | | | | | | |
| L | 15 | 20 | 25 | | | | | | | | | | | | | | |
| Order Code | 15K | 20K | 25K | | | | | | | | | | | | | | |
| L | 15 | 20 | 25 | | | | | | | | | | | | | | |

[Back to top](#)

11mm Snap-In, Insulated and Metal Shaft

■ A / AW Plastic Shaft Type

| | | |
|--|---|---|
| RV110F-20 (21)-(L)A RV110TF-20 (21)-(L)A | RV110F-40-(L)A RV110TF-40-(L)A RV112F-40-(L)A | RV110CF-40-(L)A RV110TCF-40-(L)A |
|  |  |  |

| Order Code | *15A | 20A | 225A | 25A | 275A | 30A | 325A | 35A | 375A |
|------------|------|-----|------|-----|------|-----|------|-----|------|
| L | 15 | 20 | 21 | 25 | 27.5 | 30 | 32.5 | 35 | 37.5 |
| F | 4.5 | 7 | 7 | 7 | 12 | 12 | 12 | 12 | 12 |

**15 mm is not available for RV110CF-40 and RV110CTF-40 models.

| | |
|---|--|
| RV110(T)F-20E1(21E1)-(L)A | RV110(T)F-40E1-(L)A |
|  |  |
| RV110(T)F-20E1(21E1)-(L)AW | RV110(T)F-40E1-(L)AW |
|  |  |

| Order Code | 125A | 135A | 15A | 175A | 20A | 225A | 25A | 275A | 29A | 30A |
|------------|-------|-------|------|-------|------|-------|------|-------|------|------|
| | 125AW | 135AW | 15AW | 175AW | 20AW | 225AW | 25AW | 275AW | 29AW | 30AW |
| L | 12.5 | 13.5 | 15 | 17.5 | 20 | 22.5 | 25 | 27.5 | 29 | 30 |
| F | 7 | 7 | 7 | 7* | 12 | 12 | 12 | 12 | 12 | 12 |

**17.5mm with F = 7mm is only available for A type, not AW type.

[Back to top](#)

11mm Snap-In, Insulated and Metal Shaft

■ B Plastic Shaft Type

| | | |
|--|--|---|
| RV110F-20 (21)-(L)B RV110TF-20 (21)-(L)B | RV110F-40-(L)B RV110TF-40-(L)B RV112F-40-(L)B | RV110CF-40-(L)B RV110TCF-40-(L)B |
|  |  |  |

| Order Code | *15B | 20B | 225B | 25B | 275B | 30B | 375B |
|------------|------|-----|------|-----|------|-----|------|
| L | 15 | 20 | 21 | 25 | 27.5 | 30 | 37.5 |
| T | 6 | 7 | 7 | 12 | 12 | 12 | 12 |

**15 mm shaft is not available for RV110CF-40 and RV110CTF-40 models.

| | |
|---|--|
| RV110F-20E1(21E1)-(L)B RV110TF-20E1(21E1)-(L)B | RV110F-40E1-(L)B RV110TF-40E1-(L)B |
|  |  |

| Order Code | 125B | 15B | 175B | 20B | 225B | 25B |
|------------|------|-----|--------|-----|------|-----|
| L | 12.5 | 15 | 17.5 | 20 | 22.5 | 25 |
| T | 7 | 7 | 7 12 | 12 | 12 | 12 |

Design and specifications presented here are for the standard parts only. Please kindly contact us for your special requests and ask for the current technical specifications before purchase and/or use.

[Back to top](#)

Mouser Electronics

Authorized Distributor

Click to View Pricing, Inventory, Delivery & Lifecycle Information:

Alpha (Taiwan):

[RV110F-40-15A-A10K](#) [RV110F-40-20B-A10K](#) [RV110F-20-15B-A10K](#) [RV110F-40-15B-A10K-0020](#) [RV110F-20-15B-B10K](#) [RV110F-20-15A-B100K](#) [RV110F-40-15A-B100K](#) [RV110F-20-15B-A100K](#) [RV110F-20-15B-B100K](#) [RV110F-40-15B-B100K](#) [RV110F-40-15A-B10K](#) [RV110F-20-15A-A100K](#) [RV110F-40-20B-B10K](#) [RV110F-40-15B-B10K](#) [RV110F-40-15A-A100K](#) [RV110F-40-20B-A100K](#) [RV110F-20-15A-B10K](#) [RV110F-20-15A-A10K](#) [RV110F-40-15B-A100K](#) [RV110F-20-20B-A10K](#) [RV110F-20-20B-A100K](#) [RV110F-20-20B-B10K](#) [RV110F-20-20B-B100K](#) [RV110F-40-20B-B100K](#)

Данный компонент на территории Российской Федерации

Вы можете приобрести в компании MosChip.

Для оперативного оформления запроса Вам необходимо перейти по данной ссылке:

<http://moschip.ru/get-element>

Вы можете разместить у нас заказ для любого Вашего проекта, будь то серийное производство или разработка единичного прибора.

В нашем ассортименте представлены ведущие мировые производители активных и пассивных электронных компонентов.

Нашей специализацией является поставка электронной компонентной базы двойного назначения, продукции таких производителей как XILINX, Intel (ex.ALTERA), Vicor, Microchip, Texas Instruments, Analog Devices, Mini-Circuits, Amphenol, Glenair.

Сотрудничество с глобальными дистрибьюторами электронных компонентов, предоставляет возможность заказывать и получать с международных складов практически любой перечень компонентов в оптимальные для Вас сроки.

На всех этапах разработки и производства наши партнеры могут получить квалифицированную поддержку опытных инженеров.

Система менеджмента качества компании отвечает требованиям в соответствии с ГОСТ Р ИСО 9001, ГОСТ РВ 0015-002 и ЭС РД 009

Офис по работе с юридическими лицами:

105318, г.Москва, ул.Щербаковская д.3, офис 1107, 1118, ДЦ «Щербаковский»

Телефон: +7 495 668-12-70 (многоканальный)

Факс: +7 495 668-12-70 (доб.304)

E-mail: info@moschip.ru

Skype отдела продаж:

moschip.ru

moschip.ru_4

moschip.ru_6

moschip.ru_9