

For housing types and dim A and B see sheet 4

Part number:  
10056100-1YZABCILF

X = PLATING  
I=TELCORDIA CO (see note 2 sheet 5)

YZ = HOUSING TYPE  
01 = 2 wall narrow body  
04 = 4 wall narrow body  
05 = 2 wall wide body (STANDARD VERSION)  
08 = 4 wall wide body

ABC = PIN LAYOUT  
001 = standard layout (no detect pin)  
xxx = other versions see sheet 2

LF = Lead Free  
LF = Lead free product (see note 8 sheet 5)  
no suffix = Non lead free: available upon special request

2 WALL WIDE BODY VERSION AS SHOWN

spec ref	RELEASE	dr	Matthew Cheong	2006/08/15	projection	mm	size	A3	scale	2:1
tolerance std	TOLERANCES UNLESS OTHERWISE SPECIFIED	eng	K R Mahoharan	2012/07/23			ecn no	ELX-S-012244-1		
ISO 406 ISO 1101		chr	-						rel level	Released
surface	linear	appr	Chen-Hong Tan	2012/10/12	product family	AirMax VS	dwg no	10056100		rev
ISO 1302	angular								F	



www.fci.com

title AirMax VS VERTICAL HEADER  
4 pair, 120 pos, 2mm, 10 IMLA

cat. no. - Product - Customer Drw sheet 1 of 5



Copyright FCI.

\* Detection pin of 3.9mm possible on standard positions H5  
 For other detection pin and options please consult FCI.

Partnumber \ Pinlayout	5.6mm Longpins (typ gnd)	3.9mm * Short pin (typ detect)	4.6mm Otherpins (typ sign)
10056100-1YZ0011(LF)	F1,F3,F5,F7,F9 G2,G4,G6,G8,G10	-	All other positions
10056100-1YZ0021(LF)	-	-	All positions
10056100-1YZ0031(LF)	F1,F3,F5,F7,F9 G2,G4,G6,G8,G10	H5	All other positions
10056100-1YZ0032(LF)	F1,F3,F5,F7,F9 G2,G4,G6,G8,G10	H5 (See Note 7)	All other positions



Copyright FCI.

spec ref	RELEASE	dr	Matthew Cheong	2006/08/15	projection	mm	size	A3	scale	2:1
tolerance std	TOLERANCES UNLESS OTHERWISE SPECIFIED	eng	K R Mahoharan	2012/07/23		← →	ecn no	ELX-S-012244-1		
ISO 406 ISO 1101		chr	-	-			product family	AirMax VS	rel level	Released
surface		linear	0.X	±		Title	AirMax VS VERTICAL HEADER	dwg no	10056100	rev
ISO 1302	angular	0°	±°	www.fci.com						

1

2

3

4

A

NARROW BODY

WIDE BODY

A

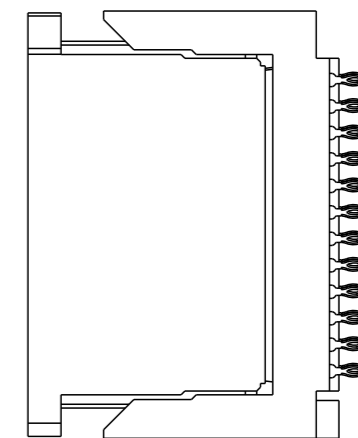
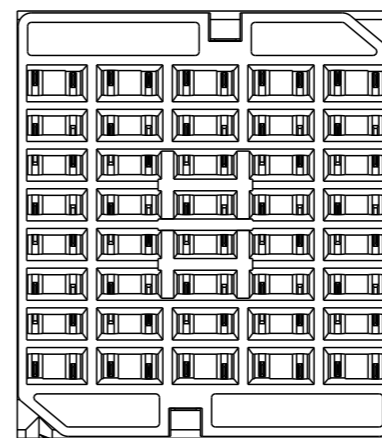
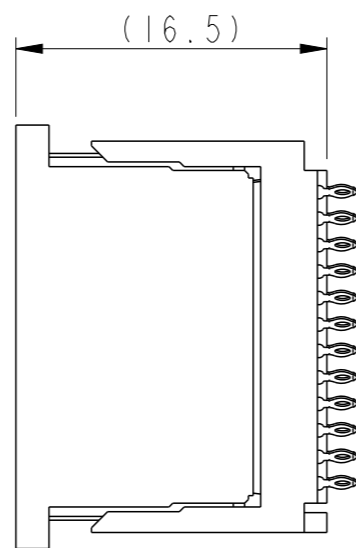
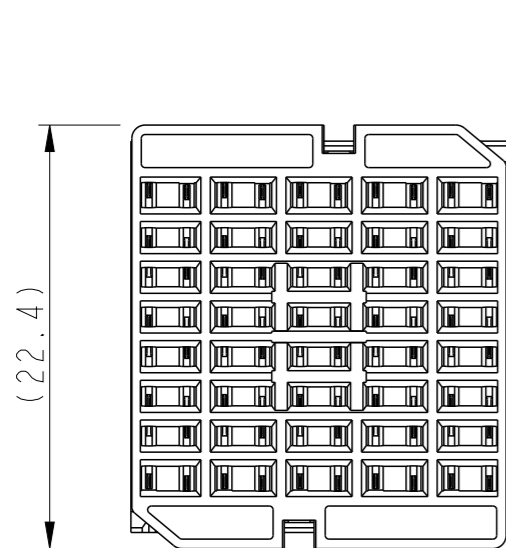

B

B

Triangle indicates position A1.  
SEE NOTE 12.

Triangle indicates position A1.  
SEE NOTE 12.

SEE NOTE 14.

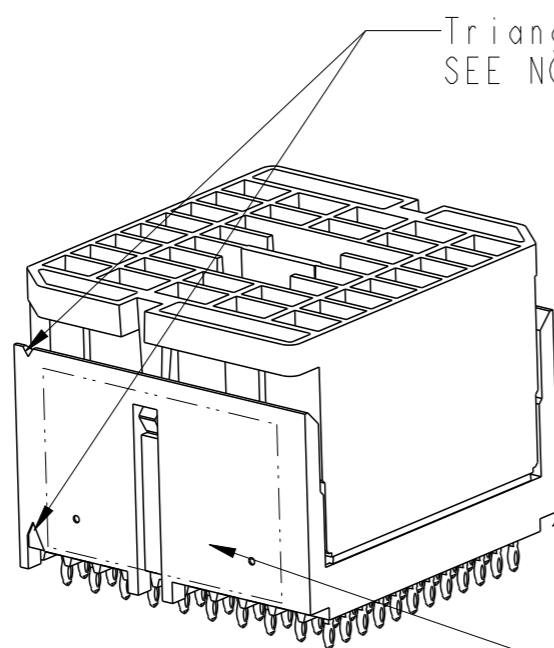

cut-out at opposite side  
of A1 indicator.  
SEE NOTE 12.

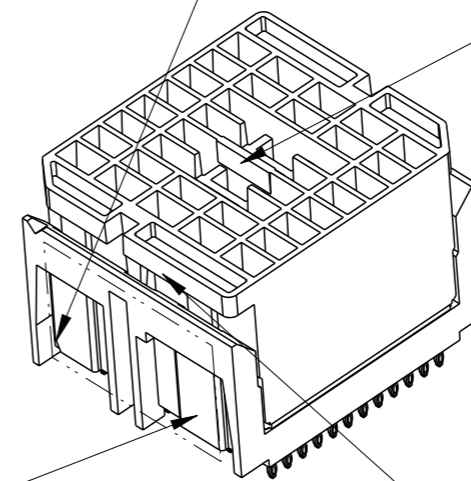

SEE NOTE 13.

NOTE 5 & 12

C

C



Copyright FCI.

D

D

spec ref	RELEASE	dr	Matthew Cheong	2006/08/15	projection	mm	size	A3	scale	2:1				
tolerance std	TOLERANCES UNLESS OTHERWISE SPECIFIED	eng	K R Mahoharan	2012/07/23		←→	ecn no	AirMax VS	rel level	Released				
ISO 406 ISO 1101		chr	-	-							product family			
surface	linear	0.X	±		title	AirMax VS VERTICAL HEADER	dwg no	10056100	rev	F				
ISO 1302	0.XX	±	www.fci.com								cat. no.	-	Product - Customer Drw	sheet 3 of 5
	angular	0°												

2

3

PDS: Rev :F

STATUS:Released

Printed: Oct 16, 2012

1

2

3

4

NARROW BODY

WIDE BODY

10056100 - 101ABCI

10056100 - 104ABCI

10056100 - 105ABCI

10056100 - 108ABCI

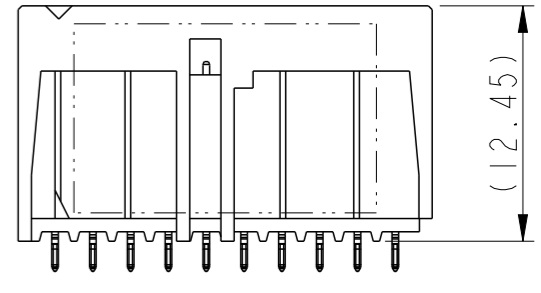
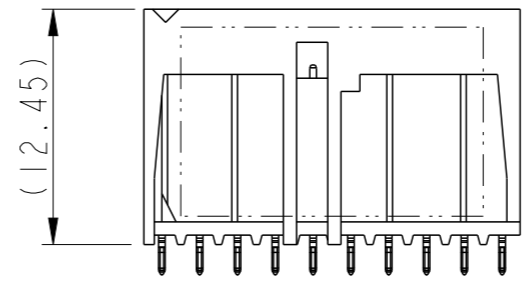
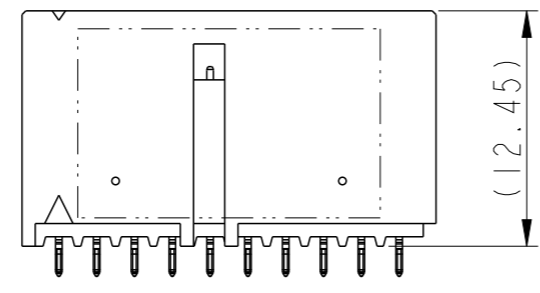
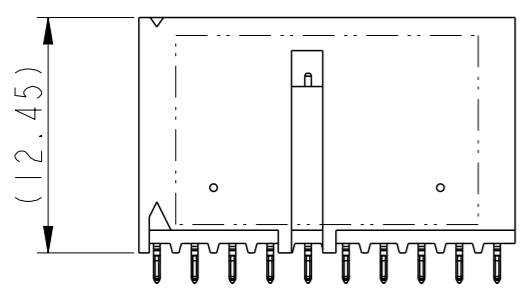
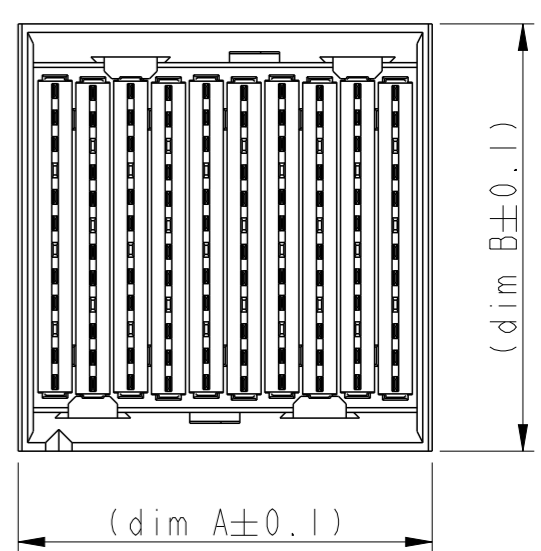
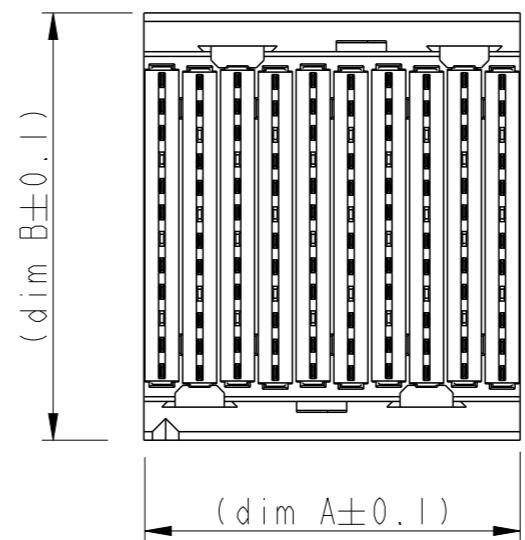
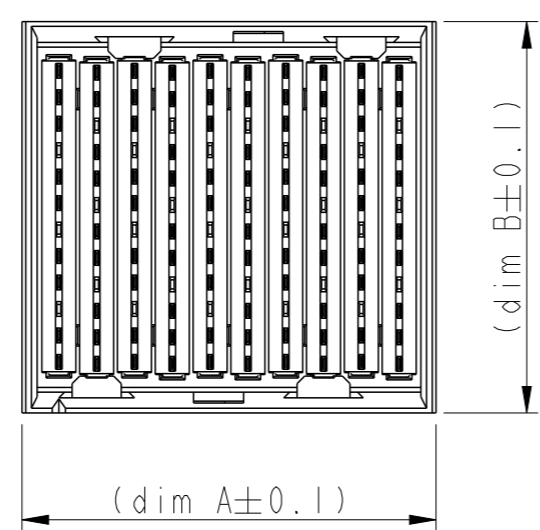
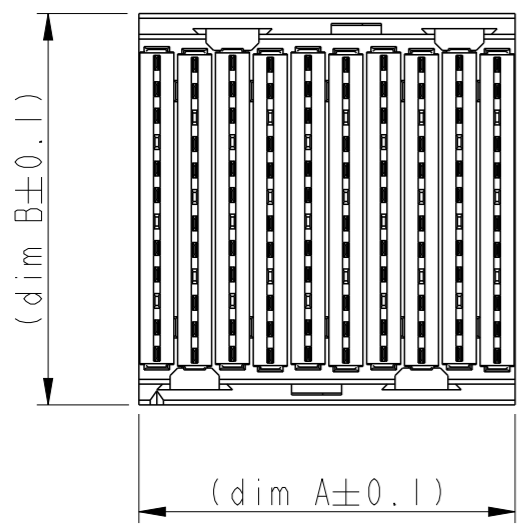

PN / dim	A	B
10056100-101ABCI(LF)	19.9	20.7
10056100-104ABCI(LF)	21.9	20.7
10056100-105ABCI(LF)	19.9	22.6
10056100-108ABCI(LF)	21.9	22.6

spec ref	RELEASE	dr	Matthew Cheong	2006/08/15	projection	mm	size	A3	scale	2:1			
tolerance std	TOLERANCES UNLESS OTHERWISE SPECIFIED	eng	K R Mahoharan	2012/07/23			ecn no	ELX-S-012244-1	rel level	Released			
ISO 406		chr	-	-									
ISO 1101		appr	Chen-Hong Tan	2012/10/12							product family	AirMax VS	
surface	linear	0.X	±		title AirMax VS VERTICAL HEADER 4 pair, 120 pos, 2mm, 10 IMLA	dwg no 10056100	rev F	Product - Customer Drw		sheet 4 of 5			
ISO 1302	angular	0°	±°					cat. no.	-	PDS: Rev :F		STATUS:Released	Printed: Oct 16, 2012



Copyright FCI.

1

2

3

4

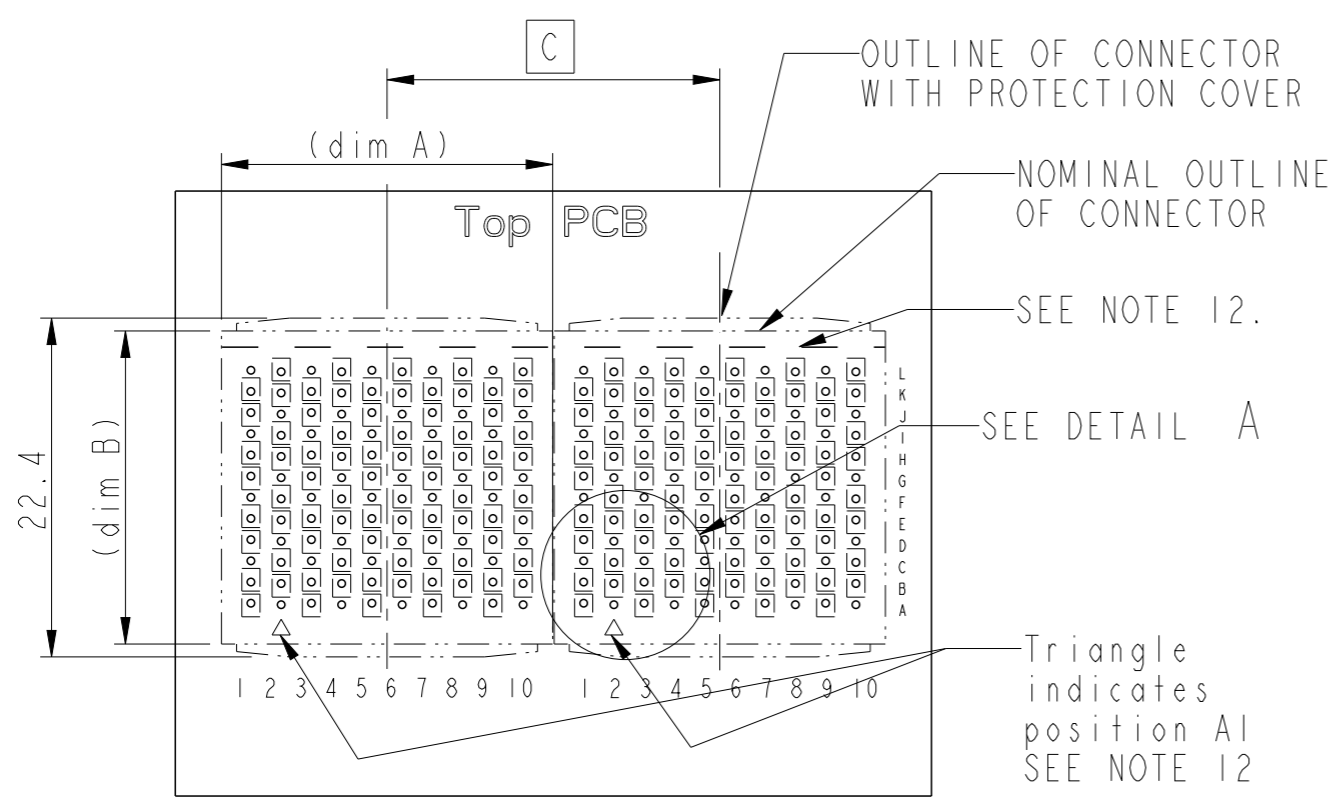

RECOMMENDED PCB LAYOUT FOR DIFFERENTIAL APPLICATIONS COMPONENT SIDE (TWO ADJACENT FOOTPRINTS SHOWN)

PN \ dim	A	B	C
10056100-101ABC1(LF)	19.9	20.7	20
10056100-104ABC1(LF)	21.9	20.7	22
10056100-105ABC1(LF)	19.9	22.6	20
10056100-108ABC1(LF)	21.9	22.6	22

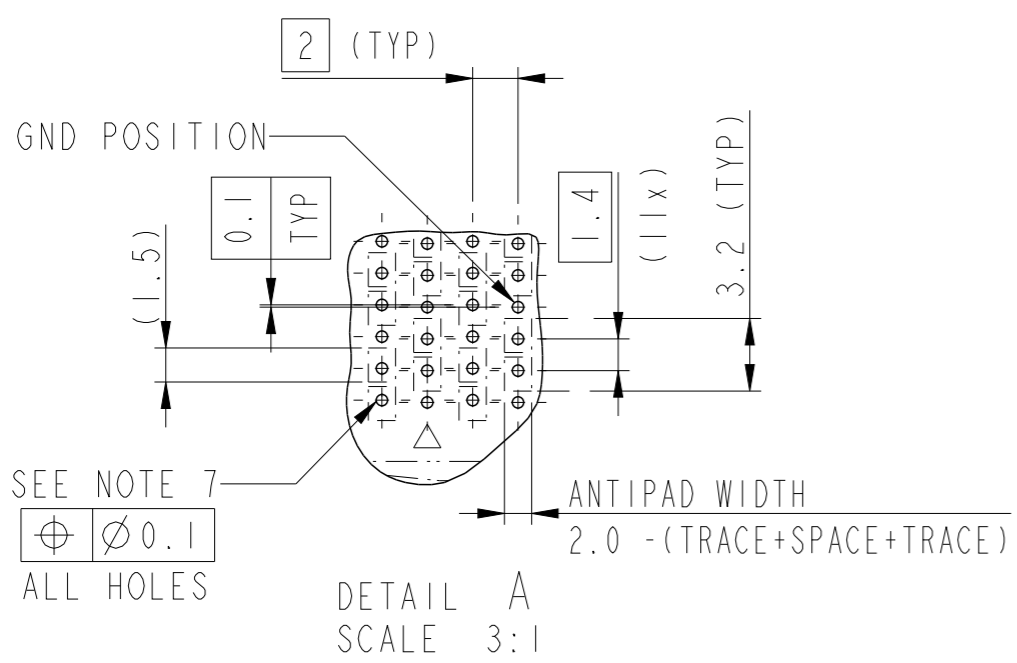

F

NOTES:

- CONNECTOR MATERIALS:  
HOUSING : HIGH TEMP THERMOPLASTIC, NATURAL, UL94V-0  
PROTECTION COVER : HIGH TEMP THERMOPLASTIC, BLACK, UL94V-0  
IMLA PLASTIC: HIGH TEMP THERMOPLASTIC, BLACK UL94V-0  
CONTACT: COPPER ALLOY
- CONTACT PLATING:  
SEPARABLE INTERFACE: PERFORMANCE-BASED PLATING, QUALIFIED TO MEET THE REQUIREMENTS OF FCI PRODUCT SPECIFICATION GS-12-239, INCLUDING TELCORDIA GR-1217-CORE (NOV 1995)  
CENTRAL OFFICE TEST SEQUENCE.  
PRESS-FIT TAILS: TIN-LEAD (NON LEAD FREE) OR TIN OVER NICKEL (LEAD FREE)
- PRODUCT SPECIFICATION: GS-12-239.
- APPLICATION SPECIFICATION: GS-20-035. FLATROCK INSERTION INTO PCB BY PUSHING ON TOP OF SURFACE PROTECTION COVER
- PRODUCT MARKING, (PARTNUMBER & LOTCODE).
- PROTECTION COVER MUST BE REMOVED BEFORE MATING WITH RECEPTACLE CONNECTOR
- SEE CUSTOMER DRAWING 10045979 FOR INFORMATION ON PCB HOLE DIAMETER AND PLATING OPTIONS.
- LEAD FREE PARTNUMBERS MEETS THE EUROPEAN UNION DIRECTIVE AS DESCRIBED IN GS-22-008, SUB CLAUSE 3.2
- THE HOUSING SHOULD WITHSTAND EXPOSURE TO 260°C PEAK TEMPERATURE FOR 40 SECONDS IN A CONVECTION, INFRA-RED OR VAPOR PHASE REFLOW OVEN.
- PACKAGE PER GS-14-1086 AND GS-14-920 LEAD FREE LABELING SPEC.
- THERE IS NO GROUND BUSSING WITHIN THE CONNECTOR SYSTEM.
- IT IS RECOMMENDED TO PUT THIS VISIBLE LINE AND THE A1 INDICATION (TRIANGLE) ON THE PCB TO INDICATE PROPER ORIENTATION. OTHER VISIBLE POLARIZATION MARKS ARE A1 INDICATOR AND PRINTING SIDE. (SEE SHEET 3)
- GRIPPING FEATURE TO REMOVE PROTECTION COVER BY FINGERS.
- GRIPPING FEATURE TO REMOVE PROTECTION COVER BY STANDARD PLIERS.
- A  SYMBOL WILL BE NEXT TO ANY DIMENSION, VIEW OR NOTE WHICH HAS BEEN MODIFIED WITH THE CURRENT DRAWING REVISION.
- THIS IS A CUSTOMER SPECIAL HOUSING TO BE LAZER MARKED WITH A SINGLE STRIP (1).

F

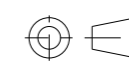

Copyright FCI.

spec ref	RELEASE	dr	Matthew Cheong	2006/08/15	projection	mm	size	A3	scale	2:1	
tolerance std	TOLERANCES UNLESS OTHERWISE SPECIFIED	eng	K R Mahoharan	2012/07/23		mm	A3	ecn no	ELX-S-012244-1	rel level	Released
ISO 406 ISO 1101		chr	-	-							
surface	linear	appr	Chen-Hong Tan	2012/10/12	product family	AirMax VS	dwg no		10056100	rev	F
ISO 1302	angular	www.fci.com		cat. no.	Product - Customer Drw		sheet 5 of 5				

## Данный компонент на территории Российской Федерации

### Вы можете приобрести в компании MosChip.

Для оперативного оформления запроса Вам необходимо перейти по данной ссылке:

<http://moschip.ru/get-element>

Вы можете разместить у нас заказ для любого Вашего проекта, будь то серийное производство или разработка единичного прибора.

В нашем ассортименте представлены ведущие мировые производители активных и пассивных электронных компонентов.

Нашей специализацией является поставка электронной компонентной базы двойного назначения, продукции таких производителей как XILINX, Intel (ex.ALTERA), Vicor, Microchip, Texas Instruments, Analog Devices, Mini-Circuits, Amphenol, Glenair.

Сотрудничество с глобальными дистрибьюторами электронных компонентов, предоставляет возможность заказывать и получать с международных складов практически любой перечень компонентов в оптимальные для Вас сроки.

На всех этапах разработки и производства наши партнеры могут получить квалифицированную поддержку опытных инженеров.

Система менеджмента качества компании отвечает требованиям в соответствии с ГОСТ Р ИСО 9001, ГОСТ РВ 0015-002 и ЭС РД 009

### Офис по работе с юридическими лицами:

105318, г.Москва, ул.Щербаковская д.3, офис 1107, 1118, ДЦ «Щербаковский»

Телефон: +7 495 668-12-70 (многоканальный)

Факс: +7 495 668-12-70 (доб.304)

E-mail: [info@moschip.ru](mailto:info@moschip.ru)

Skype отдела продаж:

moschip.ru

moschip.ru\_4

moschip.ru\_6

moschip.ru\_9