



## MIC2589/MIC2595

### Single-Channel, Negative High-Voltage Hot Swap Power Controller/Sequencer

#### General Description

The MIC2589 and MIC2595 are single-channel, negative voltage hot swap controllers designed to address the need for safe insertion and removal of circuit boards into “live” system backplanes, while using few external components. The MIC2589/MIC2589R and the MIC2595/MIC2595R are each available in 14-pin SOIC packaging and work in conjunction with an external N-Channel MOSFET for which the gate drive is controlled to provide inrush current limiting and output voltage slew-rate control. Overcurrent fault protection is also provided via a programmable overcurrent threshold and filter. Very fast fault response is provided to ensure that system power supplies maintain regulation even during output short circuits. These controllers offer two responses to a circuit breaker fault condition: the MIC2589 and MIC2595 latch the circuit breaker’s output off when the overcurrent threshold interval is exceeded and the overcurrent filter times out while the MIC2589R and MIC2595R automatically attempt to restart at a fixed duty cycle after a current limit fault. A primary Power-Good signal and two secondary (delayed and staggered) Power-Good signals are provided to indicate that the output voltage is within its valid operating range. These signals can be used to perform an all-at-once or a sequenced enabling of one or more DC-DC power modules.

All support documentation can be found on Micrel’s web site at [www.micrel.com](http://www.micrel.com).

#### Features

- Provides safe insertion and removal from live –48V (nominal) backplanes
- Operates from –19V to –80V
- Fast responding circuit breaker (<1µs) to short circuit conditions
- User-programmable overcurrent detector response time
- Electronic circuit breaker function:
  - Output latch OFF (MIC2589/MIC2595)
  - Output auto-retry (MIC2589R/MIC2595R)
- Active current regulation to control inrush currents
- Programmable undervoltage and overvoltage lockouts (MIC2589/MIC2589R)
- Programmable UVLO hysteresis (MIC2595/MIC2595R)
- Staggered ‘Power-Good’ output signals provide load sequencing
  - Active-HIGH (-1)
  - Active-LOW (-2)

#### Applications

- Central office switching
- –48V power distribution
- Distributed power systems
- AdvancedTCA

#### Ordering Information

Part Number		PWRGD Polarity	Lockout Functions	Circuit Breaker Function	Package
Standard	Pb-Free				
MIC2589-1BM	MIC2589-1YM	Active-High	Programmable UVLO & OVLO	Latched Off	14-Pin SOIC
MIC2589-2BM	MIC2589-2YM	Active-Low	Programmable UVLO & OVLO	Latched Off	14-Pin SOIC
MIC2589R-1BM	MIC2589R-1YM	Active-High	Programmable UVLO & OVLO	Auto Retry	14-Pin SOIC
MIC2589R-2BM	MIC2589R-2YM	Active-Low	Programmable UVLO & OVLO	Auto Retry	14-Pin SOIC
MIC2595-1BM	MIC2595-1YM	Active-High	Programmable UVLO Hysteresis	Latched Off	14-Pin SOIC
MIC2595-2BM	MIC2595-2YM	Active-Low	Programmable UVLO Hysteresis	Latched Off	14-Pin SOIC
MIC2595R-1BM	MIC2595R-1YM	Active-High	Programmable UVLO Hysteresis	Auto Retry	14-Pin SOIC
MIC2595R-2BM	MIC2595R-2YM	Active-Low	Programmable UVLO Hysteresis	Auto Retry	14-Pin SOIC

## Typical Applications

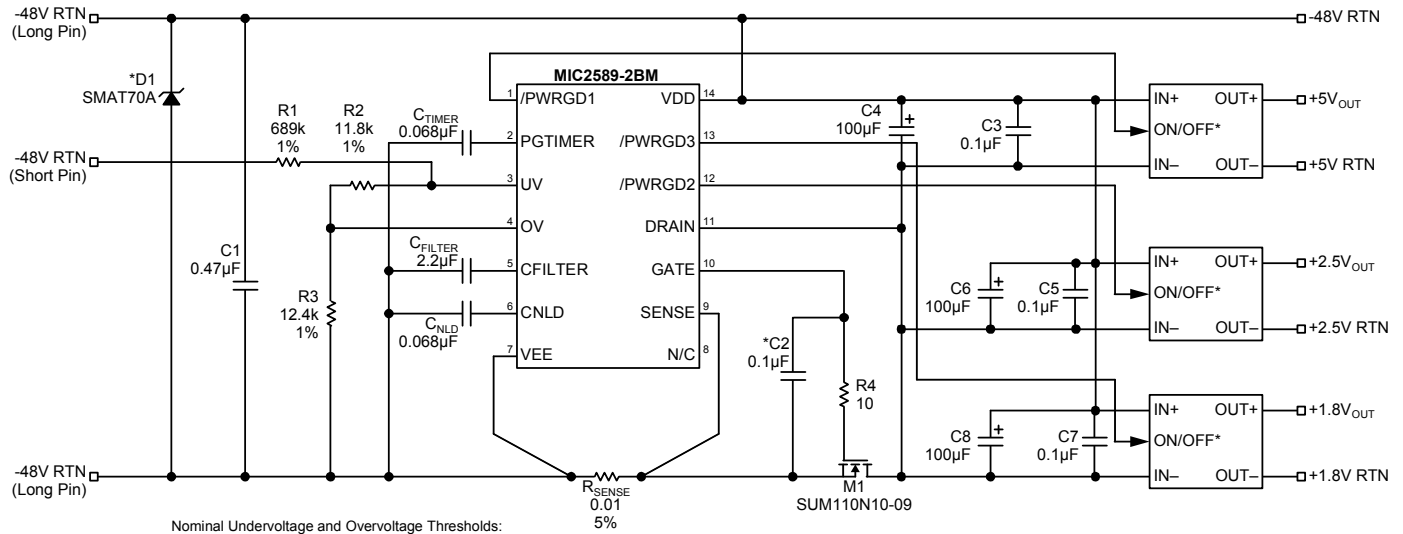

Nominal Undervoltage and Overvoltage Thresholds:

$V_{UV} = 36.5V$

$V_{OV} = 71.2V$

Overcurrent Timer Delay

$t_{OL} \approx 30ms$

\*Optional components (See Functional Description and Applications Information for more details)

#An external pull-up resistor for the power-good signal is necessary for DC-DC convertors (and all other load modules) not equipped with an internal pull-up impedance

### Pin Configuration

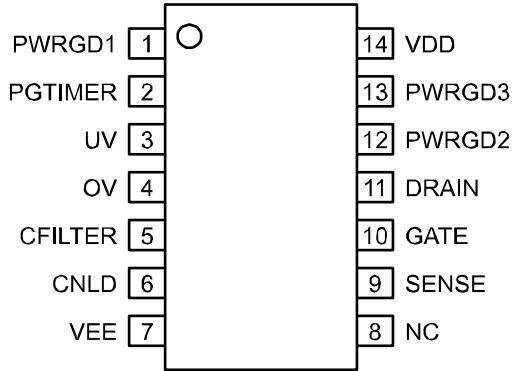

**14-Pin SOIC**  
**MIC2589-1BM**  
**MIC2589R-1BM**  
**MIC2589-1YM**  
**MIC2589R-1YM**

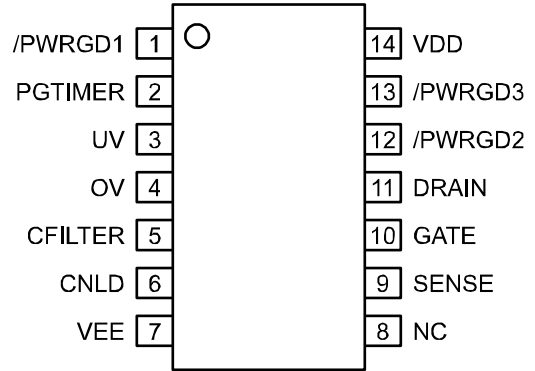

**14-Pin SOIC**  
**MIC2589-2BM**  
**MIC2589R-2BM**  
**MIC2589-2YM**  
**MIC2589R-2YM**

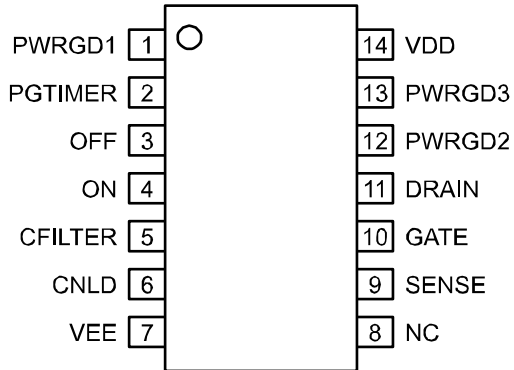

**14-Pin SOIC**  
**MIC2595-1BM**  
**MIC2595R-1BM**  
**MIC2595-1YM**  
**MIC2595R-1YM**

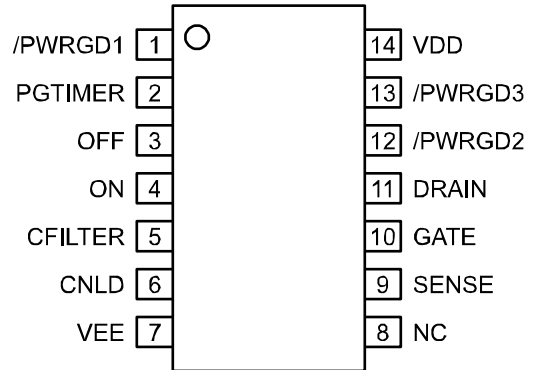

**14-Pin SOIC**  
**MIC2595-2BM**  
**MIC2595R-2BM**  
**MIC2595-2YM**  
**MIC2595R-2YM**

## Pin Description

Pin Number	Pin Name	Pin Function
1	PWRGD1 (MIC25XX-1) Active High  /PWRGD1 (MIC25XX-2) Active Low	Power-Good Output 1: Asserted when the voltage on the DRAIN pin ( $V_{DRAIN}$ ) is within $V_{PGTH}$ of VEE, indicating that the output voltage is within proper specifications. For the MIC2589-1 and MIC2595-1, PWRGD1 will be high impedance when $V_{DRAIN}$ is less than $V_{PGTH}$ , and will pull-down to $V_{DRAIN}$ when $V_{DRAIN}$ is greater than $V_{PGTH}$ . For the MIC2589-2 and MIC2595-2, /PWRGD1 will pull-down to $V_{DRAIN}$ when $V_{DRAIN}$ is less than $V_{PGTH}$ , and will be high-impedance when $V_{DRAIN}$ is greater than $V_{PGTH}$ .
2	PGTIMER	A capacitor connected from this pin to VEE sets the time interval between assertions of PWRGD2 (or /PWRGD2) and PWRGD3 (or /PWRGD3) relative to PWRGD1 (or /PWRGD1). See the "Functional Description" for further detail.
3	UV (MIC2589 and MIC2589R)	Undervoltage Threshold Input: When the voltage at the UV pin is less than the $V_{UVL}$ threshold, the GATE pin is immediately pulled low by an internal 100 $\mu$ A current pull-down. The UV pin is also used to cycle the device off and on to reset the circuit breaker. Taken together, the OV and UV pins form a window comparator that defines the limits of $V_{EE}$ to deliver power to the load.
3	OFF (MIC2595 and MIC2595R)	Turn-Off Threshold: When the voltage at the OFF pin is less than the $V_{OFFL}$ threshold, the GATE pin is immediately pulled low by an internal 100 $\mu$ A current pull-down. The OFF pin is also used to cycle the device off and on to reset the circuit breaker. Taken together, the ON and OFF pins provide programmable hysteresis for the MIC2595 to be enabled.
4	OV (MIC2589 and MIC2589R)	Overvoltage Threshold Input: When the voltage at the OV pin is greater than the $V_{OVH}$ threshold, the GATE pin is immediately pulled low by an internal 100 $\mu$ A current pull-down.
4	ON (MIC2595 and MIC2595R)	Turn-On Threshold: At initial system power-up or after the part has been shut off by the OFF pin, the voltage on the ON pin must be above the $V_{ONH}$ threshold in order for the MIC2595 to be enabled.
5	CFILTER	Current Limit Response Timer: A capacitor connected between this pin and VEE provides filtering against nuisance tripping of the circuit breaker by setting a time delay, $t_{FLT}$ , for which an overcurrent event must last prior to signaling a fault condition and latching the output off. The minimum time for $t_{FLT}$ will be the time it takes for the output (capacitance) to charge to VEE during start-up. This pin is held to VEE with a 3 $\mu$ A current pull-down when no current limit condition exists. See the "Functional Description" for further details.
6	CNLD	No-Load Detect Timer: The absence of a load for the MIC2589/MIC2589R is defined for any current load that is less than 20% of the full-scale current limit (i.e., $0.20 \times I_{LIM}$ ). A capacitor between CNLD and VEE sets the filter delay, $t_{NLD}$ , for a load current that is 80% (or greater) below the full-scale current limit before the circuit breaker is tripped.
7	VEE	Negative Supply Voltage Input: Connect the negative, or low side, terminal of the input power supply.
8	NC	No Internal Connection
9	SENSE	Circuit Breaker Sense Input: A resistor between this pin and VEE sets the current limit trip point for the circuit. When the current limit threshold of $IR = 50\text{mV}$ is exceeded for $t_{FLT}$ , the circuit breaker is tripped and the GATE pin is immediately pulled low by $I_{GATEOFF}$ . Toggling UV or OV will reset the circuit breaker. In order to disable the circuit breaker (i.e., eliminate overcurrent $V_{SENSE}-V_{EE}$ protection), connect (short) the SENSE pin to VEE and also connect the CNLD pin to VEE to disable the no-load detection feature.
10	GATE	Gate Drive Output: Connects to the Gate of an N-Channel MOSFET.
11	DRAIN	Drain Sense Input: Connects to the Drain of an N-Channel MOSFET.

**Pin Description (cont.)**

Pin Number	Pin Name	Pin Function
12	PWRGD2 (MIC25XX-1)	Power-Good Output 2: Asserted when the following is true: (PWRGD1 = Asserted) AND (Time after Assertion of PWRGD1 = Time PWRGD2, as programmed by the capacitor on PGTIMER). Once PWRGD1 is asserted, the PGTIMER pin begins to charge and PWRGD2 will assert when PGTIMER crosses the PWRGD2 threshold ( $V_{THRESH(PG2)} = 0.63V$ , typical). Also see PWRGD1 and PGTIMER pin descriptions
12	/PWRGD2 (MIC25XX-2)	/Power-Good Output 2: Asserted when the following is true: (/PWRGD1 = Asserted) AND (Time after Assertion of /PWRGD1 = Time /PWRGD2, as programmed by the capacitor on PGTIMER). Once /PWRGD1 is asserted, the PGTIMER pin begins to charge and /PWRGD2 will assert when PGTIMER crosses the /PWRGD2 threshold ( $V_{THRESH(PG2)} = 0.63V$ , typical). Also see /PWRGD1 and PGTIMER pin descriptions.
13	PWRGD3 (MIC25XX-1)	Power-Good Output 3: Asserted when the following is true: (PWRGD1 = Asserted) AND (Time after Assertion of PWRGD1 = Time PWRGD3, as programmed by the capacitor on PGTIMER). Once PWRGD1 is asserted, the PGTIMER pin begins to charge and PWRGD3 will assert when PGTIMER crosses the PWRGD3 threshold ( $V_{THRESH(PG3)} = 1.15V$ , typical). Also see PWRGD1 and PGTIMER pin descriptions.
13	/PWRGD3 (MIC25XX-2)	/Power-Good Output 3: Open Collector. Asserted when the following is true: (/PWRGD1 = Asserted) AND (Time after Assertion of /PWRGD1 = Time /PWRGD3, as programmed by the capacitor on PGTIMER). Once /PWRGD1 is asserted, the PGTIMER pin begins to charge and /PWRGD3 will assert when PGTIMER crosses the /PWRGD3 threshold ( $V_{THRESH(PG3)} = 1.15V$ , typical). Also see /PWRGD1 and PGTIMER pin descriptions.
14	VDD	Positive Supply Input: Connect to the positive, or high side, terminal of the input power supply.

### Absolute Maximum Ratings<sup>(1)</sup>

(All voltages are referred to  $V_{EE}$ )  
 Supply Voltage ( $V_{DD} - V_{EE}$ ) ..... -0.3V to 100V  
 DRAIN, PWRGD pins..... -0.3V to 100V  
 GATE pin..... -0.3V to 12.5V  
 SENSE, OV, UV, ON, OFF pins..... -0.3V to 6V  
 Lead Temperature (soldering)  
     Standard Package (-xBM)  
     (IR Reflow, Peak Temperature .....240°C +0°C/-5°C  
     Pb-Free Package (-xYM)  
     (IR Reflow, Peak Temperature .....260°C +0°C/-5°C  
 ESD Ratings<sup>(3)</sup>  
     Human Body Model.....2kV  
     Machine Model .....100V

### Operating Ratings<sup>(2)</sup>

Supply Voltage ( $V_{DD}-V_{EE}$ ) ..... +19V to +80V  
 Ambient Temperature Range ( $T_A$ ).....-40°C to 85°C  
 Junction Temperature ( $T_J$ ).....125°C  
 Package Thermal Resistance  
     SOIC ( $\theta_{JA}$ ) ..... 120°C/W

### DC Electrical Characteristics<sup>(4)</sup>

$V_{DD} = 48V$ ,  $V_{EE} = 0V$ ,  $T_A = 25^\circ C$ , unless otherwise noted. **Bold** indicates specifications apply over the full operating temperature range of -40°C to 85°C.

Symbol	Parameter	Condition	Min	Typ	Max	Units
$V_{DD} - V_{EE}$	Supply Voltage		<b>19</b>		<b>80</b>	V
$I_{DD}$	Supply Current			4	<b>6</b>	mA
$V_{TRIP}$	Circuit Breaker Trip Voltage	GATE Drive Voltage, ( $V_{GATE} - V_{EE}$ )	<b>40</b>	50	<b>60</b>	mV
$I_{NLDTH}$	No-Load Detect Threshold (% of full-scale current limit)	$I_{OUT}$ decreasing		20		%
		$I_{OUT}$ increasing		22		%
$I_{NLDHYS}$	No-Load Detect Threshold Hysteresis			2		%
$V_{CNLD}$	No-Load Detect Timer High Threshold Voltage		<b>1.17</b>	1.24	<b>1.33</b>	V
$I_{CNLD}$	No-Load Detect Timer Capacitor Charge Current <sup>(5)</sup>		10	25	40	$\mu A$
$V_{GATE}$	GATE Drive Voltage, ( $V_{GATE} - V_{EE}$ )	$15V \leq (V_{DD} - V_{EE}) \leq 80V$	<b>9</b>	10	<b>11</b>	V
$I_{GATEON}$	GATE Pin Pull-Up Current	$V_{GATE} = V_{EE}$ to 8V $19V \leq (V_{DD} - V_{EE}) \leq 80V$	<b>30</b>	45	<b>60</b>	$\mu A$
$I_{SENSE}$	SENSE Pin Current	$V_{SENSE} = 50mV$		0.2		$\mu A$
$I_{GATEOFF}$	GATE Pin Sink Current	$(V_{SENSE} - V_{EE}) = 100mV$ $V_{GATE} = 2V$	<b>100</b>	240		mA
$I_{CFILTER}$	CFILTER Pin Charge Current	$(V_{SENSE} - V_{EE}) > V_{TRIP}$ $V_{CFILTER} = 0.75V$ $V_{GATE} = 3V$	<b>65</b>	95	<b>135</b>	$\mu A$
	CFILTER Discharge Current	$(V_{SENSE} - V_{EE}) < V_{TRIP}$ $V_{CFILTER} = 0.75V$ $V_{GATE} = 3V$	<b>2</b>	4	<b>6</b>	$\mu A$
$V_{CFILTER(TRIP)}$	High Threshold Voltage Overcurrent Detect Timer	$(V_{SENSE} - V_{EE}) > V_{TRIP}$	<b>1.17</b>	1.25	<b>1.33</b>	V
$V_{CFILTER(RETRY)}$	Voltage on CFILTER (decreasing) to Trigger Auto-Retry (MIC2589R and MIC2595R)		<b>0.17</b>	0.22	<b>0.25</b>	V
$I_{PGTIMER}$	PGTIMER Charge Current	Voltage on PGTIMER = 0.75 V	<b>30</b>	45	<b>80</b>	$\mu A$

## Notes:

1. Exceeding the absolute maximum rating may damage the device.
2. The device is not guaranteed to function outside its operating rating.
3. Devices are ESD sensitive. Handling precautions recommended. Human body model, 1.5k in series with 100pF.
4. Specification for packaged product only.
5. Not 100% tested. Parameters are guaranteed by design.

**DC Electrical Characteristics<sup>(6)</sup>**

$V_{DD} = 48V$ ,  $V_{EE} = 0V$ ,  $T_A = 25^\circ C$ , unless otherwise noted. **Bold** indicates specifications apply over the full operating temperature range of  $-40^\circ C$  to  $85^\circ C$ .

Symbol	Parameter	Condition	Min	Typ	Max	Units
$V_{THRESH(PG2)}$	PGTIMER Threshold Voltage for PWRGD2 and /PWRGD2		<b>0.5</b>	0.63	<b>0.8</b>	V
$V_{THRESH(PG3)}$	PGTIMER Threshold Voltage for PWRGD3 and /PWRGD3		<b>1.00</b>	1.15	<b>1.30</b>	V
$R_{PGTIMER}$	PGTIMER Discharge Resistance	Voltage on PGTIMER = 0.5 V	<b>250</b>	500	<b>750</b>	$\Omega$
$V_{OVH}$	OV Pin High Threshold Voltage (MIC2589 and MIC2589R)	Low-to-High transition	<b>1.198</b>	1.223	<b>1.247</b>	V
$V_{OVL}$	OV Pin Low threshold Voltage (MIC2589 and MIC2589R)	High-to-Low transition	<b>1.165</b>	1.203	<b>1.232</b>	V
$V_{OVHYS}$	OV Pin Hysteresis (MIC2589 and MIC2589R)			20		mV
$V_{UVL}$	UV Pin Low threshold Voltage (MIC2589 and MIC2589R)	High-to-Low transition	<b>1.198</b>	1.223	<b>1.247</b>	V
$V_{UVH}$	UV Pin High Threshold Voltage (MIC2589 and MIC2589R)	Low-to-High transition	<b>1.213</b>	1.243	<b>1.272</b>	V
$V_{UVHYS}$	UV Pin Hysteresis (MIC2589 and MIC2589R)			20		mV
$V_{ONH}$	ON Pin High Threshold Voltage (MIC2595 and MIC2595R)	Low-to-High transition	<b>1.198</b>	1.223	<b>1.247</b>	V
$V_{OFFL}$	OFF Pin Low Threshold Voltage (MIC2595 and MIC2595R)	High-to-Low transition	<b>1.198</b>	1.223	<b>1.247</b>	V
$I_{CNTRL}$	Input Current (OV, UV, ON, OFF Pins)	$V_{INPUT} = 1.25V$			<b>0.5</b>	$\mu A$
$V_{PGTH}$	Power-Good Threshold ( $V_{DRAIN} - V_{EE}$ )	High-to-Low Transition	<b>1.1</b>	1.26	<b>1.40</b>	V
$V_{OLPG}$	PWRGD Output Voltage (relative to voltage at the DRAIN pin) $V_{OLPG} - V_{DRAIN}$	$0 \leq I_{PG} \leq 1mA$ MIC25XX-1 ( $V_{DRAIN} - V_{EE}$ ) > $V_{PGTH}$	<b>-0.25</b>		<b>0.8</b>	V
		MIC25XX-2 ( $V_{DRAIN} - V_{EE}$ ) < $V_{PGTH}$	<b>-0.25</b>		<b>0.8</b>	V
$I_{LKG(PG)}$	PWRGD Output Leakage Current	$V_{PWRGD} = V_{DD} = 80 V$			<b>1</b>	$\mu A$

## Note:

6. Specification for packaged product only.

**AC Electrical Characteristics<sup>(7)</sup>**

Symbol	Parameter	Condition	Min	Typ	Max	Units
t <sub>OCSENSE</sub>	Overcurrent Sense to GATE Low Trip Time <sup>(8)</sup> Figure 2	V <sub>SENSE</sub> – V <sub>EE</sub> = 100mV			3.5	μs
t <sub>OVPHL</sub>	OV High to GATE Low <sup>(8)</sup> (MIC2589 and MIC2589R) Figure 3	OV = 1.5V		1		μs
t <sub>OVPLH</sub>	OV Low to GATE High <sup>(8)</sup> , (MIC2589 and MIC2589R) Figure 3	OV = 1.0V		1		μs
t <sub>UVPHL</sub>	UV Low to GATE Low <sup>(8)</sup> , (MIC2589 and MIC2589R) Figure 4	UV = 1.0V		1		μs
t <sub>UVPLH</sub>	UV High to GATE High <sup>(8)</sup> (MIC2589 and MIC2589R) Figure 4	UV = 1.5V		1		μs
t <sub>OFFPHL</sub>	OFF Low to GATE Low <sup>(8)</sup> , Figure 5 (MIC2595 and MIC2595R)	OFF = 1.0V		1		μs
t <sub>ONPLH</sub>	ON High to GATE High <sup>(8)</sup> (MIC2595 and MIC2595R) Figure 5	ON = 1.5V		1		μs
t <sub>PGLH1</sub>	DRAIN Low to PWRGD1 Output High <sup>(8)</sup> (MIC25XX-1XX)	C <sub>LOAD</sub> on PWRGDx = 50pF R <sub>PULLUP</sub> = 100kΩ		3		μs
t <sub>PGHL1</sub>	DRAIN High to all PWRGDx Outputs Low <sup>(8)</sup> (MIC25XX-1XX)	C <sub>LOAD</sub> on PWRGDx = 50pF R <sub>PULLUP</sub> = 100kΩ		5		μs
t <sub>PGHL2</sub>	DRAIN Low to /PWRGD1 Output Low <sup>(8)</sup> (MIC25XX-2)	C <sub>LOAD</sub> on /PWRGDx = 50pF R <sub>PULLUP</sub> = 100kΩ		5		μs
t <sub>PGLH2</sub>	DRAIN High to all /PWRGDx Outputs High <sup>(8)</sup> (MIC25XX-2)	C <sub>LOAD</sub> on /PWRGDx = 50pF R <sub>PULLUP</sub> = 100kΩ		3		μs

Note:

7. Specification for packaged product only.

8. Not 100% production tested. Parameters are guaranteed by design.



## Timing Diagrams

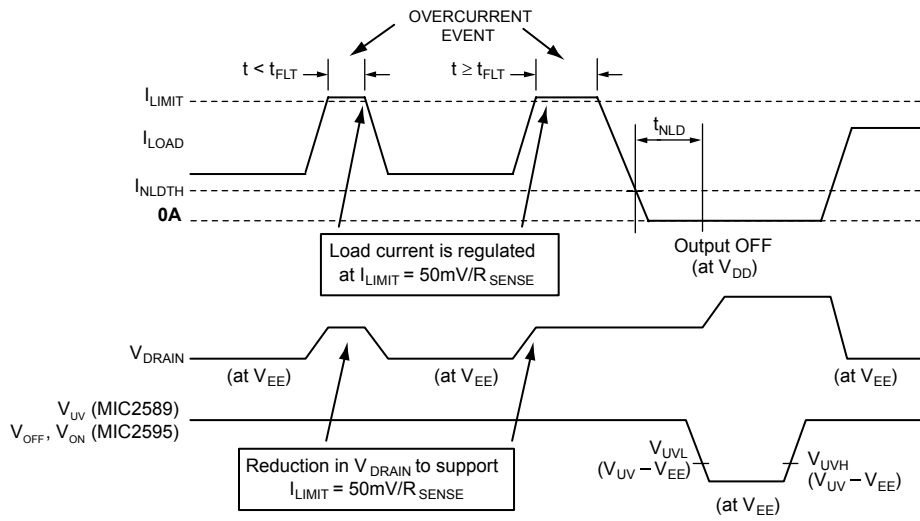

Figure 1. Overcurrent and Undercurrent (No Load) Response

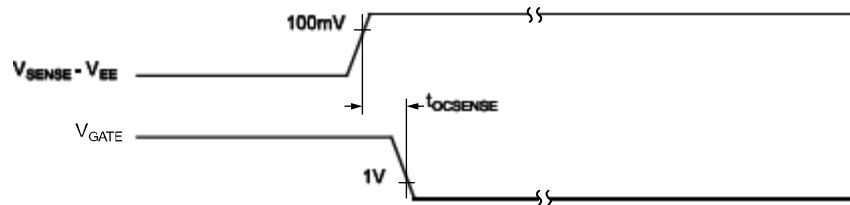

Figure 2. SENSE to GATE Timing Response

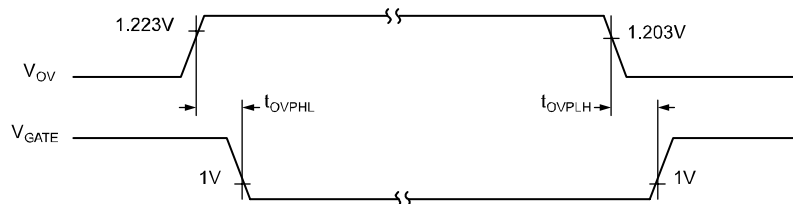

Figure 3. MIC2589/MIC2595 Overvoltage Response

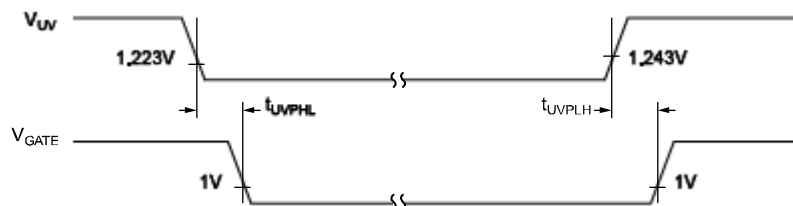

Figure 4. MIC2589/MIC2589R Undervoltage Response

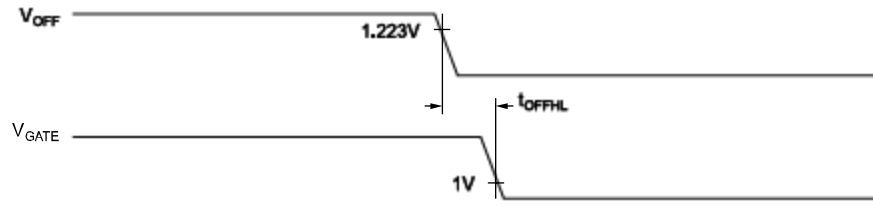

Figure 5a. MIC2595/MIC2595R OFF to GATE Drive Response

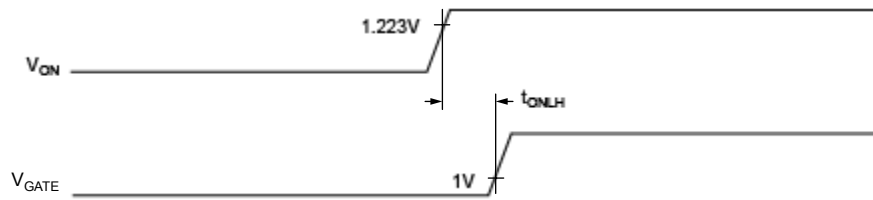

Figure 5b. MIC2595/MIC2595R ON to GATE Drive Response

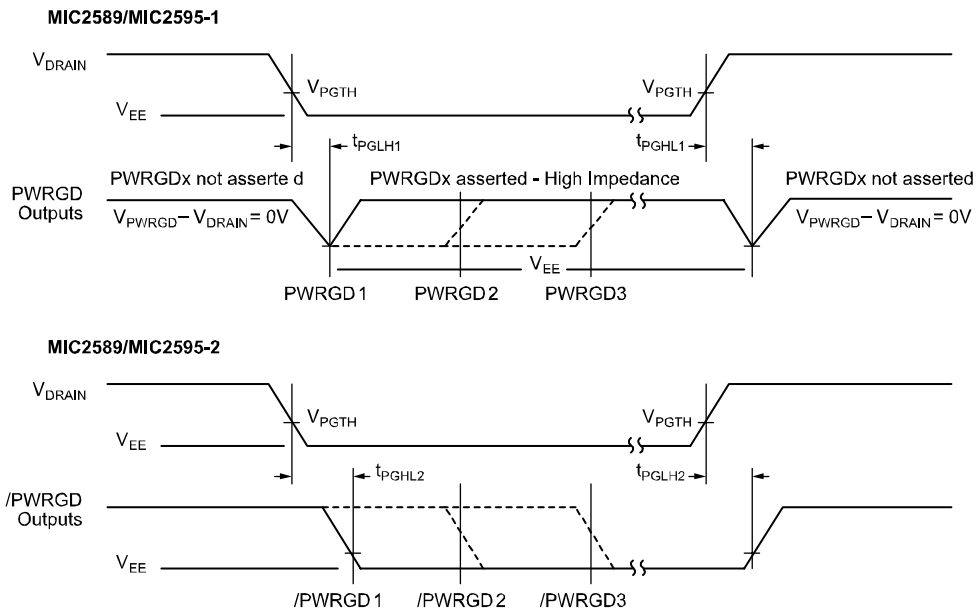
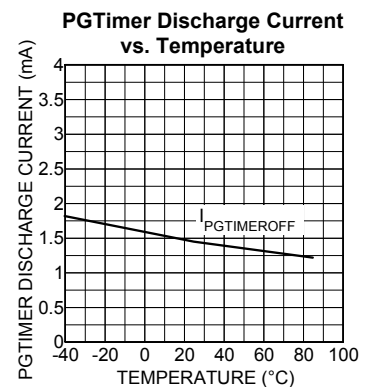
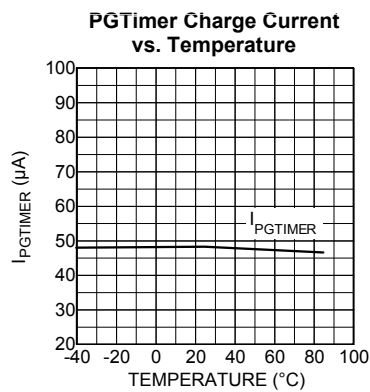
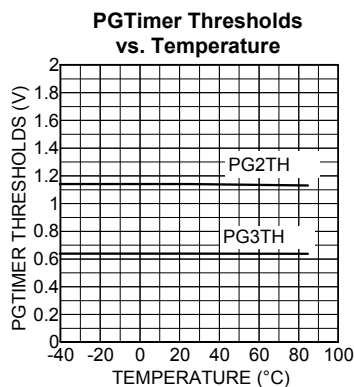
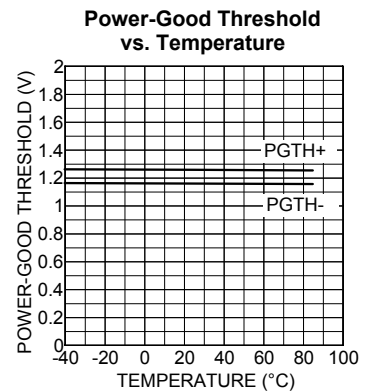
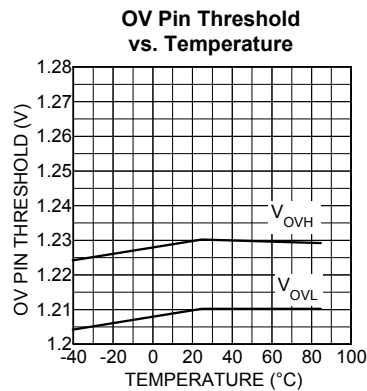
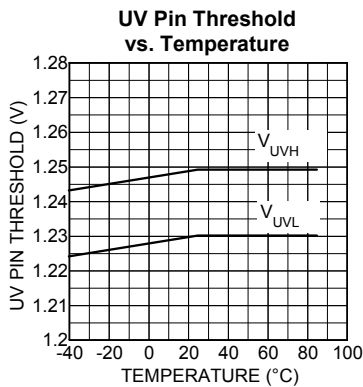
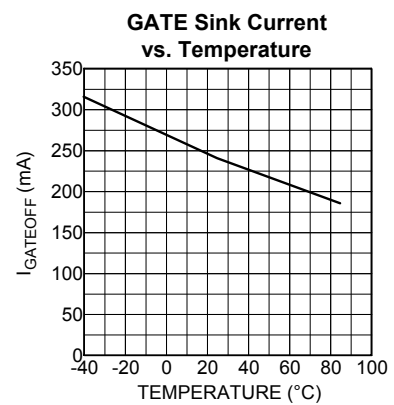
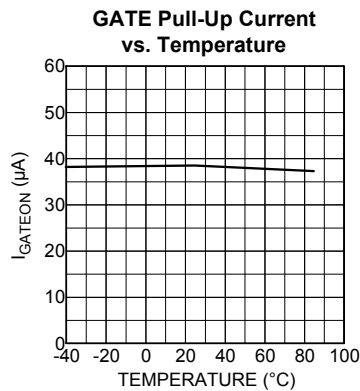
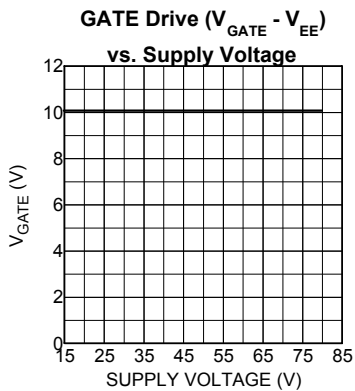
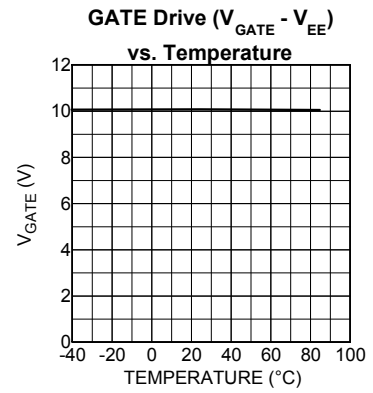
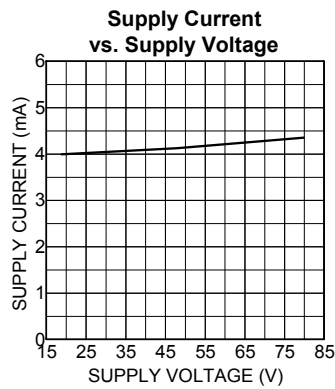
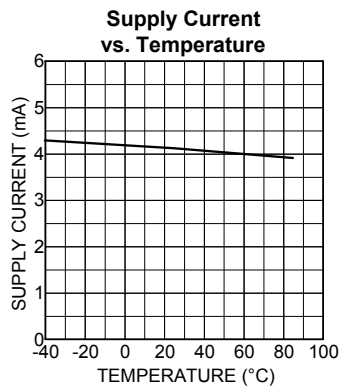
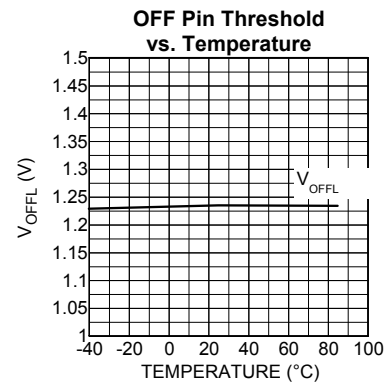
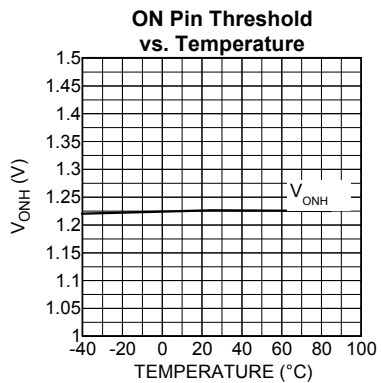
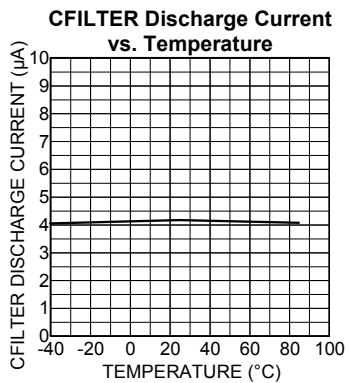
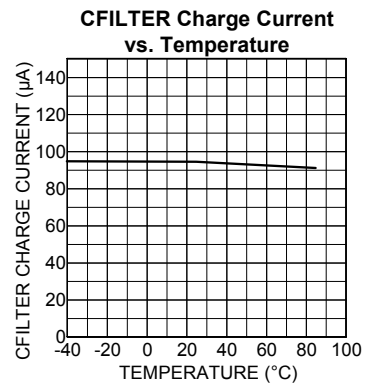
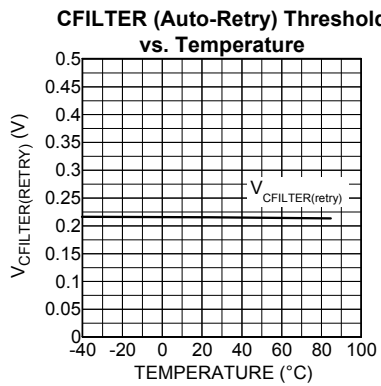
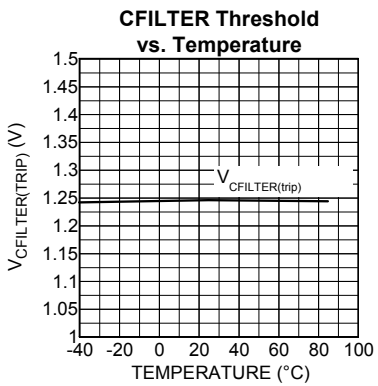
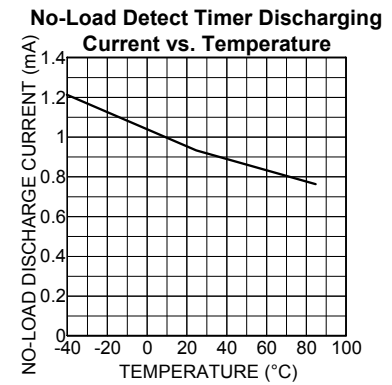
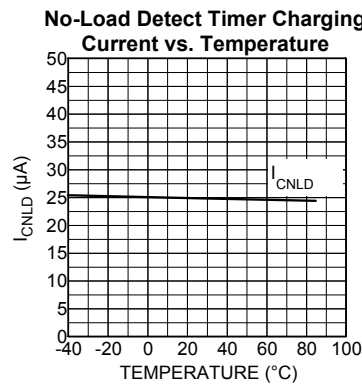
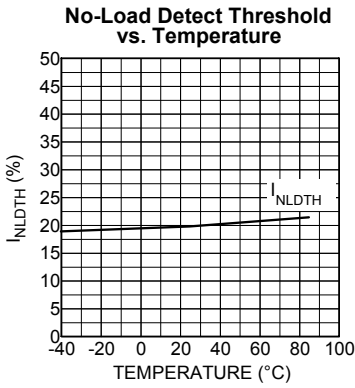
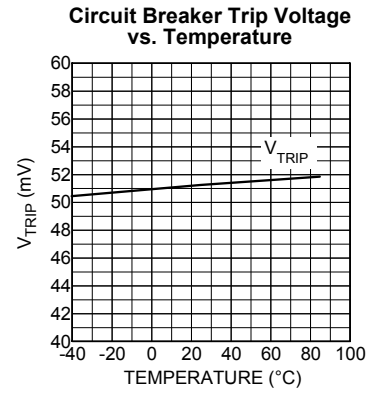
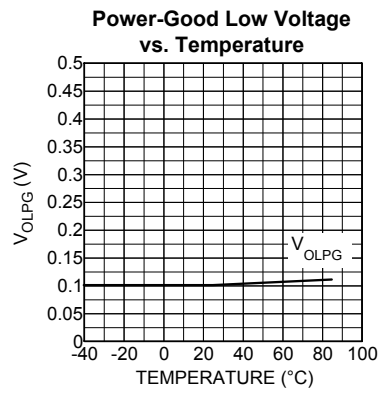
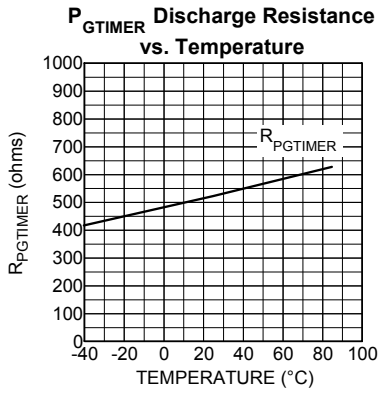

Figure 6. DRAIN to Power-Good Response

# Typical Characteristics



Typical Characteristics (cont.)



### Test Circuit

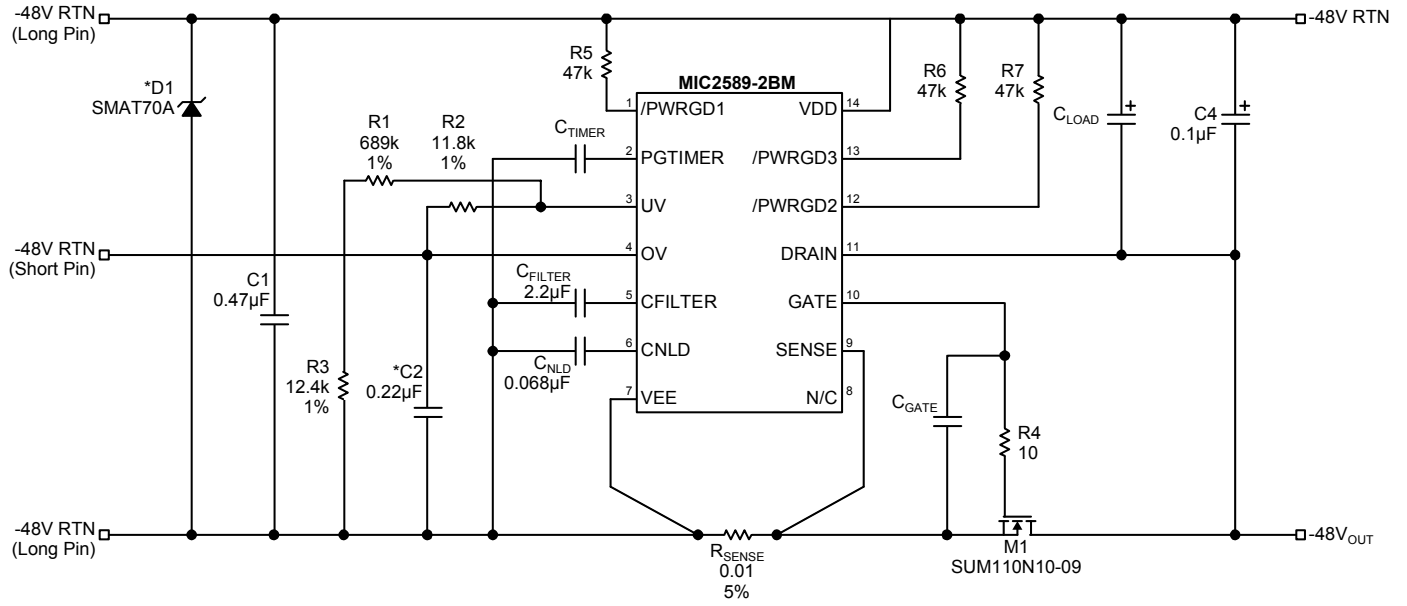

Test Circuit

# Functional Characteristics

**Turn-On Response**

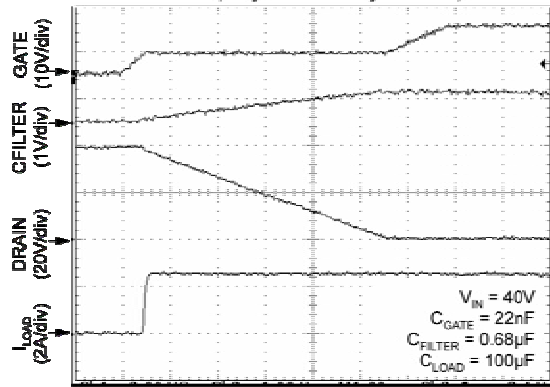

TIME (2.5ms/div.)

**Hot Plug Turn-On Response**

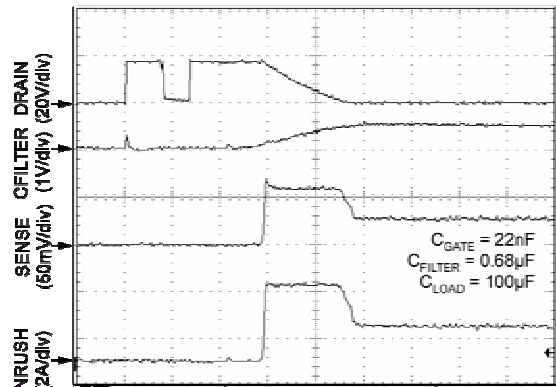

TIME (1ms/div.)

**Inrush Current Into Large  $C_{LOAD}$**

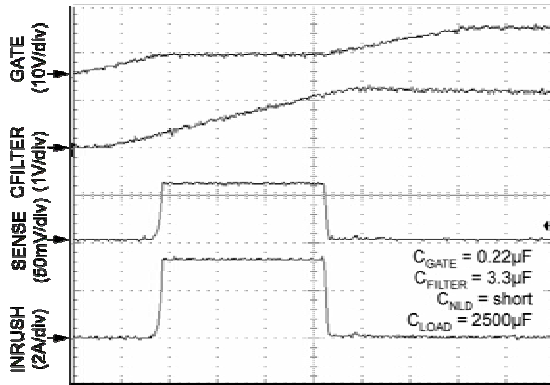

TIME (10ms/div.)

**Power-Good Signals at Turn-On**

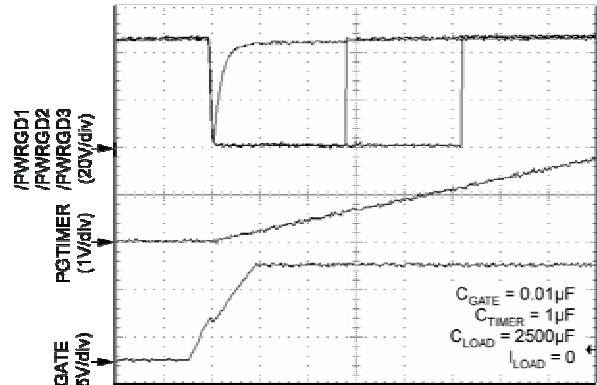

TIME (5ms/div.)

**Auto-Retry Response**

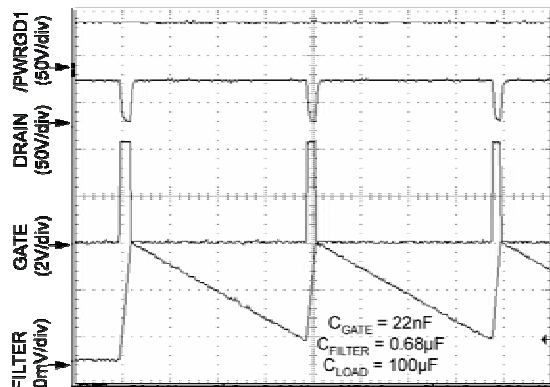

TIME (50ms/div.)

**UVLO Glitch Response**

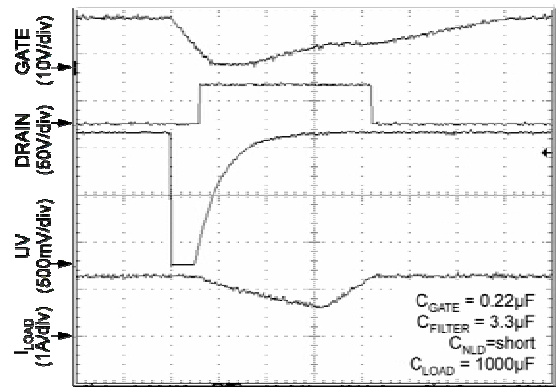

TIME (10ms/div.)

# Functional Diagram

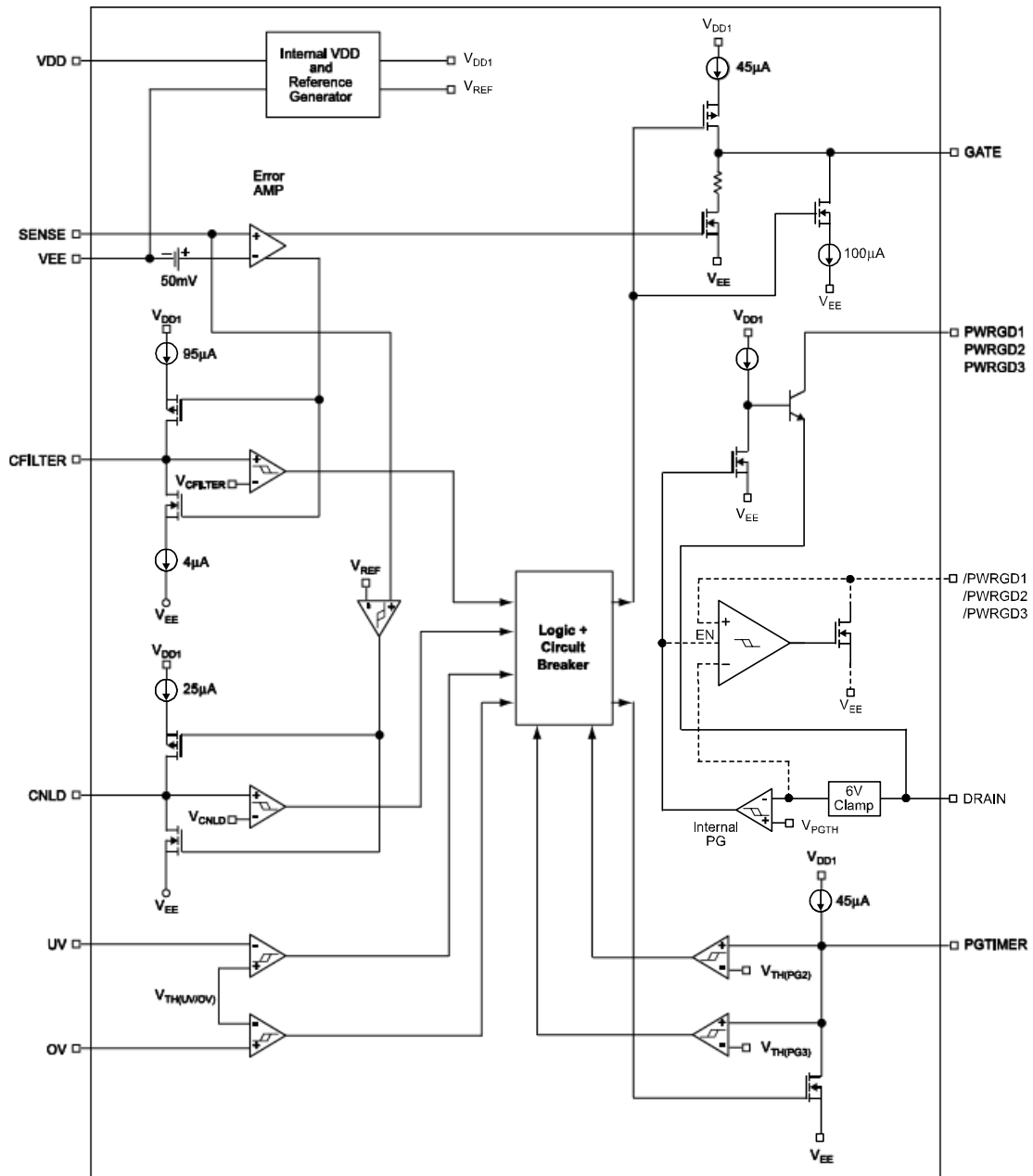

----- denotes -2 option  
(Applies to Power-Good circuitry)

Block Diagram

## Functional Description

### Hot Swap Insertion

When circuit boards are inserted into systems carrying live supply voltages (“hot swapped”), high inrush currents often result due to the charging of bulk capacitance that resides across the circuit board’s supply pins. These current spikes can cause the system’s supply voltages to temporarily go out of regulation causing data loss or system lock-up. In more extreme cases, the transients occurring during a hot swap event may cause permanent damage to connectors or onboard components.

The MIC2589 and the MIC2595 are designed to address these issues by limiting the maximum current that is allowed to flow during hot swap events. This is achieved by implementing a constant-current loop at turn-on. In addition to inrush current control, the MIC2589 and the MIC2595 incorporate input voltage supervisory functions and user programmable overcurrent protection, thereby providing robust protection for both the system and the circuit board.

### GATE Start-Up and Control

When the input voltage to the controller is between the overvoltage and undervoltage threshold settings (MIC2589) or is greater than the ON threshold setting (MIC2595), a start cycle is initiated to deliver power to the load. During the start-up cycle, the GATE pin of the controller applies a constant charging current (45 $\mu$ A, nominal) to the gate of the external MOSFET, charging the MOSFET gate from 0V to 10V, referenced to  $V_{EE}$ . An external capacitor (C2) can be used to adjust and control the slew rate of the GATE output, while resistor R4 can be used to minimize the potential for parasitic high-frequency oscillations occurring on the gate of the external MOSFET (M1). See Typical Application circuit. The following equation is used to approximate the expected inrush current given the values of the capacitance at the gate and the load (i.e., the gate of the external MOSFET and the drain of the external MOSFET, respectively).

$$I_{NRUSH} = \frac{C_{LOAD}}{C_{GATE}} \times I_{GATE(ON)}$$

Active current limiting for the MIC2589/MIC2595 is implemented by controlling the voltage on the GATE pin via an internal feedback circuit. The MIC2589/MIC2595 is defined to be in current limit when the GATE output voltage level is between 2.5V and 5.5V. Once in current limit, the GATE output voltage is regulated to limit the load current to the programmed value ( $I_{LIMIT}$ ). Additionally, the

overcurrent delay and the no-load detection timers must be set accordingly to allow the output load to fully charge during the start-up cycle. See the “Circuit Breaker Function” and “No-Load Detection” sections for further details.

Resistor R4, in series with the power MOSFET’s gate, may be required in some layouts to minimize the potential for parasitic oscillations occurring in M1. Note that resistance in this device of the circuit has a slight destabilizing effect upon the MIC2589/MIC2595’s current regulation loop. If possible, use high-frequency PCB layout techniques and use a dummy resistor ( $R4 = 0\Omega$ ) for the initial evaluation. If during prototyping an R4 is required, common values for R4 range between 4.7 $\Omega$  to 20 $\Omega$  for various power MOSFETs.

### Circuit Breaker Function

The MIC2589 and MIC2595 device family employs an electronic circuit breaker that protects the external power MOSFET and other system components against large-scale faults, such as short circuits. The current-limit threshold is set via an external resistor,  $R_{SENSE}$ , connected between the VEE and SENSE pins.

$$I_{LIMIT} = \frac{V_{TRIP}}{R_{SENSE}}$$

An overcurrent filter period is set via a capacitor from the CFILTER pin to ground ( $C_{FILTER}$ ) that determines the length of the time period ( $t_{FLT}$ ) for which the device remains in current limit before the circuit breaker is tripped. This programmable delay prevents tripping of the circuit breaker due to the large inrush current charging bulk and distributed capacitive loads.

Whenever the voltage across  $R_{SENSE}$  exceeds 50mV, two things happen:

1. A constant-current regulation loop is engaged which is designed to hold the voltage across  $R_{SENSE}$  equal to 50mV. This protects both the load and the MIC2589/MIC2595 circuits from excessively high currents. This current-regulation loop will engage in less than 1 $\mu$ s from the time at which the overcurrent trip threshold on  $R_{SENSE}$  is exceeded.
2. Capacitor  $C_{FILTER}$  is charged up to an internal  $V_{CFILTER(TRIP)}$  threshold of 1.25V by  $I_{CFILTER(CHARGE)}$  an internal 95 $\mu$ A current source. If the voltage across CFILTER crosses this threshold, the circuit breaker trips and the GATE pin is immediately pulled low by an internal current pull-down. This operation turns off the MOSFET quickly and disconnects the input from the load. The time period that allows for the output to regulate in



current limit is defined as the overcurrent fault timer,  $t_{FLT}$ , and is determined by the following equation.

$$t_{FLT} = \frac{C_{FILTER} \times V_{CFILTER(trip)}}{I_{CFILTER(CHARGE)}}$$

The value of  $C_{FILTER}$  should be selected to allow the circuit's minimum regulated value of  $I_{OUT}$  to equal  $I_{LIMIT}$  for somewhat longer than the time it takes to charge the total load capacitance.

During startup, the  $C_{FILTER}$  pin will begin to charge once the GATE crosses 2.5V. In order to avoid false-tripping of the circuit breaker by allowing the overcurrent filter to time out, the overcurrent delay must be set to exceed the time it takes to ramp the GATE output above 5.5V (i.e., charge the output load capacitance).

An initial value for  $C_{FILTER}$  is found by calculating the time it will take for the MIC2589/MIC2595 to completely charge up the output capacitive load. Assuming the load is enabled by the PWRGDX (or /PWRGDX) signal(s) of the controller, the turn-on delay time is derived from  $I = C \times (dv/dt)$ :

$$t_{TURN-ON} = \frac{C_{LOAD} \times (V_{DD} - V_{EE})}{I_{LIMIT}}$$

Using parametric values specific to the MIC2589/MIC2595, an expression relating  $C_{FILTER}$  to the circuit's turn-on delay time is:

$$C_{FILTER} = \frac{(t_{TURN-ON} \times I_{CFILTER})}{V_{CFILTER}}$$

Substituting the variables above with the specification limits of the MIC2589/MIC2595, an expression for the worst-case value for  $C_{FILTER}$  is given by:

$$C_{FILTER(max)} = t_{TURN-ON} \times \left( \frac{135\mu A}{1.17V} \right)$$

$$C_{FILTER(max)} = t_{TURN-ON} \times \left( 115 \times 10^{-6} \frac{\mu F}{sec} \right)$$

For example, in a system with a  $C_{LOAD} = 1500\mu F$ , a maximum  $(V_{DD} - V_{EE}) = 72V$ , and a maximum load current on a nominal -48V buss of 2.5A, the nominal circuit design equations steps are:

1. Choose  $I_{LIMIT} = I_{HOT\_SWAP(nom)} = 3A$  (2.5A + 20%);
2. Select an  $R_{SENSE} = \frac{38.8mV}{3A} = 12.9m\Omega$  (closest 1% standard value is 13.0m $\Omega$ );
3. Using  $I_{CHARGE} = I_{LIMIT} = 3A$ , the application circuit turn-on time is calculated:

$$t_{TURN-ON} = \frac{(1500\mu F \times 72V)}{3A} = 36ms \text{ (use 40ms)}$$

Allowing for capacitor tolerances and a nominal 40ms turn-on time, an initial worst-case value for  $C_{FILTER}$  is:

$$C_{FILTER(WORST-CASE)} = 40ms \times (115 \times 10^{-6} \mu F/sec) = 4.6\mu F$$

The closest standard  $\pm 10\%$  tolerance capacitor value is 4.7 $\mu F$  and would be a good initial starting value for prototyping.

Whenever the hot swap controller is not in current limit,  $C_{FILTER}$  is discharged to VEE by an internal 4 $\mu A$  current source.

For the MIC2589R/MIC2595R devices, the circuit breaker automatically resets after approximately 25  $t_{FLT}$  time constants ( $23.75 \times t_{FLT\_AUTO}$ ). If the fault condition still exists, capacitor  $C_{FILTER}$  will again charge up to  $V_{CFILTER(TRIP)}$ , tripping the circuit breaker. Capacitor  $C_{FILTER}$  will then be discharged by an internal 4 $\mu A$  current source until the voltage across  $C_{FILTER}$  goes below  $V_{CFILTER(RETRY)}$ , at which time another start cycle is initiated. This will continue until the fault condition is removed or input power is removed/cycled. The duty cycle of the auto-restart function is therefore fixed at 4.25% and the period of the auto-restart cycle is given by:

$$t_{RETRY} = t_{FLT} + t_{FLT\_AUTO}$$

$$t_{RETRY} = t_{FLT} + \frac{[C_{FILTER} \times (V_{CFILTER(TRIP)} - V_{CFILTER(retry)})]}{I_{CFILTER(pull-down)}}$$

The auto-restart period for the example above where the worst-case  $C_{FILTER}$  was determined to be 4.7 $\mu F$  is:

$$t_{AUTO-RESTART} = 1.27s$$

### No-Load Detection

For applications in which a minimum load current will always be present, the no-load detect capability of the MIC2589 product family offers system designers the ability to perform a shutdown operation on such fault conditions, such as an unscheduled or unexpected removal of PC boards from the system or on-board fuse failure. As long as the minimum current drawn by the load is at least 20% of the current limit (defined by

$\frac{V_{TRIP}}{R_{SENSE}}$ ), the output of the hot swap controller will

remain enabled. If the output current falls below 20% of the actual current limit, the controller's no-load detection loop is enabled. In this loop, an internal current source,  $I_{CNLD}$ , will charge an external capacitor  $C_{NLD}$ . An expression for the controller's no-load time-out delay is given by:

$$t_{\text{NLD}} = V_{\text{CNLD}} \times \left( \frac{C_{\text{NLD}}}{I_{\text{CNLD}}} \right)$$

where  $V_{\text{CNLD}} = 1.24\text{V}$  (typ);  $I_{\text{CNLD}} = 25\mu\text{A}$  (typ); and  $C_{\text{NLD}}$  is an external capacitor connected from Pin 6 to VEE. Once the voltage on CNLD reaches its no-load threshold voltage,  $V_{\text{CNLD}}$ , the loop times out and the controller will shut down until it is reset manually (MIC2589/MIC2595) or until it performs an auto-retry operation (MIC2589R/MIC2595R). During start-up, the no-load detection circuit begins to monitor the load current and the CNLD pin starts ramping along with the GATE output. In order to keep the output from shutting down,  $t_{\text{NLD}}$  must be long enough to ensure that the output MOSFET switches on to deliver the required minimum load-detect current to the output load before the no-load timer times out.

### The Power-Good Output Signals

For the MIC2589/MIC2595-1 and MIC2589R/MIC2595R-1, power-good output signal PWRGD1 will be high impedance when  $V_{\text{DRAIN}}$  drops below  $V_{\text{PGTH}}$ , and will pull-down to the potential at the DRAIN when  $V_{\text{DRAIN}}$  is above  $V_{\text{PGTH}}$ . For the MIC2589/95-2 and the MIC2589R/95R-2, power-good output signal /PWRGD1 will pull down to the potential of the DRAIN pin when  $V_{\text{DRAIN}}$  drops below  $V_{\text{PGTH}}$  and will be high impedance when  $V_{\text{DRAIN}}$  is above  $V_{\text{PGTH}}$ . Hence, the -1 parts have an active-high PWRGD1 signal and the -2 parts have an active-low /PWRGD1 output. PWRGD1 (or /PWRGD1) may be used as an enable signal for one or more following DC/DC converter modules or for other system uses as desired. When used as an enable signal, the time necessary for the PWRGD1 (or /PWRGD1) signal to pull-up (when in high impedance state) will depend upon the load (RC) that is present on this output.

Power-good output signals PWRGD2 (/PWRGD2) and PWRGD3 (/PWRGD3) follow the assertion of PWRGD1 (/PWRGD1) with a sequencing delay set by an external capacitor ( $C_{\text{PG}}$ ) from the controller's PGTIMER pin (Pin 2) to VEE. An expression for the sequencing delay between PWRGD2 and PWRGD1 is given by:

$$t_{\text{PGDLY2-1}} = \frac{V_{\text{THRESH(PG2)}} \times C_{\text{PG}}}{I_{\text{PGTIMER}}}$$

where  $V_{\text{THRESH(PG2)}} (= 0.63\text{V}$ , typically) is the PWRGD2 threshold voltage for PGTIMER and  $I_{\text{PGTIMER}} (= 45\mu\text{A}$ , typically) is the internal PGTIMER charge current. Similarly, an expression for the sequencing delay between PWRGD3 and PWRGD2 is given by:

$$t_{\text{PGDLY3-2}} = \frac{(V_{\text{THRESH(PG3)}} - V_{\text{THRESH(PG2)}}) \times C_{\text{PG}}}{I_{\text{PGTIMER}}}$$

where  $V_{\text{THRESH(PG3)}}$  (1.15V, typical) is the PWRGD3 threshold voltage for PGTIMER. Therefore, power-good output signal PWRGD2 (/PWRGD2) will be delayed after the assertion of PWRGD1 (/PWRGD1) by:

$$t_{\text{PGDLY2-1}} (\text{ms}) \cong 14 \times C_{\text{PG}} (\mu\text{F})$$

Power-good output signal PWRGD3 (/PWRGD3) follows the assertion of PWRGD2 by a delay:

$$t_{\text{PGDLY3-2}} (\text{ms}) \cong 11.5 \times C_{\text{PG}} (\mu\text{F})$$

For example, for a  $10\mu\text{F}$  value for  $C_{\text{PG}}$ , power-good output signal PWRGD2 will be asserted 140ms after PWRGD1. Power-good signal PWRGD3 will then be asserted 115ms after PWRGD2 and 255ms after the assertion of PWRGD1. The relationships between  $V_{\text{DRAIN}}$ ,  $V_{\text{PGTH}}$ , PWRGD1, PWRGD2, and PWRGD3 are shown in Figure 6.

### Undervoltage/Overvoltage Detection (MIC2589 and MIC2589R)

The MIC2589 and the MIC2589R have "UV" and "OV" input pins that can be used to detect input supply rail undervoltage and overvoltage conditions. Undervoltage lockout prevents the output from switching on until the supply input is stable and within tolerance. In a similar fashion, overvoltage shutdown prevents damage to sensitive circuit components should the input voltage exceed normal operating limits. Each of these pins is internally connected to analog comparators with 20mV of hysteresis. When the UV pin falls below its  $V_{\text{UVL}}$  threshold or the OV pin is above its  $V_{\text{OVH}}$  threshold, the GATE pin is immediately pulled low. The GATE pin will be held low until the UV pin is above its  $V_{\text{UVH}}$  threshold and the OV pin is below its  $V_{\text{OVL}}$  threshold. The circuit's UV and OV threshold voltage levels are programmed using the resistor divider R1, R2, and R3 as shown in the "Typical Application" circuit and the equations to set the trip points are shown below. The circuit's UV threshold is set to  $V_{\text{UV}} = 37\text{V}$  and the OV threshold is set at  $V_{\text{OV}} = 72\text{V}$ , values commonly used in Central Office power distribution applications.

$$V_{\text{UV}} = V_{\text{UVL}} (\text{typ}) \times \frac{(R1 + R2 + R3)}{(R2 + R3)}$$

$$V_{\text{OV}} = V_{\text{OVL}} (\text{typ}) \times \frac{(R1 + R2 + R3)}{R3}$$

Given  $V_{\text{UV}}$ ,  $V_{\text{OV}}$ , and any one of the resistor values, the remaining two resistor values can be determined. A suggested value for R3 is selected to provide approximately  $100\mu\text{A}$  (or more) of current through the voltage divider chain at  $V_{\text{DD}} = V_{\text{UV}}$ . This yields the

following as a starting point:

$$R3 = \frac{V_{OVH}(\text{typ})}{100\mu\text{A}} = \frac{1.223\text{V}}{100\mu\text{A}} = 12.23\text{k}\Omega$$

The closest standard 1% value for  $R3 = 12.4\text{k}\Omega$ . Solving for  $R2$  and  $R1$  yields:

$$R2 = R3 \times \left[ \left( \frac{V_{OV}}{V_{UV}} \right) - 1 \right]$$

$$R2 = 12.4\text{k}\Omega \times \left[ \left( \frac{72\text{V}}{37\text{V}} \right) - 1 \right] = 11.73\text{k}\Omega$$

The closest standard 1% values for  $R2 = 11.8\text{k}\Omega$ . Lastly, the value for  $R1$  is calculated:

$$R1 = R3 \times \left[ \frac{(V_{OV} - 1.223\text{V})}{1.223\text{V}} \right] - R2$$

$$R1 = 12.4\text{k}\Omega \times \left[ \frac{(72\text{V} - 1.223\text{V})}{1.223\text{V}} \right] - 11.8\text{k}\Omega$$

$$R1 = 705.81\text{k}\Omega$$

The closest standard 1% value for  $R1 = 698\text{k}\Omega$ .

Using standard 1% resistor values, the circuit's nominal UV and OV thresholds are:

$$V_{UV} = 36.5\text{V}$$

$$V_{OV} = 71.2\text{V}$$

Good general engineering design practices must consider the tolerances associated with these parameters, including but not limited to, power supply tolerance, undervoltage and overvoltage threshold tolerances, and the tolerances of the external passive components.

### Programmable UVLO Hysteresis (MIC2595 and MIC2595R)

The MIC2595 and the MIC2595R devices have user-programmable hysteresis by means of the ON and OFF pins (Pins 4 and 3, respectively). This allows setting the MIC2595/MIC2595R to turn on at a voltage  $V1$ , and not turn off until a second voltage  $V2$ , where  $V2 < V1$ . This can significantly simplify dealing with source impedances in the supply buss while at the same time increasing the amount of available operating time from a loosely regulated power rail (for example, a battery supply). The MIC2595/MIC2595R holds the output off until the voltage at the ON pin is above its  $V_{ONH}$  threshold value given in the "Electrical Characteristics" table. Once the output has been enabled by the ON pin, it will remain on until the voltage at the OFF pin falls below its respective  $V_{OFFL}$  threshold value, or the part turns off due to an external

fault condition. Should either event occur, the GATE pin is immediately pulled low and will remain low until the ON pin voltage once again rises above its  $V_{ONH}$  threshold. The circuit's turn-on and turn-off voltage levels are set using the resistor divider  $R1$ ,  $R2$ , and  $R3$  similar to the "Typical Application" circuit and the equations to set the trip points are shown below. For the following example, the circuit's ON threshold is set to  $V_{ON} = 40\text{V}$  and the circuit's OFF threshold is set to  $V_{OFF} = 35\text{V}$ .

$$V_{ON} = V_{ONH}(\text{typ}) \times \frac{(R1 + R2 + R3)}{R3}$$

$$V_{OFF} = V_{OFFL}(\text{typ}) \times \frac{(R1 + R2 + R3)}{R2 + R3}$$

Given  $V_{OFF}$ ,  $V_{ON}$ , and any one of the resistor values, the remaining two resistor values can be readily determined. A suggested value for  $R3$  is selected to provide approximately  $100\mu\text{A}$  (or more) of current through the voltage divider chain at  $V_{DD} = V_{OFF}$ . This yields the following as a starting point:

$$R3 = \frac{V_{OFFL}(\text{typ})}{100\mu\text{A}} = \frac{1.223\text{V}}{100\mu\text{A}} = 12.23\text{k}\Omega$$

The closest standard 1% value for  $R3 = 12.4\text{k}\Omega$ . Solving for  $R2$  and  $R1$  yields:

$$R2 = R3 \times \left[ \left( \frac{V_{ON}}{V_{OFF}} \right) - 1 \right]$$

$$R2 = 12.4\text{k}\Omega \times \left[ \left( \frac{40\text{V}}{35\text{V}} \right) - 1 \right] = 1.77\text{k}\Omega$$

The closest standard 1% value for  $R2 = 1.78\text{k}\Omega$ . Lastly, the value for  $R1$  is calculated:

$$R1 = R3 \times \frac{(V_{ON} - 1.223\text{V})}{1.223\text{V}} - R2$$

$$R1 = 12.4\text{k}\Omega \times \frac{40\text{V} - 1.223\text{V}}{1.223\text{V}} - 1.78\text{k}\Omega$$

$$R1 = 391.38\text{k}\Omega$$

The closest standard 1% value for  $R1 = 392\text{k}\Omega$ .

Using standard 1% resistor values, the circuit's nominal ON and OFF thresholds are:

$$V_{ON} = 40.1\text{V}$$

$$V_{OFF} = 35\text{V}$$

Good general engineering design practices must consider the tolerances associated with these parameters, including but not limited to, power supply tolerance, undervoltage and overvoltage threshold tolerances, and the tolerances of the external passive components.

## Application Information

### Optional External Circuits for Added Protection/Performance

In many telecom applications, it is very common for circuit boards to encounter large-scale supply-voltage transients in backplane environments. Because backplanes present a complex impedance environment, these transients can be as high as 2.5 times steady-state levels, or 120V in worst-case situations. In addition, a sudden load dump anywhere on the circuit card can generate a very high voltage spike at the drain of the output MOSFET that will appear at the DRAIN pin of the MIC2589/MIC2595. In both cases, it is good engineering practice to include protective measures to avoid damaging sensitive ICs or the hot swap controller from these large-scale transients. Two typical scenarios in which large-scale transients occur are described below:

1. An output current load dump with no bypass (charge bucket or bulk) capacitance to  $V_{EE}$ . For example, if  $L_{LOAD} = 5\mu H$ ,  $V_{IN} = 56V$  and  $t_{OFF} = 0.7\mu s$ , the resulting peak short-circuit current prior to the MOSFET turning off would reach:

$$\frac{(56V \times 0.7\mu s)}{5\mu H} = 7.8A$$

If there is no other path for this current to take when the MOSFET turns off, it will avalanche the drain-source junction of the MOSFET. Since the total energy represented is small relative to the sturdiness of modern power MOSFETs, it's unlikely that this will damage the transistor. However, the actual avalanche voltage is unknown; all that can be guaranteed is that it will be greater than the  $V_{BD(D-S)}$  of the MOSFET. The drain of the transistor is connected to the DRAIN pin of

the MIC2589/MIC2595, and the resulting transient does have enough voltage and energy to damage this, or any, high-voltage hot swap controller.

2. If the load's bypass capacitance (for example, the input filter capacitors for DC-DC converter module(s)) is on a board from which the board with the MIC2589/MIC2595 and the MOSFET can be unplugged, the same type of inductive transient damage can occur to the MIC2589/MIC2595.

For many applications, the use of additional circuit components can be implemented for optimum system performance and/or protection. The circuit, shown in Figure 7, includes several components to address some of the following system (dynamic) responses and/or functions: 1) suppression of transient voltage spikes, 2) elimination of false "tripping" of the circuit breaker due to undervoltage and overcurrent glitches, and 3) the implementation of an external reset circuit.

It is not mandatory that these techniques be utilized, however, the application environment will dictate suitability. For protection against sudden on-card load dumps at the DRAIN pin of the MIC2589/MIC2595 controller, a 68V, 1W, 5% Zener diode clamp (D2) connected from the DRAIN to the VEE of the controller can be implemented as shown. To protect the controller from large-scale transients at the card input, a 100V clamp diode (D1, SMAT70A or equivalent) can be used. In either case, very short lead lengths and compact layout design is strongly recommended to prevent unwanted transients in the protection circuitry. Power buss inductance often produces localized (plug-in card) high-voltage transients during a turn-off event. Managing these repeated voltage stresses with sufficient input bulk capacitance and/or transient suppressing diode clamps is highly recommended for maximizing the life of the hot swap controller(s).

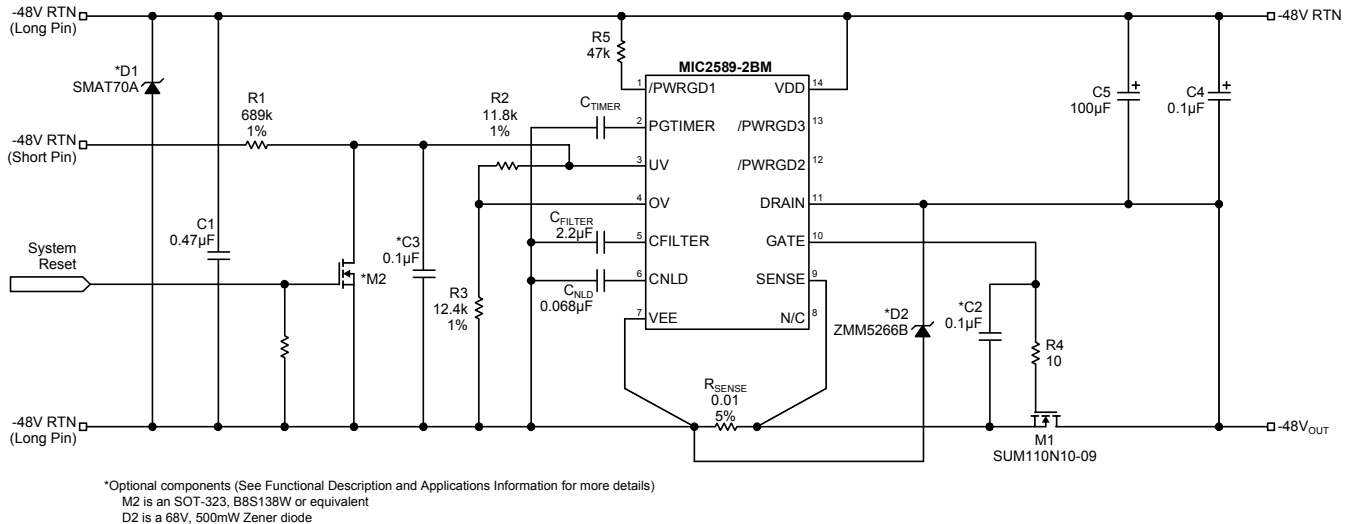

**Figure 7. Optional Components for Added Performance/Protection**

The circuit in Figure 7 consisting of M2, R5, and a digital control signal, can be used to reset the controller after the GATE (and output) turns off. Once the output has been latched off, applying a low-high-low pulse on the GATE of M2 via the System Enable control can toggle the UV pin. System Enable is a user-defined signal referenced to V<sub>EE</sub>.

**Sense Resistor Selection**

The sense resistor is nominally valued at:

$$R_{SENSE(nom)} = \frac{V_{TRIP(typ)}}{I_{HOT\_SWAP(nom)}}$$

where V<sub>TRIP(TYP)</sub> is the typical (or nominal) circuit breaker threshold voltage (50mV) and I<sub>HOT\_SWAP(NOM)</sub> is the nominal load current level necessary to trip the internal circuit breaker.

To accommodate worse-case tolerances in the sense resistor (for a ±1% initial tolerance, allow ±3% tolerance for variations over time and temperature) and circuit breaker threshold voltages, a slightly more detailed calculation must be used to determine the minimum and maximum hot swap load currents.

As the MIC2589's minimum current limit threshold voltage is 40mV, the minimum hot swap load current is determined where the sense resistor is 3% high:

$$I_{HOT\_SWAP(min)} = \frac{40mV}{(1.03 \times R_{SENSE(nom)})} = \frac{38.8mV}{R_{SENSE(nom)}}$$

Keep in mind that the minimum hot swap load current should be greater than the application circuit's upper steady-state load current boundary. Once the lower

value of R<sub>SENSE</sub> has been calculated, it is good practice to check the maximum hot swap load current (I<sub>HOT\_SWAP(MAX)</sub>) that the circuit may let pass in the case of tolerance build-up in the opposite direction. Here, the worse case maximum is found using a V<sub>TRIP(MAX)</sub> threshold of 60mV and a sense resistor 3% low in value:

$$I_{HOT\_SWAP(max)} = \frac{60mV}{(0.97 \times R_{SENSE(nom)})} = \frac{61.9mV}{R_{SENSE(nom)}}$$

In this case, the application circuit must be sturdy enough to operate up to approximately 1.5x the steady-state hot swap load current. For example, if an MIC2589 circuit must pass a minimum hot swap load current of 4A without nuisance trips, R<sub>SENSE</sub> should be set to:

$$R_{SENSE(nom)} = \frac{40mV}{4A} = 10m\Omega$$

where the nearest 1% standard value is 10.0mΩ. At the other tolerance extremes, I<sub>HOT\_SWAP(MAX)</sub> for the circuit in question is then simply:

$$I_{HOT\_SWAP(max)} = \frac{61.9mV}{10m\Omega} = 6.19A$$

With a knowledge of the application circuit's maximum hot swap load current, the power dissipation rating of the sense resistor can be determined using P = I<sup>2</sup> × R. Here, the current is I<sub>HOT\_SWAP(max)</sub> = 6.19A and the resistance

$$R_{SENSE(max)} = (1.03)(R_{SENSE(nom)}) = 10.3m\Omega.$$

Thus, the sense resistor's maximum power dissipation is:

$$P_{MAX} = (6.19A)^2 \times (10.3m\Omega) = 0.395W$$

A 0.5W sense resistor is a good choice in this application.

### Power MOSFET Selection

Selecting the proper external MOSFET for use with the MIC2589/MIC2595 involves three straightforward tasks:

- Choice of a MOSFET that meets minimum voltage requirements.
- Selection of a device to handle the maximum continuous current (steady-state thermal issues).
- Verify the selected part's ability to withstand any peak currents (transient thermal issues).

### Power MOSFET Operating Voltage Requirements

The first voltage requirement for the MOSFET is that the drain-source breakdown voltage of the MOSFET must be greater than  $V_{IN(MAX)} = V_{DD} - V_{EE(min)}$ .

The second breakdown voltage criterion that must be met is the gate-source voltage. For the MIC2589/MIC2595, the gate of the external MOSFET is driven up to a maximum of 11V above VEE. This means that the external MOSFET must be chosen to have a gate-source breakdown voltage of 12V or more; 20V is recommended. Most power MOSFETs with a 20V gate-source voltage rating have a 30V drain-source breakdown rating or higher. For many 48V telecom applications, transient voltage spikes can approach, and sometimes exceed, 100V. The absolute maximum input voltage rating of the MIC2589/MIC2595 is 100V; therefore, a drain-source breakdown voltage of 100V is suggested for the external MOSFET. Additionally, an external input voltage clamp is strongly recommended for applications that do not utilize conditioned power supplies.

### Power MOSFET Steady-State Thermal Issues

The selection of a MOSFET to meet the maximum continuous current is a fairly straightforward exercise. First, arm yourself with the following data:

- The value of  $I_{LOAD(CONT, MAX)}$  for the output in question (see Sense Resistor Selection).
- The manufacturer's datasheet for the candidate MOSFET.
- The maximum ambient temperature in which the device will be required to operate.
- Any knowledge you can get about the heat sinking available to the device (e.g., can heat be dissipated into the ground plane or power plane, if using a surface-mount part? Is any airflow available?).

The datasheet will almost always give a value of ON resistance for a given MOSFET at a gate-source

voltage of 4.5V and 10V. For MIC2589/MIC2595 applications, choose the gate-source ON resistance at 10V and call this value  $R_{ON}$ . Since a heavily enhanced MOSFET acts as an ohmic (resistive) device, almost all that's required to determine steady-state power dissipation is to calculate  $I^2R$ . The one addendum to this is that MOSFETs have a slight increase in  $R_{ON}$  with increasing die temperature. A good approximation for this value is 0.5% increase in  $R_{ON}$  per °C rise in junction temperature above the point at which  $R_{ON}$  was initially specified by the manufacturer. For instance, if the selected MOSFET has a calculated  $R_{ON}$  of 10mΩ at  $T_J = 25^\circ\text{C}$ , and the actual junction temperature ends up at 110°C, a good first cut at the operating value for  $R_{ON}$  would be:

$$R_{ON} \approx 10\text{m}\Omega[1 + (110 - 25)(0.005)] \approx 14.3\text{m}\Omega$$

The final step is to make sure that the heat sinking available to the MOSFET is capable of dissipating at least as much power (rated in °C/W) as that with which the MOSFET's performance was specified by the manufacturer. Here are a few practical tips:

1. The heat from a TO-263 power MOSFET flows almost entirely out of the drain tab. If the drain tab can be soldered down to one square inch or more, the copper will act as the heat sink for the part. This copper must be on the same layer of the board as the MOSFET drain.
2. Airflow works. Even a few LFM (linear feet per minute) of air will cool a MOSFET down substantially. If you can, position the MOSFET(s) near the inlet of a power supply's fan, or the outlet of a processor's cooling fan.
3. The best test of a candidate MOSFET for an application (assuming the above tips show it to be a likely fit) is an empirical one. Check the MOSFET's temperature in the actual layout of the expected final circuit, at full operating current. The use of a thermocouple on the drain leads, or infrared pyrometer on the package, will then give a reasonable idea of the device's junction temperature.

### Power MOSFET Transient Thermal Issues

If the prospective MOSFET has been shown to withstand the environmental voltage stresses and the worst-case steady-state power dissipation is addressed, the remaining task is to verify if the MOSFET is capable of handling extreme overcurrent load faults, such as a short circuit, without overheating. A power MOSFET can handle a much

higher pulsed power without damage than its continuous power dissipation ratings imply due to an inherent trait, thermal inertia. With respect to the specification and use of power MOSFETs, the parameter of interest is the “Transient Thermal Impedance”, or  $Z_{\theta}$ , which is a real number (variable factor) used as a multiplier of the thermal resistance ( $R_{\theta}$ ). The multiplier is determined using the given “Transient Thermal Impedance Graph”, normalized to  $R_{\theta}$ , that displays curves for the thermal impedance versus power pulse duration and duty cycle. The single-pulse curve is appropriate for most hot swap applications.  $Z_{\theta}$  is specified from junction-to-case for power MOSFETs typically used in telecom applications.

The following example provides a method for estimating the peak junction temperature of a power MOSFET in determining if the MOSFET is suitable for a particular application.  $V_{IN}$  ( $V_{DD} - V_{EE}$ ) = 48V,  $I_{LIM} = 4.2A$ ,  $t_{FLT}$  is 20ms, and the power MOSFET is the SUM110N10-09 (TO-263 package) from Vishay-Siliconix. This MOSFET has an  $R_{ON}$  of 9.5m $\Omega$  ( $T_J = 25^{\circ}C$ ), the junction-to-case thermal resistance ( $R_{\theta(J-C)}$ ) is 0.4 $^{\circ}C/W$ , junction-to-ambient thermal resistance ( $R_{\theta(J-A)}$ ) is 40 $^{\circ}C/W$ , and the Transient Thermal Impedance Curve is shown in Figure 8. Consider, say, the MOSFET is switched on at time t1 and the steady-state load current passing through the MOSFET is 3A. At some point in time after t1, at time t2, there is an unexpected short-circuit applied to the load, causing the MIC2589/MIC2595 controller to adjust the GATE output voltage and regulate the load current for 20ms at the programmed current limit value, 4.2A in this example. During this short-circuit load condition, the dissipation in the MOSFET is calculated by:

$$P_D(\text{short}) = V_{DS} \times I_{LIM}; V_{DS} = 0V - (-48V) = 48V$$

$$P_D(\text{short}) = 48V \times 4.2A = 201.6W \text{ for } 20ms.$$

At first glance, it would appear that a very hefty MOSFET is required to withstand this extreme overload condition. Upon further examination, the calculation to approximate the peak junction temperature is not a difficult task. The first step is to determine the maximum steady-state junction temperature, then add the rise in temperature due to the maximum power dissipated during a transient overload caused by a short circuit condition. The equation to estimate the maximum steady-state junction temperature is given by:

$$T_J(\text{steady-state}) \cong T_C(\text{max}) + \Delta T_J \tag{1}$$

$T_C(\text{max})$  is the highest anticipated case temperature, prior to an overcurrent condition, at which the MOSFET will operate and is estimated from the

following equation based on the highest ambient temperature of the system environment.

$$T_C(\text{max}) = T_A(\text{max}) + P_D \times (R_{\theta(J-A)} - R_{\theta(J-C)}) \tag{2}$$

Let's assume a maximum ambient of 60 $^{\circ}C$ . The power dissipation of the MOSFET is determined by the current through the MOSFET and the ON resistance ( $I^2R_{ON}$ ), which we will estimate at 17m $\Omega$  (specification given at  $T_J = 125^{\circ}C$ ). Using our example information and substituting into Equation 2,

$$T_C(\text{max}) = 60^{\circ}C + [(3A)^2 \times 17m\Omega] \times (40 - 0.4)^{\circ}C/W$$

$$= 66.06^{\circ}C$$

Substituting the variables into Equation 1,  $T_J$  is determined by:

$$T_J(\text{steady-state}) \cong T_C(\text{max}) + R_{ON} \times (T_C(\text{max}) - T_C) \times (0.005) \times (R_{ON}) \times [(3A)^2 \times (R_{\theta(J-A)} - R_{\theta(J-C)})]$$

$$\cong 66.06^{\circ}C + [17m\Omega + (66.06^{\circ}C - 25^{\circ}C) \times (0.005^{\circ}C) \times (17m\Omega)] \times [(3A)^2 \times (40 - 0.4)^{\circ}C/W]$$

$$\cong 66.06^{\circ}C + 7.30^{\circ}C$$

$$\cong 73.36^{\circ}C$$

Since this is not a closed-form equation, getting a close approximation may take one or two iterations. On the second iteration, start with  $T_J$  equal to the value calculated above. Doing so in this example yields;

$$T_J(\text{steady-state}) \cong 66.06^{\circ}C + [17m\Omega + (73.36^{\circ}C - 25^{\circ}C) \times (0.005^{\circ}C) \times (17m\Omega)] \times [(3A)^2 \times (40 - 0.4)^{\circ}C/W]$$

$$\cong 73.62^{\circ}C$$

Another iteration shows that the result (73.63 $^{\circ}C$ ) is converging quickly, so we'll estimate the maximum  $T_{J(\text{steady-state})}$  at 74 $^{\circ}C$ .

The use of the Transient Thermal Impedance Curves is necessary to determine the increase in junction temperature associated with a worst-case transient condition. From our previous calculation of the maximum power dissipated during a short circuit event for the MIC2589/MIC2595, we calculate the transient junction temperature increase as:

$$T_J(\text{transient}) = P_D(\text{short}) \times R_{\theta(J-C)} \times \text{Multiplier} \tag{3}$$

Assume the MOSFET has been on for a long time – several minutes or more – and delivering the steady-state load current of 3A to the load when the load is short circuited. The controller will regulate the GATE output voltage to limit the current to the programmed value of 4.2A for 20ms before immediately shutting off the output. For this situation and almost all hot swap applications, this can be considered a single pulse event as there is no significant duty cycle. From Figure 8, find the point on the X-axis (“Square-Wave Pulse Duration”) for 25ms, allowing for a 25% margin

of the  $t_{FLT}$ , and read up the Y-axis scale to find the intersection of the Single Pulse curve. This point is the normalized transient thermal impedance ( $Z_{\theta(j-c)}$ ), and the effective transient thermal impedance is the product of  $R_{\theta(j-c)}$  and the multiplier, 0.9 in this example. Solving Equation 3,  
 $T_J(\text{transient}) = (201.6W) \times (0.4^{\circ}C/W) \times 0.9 = 72.6^{\circ}C$

Finally, add this result to the maximum steady state junction temperature calculated previously to determine the estimated maximum transient junction temperature of the MOSFET:  $T_J(\text{max.transient}) = 74^{\circ}C + 72.6^{\circ}C = 146.6^{\circ}C$ , which is safely under the specified maximum junction temperature of  $200^{\circ}C$  for the SUM110N10-09.

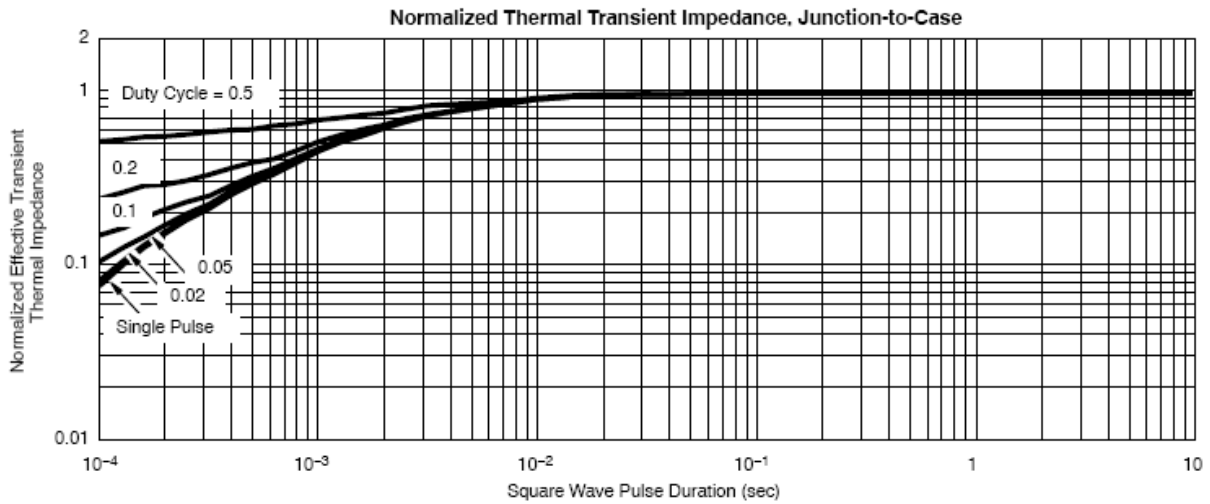

Figure 8. Transient Thermal Impedance – SUM110N10-09



## PCB Layout Considerations

### 4-Wire Kelvin Sensing

Because of the low value typically required for the sense resistor, special care must be used to measure accurately the voltage drop across it. Specifically, the measurement technique across each  $R_{SENSE}$  must employ 4-wire Kelvin sensing. This is simply a means of making sure that any voltage drops in the power traces connecting to the resistors are not picked up by the signal conductors measuring the voltages across the sense resistors.

Figure 9 illustrates how to implement 4-wire Kelvin sensing. As the figure shows, all the high current in the circuit (from  $V_{EE}$  through  $R_{SENSE}$ , and then to the source of the output MOSFET) flows directly through the power PCB traces and  $R_{SENSE}$ . The voltage drop resulting across  $R_{SENSE}$  is sampled in such a way that the high currents through the power traces will not introduce any parasitic voltage drops in the sense leads. It is recommended to connect the hot swap controller's sense leads directly to the sense resistor's metalized contact pads.

### Other Layout Considerations

Figure 10 is a suggested PCB layout diagram for the MIC2589/MIC2595. Many hot swap applications will require load currents of several amperes. Therefore,

the power ( $V_{EE}$  and Return) trace widths ( $W$ ) need to be wide enough to allow the current to flow while the rise in temperature for a given copper plate (e.g., 1oz. or 2oz.) is kept to a maximum of 10°C to 25°C. The return (or power ground) trace should be the same width as the positive voltage power traces (input/load) and isolated from any ground and signal planes so that the controller's power is common mode. Also, these traces should be as short as possible in order to minimize the IR drops between the input and the load.

Finally, the use of plated-through vias will be necessary to make circuit connections to the power, ground and signal planes of multi-layer PCBs.

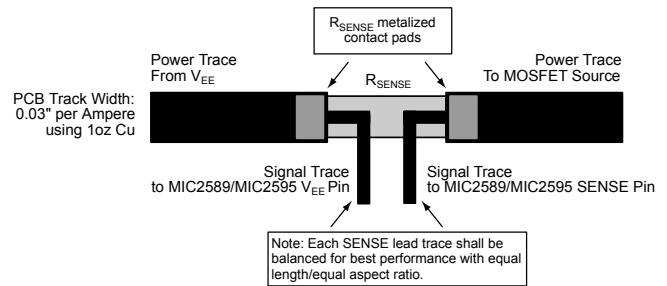

**Figure 9. 4-Wire Kelvin Sense Connections for  $R_{SENSE}$**

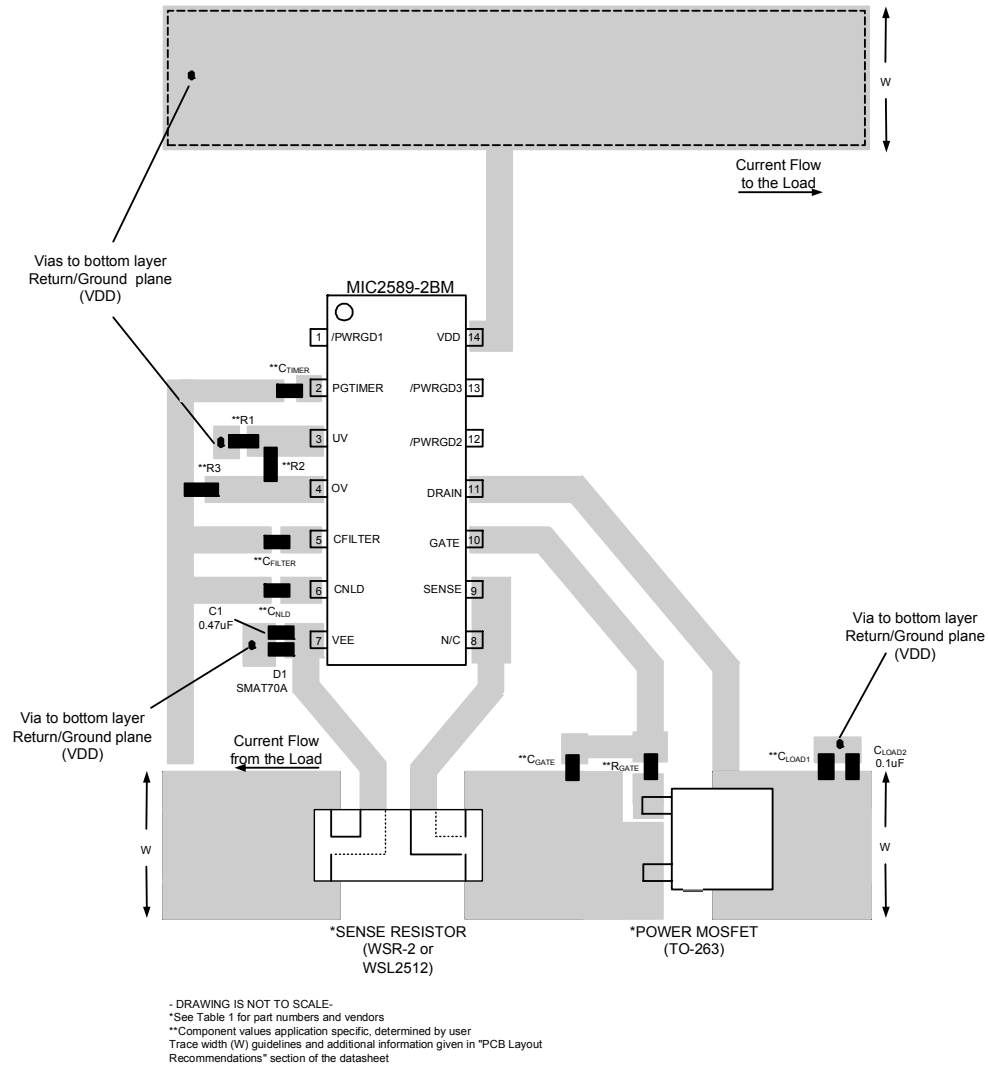

**Figure 10. Recommended PCB Layout for Sense Resistor, Power MOSFET, Overvoltage/Undervoltage Resistive Divider Network, and Timer Capacitors**

### Power-Good Signals Driving Optoisolators

The PWRGDx signals can be used to drive optoisolators or LEDs. The use of an optoisolator is sometimes needed to protect I/O signals (e.g., /PWRGD, RESET, ENABLE) of both the controller and downstream DC-DC converter(s) from damage

caused by common mode transients. Such is the case when an EMI filter is utilized to prevent DC-DC converter switching noise from being injected back onto the power supply. The circuit of Figure 11 shows how to configure an optoisolator driven by the /PWRGD signal of the MIC2589 controller.

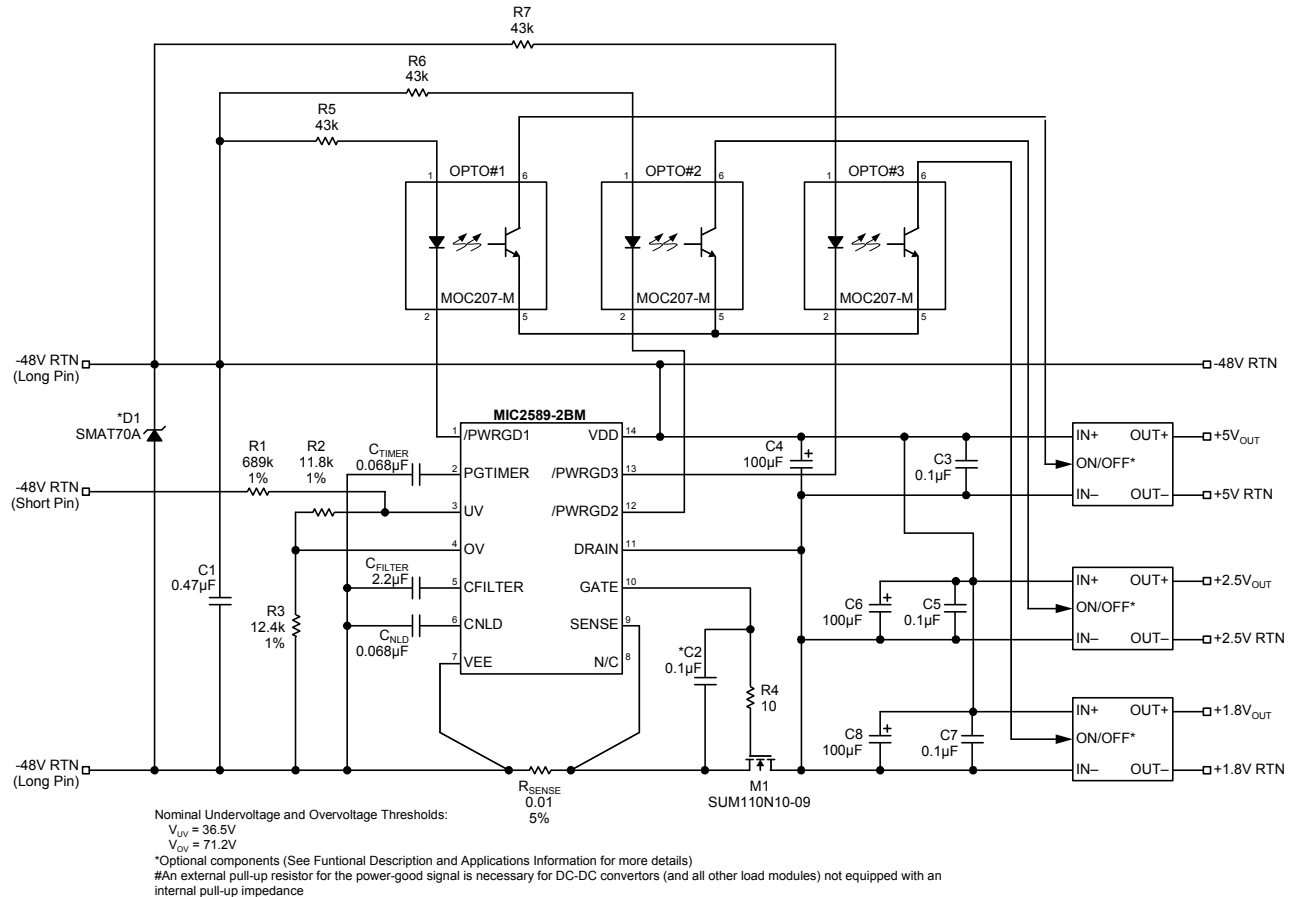

Figure 11. Optoisolators Driven by /PWRGD Signals

### MOSFET and Sense Resistor Vendors

Device types, part numbers, and manufacturer contacts for power MOSFETs and sense resistors are provided in Table 1.

MOSFET Vendors	Key MOSFET Type(s)	Breakdown Voltage (V <sub>BSS</sub> )	Contact Information
Vishay - Siliconix	SUM75N06-09L (TO-263) SUM70N06-11 (TO-263) SUM50N06-16L (TO-263)	60V 60V 60V	www.siliconix.com (203) 452-5664
	SUP85N10-10 (TO-220AB) SUB85N10-10 (TO-263) SUM110N10-09 (TO-263) SUM60N10-17 (TO-263)	100V 100V 100V 100V	www.siliconix.com (203) 452-5664
International Rectifier	IRF530 (TO-220AB) IRF540N (TO-220AB)	100V 100V	www.irf.com (310) 322-3331
Renesas	2SK1298 (TO-3PFM) 2SK1302 (TO-220AB) 2SK1304 (TO-3P)	60V 100V 100V	www.renesas.com (408) 433-1990

Resistor Vendors	Resistor Types	Contact Data
Vishay (Dale)	"WSL" Series	<a href="http://www.vishay.com/docs/wsl_30100.pdf">www.vishay.com/docs/wsl_30100.pdf</a> (203)452-5664
IRC	"OARS" Series "LR" Series (second source to "WSL")	<a href="http://www.irctt.com/pdf_files/OARS.pdf">www.irctt.com/pdf_files/OARS.pdf</a> <a href="http://www.irctt.com/pdf_files/LRC.pdf">www.irctt.com/pdf_files/LRC.pdf</a> (828) 264-8861

Table 1. MOSFET and Sense Resistors

**Package Information**

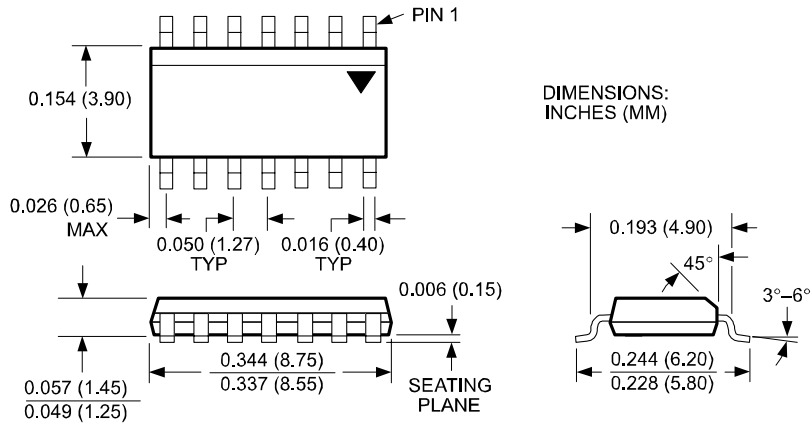

**14-Pin SOIC (M)**

**MICREL, INC. 2180 FORTUNE DRIVE SAN JOSE, CA 95131 USA**  
 TEL +1 (408) 944-0800 FAX +1 (408) 474-1000 WEB <http://www.micrel.com>

The information furnished by Micrel in this data sheet is believed to be accurate and reliable. However, no responsibility is assumed by Micrel for its use. Micrel reserves the right to change circuitry and specifications at any time without notification to the customer.

Micrel Products are not designed or authorized for use as components in life support appliances, devices or systems where malfunction of a product can reasonably be expected to result in personal injury. Life support devices or systems are devices or systems that (a) are intended for surgical implant into the body or (b) support or sustain life, and whose failure to perform can be reasonably expected to result in a significant injury to the user. A Purchaser's use or sale of Micrel Products for use in life support appliances, devices or systems is a Purchaser's own risk and Purchaser agrees to fully indemnify Micrel for any damages resulting from such use or sale.

© 2004 Micrel, Incorporated.

## Данный компонент на территории Российской Федерации

### Вы можете приобрести в компании MosChip.

Для оперативного оформления запроса Вам необходимо перейти по данной ссылке:

<http://moschip.ru/get-element>

Вы можете разместить у нас заказ для любого Вашего проекта, будь то серийное производство или разработка единичного прибора.

В нашем ассортименте представлены ведущие мировые производители активных и пассивных электронных компонентов.

Нашей специализацией является поставка электронной компонентной базы двойного назначения, продукции таких производителей как XILINX, Intel (ex.ALTERA), Vicor, Microchip, Texas Instruments, Analog Devices, Mini-Circuits, Amphenol, Glenair.

Сотрудничество с глобальными дистрибьюторами электронных компонентов, предоставляет возможность заказывать и получать с международных складов практически любой перечень компонентов в оптимальные для Вас сроки.

На всех этапах разработки и производства наши партнеры могут получить квалифицированную поддержку опытных инженеров.

Система менеджмента качества компании отвечает требованиям в соответствии с ГОСТ Р ИСО 9001, ГОСТ РВ 0015-002 и ЭС РД 009

### Офис по работе с юридическими лицами:

105318, г.Москва, ул.Щербаковская д.3, офис 1107, 1118, ДЦ «Щербаковский»

Телефон: +7 495 668-12-70 (многоканальный)

Факс: +7 495 668-12-70 (доб.304)

E-mail: [info@moschip.ru](mailto:info@moschip.ru)

Skype отдела продаж:

moschip.ru

moschip.ru\_4

moschip.ru\_6

moschip.ru\_9