



Features

- Compact design, long life and high reliability
- Vertical and horizontal mount versions
- Momentary switch
- Dual LED design
- Flatted and knurled shaft styles
- Bushing and bushingless options



PEL12D - 12 mm Encoder with Switch and Illuminated Shaft

Electrical Characteristics

| | |
|---------------------------------|-----------------------|
| Output..... | 2-bit quadrature code |
| Closed Circuit Resistance | 3 ohms maximum |
| Contact Rating..... | 0.5 mA @ 5 VDC |
| Insulation Resistance | 100 megohms @ 250 VDC |
| Dielectric Withstanding Voltage | |
| Sea Level..... | 300 VAC minimum |
| Electrical Travel | Continuous |
| Contact Bounce (15 RPM)..... | 2.0 ms. maximum** |
| RPM (Operating) | 100 maximum** |

Environmental Characteristics

| | |
|-----------------------------------|--------------------------------------|
| Operating Temperature Range | -10 °C to +70 °C (+14 °F to +158 °F) |
| Storage Temperature Range | -40 °C to +85 °C (-40 °F to +185 °F) |
| Operating Humidity..... | 25 % to 85 % R.H. |
| Rotational Life..... | 30,000 cycles minimum |
| Switch Life | 20,000 cycles minimum |
| IP Rating..... | IP 40 |

Mechanical Characteristics

| | |
|-----------------------------|--|
| Mechanical Angle | 360 ° continuous |
| Detent Torque | 30 to 200 g-cm (0.42 to 2.77 oz.-in.) |
| Running Torque | 50 g-cm (0.69 oz.-in.) maximum |
| Shaft Strength (Push)..... | 5 kgf (11.0 lbs.) |
| Shaft Strength (Pull) | 10 kgf (22.0 lbs.) |
| Weight | 3 gm (0.1 oz.) maximum |
| Terminals..... | Printed circuit board terminals |
| Soldering Condition | |
| Wave Soldering..... | Sn95.5/Ag2.8/Cu0.7 solder with no-clean flux: 260 °C max. for 5 ± 1 seconds |
| Hand Soldering | Not recommended |
| Hardware..... | One flat washer and one mounting nut supplied with each encoder with bushing |

Switch Characteristics

| | |
|-------------------------------------|--------------------------------|
| Switch Type | Contact Push ON Momentary SPST |
| Power Rating (Resistive Load) | 10 mA at 5 V DC |
| Contact Resistance | 100 milliohms |
| Switch Travel | 0.5 +0.0/-0.3 mm |
| Switch Actuation Force..... | 450 ± 200 gf (15.9 ± 7.0 oz.) |

How To Order

PEL12D - 4 0 21 F - S 1 024

Model _____

Terminal Configuration _____
 2 = Vertical Mount/Side Exit PC Pin 4 = Horizontal Mount/Rear Exit PC Pin

Detent Option _____
 0 = No Detents 2 = 24 Detents

Standard Shaft Length _____
 Flatted: Knurled:
 16 = 16.0 mm 26 = 26.0 mm 25 = 25.0 mm
 18 = 18.5 mm 31 = 31.0 mm
 21 = 21.0 mm

Shaft Style _____
 F = Insulated Flatted Shaft S = Insulated Knurled Shaft (18 Teeth)
 G = Insulated Flatted Shaft w/Bushing*** T = Insulated Knurled Shaft (18 Teeth) w/Bushing

Switch Configuration _____
 S = Push Momentary Switch

LED Color _____
 Dual:
 1 = Blue/Orange
 2 = Green/Red
 3 = Blue/Green

Resolution _____
 024 = 24 Pulses per 360 ° Rotation

*** Available in 18.5, 21 and 26 mm shaft lengths

*RoHS Directive 2002/95/EC Jan. 27, 2003 including annex and RoHS Recast 2011/65/EU June 8, 2011.

** Devices are tested using standard noise reduction filters. For optimum performance, designers should use noise reduction filters in their circuits.

Specifications are subject to change without notice.

The device characteristics and parameters in this data sheet can and do vary in different applications and actual device performance may vary over time. Users should verify actual device performance in their specific applications.

Applications

Level control, tuning and timer settings in:

- Audio-visual equipment
- Consumer electric appliances
- Musical instrumentation
- Communications equipment

PEL12D - 12 mm Encoder with Switch and Illuminated Shaft BOURNS®

Product Dimensions

PEL12D-4xxxS-Sxxxx (Horizontal Mount w/Dual LED & Switch, Knurled Shaft)

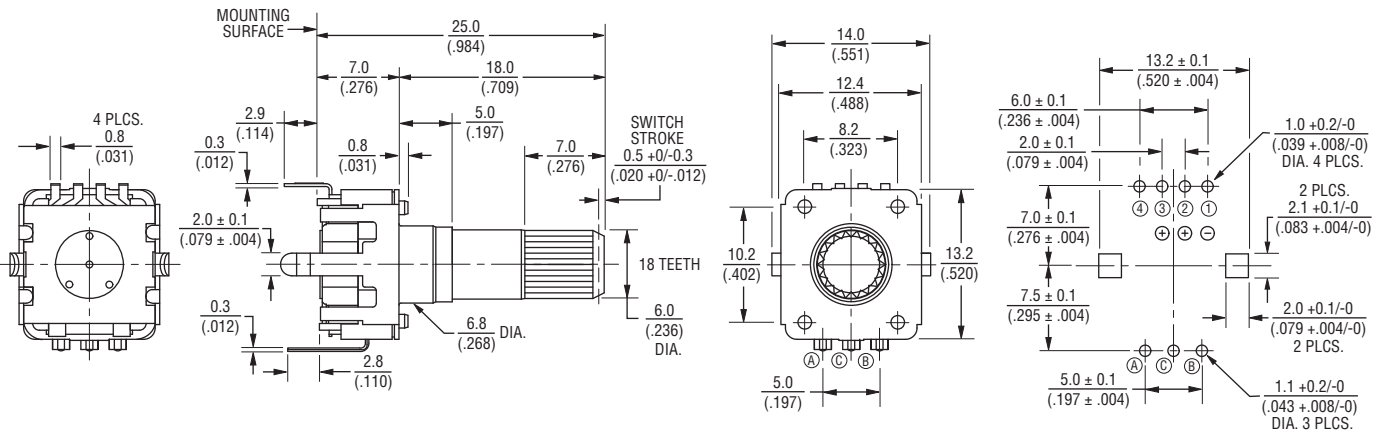

PEL12D-4xxxF-Sxxxx (Horizontal Mount w/Dual LED & Switch, Flatted Shaft)

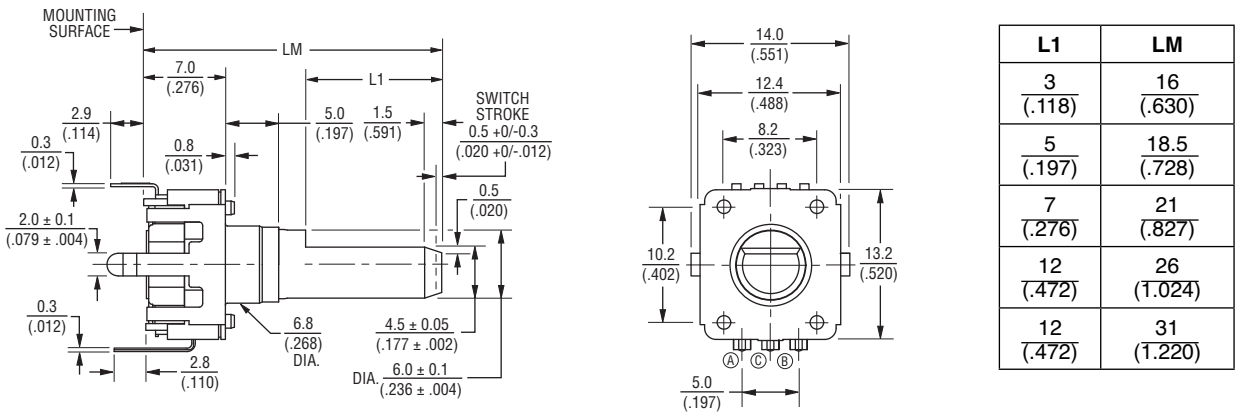

Dual LED Circuit

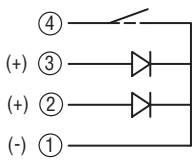

DIMENSIONS: $\frac{\text{MM}}{\text{(INCHES)}}$

TOLERANCES:
 UNDER $\frac{10.0}{(.394)} = \frac{\pm 0.3}{(\pm .012)}$ $\frac{10.0 - 100}{(.394 - 3.937)} = \frac{\pm 0.5}{(\pm .020)}$

Specifications are subject to change without notice.
 The device characteristics and parameters in this data sheet can and do vary in different applications and actual device performance may vary over time.
 Users should verify actual device performance in their specific applications.

PEL12D - 12 mm Encoder with Switch and Illuminated Shaft

BOURNS®

Product Dimensions

PEL12D-2xxxS-Sxxxx (Vertical Mount w/Dual LED & Switch, Knurled Shaft)

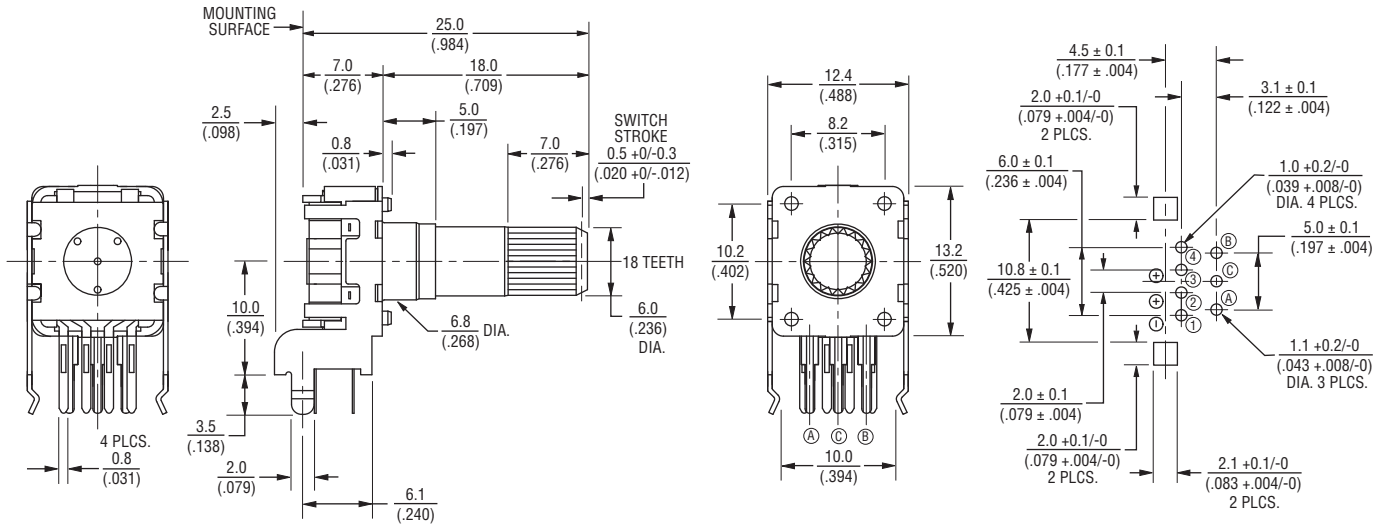

PEL12D-2xxxF-Sxxxx (Vertical Mount w/Dual LED & Switch, Flatted Shaft)

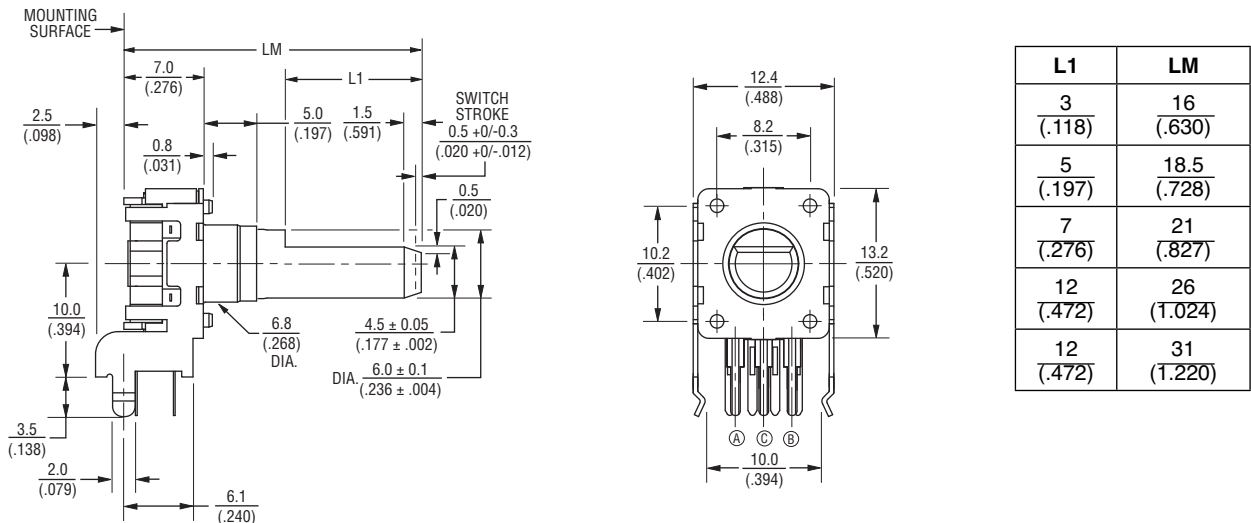

| L1 | LM |
|--------------|----------------|
| 3 (.118) | 16 (.630) |
| 5 (.197) | 18.5 (.728) |
| 7 (.276) | 21 (.827) |
| 12 (.472) | 26 (1.024) |
| 12 (.472) | 31 (1.220) |

DIMENSIONS: $\frac{\text{MM}}{\text{(INCHES)}}$

TOLERANCES:
 UNDER $\frac{10.0}{(.394)} = \frac{\pm 0.3}{(\pm 0.012)}$ $\frac{10.0 - 100}{(.394 - 3.937)} = \frac{\pm 0.5}{(\pm 0.020)}$

Specifications are subject to change without notice.

The device characteristics and parameters in this data sheet can and do vary in different applications and actual device performance may vary over time. Users should verify actual device performance in their specific applications.

PEL12D - 12 mm Encoder with Switch and Illuminated Shaft



Product Dimensions

PEL12D-4xxxT-Sxxxx (Horizontal Mount w/Dual LED & Switch, Knurled Shaft w/Bushing)



PEL12D-4xxxG-Sxxxx (Horizontal Mount w/Dual LED & Switch, Flatted Shaft w/Bushing)

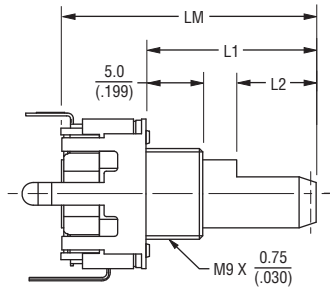

| L2 | L1 | LM |
|--------------|----------------|----------------|
| 5 (.197) | 11 (.433) | 18.5 (.728) |
| 7 (.276) | 13.5 (.532) | 21 (.827) |
| 12 (.472) | 18.5 (.728) | 26 (1.024) |

DIMENSIONS: $\frac{\text{MM}}{\text{(INCHES)}}$

TOLERANCES:
 UNDER $\frac{10.0}{(.394)} = \frac{\pm 0.3}{(\pm 0.012)}$ $\frac{10.0 - 100}{(.394 - 3.937)} = \frac{\pm 0.5}{(\pm 0.020)}$

Quadrature Output Table



Suggested Filter Circuit

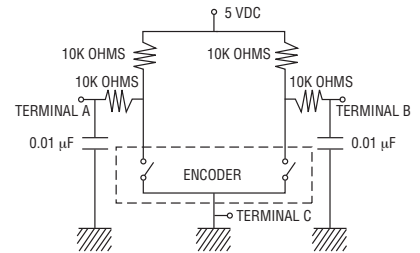

LED Terminal Decoder

| Code | Color | Terminals |
|------|---------------|-----------|
| 1 | Blue / Orange | ① ② / ① ③ |
| 2 | Green / Red | ① ② / ① ③ |
| 3 | Blue / Green | ① ② / ① ③ |

LED Characteristics (Dual)

| LED Color | | Power Dissipation (mW) | DC Forward Current (mA) | Forward Voltage (V) | |
|--------------|--------|------------------------|-------------------------|---------------------|------|
| | | | | Typ. | Max. |
| Blue/ Orange | Blue | 105 | 30 | 3.3 | 4.0 |
| | Orange | 75 | 30 | 2.1 | 2.5 |
| Green/ Red | Green | 120 | 30 | 3.2 | 4.0 |
| | Red | 75 | 30 | 1.95 | 2.5 |
| Blue/ Green | Blue | 120 | 30 | 3.3 | 4.0 |
| | Green | 120 | 30 | 3.2 | 4.0 |
| Red/ Green | Red | 75 | 30 | 1.95 | 2.5 |
| | Green | 120 | 30 | 3.2 | 4.0 |

Notes:

Reverse Current: 10 μ A
 Reverse Voltage: 5 VDC
 Test Condition (IF): 20 mA

The device characteristics and parameters in this data sheet can and do vary in different applications and actual device performance may vary over time. Users should verify actual device performance in their specific applications.



Asia-Pacific:
 Tel: +886-2 2562-4117
 Fax: +886-2 2562-4116

EMEA:
 Tel: +36 88 520 390
 Fax: +36 88 520 211

The Americas:
 Tel: +1-951 781-5500
 Fax: +1-951 781-5700

www.bourns.com

Данный компонент на территории Российской Федерации

Вы можете приобрести в компании MosChip.

Для оперативного оформления запроса Вам необходимо перейти по данной ссылке:

<http://moschip.ru/get-element>

Вы можете разместить у нас заказ для любого Вашего проекта, будь то серийное производство или разработка единичного прибора.

В нашем ассортименте представлены ведущие мировые производители активных и пассивных электронных компонентов.

Нашей специализацией является поставка электронной компонентной базы двойного назначения, продукции таких производителей как XILINX, Intel (ex.ALTERA), Vicor, Microchip, Texas Instruments, Analog Devices, Mini-Circuits, Amphenol, Glenair.

Сотрудничество с глобальными дистрибьюторами электронных компонентов, предоставляет возможность заказывать и получать с международных складов практически любой перечень компонентов в оптимальные для Вас сроки.

На всех этапах разработки и производства наши партнеры могут получить квалифицированную поддержку опытных инженеров.

Система менеджмента качества компании отвечает требованиям в соответствии с ГОСТ Р ИСО 9001, ГОСТ РВ 0015-002 и ЭС РД 009

Офис по работе с юридическими лицами:

105318, г.Москва, ул.Щербаковская д.3, офис 1107, 1118, ДЦ «Щербаковский»

Телефон: +7 495 668-12-70 (многоканальный)

Факс: +7 495 668-12-70 (доб.304)

E-mail: info@moschip.ru

Skype отдела продаж:

moschip.ru

moschip.ru_4

moschip.ru_6

moschip.ru_9