

MoCA Triplex Filter

5 - 85 / 105 - 1002 / 1125 - 1675 MHz

Rev. V3

Description

- MACOM Technology Solution's MAFL-011026 is a surface mount triplex filter designed for MoCA applications

Features

- 75 Ohm
- SMT unit
- RoHS compliant

Block Diagram

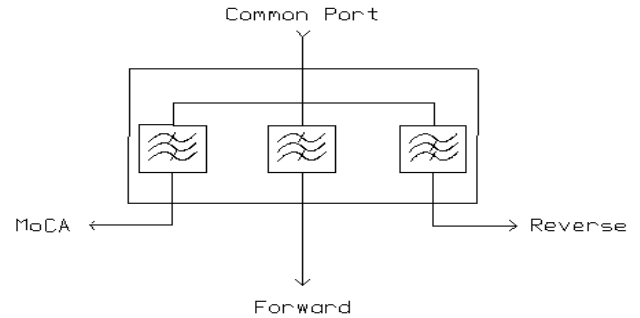

Electrical specifications: $T_A = 25^\circ\text{C}$, $Z_0 75\Omega$

Parameter	Units	Min	Typ	Max
Reverse Path Insertion loss				
5-85 MHz	dB	-	1.2	1.5
Rejection				
105-126 MHz	dB	62	70	-
126-860 MHz	dB	64	70	-
860-1002 MHz	dB	64	70	-
1125-1675 MHz	dB	60	64	-
1675-3000 MHz	dB	30	50	-
Forward path Insertion loss				
105-126 MHz	dB	-	1.5	2.0
126-860 MHz	dB	-	0.75	1.5
860-1002 MHz	dB	-	2.5	2.75
Rejection				
5-38 MHz	dB	50	55	-
38-85 MHz	dB	43	45	-
1125 - 1675 MHz	dB	43	45	-
1675-3000 MHz	dB	20	30	-
MoCA Path Insertion Loss				
1125-1150 MHz	dB	-	2.8	3.0
1150-1650 MHz	dB	-	2.5	2.7
1650-1675 MHz	dB	-	2.5	3.0
Rejection				
5-85 MHz	dB	49	70	-
85-1002 MHz	dB	49	55	-
2300-3000 MHz	dB	25	35	-

Parameter	Units	Min	Typ	Max
Input Return Loss				
5-85 MHz	dB	16	18	-
105-860MHz	dB	16	18	-
860-1002MHz	dB	12	16	-
1125-1675 MHz	dB	12	16	-
Isolation				
Forward to Reverse				
5-38 MHz	dB	55	58	-
38-85 MHz	dB	43	45	-
105-126 MHz	dB	60	65	-
126-860 MHz	dB	60	65	-
860-1002 MHz	dB	60	65	-
Forward to MoCA				
5-85 MHz	dB	49	70	-
105-126 MHz	dB	49	70	-
126-860 MHz	dB	49	53	-
860-1002 MHz	dB	49	55	-
1125-1150 MHz	dB	43	45	-
1150-1650 MHz	dB	43	50	-
1650-1675 MHz	dB	43	50	-

Pin Configuration

Function	Pin Number
MoCA Port	1
Forward Port	4
Reverse Port	7
Common Port	14
Ground	2, 3, 5, 6, 8-13, 15-20

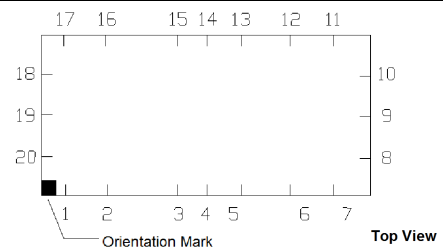

Recommended Maximum Ratings

Parameter	Absolute maximum
RF power	250mW
DC current	30mA
Operating temperature	-40°C to +85°C
Storage temperature	-40°C to +85°C

* Restrictions on Hazardous Substances, European Union Directive 2002/95/EC.

M/A-COM Technology Solutions Inc. (MACOM) and its affiliates reserve the right to make changes to the product(s) or information contained herein without notice. Visit www.macomtech.com for additional data sheets and product information.

- **North America** Tel: 800.366.2266 / Fax: 978.366.2266
- **Europe** Tel: 44.1908.574.200 / Fax: 44.1908.574.300
- **Asia/Pacific** Tel: 81.44.844.8296 / Fax: 81.44.844.8298

Filter Dimensions

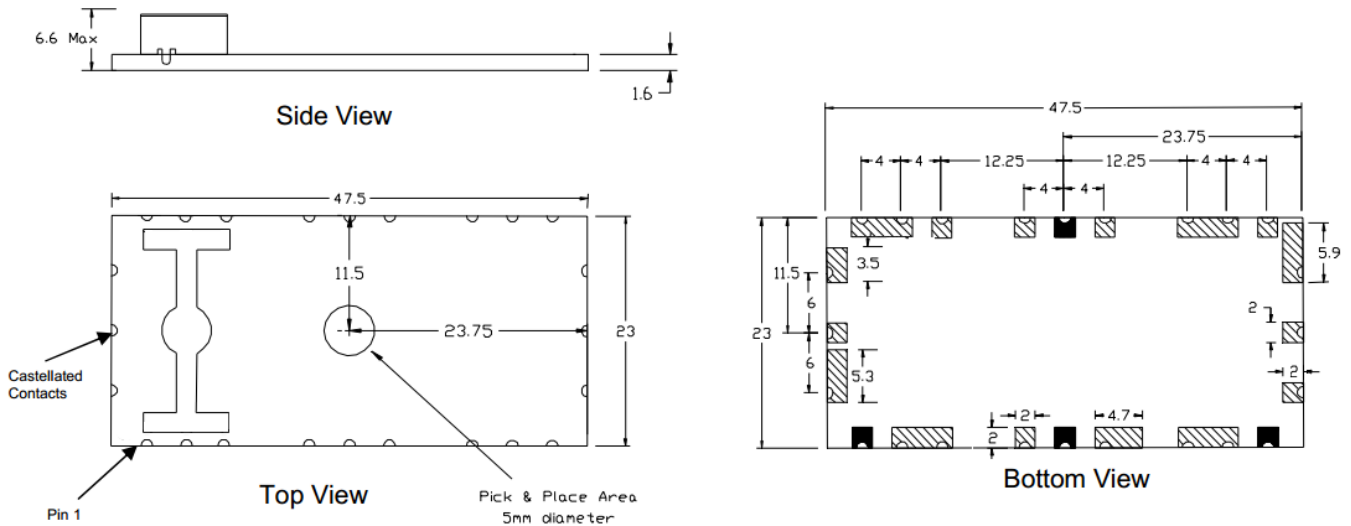

Dimensions in mm. Tolerance: .x ± 0.1 unless otherwise noted

Solder Resist Colour: Black

PCB Pad Finish: ENIG

Application Schematic

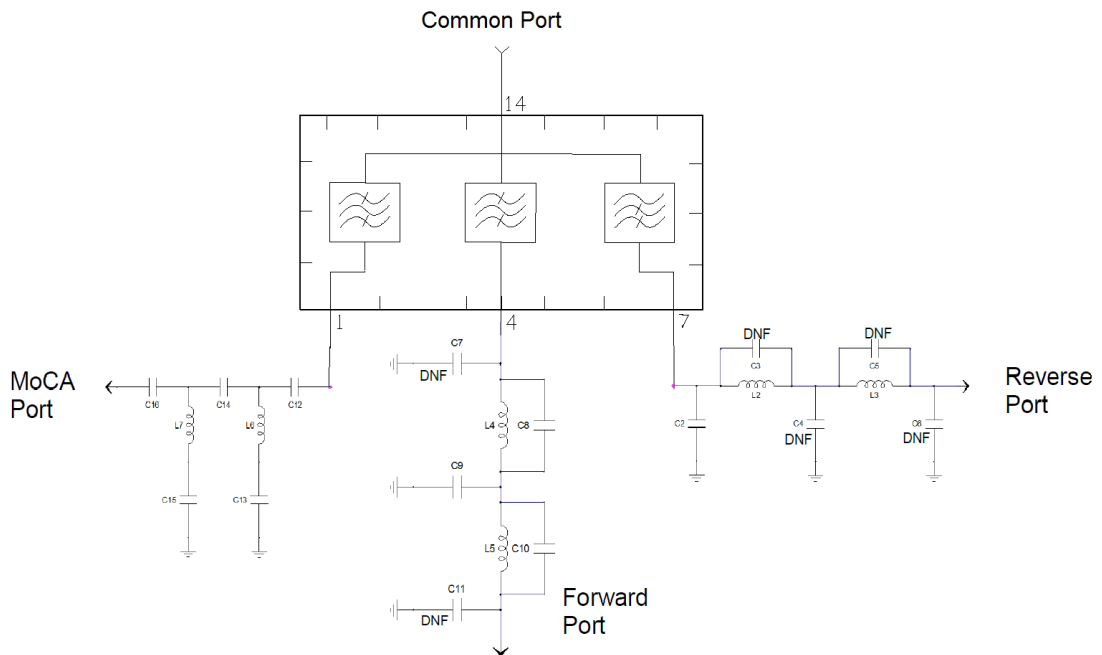

DNF: Do Not Fit

M/A-COM Technology Solutions Inc. (MACOM) and its affiliates reserve the right to make changes to the product(s) or information contained herein without notice. Visit www.macomtech.com for additional data sheets and product information.

- **North America** Tel: 800.366.2266 / Fax: 978.366.2266
- **Europe** Tel: 44.1908.574.200 / Fax: 44.1908.574.300
- **Asia/Pacific** Tel: 81.44.844.8296 / Fax: 81.44.844.8298

MoCA Triplex Filter 5 - 85 / 105 - 1002 / 1125 - 1675 MHz

Rev. V3

Common Port Return Loss

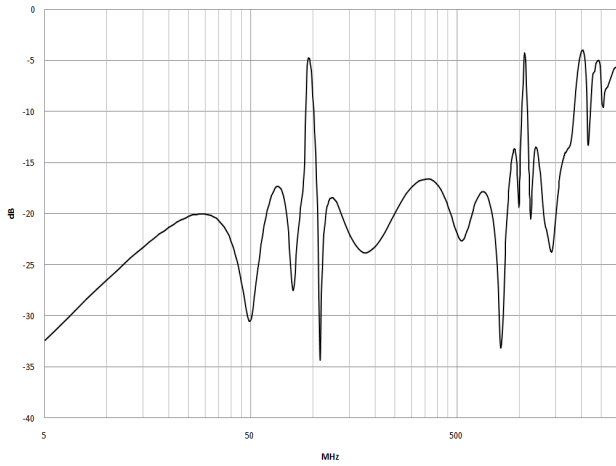

Reverse Path

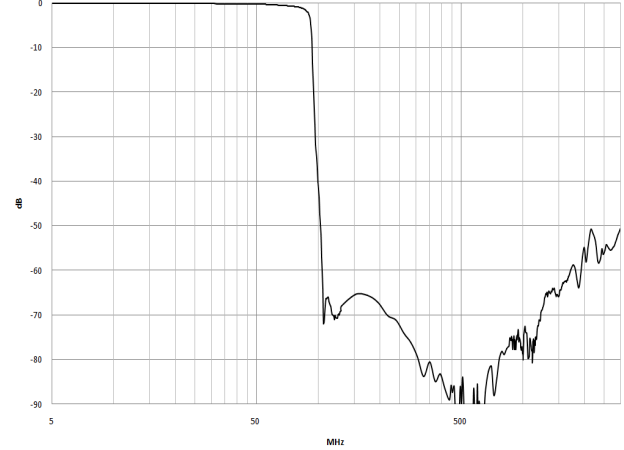

Forward Path

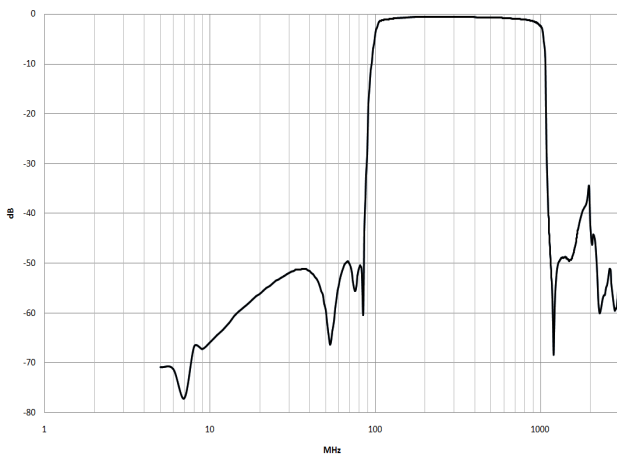

MoCA Path

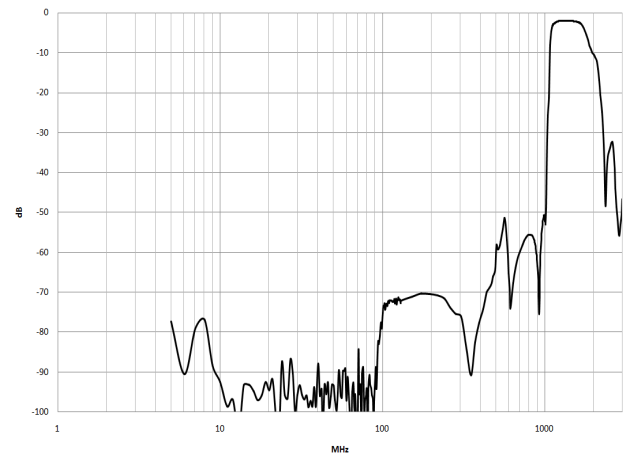

Reverse to Forward Path Isolation

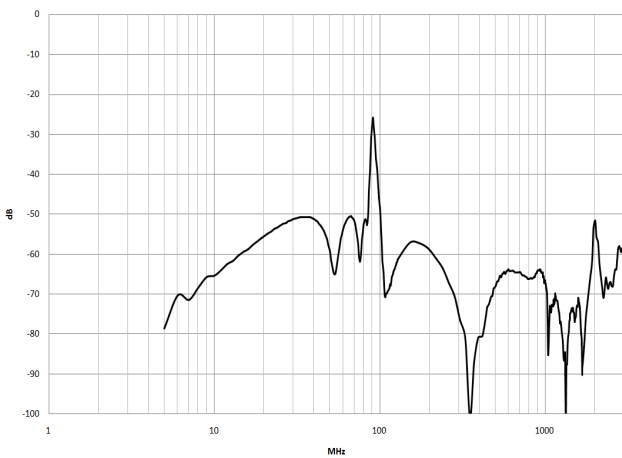

Forward to MoCA Path Isolation

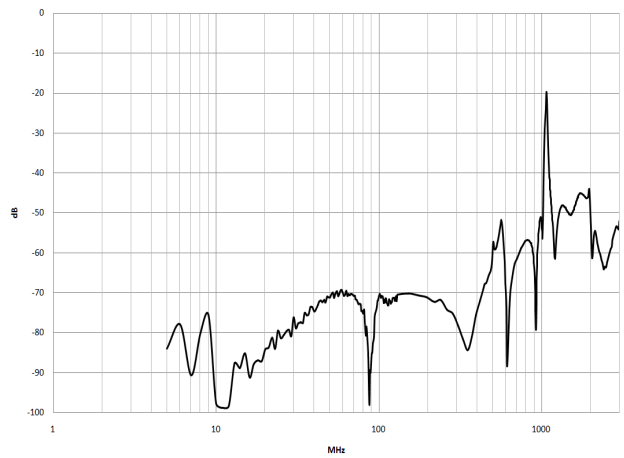

M/A-COM Technology Solutions Inc. (MACOM) and its affiliates reserve the right to make changes to the product(s) or information contained herein without notice. Visit www.macomtech.com for additional data sheets and product information.

- **North America** Tel: 800.366.2266 / Fax: 978.366.2266
- **Europe** Tel: 44.1908.574.200 / Fax: 44.1908.574.300
- **Asia/Pacific** Tel: 81.44.844.8296 / Fax: 81.44.844.8298

MAFL-011026



MoCA Triplex Filter

5 - 85 / 105 - 1002 / 1125 - 1675 MHz

Rev. V3

Tape & Reel Information

Parameter	Units	Value
Qty per reel	-	200
Reel Size	mm	330
Tape Width	mm	72.0
Pitch	mm	28.0
Ao	mm	23.3
Bo	mm	47.8
Ko	mm	6.8
Orientation	-	F54
Reference Application Note ANI-019 for orientation		

Ordering Information

Part Number	Package
MAFL-011026	Tape & Reel

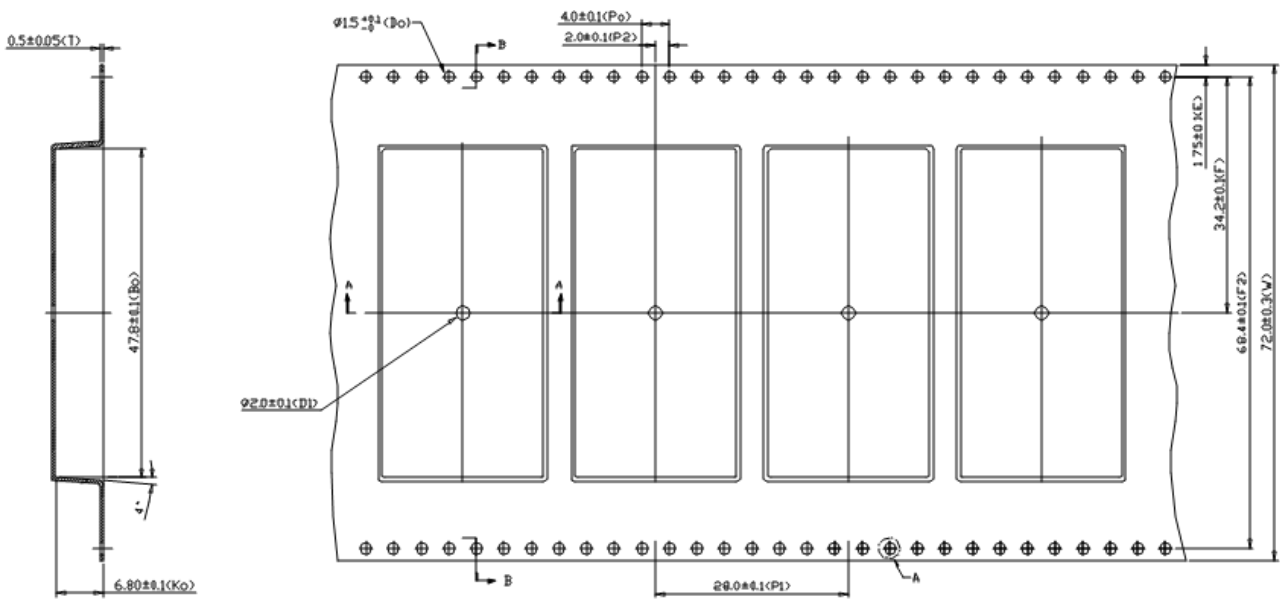

Section B-B

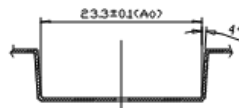

Section A-A

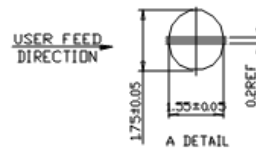

A DETAIL

M/A-COM Technology Solutions Inc. (MACOM) and its affiliates reserve the right to make changes to the product(s) or information contained herein without notice. Visit www.macomtech.com for additional data sheets and product information.

- **North America** Tel: 800.366.2266 / Fax: 978.366.2266
- **Europe** Tel: 44.1908.574.200 / Fax: 44.1908.574.300
- **Asia/Pacific** Tel: 81.44.844.8296 / Fax: 81.44.844.8298

MAFL-011026



MoCA Triplex Filter

5 - 85 / 105 - 1002 / 1125 - 1675 MHz

Rev. V3

Tray Information

Parameter	Units	Value
Min Order Qty	-	480
Tray Length	mm	270
Tray Width	mm	200
Height	mm	20.8
Ao	mm	40
Bo	mm	55
Ko	mm	7.2
Orientation	-	See below

Ordering Information

Part Number	Package
MAFL-011026-Tray	Tray

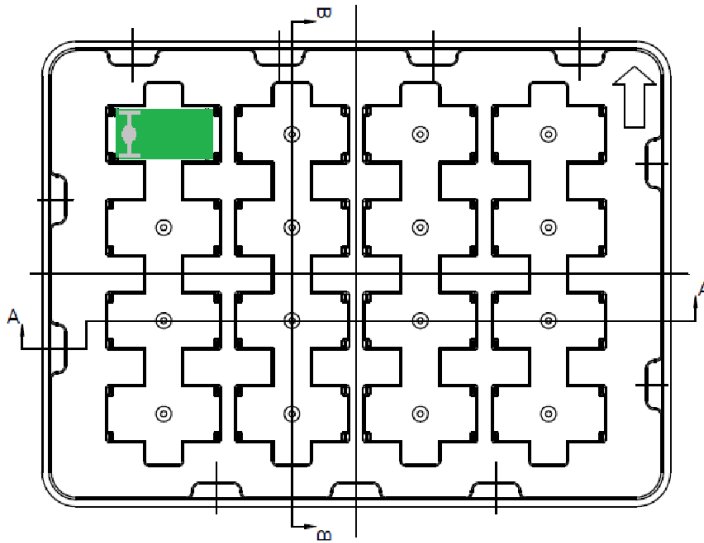

Section B-B

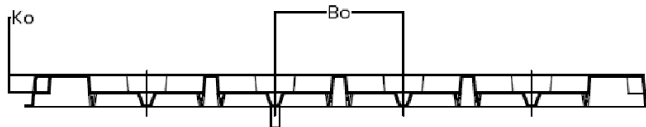

Section A-A

* Restrictions on Hazardous Substances, European Union Directive 2002/95/EC.

M/A-COM Technology Solutions Inc. (MACOM) and its affiliates reserve the right to make changes to the product(s) or information contained herein without notice. Visit www.macomtech.com for additional data sheets and product information.

- **North America** Tel: 800.366.2266 / Fax: 978.366.2266
- **Europe** Tel: 44.1908.574.200 / Fax: 44.1908.574.300
- **Asia/Pacific** Tel: 81.44.844.8296 / Fax: 81.44.844.8298

Данный компонент на территории Российской Федерации

Вы можете приобрести в компании MosChip.

Для оперативного оформления запроса Вам необходимо перейти по данной ссылке:

<http://moschip.ru/get-element>

Вы можете разместить у нас заказ для любого Вашего проекта, будь то серийное производство или разработка единичного прибора.

В нашем ассортименте представлены ведущие мировые производители активных и пассивных электронных компонентов.

Нашей специализацией является поставка электронной компонентной базы двойного назначения, продукции таких производителей как XILINX, Intel (ex.ALTERA), Vicor, Microchip, Texas Instruments, Analog Devices, Mini-Circuits, Amphenol, Glenair.

Сотрудничество с глобальными дистрибьюторами электронных компонентов, предоставляет возможность заказывать и получать с международных складов практически любой перечень компонентов в оптимальные для Вас сроки.

На всех этапах разработки и производства наши партнеры могут получить квалифицированную поддержку опытных инженеров.

Система менеджмента качества компании отвечает требованиям в соответствии с ГОСТ Р ИСО 9001, ГОСТ РВ 0015-002 и ЭС РД 009

Офис по работе с юридическими лицами:

105318, г.Москва, ул.Щербаковская д.3, офис 1107, 1118, ДЦ «Щербаковский»

Телефон: +7 495 668-12-70 (многоканальный)

Факс: +7 495 668-12-70 (доб.304)

E-mail: info@moschip.ru

Skype отдела продаж:

moschip.ru

moschip.ru_4

moschip.ru_6

moschip.ru_9