

FCI PART NUMBER	DESCRIPTION	NOTES
10122527-XXXXLF	CONTROLLER TO BACKPLANE CONFIGURATION	SEE TABLE 2

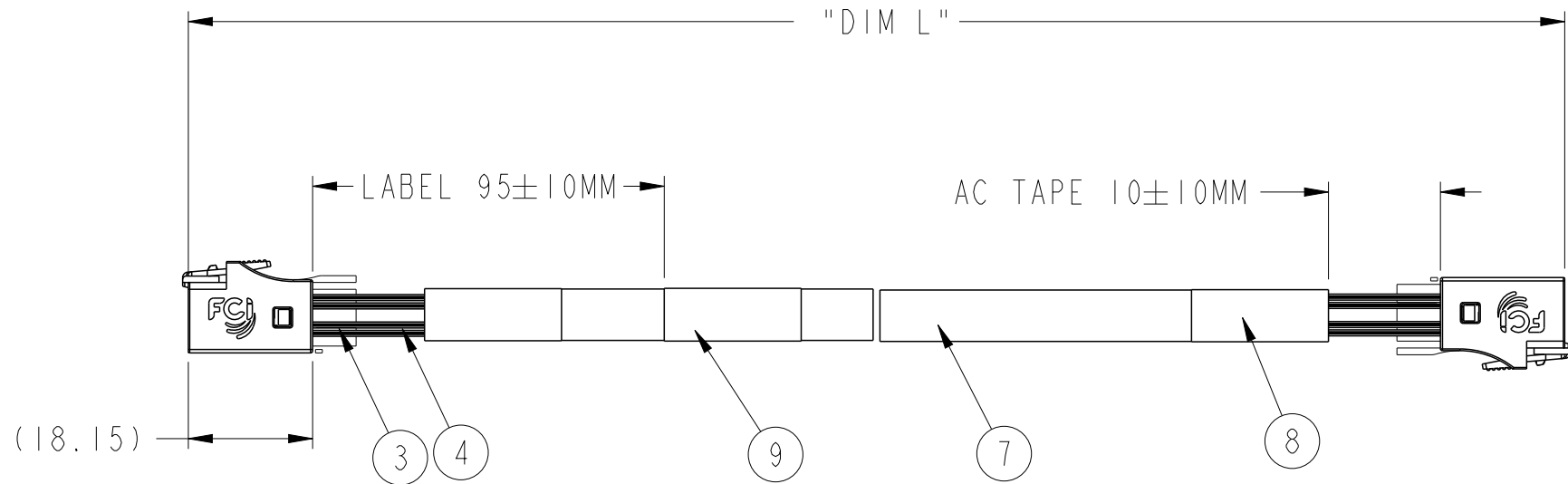
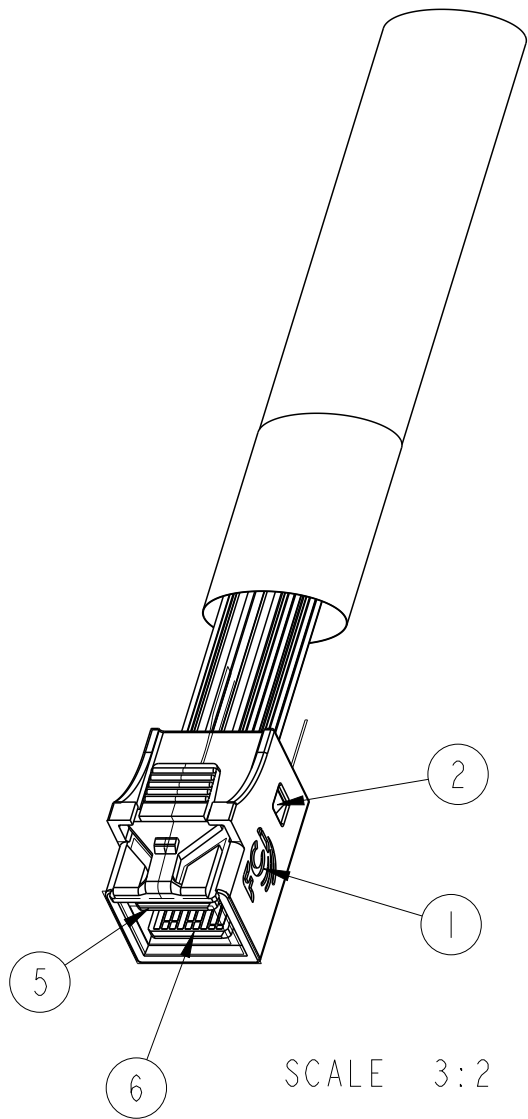

TABLE 1 - BILL OF MATERIALS

ITEM	DESCRIPTION	QTY	NOTES
1	mSAS HD INTERNAL HOUSING- SHORT	2	
2	mSAS HD INTERNAL PCB INSERT- SHORT	2	
3	3M FLAT RIBBON CABLE (30 AWG)	A/R	
4	SIDE BAND FLAT RIBBON CABLE (30 AWG)	A/R	
5	mSAS HD INTERNAL LOWER (A-B) PCB	2	
6	mSAS HD INTERNAL UPPER (C-D) PCB	2	
7	PLASTIC BRAID	A/R	
8	ACETATE TAPE 20mm BLACK	A/R	
9	LABEL	1	SEE NOTE 5
10	3525 LOCTITE	A/R	NOT SHOWN

spec ref	-	dr	Andy Wu	2013/01/03	projection	mm	size	A3	scale	1:1
tolerance std	ISO 406 ISO 1101	eng	Ya LI	2015/04/28			ecn no	ELX-N-20750-1		
TOLERANCES UNLESS OTHERWISE SPECIFIED		chr	-	apppr			Delhy Liu	2015/04/28	product family	-
surface	ISO 1302	linear	0.X	±0.3			mSAS HD INTERNAL (4i)		dwg no 10122527	rev J
			0.XX	±0.10			CABLE ASSEMBLY- 12 Gb/s, short type			
		angular	0°	±2°			cat. no.	-		

FCI PART NUMBER	DESCRIPTION	NOTES
10122527-XXXXLF	CONTROLLER TO BACKPLANE CONFIGURATION	SEE TABLE 2

TABLE 2- CABLE PART NUMBER LIST			
PART NUMBER	"DIM L" CABLE LENGTH (METERS)	AWG	NOTES
10122527-2030LF	0.3	30	CONTROLLER TO BACKPLANE WIRING CONFIGURATION (SHEET 2) ----- (SEE SHEET 4 FOR ALL NOTES)
10122527-2040LF	0.4	30	
10122527-2050LF	0.5	30	
10122527-2060LF	0.6	30	
10122527-2070LF	0.7	30	
10122527-2075LF	0.75	30	
10122527-2080LF	0.8	30	
10122527-2090LF	0.9	30	
10122527-2100LF	1.0	30	
10122527-2035LF	0.35	30	
10122527-2043LF	0.436	30	
10122527-2095LF	0.95	30	



- NOTE:
1. ALL CABLE PERFORMANCE COMPLIANCE SAS3.0
  2. CABLE MORE THAN 1.0 METER COULD NOT MEET SAS3.0 INSERTION LOSS -11dB MAX.

spec ref	-	dr	Andy Wu	2013/01/03	projection	mm	size	A3	scale	1:2					
tolerance std	ISO 406 ISO 1101	eng	Ya Li	2015/04/28			ecn no	ELX-N-20750-1							
	TOLERANCES UNLESS OTHERWISE SPECIFIED	chr	-	-			product family	-	rel level	Released					
surface	ISO 1302	appr	Delhy Liu	2015/04/28			title	mSAS HD INTERNAL (4i) CABLE ASSEMBLY- 12 Gb/s, short type		rev	J				
	linear	0.X	±0.3	0.XX	±0.10	0.XXX	±0.005	angular	0°	±2°	www.fci.com	cat. no.	-	Product - Customer Drw	sheet 2 of 4



Copyright FCI.

FCI PART NUMBER	DESCRIPTION	NOTES
10122527-XXXXLF	CONTROLLER TO BACKPLANE CONFIGURATION	SEE TABLE 2

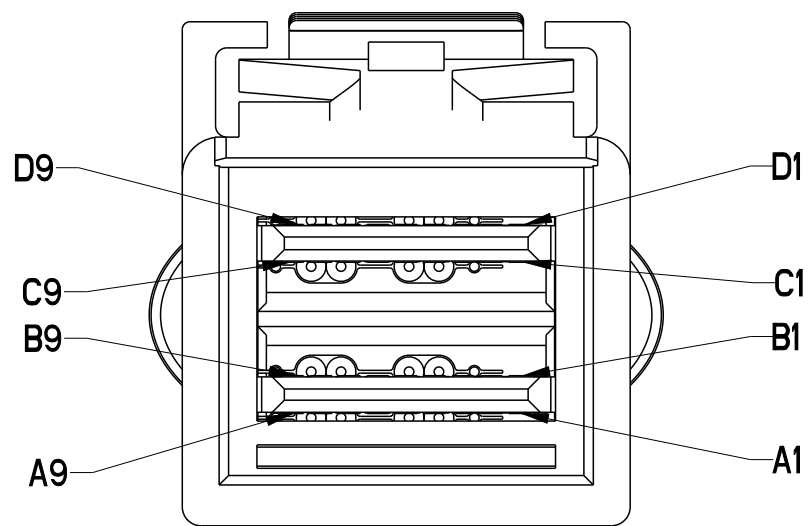

SCALE 5:1

LEGEND	
	HIGH-SPEED SERIAL DIFFERENTIAL PAIRS
	SIGNAL RETURN
	SIDEBAND SIGNAL

WIRING LIST (CONTROLLER TO BACKPLANE)				
END P1 (CONTROLLER)			END P2 (BACKPLANE)	
POSITION	SYMBOL		POSITION	SYMBOL
D9	GROUND	-----	B9	GROUND
D8	Tx2-		B8	Rx2-
D7	Tx2+		B7	Rx2+
D6	GROUND	-----	B6	GROUND
D5	Tx0-		B5	Rx0-
D4	Tx0+		B4	Rx0+
D3	GROUND	-----	B3	GROUND
D2	SIDEBAND 6		D1	SIDEBAND 6
D1	SIDEBAND 5		D2	SIDEBAND 5
C1	SIDEBAND 4		C2	SIDEBAND 4
C2	SIDEBAND 2		C1	SIDEBAND 2
C3	GROUND	-----	A3	GROUND
C4	Tx1+		A4	Rx1+
C5	Tx1-		A5	Rx1-
C6	GROUND	-----	A6	GROUND
C7	Tx3+		A7	Rx3+
C8	Tx3-		A8	Rx3-
C9	GROUND	-----	A9	GROUND
B9	GROUND	-----	D9	GROUND
B8	Rx2-		D8	Tx2-
B7	Rx2+		D7	Tx2+
B6	GROUND	-----	D6	GROUND
B5	Rx0-		D5	Tx0-
B4	Rx0+		D4	Tx0+
B3	GROUND	-----	D3	GROUND
B2	SIDEBAND 1		B1	SIDEBAND 1
B1	SIDEBAND 3		B2	SIDEBAND 3
A1	SIDEBAND 7		A2	SIDEBAND 7
A2	SIDEBAND 0		A1	SIDEBAND 0
A3	GROUND	-----	C3	GROUND
A4	Rx1+		C4	Tx1+
A5	Rx1-		C5	Tx1-
A6	GROUND	-----	C6	GROUND
A7	Rx3+		C7	Tx3+
A8	Rx3-		C8	Tx3-
A9	GROUND	-----	C9	GROUND

spec ref	-	dr	Andy Wu	2013/01/03	projection	mm	size	A3	scale	1:1
tolerance std	ISO 406 ISO 1101	eng	Ya Li	2015/04/28		← →	ecn no	ELX-N-20750-1	rel level	Released
TOLERANCES UNLESS OTHERWISE SPECIFIED		chr	-	2015/04/28						
surface	ISO 1302	appr	Delhly Liu	2015/04/28	mSAS HD INTERNAL (4i)		10122527		rev	J
	linear	0.X	±0.3		CABLE ASSEMBLY- 12 Gb/s, short type				sheet 3 of 4	
		0.XX	±0.10		www.fci.com					
	angular	0°	±2°		cat. no.		Product - Customer Drw			



NOTES:

1. MATERIAL:  
 HOUSINGS: MODIFIED POLYPHENYLENE ETHER  
 PADDLE CARD: PRINTED CIRCUIT SUBSTRATE  
 HEAT SHRINK TUBE: POLYOLEFIN  
 EPOXY LOCTITE

2. THIS PRODUCT MEETS THE RESTRICTION OF HAZARDOUS SUBSTANCES IN ELECTRICAL AND ELECTRONIC EQUIPMENT (RoHS) DIRECTIVE (2002/95/EC)

3. THIS DIMENSION IS A FINISHED PRODUCT LENGTH.

4. UNLESS OTHERWISE SPECIFIED ASSEMBLED LENGTH TOLERANCE IS TO BE:  
 "DIM L" < 1 METER = 25mm  
 "DIM L" 1 METER TO 10 METERS = 2% OF "DIM L"

5. UNLESS OTHERWISE SPECIFIED LABEL POSITION IS TO BE 95mm FROM REAR OF PI CONNECTOR.  
 LABEL DETAILS:  
 MANUFACTURER CODE OR NAME COUNTRY OF ORIGIN  
 CUSTOMER P/N OR FCI P/N  
 REVISION  
 DATE CODE (YYYY/MM/DD FORMAT) - SERIAL NUMBER

FONT SHALL BE CLEARLY VISIBLE AND BLACK IN COLOR.

6. ALL CABLE ASSEMBLIES SHALL BE 100% TESTED FOR CONTINUITY AS DEFINED IN WIRING LIST.

7. ALL CABLE ASSEMBLIES SHALL BE 100% HI-POT TESTED BH APPLYING 300V DC FOR A MINIMUM OF 10ms.

8. IMPEDANCE: 100 DIFFERENTIAL.

9. OTHER TESTING PERFORMED AS REQUIRED BY PRODUCT SPECIFICATION: GS-12-650.

10. PACKAGE AND LABEL CABLE ASSEMBLIES PER GS-14-1272.





11. A "  " SYMBOL WILL BE NEXT TO ANY DIMENSION, VIEW, OR NOTE WHICH HAS BEEN MODIFIED WITH THE CURRENT DRAWING REVISION. THE CURRENT REVISION WILL BE SHOWN IN THE SYMBOL.

12. "HLF" PRODUCT NUMBERS DESIGNATE THE USE OF HALOGEN FREE RAW CABLE.

13. HALOGEN FREE RAW CABLE CAN BE USED AS A SUBSTITUTE ON NON-HF PRODUCT NUMBERS.

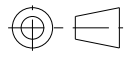
14. PART NUMBER/SUPPLIER SUBSTITUTION IS NOT ALLOWED.

15. THIS PRODUCT CONFORMS TO THE MECHANICAL DIMENSIONING AND ELECTRICAL REQUIREMENTS OF THE SFF-8643 SPECIFICATION.

spec ref		-		dr	Andy Wu	2013/01/03	projection 	mm 	size	A3	scale	1:1	
tolerance std		TOLERANCES UNLESS OTHERWISE SPECIFIED		eng	Ya Li	2015/04/28			ecn no	ELX-N-20750-1			
ISO 406 ISO 1101				chr	-	-			product family	rel level <b>Released</b>			
surface 	linear	0.X	±0.3		mSAS HD INTERNAL (4i)	cat. no.	-	Product - Customer Drw	dwg no	10122527	rev	<b>J</b>	
		0.XX	±0.10										
		0.XXX	±0.005										
ISO 1302	angular	0°	±2°	www.fci.com	-		sheet 4 of 4						



Copyright FCI.

## Данный компонент на территории Российской Федерации

### Вы можете приобрести в компании MosChip.

Для оперативного оформления запроса Вам необходимо перейти по данной ссылке:

<http://moschip.ru/get-element>

Вы можете разместить у нас заказ для любого Вашего проекта, будь то серийное производство или разработка единичного прибора.

В нашем ассортименте представлены ведущие мировые производители активных и пассивных электронных компонентов.

Нашей специализацией является поставка электронной компонентной базы двойного назначения, продукции таких производителей как XILINX, Intel (ex.ALTERA), Vicor, Microchip, Texas Instruments, Analog Devices, Mini-Circuits, Amphenol, Glenair.

Сотрудничество с глобальными дистрибьюторами электронных компонентов, предоставляет возможность заказывать и получать с международных складов практически любой перечень компонентов в оптимальные для Вас сроки.

На всех этапах разработки и производства наши партнеры могут получить квалифицированную поддержку опытных инженеров.

Система менеджмента качества компании отвечает требованиям в соответствии с ГОСТ Р ИСО 9001, ГОСТ РВ 0015-002 и ЭС РД 009

### Офис по работе с юридическими лицами:

105318, г.Москва, ул.Щербаковская д.3, офис 1107, 1118, ДЦ «Щербаковский»

Телефон: +7 495 668-12-70 (многоканальный)

Факс: +7 495 668-12-70 (доб.304)

E-mail: [info@moschip.ru](mailto:info@moschip.ru)

Skype отдела продаж:

moschip.ru

moschip.ru\_4

moschip.ru\_6

moschip.ru\_9