



Optocoupler, Phototransistor Output, Low Input Current



FEATURES

- Good CTR linearity depending on forward current
- Low CTR degradation
- High collector emitter voltage, $V_{CEO} = 55\text{ V}$
- Isolation test voltage, 5300 V_{RMS}
- Low coupling capacitance
- End stackable, 0.100" (2.54 mm) spacing
- High common mode transient immunity
- Material categorization: For definitions of compliance please see www.vishay.com/doc?99912



RoHS COMPLIANT

APPLICATIONS

- Telecom
- Industrial controls
- Battery powered equipment
- Office machines

AGENCY APPROVALS

- UL1577, file no. E52744 system code H or J, double protection
- CSA 93751
- DIN EN 60747-5-5 (VDE 0884-5) available with option 1
- BSI IEC 60950; IEC 60065
- FIMKO

DESCRIPTION

The SFH618A (DIP) and SFH6186 (SMD) feature a high current transfer ratio, low coupling capacitance and high isolation voltage. These couplers have a GaAs infrared diode emitter, which is optically coupled to silicon planar phototransistor detector, and is incorporated in a plastic DIP-4 or SMD package.

The coupling devices are designed for signal transmission between two electrically separated circuits. The couplers are end-stackable with 2.54 mm lead spacing. Creepage and clearance distances of > 8 mm achieved with option 6.

ORDERING INFORMATION

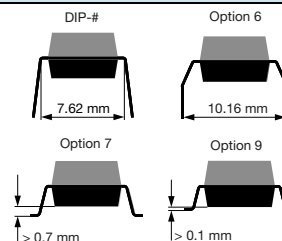
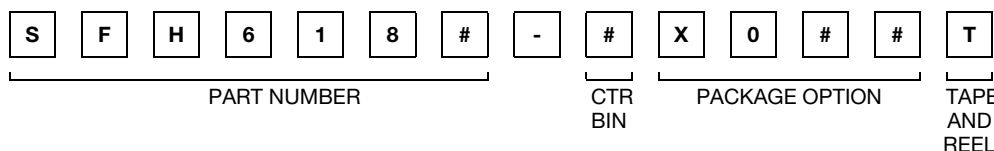

| AGENCY CERTIFIED/PACKAGE | CTR (%) | | | |
|--------------------------|---------------------------|--|---------------------------|---|
| | 1 mA | | | |
| UL, CUL | 63 to 125 | 100 to 200 | 160 to 320 | 250 to 500 |
| DIP-4 | SFH618A-2 | SFH618A-3 | SFH618A-4 | SFH618A-5 |
| DIP-4, 400 mil, option 6 | - | SFH618A-3X006 | - | - |
| SMD-4, option 7 | - | - | - | SFH618A-5X007T ⁽¹⁾ |
| SMD-4, option 9 | SFH6186-2T ⁽¹⁾ | SFH6186-3T ⁽¹⁾ , SFH6186-3T1 ⁽²⁾ , SFH6186-3X002T ⁽¹⁾ | SFH6186-4T ⁽¹⁾ | SFH6186-5T ⁽¹⁾ , SFH6186-5T1 ⁽²⁾ |
| VDE, UL, CUL | 63 to 125 | 100 to 200 | 160 to 320 | 250 to 500 |
| DIP-4 | - | SFH618A-3X001 | SFH618A-4X001 | - |
| DIP-4, 400 mil, option 6 | - | SFH618A-3X016 | SFH618A-4X016 | SFH618A-5X016 |
| SMD-4, option 7 | - | SFH618A-3X017T ⁽¹⁾ | - | SFH618A-5X017T ⁽¹⁾ |
| SMD-4, option 9 | - | SFH6186-3X001T ⁽¹⁾ | SFH6186-4X001T | SFH6186-5X001T ⁽¹⁾ |

Notes

- Additional options may be possible, please contact sales office
- ⁽¹⁾ Also available in tubes, do not put T to the end
- ⁽²⁾ Product is rotated 180° in tape and reel cavity



| ABSOLUTE MAXIMUM RATINGS ($T_{amb} = 25\text{ }^{\circ}\text{C}$, unless otherwise specified) | | | | |
|---|---|------------|----------------|--------------------|
| PARAMETER | TEST CONDITION | SYMBOL | VALUE | UNIT |
| INPUT | | | | |
| Reverse voltage | | V_R | 6 | V |
| Power dissipation | | P_{diss} | 70 | mW |
| Forward current | | I_F | 60 | mA |
| OUTPUT | | | | |
| Collector emitter voltage | | V_{CEO} | 55 | V |
| Emitter collector voltage | | V_{ECO} | 7 | V |
| Collector current | | I_C | 50 | mA |
| | $t_p \leq 1\text{ ms}$ | I_C | 100 | mA |
| Power dissipation | | P_{diss} | 150 | mW |
| COUPLER | | | | |
| Isolation test voltage between emitter and detector | $t = 1\text{ s}$ | V_{ISO} | 5300 | V_{RMS} |
| Isolation resistance | $V_{IO} = 500\text{ V}, T_{amb} = 25\text{ }^{\circ}\text{C}$ | R_{IO} | $\geq 10^{12}$ | Ω |
| | $V_{IO} = 500\text{ V}, T_{amb} = 100\text{ }^{\circ}\text{C}$ | R_{IO} | $\geq 10^{11}$ | Ω |
| Storage temperature range | | T_{stg} | - 55 to + 150 | $^{\circ}\text{C}$ |
| Ambient temperature range | | T_{amb} | - 55 to + 100 | $^{\circ}\text{C}$ |
| Junction temperature | | T_j | 125 | $^{\circ}\text{C}$ |
| Soldering temperature ⁽¹⁾ | max. 10 s, dip soldering distance to seating plane $\geq 1.5\text{ mm}$ | T_{sld} | 260 | $^{\circ}\text{C}$ |

Notes

- Stresses in excess of the absolute maximum ratings can cause permanent damage to the device. Functional operation of the device is not implied at these or any other conditions in excess of those given in the operational sections of this document. Exposure to absolute maximum ratings for extended periods of the time can adversely affect reliability.
- ⁽¹⁾ Refer to reflow profile for soldering conditions for surface mounted devices (SMD). Refer to wave profile for soldering conditions for through hole devices (DIP).

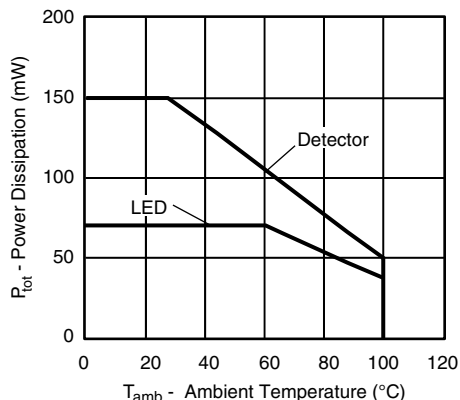

Fig. 1 - Permissible Power Dissipation vs. Ambient Temperature



| ELECTRICAL CHARACTERISTICS (T _{amb} = 25 °C, unless otherwise specified) | | | | | | | | |
|---|---|-----------|--------------------|----------------|------|------|------|----|
| PARAMETER | TEST CONDITION | PART | SYMBOL | MIN. | TYP. | MAX. | UNIT | |
| INPUT | | | | | | | | |
| Forward voltage | I _F = 5 mA | | V _F | | 1.1 | 1.5 | V | |
| Reverse current | V _R = 6 V | | I _R | | 0.01 | 10 | μA | |
| Capacitance | V _R = 0 V, f = 1 MHz | | C _O | | 25 | | pF | |
| Thermal resistance | | | R _{thja} | | 1070 | | K/W | |
| OUTPUT | | | | | | | | |
| Collector emitter leakage current | V _{CE} = 10 V | | I _{CEO} | | 10 | 200 | nA | |
| Collector emitter capacitance | V _{CE} = 5 V, f = 1 MHz | | C _{CE} | | 7 | | pF | |
| Thermal resistance | | | R _{thja} | | 500 | | K/W | |
| COUPLER | | | | | | | | |
| Collector emitter saturation voltage | I _C = 0.32 mA, I _F = 1 mA | SFH618A-2 | V _{CEsat} | | 0.25 | 0.4 | V | |
| | | SFH6186-2 | V _{CEsat} | | 0.25 | 0.4 | V | |
| | I _C = 0.5 mA, I _F = 1 mA | SFH618A-3 | V _{CEsat} | | 0.25 | 0.4 | V | |
| | | SFH6186-3 | V _{CEsat} | | 0.25 | 0.4 | V | |
| | I _C = 0.8 mA, I _F = 1 mA | SFH618A-4 | V _{CEsat} | | 0.25 | 0.4 | V | |
| | | SFH6186-4 | V _{CEsat} | | 0.25 | 0.4 | V | |
| | I _C = 1.25 mA, I _F = 1 mA | SFH618A-5 | V _{CEsat} | | 0.25 | 0.4 | V | |
| | | SFH6186-5 | V _{CEsat} | | 0.25 | 0.4 | V | |
| | Coupling capacitance | | | C _C | | 0.25 | | pF |

Note

- Minimum and maximum values are testing requirements. Typical values are characteristics of the device and are the result of engineering evaluation. Typical values are for information only and are not part of the testing requirements.

| CURRENT TRANSFER RATIO (T _{amb} = 25 °C, unless otherwise specified) | | | | | | | |
|---|--|-----------|--------|------|------|------|------|
| PARAMETER | TEST CONDITION | PART | SYMBOL | MIN. | TYP. | MAX. | UNIT |
| I _C /I _F | I _F = 1 mA, V _{CE} = 0.5 V | SFH618A-2 | CTR | 63 | | 125 | % |
| | | SFH6186-2 | CTR | 63 | | 125 | % |
| | I _F = 0.5 mA, V _{CE} = 1.5 V | SFH618A-2 | CTR | 32 | 75 | | % |
| | | SFH6186-2 | CTR | 32 | 75 | | % |
| | I _F = 1 mA, V _{CE} = 0.5 V | SFH618A-3 | CTR | 100 | | 200 | % |
| | | SFH6186-3 | CTR | 100 | | 200 | % |
| | I _F = 0.5 mA, V _{CE} = 1.5 V | SFH618A-3 | CTR | 50 | 120 | | % |
| | | SFH6186-3 | CTR | 50 | 120 | | % |
| | I _F = 1 mA, V _{CE} = 0.5 V | SFH618A-4 | CTR | 160 | | 320 | % |
| | | SFH6186-4 | CTR | 160 | | 320 | % |
| | I _F = 0.5 mA, V _{CE} = 1.5 V | SFH618A-4 | CTR | 80 | 200 | | % |
| | | SFH6186-4 | CTR | 80 | 200 | | % |
| | I _F = 1 mA, V _{CE} = 0.5 V | SFH618A-5 | CTR | 250 | | 500 | % |
| | | SFH6186-5 | CTR | 250 | | 500 | % |
| | I _F = 0.5 mA, V _{CE} = 1.5 V | SFH618A-5 | CTR | 125 | 300 | | % |
| | | SFH6186-5 | CTR | 125 | 300 | | % |

| SWITCHING CHARACTERISTICS (T _{amb} = 25 °C, unless otherwise specified) | | | | | | | |
|--|--|------------------|------|------|------|------|--|
| PARAMETER | TEST CONDITION | SYMBOL | MIN. | TYP. | MAX. | UNIT | |
| Turn on time | V _{CC} = 5 V, I _C = 2 mA, R _L = 100 Ω | t _{on} | | 6 | | μs | |
| Rise time | V _{CC} = 5 V, I _C = 2 mA, R _L = 100 Ω | t _r | | 3.5 | | μs | |
| Turn off time | V _{CC} = 5 V, I _C = 2 mA, R _L = 100 Ω | t _{off} | | 5.5 | | μs | |
| Fall time | V _{CC} = 5 V, I _C = 2 mA, R _L = 100 Ω | t _f | | 5 | | μs | |

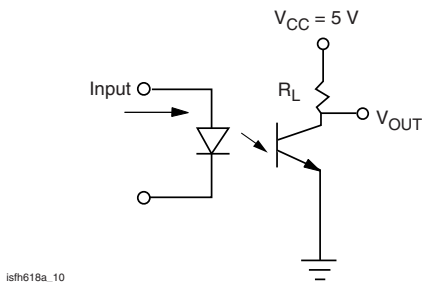

Fig. 2 - Test Circuit

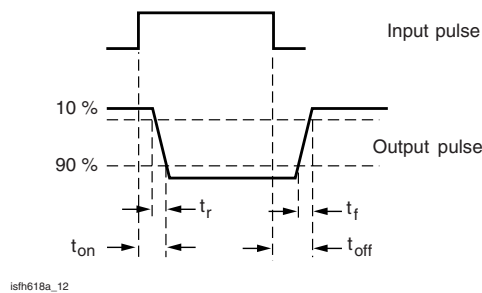

Fig. 3 - Test Circuit and Waveforms

| SAFETY AND INSULATION RATINGS | | | | | | |
|---|-----------------------|--------|-------|-----------|------|------|
| PARAMETER | TEST CONDITION | SYMBOL | MIN. | TYP. | MAX. | UNIT |
| Climatic classification (according to IEC68 part 1) | | | | 55/100/21 | | |
| Comparative tracking index | | CTI | 175 | | 399 | |
| V _{IOTM} | | | 10000 | | | V |
| V _{IORM} | | | 890 | | | V |
| P _{SO} | | | | | 400 | mW |
| I _{SI} | | | | | 275 | mA |
| T _{SI} | | | | | 175 | °C |
| Creepage distance | Standard DIP-4 | | 7 | | | mm |
| Clearance distance | Standard DIP-4 | | 7 | | | mm |
| Creepage distance | 400 mil DIP-4 | | 8 | | | mm |
| Clearance distance | 400 mil DIP-4 | | 8 | | | mm |
| Insulation thickness, reinforced rated | per IEC60950 2.10.5.1 | | 0.4 | | | mm |

Note

- As per IEC60747-5-5, § 7.4.3.8.2, this optocoupler is suitable for “safe electrical insulation” only within the safety ratings. Compliance with the safety ratings shall be ensured by means of protective circuits.

TYPICAL CHARACTERISTICS (T_{amb} = 25 °C, unless otherwise specified)

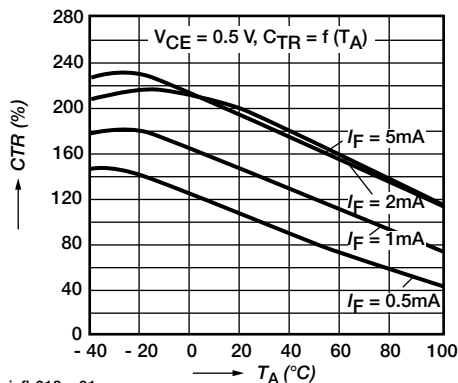

Fig. 4 - Current Transfer Ratio (typ.)

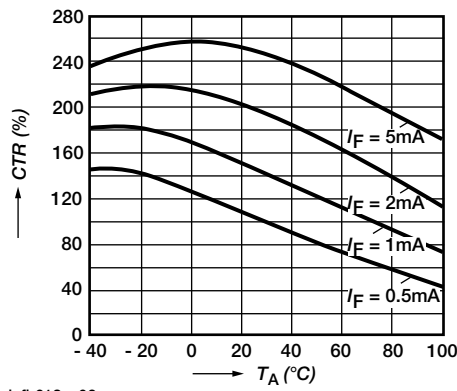

Fig. 5 - Current Transfer Ratio (typ.)

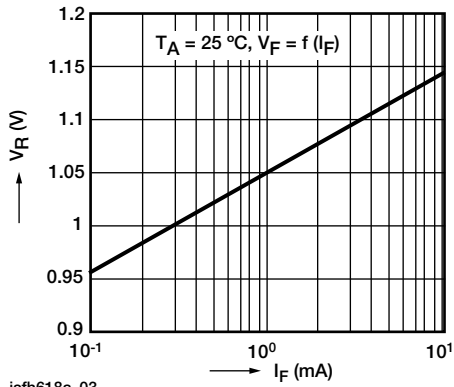

Fig. 6 - Diode Forward Voltage (typ.)

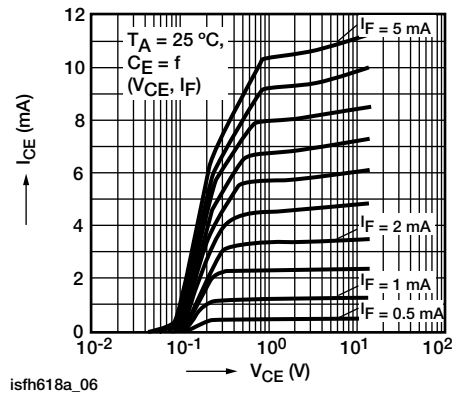

Fig. 9 - Output Characteristics



Fig. 7 - Diode Forward Voltage (typ.)

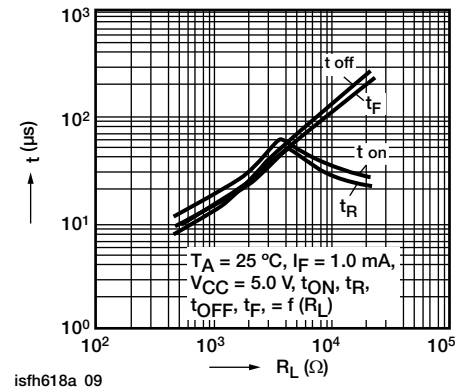

Fig. 10 - Switching Times (typ.)

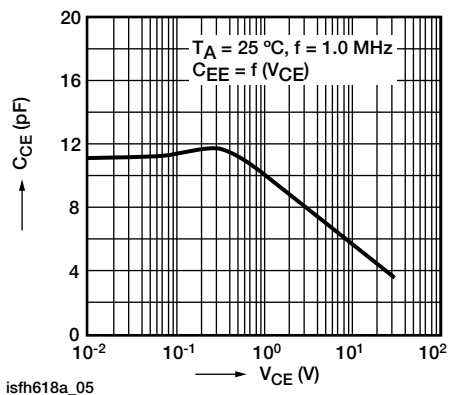
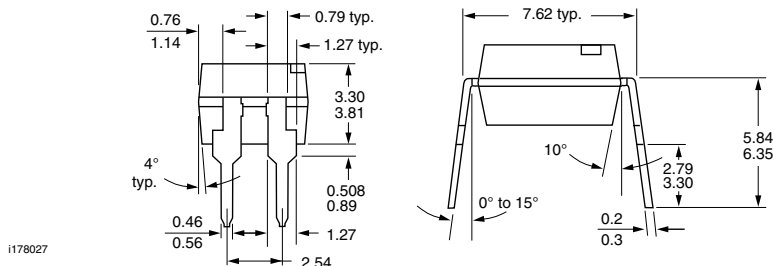
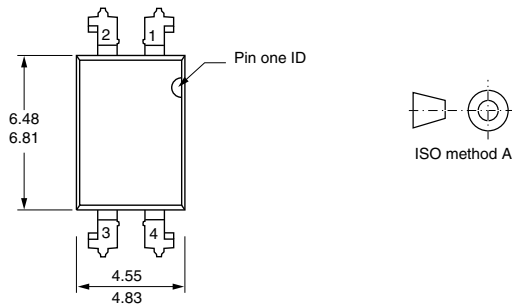

Fig. 8 - Transistor Capacitance



PACKAGE DIMENSIONS in millimeters



i178027

SMD

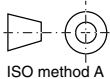
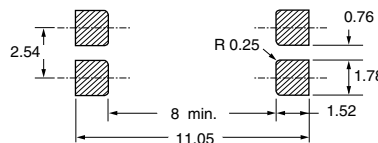
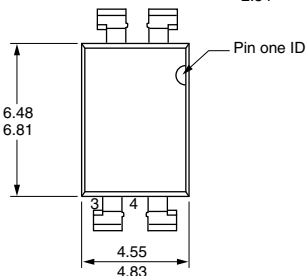

ISO method A

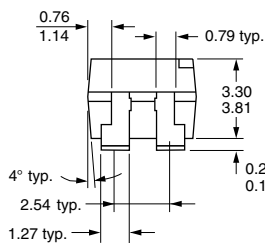

i178029

Lead coplanarity 0.004 max.

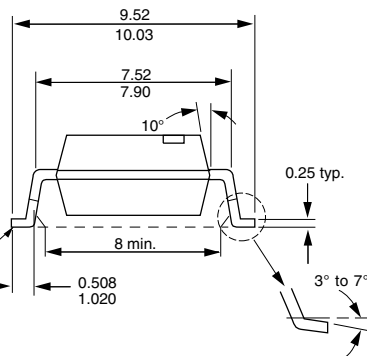

18450-11

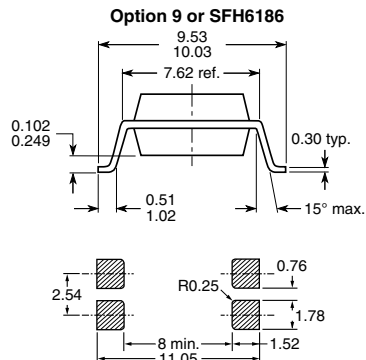
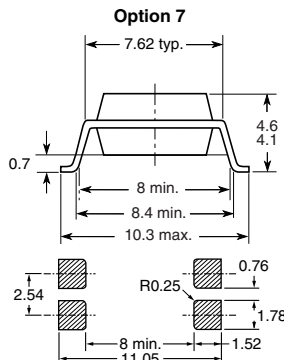

PACKAGE MARKING

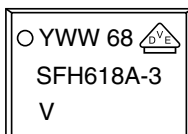



Disclaimer

ALL PRODUCT, PRODUCT SPECIFICATIONS AND DATA ARE SUBJECT TO CHANGE WITHOUT NOTICE TO IMPROVE RELIABILITY, FUNCTION OR DESIGN OR OTHERWISE.

Vishay Intertechnology, Inc., its affiliates, agents, and employees, and all persons acting on its or their behalf (collectively, "Vishay"), disclaim any and all liability for any errors, inaccuracies or incompleteness contained in any datasheet or in any other disclosure relating to any product.

Vishay makes no warranty, representation or guarantee regarding the suitability of the products for any particular purpose or the continuing production of any product. To the maximum extent permitted by applicable law, Vishay disclaims (i) any and all liability arising out of the application or use of any product, (ii) any and all liability, including without limitation special, consequential or incidental damages, and (iii) any and all implied warranties, including warranties of fitness for particular purpose, non-infringement and merchantability.

Statements regarding the suitability of products for certain types of applications are based on Vishay's knowledge of typical requirements that are often placed on Vishay products in generic applications. Such statements are not binding statements about the suitability of products for a particular application. It is the customer's responsibility to validate that a particular product with the properties described in the product specification is suitable for use in a particular application. Parameters provided in datasheets and/or specifications may vary in different applications and performance may vary over time. All operating parameters, including typical parameters, must be validated for each customer application by the customer's technical experts. Product specifications do not expand or otherwise modify Vishay's terms and conditions of purchase, including but not limited to the warranty expressed therein.

Except as expressly indicated in writing, Vishay products are not designed for use in medical, life-saving, or life-sustaining applications or for any other application in which the failure of the Vishay product could result in personal injury or death. Customers using or selling Vishay products not expressly indicated for use in such applications do so at their own risk. Please contact authorized Vishay personnel to obtain written terms and conditions regarding products designed for such applications.

No license, express or implied, by estoppel or otherwise, to any intellectual property rights is granted by this document or by any conduct of Vishay. Product names and markings noted herein may be trademarks of their respective owners.

Material Category Policy

Vishay Intertechnology, Inc. hereby certifies that all its products that are identified as RoHS-Compliant fulfill the definitions and restrictions defined under Directive 2011/65/EU of The European Parliament and of the Council of June 8, 2011 on the restriction of the use of certain hazardous substances in electrical and electronic equipment (EEE) - recast, unless otherwise specified as non-compliant.

Please note that some Vishay documentation may still make reference to RoHS Directive 2002/95/EC. We confirm that all the products identified as being compliant to Directive 2002/95/EC conform to Directive 2011/65/EU.

Vishay Intertechnology, Inc. hereby certifies that all its products that are identified as Halogen-Free follow Halogen-Free requirements as per JEDEC JS709A standards. Please note that some Vishay documentation may still make reference to the IEC 61249-2-21 definition. We confirm that all the products identified as being compliant to IEC 61249-2-21 conform to JEDEC JS709A standards.

Данный компонент на территории Российской Федерации

Вы можете приобрести в компании MosChip.

Для оперативного оформления запроса Вам необходимо перейти по данной ссылке:

<http://moschip.ru/get-element>

Вы можете разместить у нас заказ для любого Вашего проекта, будь то серийное производство или разработка единичного прибора.

В нашем ассортименте представлены ведущие мировые производители активных и пассивных электронных компонентов.

Нашей специализацией является поставка электронной компонентной базы двойного назначения, продукции таких производителей как XILINX, Intel (ex.ALTERA), Vicor, Microchip, Texas Instruments, Analog Devices, Mini-Circuits, Amphenol, Glenair.

Сотрудничество с глобальными дистрибьюторами электронных компонентов, предоставляет возможность заказывать и получать с международных складов практически любой перечень компонентов в оптимальные для Вас сроки.

На всех этапах разработки и производства наши партнеры могут получить квалифицированную поддержку опытных инженеров.

Система менеджмента качества компании отвечает требованиям в соответствии с ГОСТ Р ИСО 9001, ГОСТ РВ 0015-002 и ЭС РД 009

Офис по работе с юридическими лицами:

105318, г.Москва, ул.Щербаковская д.3, офис 1107, 1118, ДЦ «Щербаковский»

Телефон: +7 495 668-12-70 (многоканальный)

Факс: +7 495 668-12-70 (доб.304)

E-mail: info@moschip.ru

Skype отдела продаж:

moschip.ru

moschip.ru_4

moschip.ru_6

moschip.ru_9