

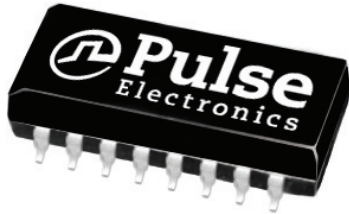





Copperhead™ High Speed Dual Transformers



-  Compliant with ANSI X3T111, Fiber Channel, FC-PH-3 for quarter/full speed applications, SMPTE, IEEE1394 Firewire
-  Moisture sensitivity Level 3
-  Pick and place compatible
-  Peak temperature profile 250°C; NL parts peak temperature is 245°C.
-  AS9100 Certified (Based on and including ISO 9001:2000)

Electrical Specifications @ 25°C - Operating Temperature -55°C to +125°C

Part Number	Turns Ratio (±5%)	Primary Inductance (µH MIN)	Rise Time @ 20 & 80% (pS MAX)	DC Resistance (ΩMAX)	Hi-Pot (Vrms MIN)	Insertion Loss (dB MAX)	Application Nominal Bit Rate (Mbaud)
T-330SCT	1CT : 1CT	26 @ 1 Vrms, 100kHz	350	0.2	1,500	-1.5 @ 15-165MHz	265.6 (1/4 speed)
T-531SCT	1CT : 1CT	7.5 @ 1 Vrms, 100kHz	325	0.2	1,500	-2.0 @ 50-265MHz	531 (half speed)
T-1062SCT	1CT : 1CT	3.75 @ 1 Vrms, 100kHz	280	0.2	1,500	-2.0 @ 100-531MHz	1,062.5 (full speed)
T-1250SCT	1CT : 1CT	3.75 @ 1 Vrms, 100kHz	280	0.2	1,500	-2.0 @ 125-650MHz	1,250
T-1485SCT	1CT : 1CT	3.75 @ 1 Vrms, 100kHz	280	0.2	1,500	-2.0	1,485 (SMTPE)
T-3200SCT	1 : 1	0.70	200	0.2	1,500	-4.5	3,200

Notes:

- To order a RoHS compliant part, add the suffix "NL" to the part number, i.e. T-330SCT becomes T-330SCTNL.
- Add suffix "T" to part number for Tape & Reel package (i.e. T-330SCTT).

Mechanical

Schematic

T-330SCT, T-531SCT, T-1062SCT, T1250SCT and T-1485SCT

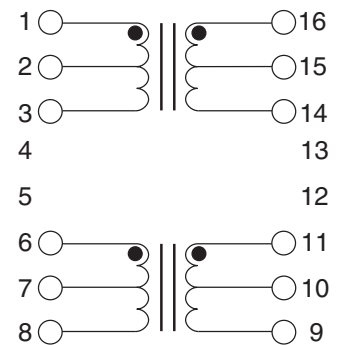
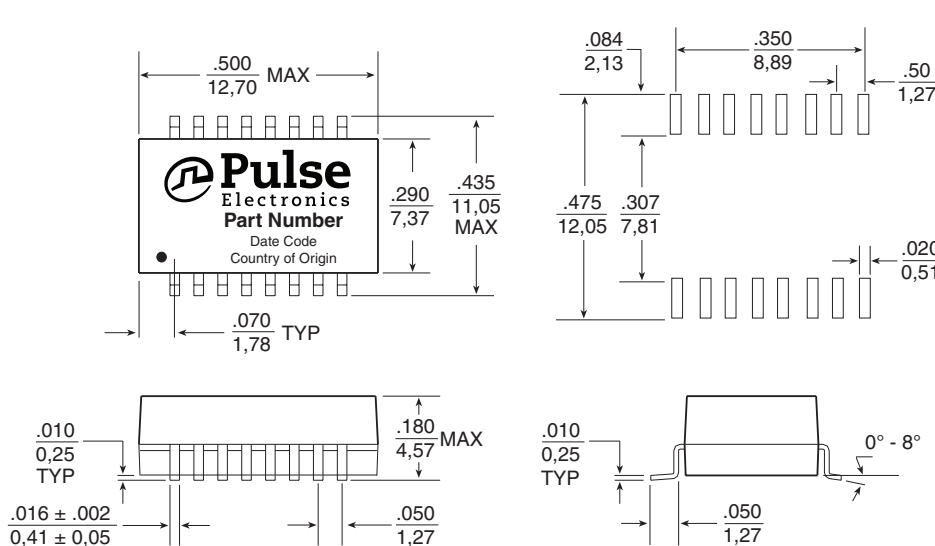

Weight 1.0 grams
 Tape & Reel 400/reel
 Dimensions: $\frac{\text{Inches}}{\text{mm}}$
 Unless otherwise specified,
 all tolerances are $\pm \frac{.005}{0,13}$

Copperhead™ High Speed Dual Transformers

Mechanical

Schematic

T-3200SCT

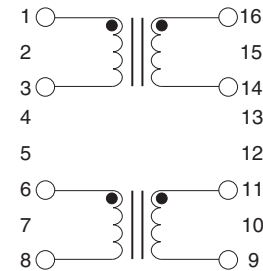
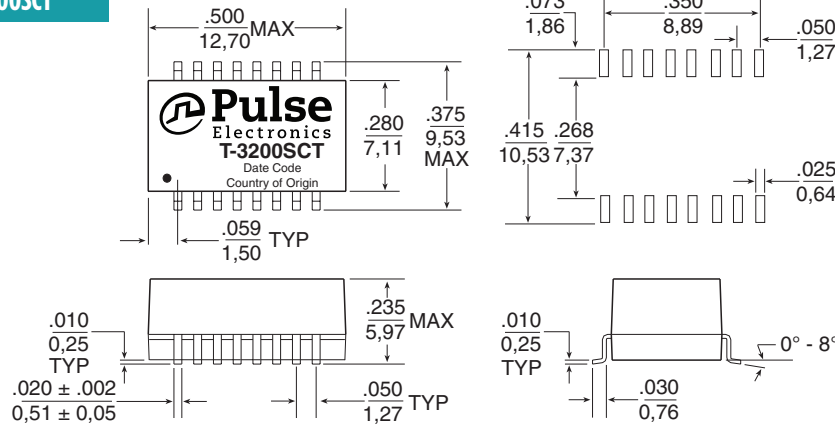

Weight 1.0 grams
 Tape & Reel 600/reel
 Dimensions: Inches
 mm
 Unless otherwise specified,
 all tolerances are $\pm \frac{.005}{0.13}$

Application

Pulse Specialty Components has designed Fibre Channel dual transformers specifically for point to point coupling to 150 twinax cable. The isolation transformers protect the station from static charges that may develop on the cable, and prevents ground loop currents from being transferred between stations. The devices have also been designed to provide common mode rejection within the transmission band and thus reduce EMI. The wide bandwidth of these

devices minimizes data dependent jitter by providing fast signal rise times. Low-end bandwidth also minimizes base-line wander, another contributor to jitter. The dual package allows connection of both transmit and receive channels, as shown in the application circuit below. Surface-mount packaging also allows a cost-effective solution.

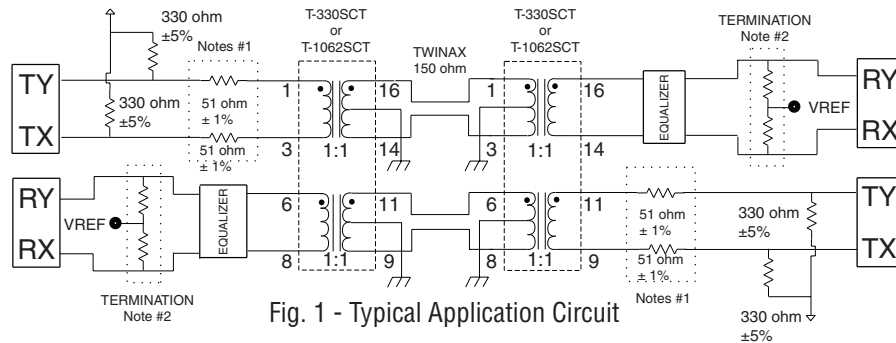

Fig. 1 - Typical Application Circuit

1. The transformer, 51 Ω resistors, and the impedance of the driver are matched to achieve the best return loss (S11) for the transmitter of the 150 Ω system.
2. The total impedance of termination resistor network is 150 Ω .
3. When laying out PCB, transmission line methods must be utilized to maintain return loss and signal integrity. Transformer must be located within .50 of the DB9

4. It is recommended that the center tap (CT) of transformer(s), cable side, be connected to earth/chassis (cable shield) ground either directly or via a transient voltage suppressor (TVS) type component and earth/chassis ground should be "AC-coupled" to signal (digital) ground through a 0.27uF, 500v capacitor.

For More Information

Pulse Worldwide Headquarters
 12220 World Trade Drive
 San Diego, CA
 92128
 U.S.A.

Pulse Europe
 Einsteinstrasse 1
 D-71083 Herrenberg
 Germany

Pulse China Headquarters
 B402, Shenzhen Academy of
 Aerospace Technology Bldg.
 10th Kejinan Road
 High-Tech Zone
 Nanshan District
 Shenzhen, PR China
 518057

Pulse North China
 Room 2704/2705
 Super Ocean Finance
 Ctr.
 2067 Yan An Road
 West
 Shanghai 200336
 China

Pulse South Asia
 135 Joo Seng Road
 #03-02
 PM Industrial Bldg.
 Singapore 368363

Pulse North Asia
 3F, No. 198
 Zhongyuan Road
 Zhongli City
 Taoyuan County 320
 Taiwan R. O. C.
 Tel: 886 3 4356768
 Fax: 886 3 4356823
 (Pulse)

Tel: 858 674 8100

Tel: 49 7032 7806

Tel: 65 6287 8998
 Fax: 65 6287 8998

Performance warranty of products offered on this data sheet is limited to the parameters specified. Data is subject to change without notice. Other brand and product names mentioned herein may be trademarks or registered trademarks of their respective owners. © Copyright, 2014. Pulse Electronics, Inc. All rights reserved.

Данный компонент на территории Российской Федерации

Вы можете приобрести в компании MosChip.

Для оперативного оформления запроса Вам необходимо перейти по данной ссылке:

<http://moschip.ru/get-element>

Вы можете разместить у нас заказ для любого Вашего проекта, будь то серийное производство или разработка единичного прибора.

В нашем ассортименте представлены ведущие мировые производители активных и пассивных электронных компонентов.

Нашей специализацией является поставка электронной компонентной базы двойного назначения, продукции таких производителей как XILINX, Intel (ex.ALTERA), Vicor, Microchip, Texas Instruments, Analog Devices, Mini-Circuits, Amphenol, Glenair.

Сотрудничество с глобальными дистрибьюторами электронных компонентов, предоставляет возможность заказывать и получать с международных складов практически любой перечень компонентов в оптимальные для Вас сроки.

На всех этапах разработки и производства наши партнеры могут получить квалифицированную поддержку опытных инженеров.

Система менеджмента качества компании отвечает требованиям в соответствии с ГОСТ Р ИСО 9001, ГОСТ РВ 0015-002 и ЭС РД 009

Офис по работе с юридическими лицами:

105318, г.Москва, ул.Щербаковская д.3, офис 1107, 1118, ДЦ «Щербаковский»

Телефон: +7 495 668-12-70 (многоканальный)

Факс: +7 495 668-12-70 (доб.304)

E-mail: info@moschip.ru

Skype отдела продаж:

moschip.ru

moschip.ru_4

moschip.ru_6

moschip.ru_9