

# COMPACT POWER TWIN RELAY

## 1POLE X 2, H-BRIDGE— 25 A FOR AUTOMOTIVE APPLICATIONS

### FTR-P4 Series

**RoHS compliant**

#### ■ FEATURES

- Compact for high density packaging.  
(60% volume of previous generation FBR512).
- High contact capacity with proven contact material.  
(100,000 operations, 14 V, 25 A achieved, even with reduced size).
- Coil power savings  
(600mW nominal achieved with state-of-the-art magnetic analysis/design).
- 125°C version is available.
- Ease of PCB layout  
(all terminals on perimeter, coil and contact terminals separated).
- Pin compatible with low acoustic noise relay, FTR-P2.
- Optional over-voltage circuit breaking capability  
(0.6mm gap, contact our representative).
- Packaging for auto-insertion  
(tube packing, 30 relays/tube).
- RoHS compliant since date code: 0624  
Please see page 8 for more information



#### ■ ORDERING INFORMATION

FTR-P4   C   N   012   W1   \*\*\*  
[Example]   (a)   (b)   (c)   (d)   (e)   (f)

(a)	Series Name	FTR-P4 Series
(b)	Contact Arrangement	C : 1 Form C x 2 (H-Bridge)
(c)	Contact Gap	N : 0.3mm gap P : 0.6mm gap
(d)	Nominal Coil Voltage	009 : 9VDC 010 : 10VDC 012 : 12VDC
(e)	Contact Material	W1 : Silver-tin oxide-indium
(f)	Custom Designation	Nil : Standard (85°C) -01 : High temperature (125°C)

Note: The part number stamped on the relay cover does not include "FTR".  
 Example: Ordering part number: FTR-P4CN012W1  
 Stamped on part number: P4CN012W1

#### ■ TYPICAL APPLICATIONS

Power window	Power seat	Tilt steering
Door lock	Sun roof	Retractable antenna

# FTR-P4 SERIES

## ■ SPECIFICATIONS

Item		Specification		
		Standard	High Temperature version	
Contact	Arrangement	1 form C x 2 (H-Bridge)		
	Material	Silver-tin oxide-indium		
	Voltage Drop (Resistance)	Maximum 100 mV (at 1 A 12 VDC)		
	Rating	25 A at 14 VDC (locked motor load)		
	Maximum Carrying Current	25 A / 1 hour (20° C, 100% rated coil voltage)		
	Maximum Inrush Current (Reference)	35 A		
	Maximum Switching Current (Reference)	35 A at 16 VDC		
	Minimum Switching Load*1 (Reference)	1 A, 6 VDC		
Coil	Operating Temperature Range	-40° C to +85° C (no frost)	-40° C to +125° C (no frost)	
	Storage Temperature Range	-40° C to +100° C (no frost)	-40° C to +125° C (no frost)	
Timing Values	Operate (at nominal voltage)	Maximum 10ms (not including bounce)		
	Release (at nominal voltage)	Maximum 5ms (not including bounce, no diode) Maximum 15ms (not including bounce, with diode)		
Life	Mechanical	10 x 10 <sup>6</sup> operations minimum		
	Electrical	100 x 10 <sup>3</sup> operations minimum 14 VDC, 25 A (locked motor load) (1 operation = 1 forward, 1 reverse)		
Other	Vibration Resistance	Operational	10-55Hz, 1.5mm double amplitude (=9.13G @ 55Hz) 55-100Hz, 45m/sec <sup>2</sup> (4.6G)	
		Shock Resistance	Operational	100 m/s <sup>2</sup> minimum (10G)
		Endurance	1, 000 m/s <sup>2</sup> minimum (100G)	
	Insulation Resistance (initial)		100M ohms @500 VAC	
	Dielectric Withstanding Voltage (initial)		500 VAC	
	Weight		Approximately 9.0g	

\*1 Values when switching a resistive load at normal room temperature and humidity and in a clean environment. The minimum switching load varies with the switching frequency and operating environment.

# FTR-P4 SERIES

## ■ COIL DATA CHART

### FTR-P4 Series (0.25mm contact gap)

Model	Nominal Coil Voltage	Coil Resistance (±10% at 20°C)	Must Operate Voltage	Must Release Voltage (at 20°C)	Coil Power at Nominal Voltage	Thermal Resistance (approx.)
FTR-P4-CN009W1 ( )	9VDC	135Ω	5.5VDC (at 20°C) 6.9VDC (at 85°C)	0.75VDC	0.6W	73°C/W
FTR-P4-CN010W1 ( )	10VDC	167Ω	6.3VDC (at 20°C) 7.9VDC (at 85°C)	0.9VDC	0.6W	73°C/W
FTR-P4-CN012W1 ( )	12VDC	240Ω	7.3VDC (at 20°C) 9.2VDC (at 85°C)	1.0VDC	0.6W	73°C/W

Note: ( ) is "Nil" or "-01"

### FTR-P4 Series (0.6mm contact gap)

Model	Nominal Coil Voltage	Coil Resistance (±10% at 20°C)	Must Operate Voltage	Must Release Voltage (at 20°C)	Coil Power at Nominal Voltage	Thermal Resistance (approx.)
FTR-P4-CP009W1	9VDC	100Ω	5.5VDC (at 20°C) 6.9VDC (at 85°C)	0.75VDC	0.8W	73°C/W
FTR-P4-CP010W1	10VDC	125Ω	6.3VDC (at 20°C) 7.9VDC (at 85°C)	0.9VDC	0.8W	73°C/W
FTR-P4-CP012W1	12VDC	167Ω	7.3VDC (at 20°C) 9.2VDC (at 85°C)	1.0VDC	0.8W	73°C/W

## CHARACTERISTIC DATA

### 1. LIFE TEST (EXAMPLES)

- Test item  
14 V DC-25 A  
locked motor  
100K operations\* minimum  
0.25 seconds ON,  
9.75 seconds OFF

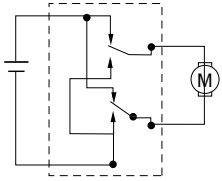

- Change of operate and release voltage

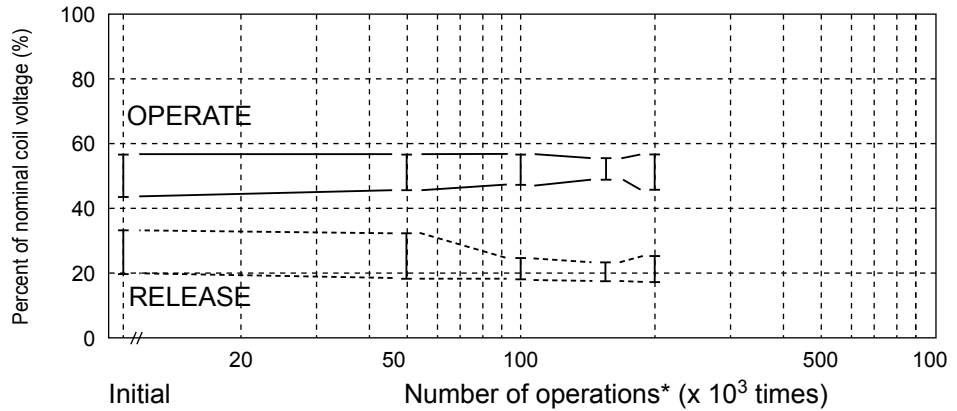

- Current wave form

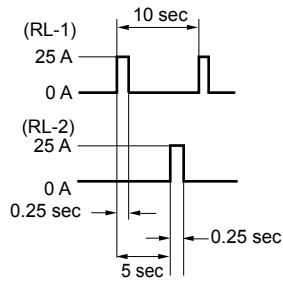

\* 1 operation = 1 forward and 1 reverse

- Change in contact resistance

(Measured at 6 VDC, 1A wet)

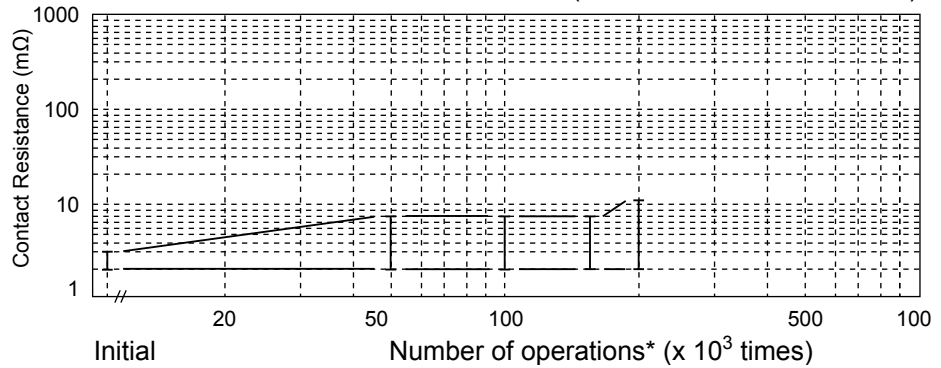

## 2. MAXIMUM BREAK CAPACITY

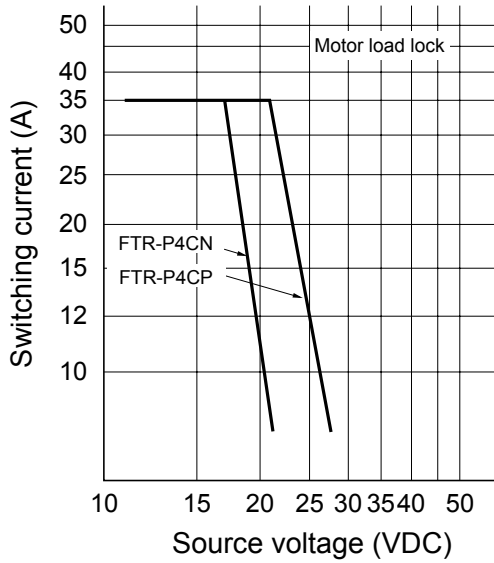

## 3. COIL TEMPERATURE RISE

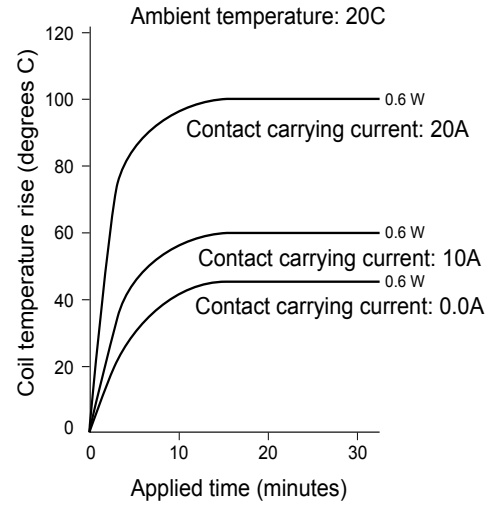

## 4. OPERATING COIL VOLTAGE RANGE

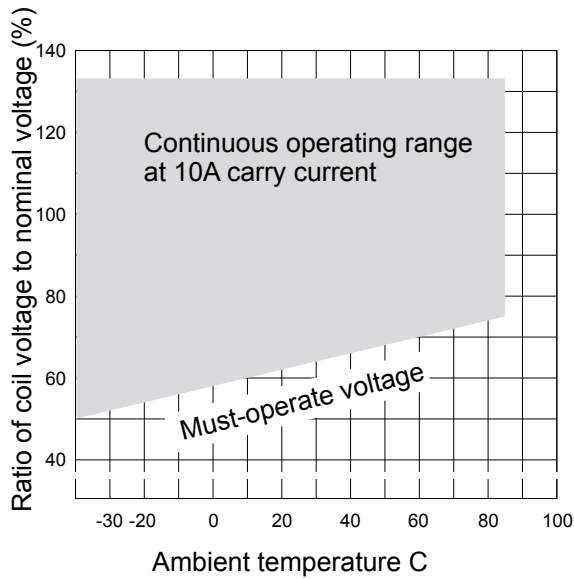

## 5. VIBRATION RESISTANCE CHARACTERISTIC

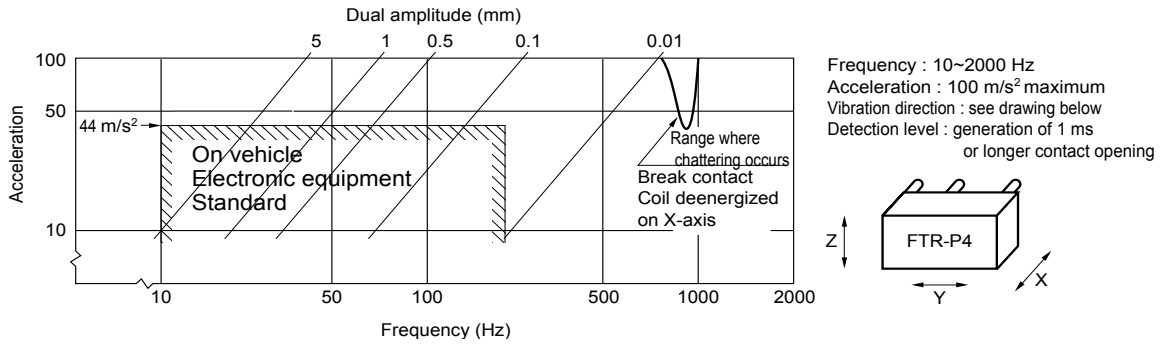

## 6. SHOCK RESISTANCE CHARACTERISTIC

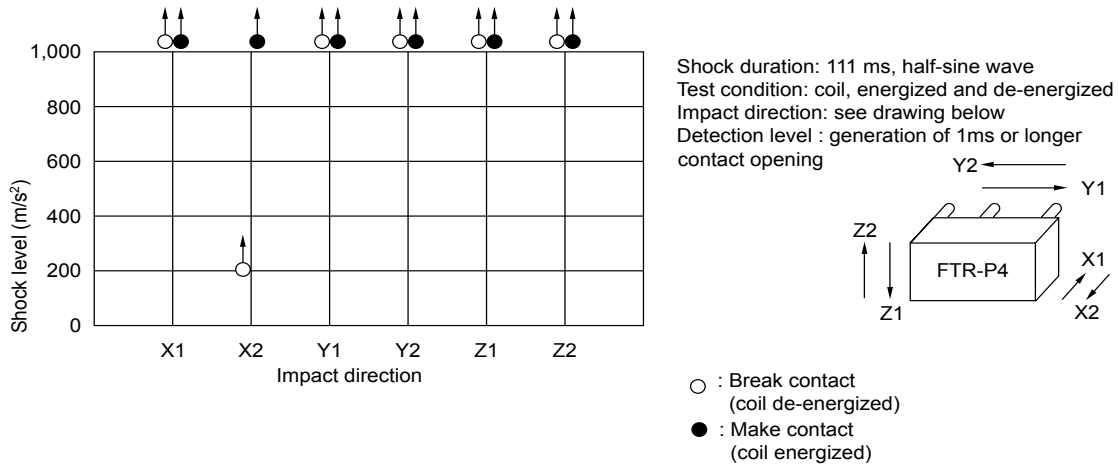

## ■ REFERENCE DATA

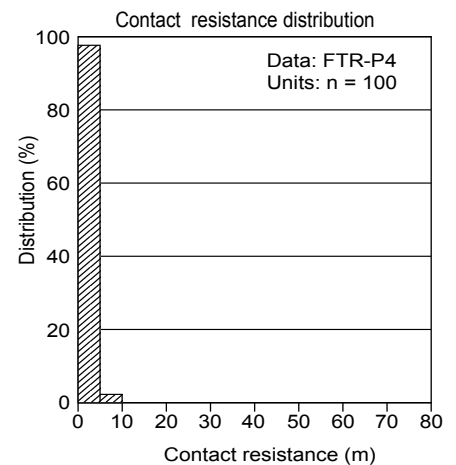
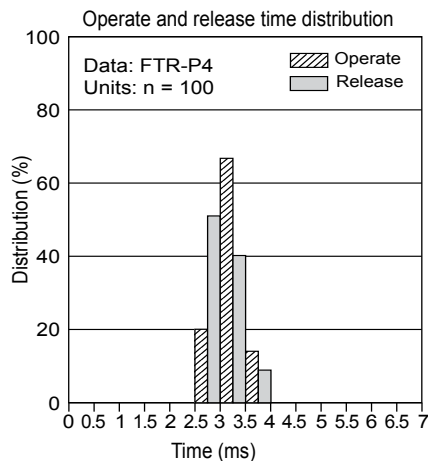
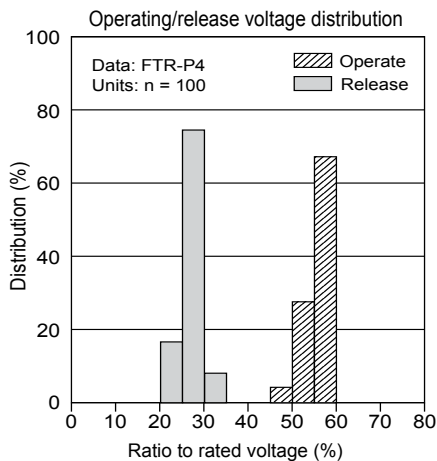

## ■ DIMENSIONS AND SCHEMATICS

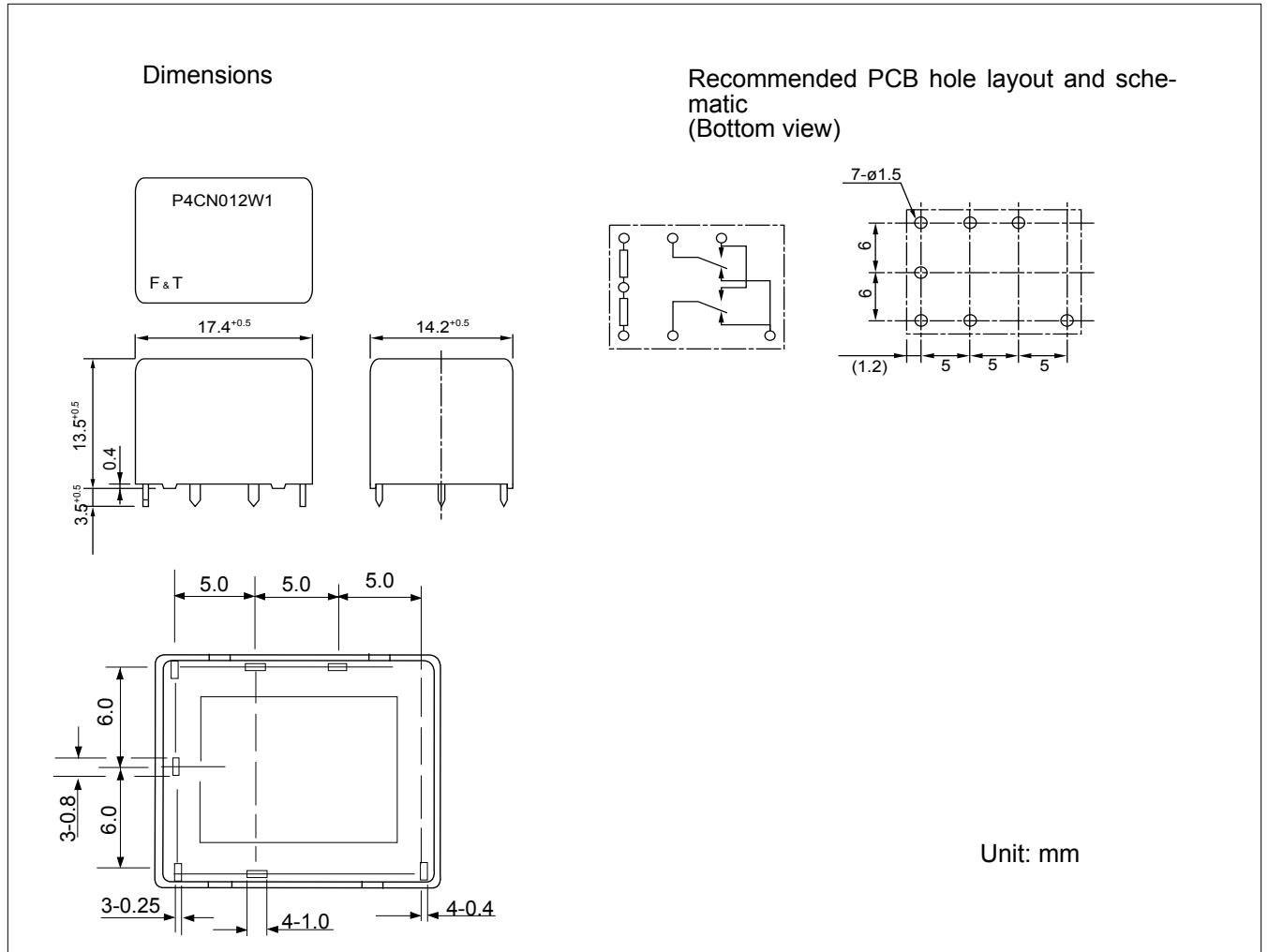

## ■ PRECAUTIONS

Please refer to the Engineering Reference in our relay databook for general precautions.

## RoHS Compliance and Lead Free Relay Information

### 1. General Information

- Relays produced after the specific date code that is indicated on each data sheet are lead-free now. Most of our signal and power relays are lead-free. Please refer to Lead-Free Status Info. (<http://www.fujitsu.com/us/downloads/MICRO/fcai/relays/lead-free-letter.pdf>)
- Lead free solder paste currently used in relays is Sn-3.0Ag-0.5Cu.
- All signal and most power relays also comply with RoHS. Please refer to individual data sheets. Relays that are RoHS compliant do not contain the 5 hazardous materials that are restricted by RoHS directive (lead, mercury, chromium IV, PBB, PBDE).
- It has been verified that using lead-free relays in leaded assembly process will not cause any problems (compatible).
- "LF" is marked on each outer and inner carton. (No marking on individual relays).
- To avoid leaded relays (for lead-free sample, etc.) please consult with area sales office.
- We will ship leaded relays as long as the leaded relay inventory exists.

Note: Cadmium was exempted from RoHS on October 21, 2005. (Amendment to Directive 2002/95/EC)

### 2. Recommended Lead Free Solder Profile

- Recommended solder paste Sn-3.0Ag-0.5Cu.

#### Reflow Solder condition

**Flow Solder condition:**

Pre-heating: maximum 120°C  
Soldering: dip within 5 sec. at  
260°C solder bath

**Solder by Soldering Iron:**

Soldering Iron  
Temperature: maximum 360°C  
Duration: maximum 3 sec.

**We highly recommend that you confirm your actual solder conditions**

### 3. Moisture Sensitivity

- Moisture Sensitivity Level standard is not applicable to electromechanical relays.

### 4. Tin Whisker

- Dipped SnAgCu solder is known as low risk tin whisker. No considerable length whisker was found by our in house test.



## Fujitsu Components International Headquarter Offices

### Japan

Fujitsu Component Limited  
Gotanda-Chuo Building  
3-5, Higashigotanda 2-chome, Shinagawa-ku  
Tokyo 141 8630, Japan  
Tel: (81-3) 5449-7010  
Fax: (81-3) 5449-2626  
Email: [promothq@fcl.fujitsu.com](mailto:promothq@fcl.fujitsu.com)  
Web: [www.fcl.fujitsu.com](http://www.fcl.fujitsu.com)

### North and South America

Fujitsu Components America, Inc.  
250 E. Caribbean Drive  
Sunnyvale, CA 94089 U.S.A.  
Tel: (1-408) 745-4900  
Fax: (1-408) 745-4970  
Email: [components@us.fujitsu.com](mailto:components@us.fujitsu.com)  
Web: <http://www.fujitsu.com/us/services/edevices/components/>

### Europe

Fujitsu Components Europe B.V.  
Diamantlaan 25  
2132 WV Hoofddorp  
Netherlands  
Tel: (31-23) 5560910  
Fax: (31-23) 5560950  
Email: [info@fceu.fujitsu.com](mailto:info@fceu.fujitsu.com)  
Web: [emea.fujitsu.com/components/](http://emea.fujitsu.com/components/)

### Asia Pacific

Fujitsu Components Asia Ltd.  
102E Pasir Panjang Road  
#01-01 Citilink Warehouse Complex  
Singapore 118529  
Tel: (65) 6375-8560  
Fax: (65) 6273-3021  
Email: [fcal@fcal.fujitsu.com](mailto:fcal@fcal.fujitsu.com)  
Web: <http://www.fujitsu.com/sg/services/micro/components/>

©2009 Fujitsu Components America, Inc. All rights reserved. All trademarks or registered trademarks are the property of their respective owners.

Fujitsu Components America or its affiliates do not warrant that the content of datasheet is error free. In a continuing effort to improve our products Fujitsu Components America, Inc. or its affiliates reserve the right to change specifications/datasheets without prior notice.  
Rev. March 4, 2009.

## Данный компонент на территории Российской Федерации

### Вы можете приобрести в компании MosChip.

Для оперативного оформления запроса Вам необходимо перейти по данной ссылке:

<http://moschip.ru/get-element>

Вы можете разместить у нас заказ для любого Вашего проекта, будь то серийное производство или разработка единичного прибора.

В нашем ассортименте представлены ведущие мировые производители активных и пассивных электронных компонентов.

Нашей специализацией является поставка электронной компонентной базы двойного назначения, продукции таких производителей как XILINX, Intel (ex.ALTERA), Vicor, Microchip, Texas Instruments, Analog Devices, Mini-Circuits, Amphenol, Glenair.

Сотрудничество с глобальными дистрибьюторами электронных компонентов, предоставляет возможность заказывать и получать с международных складов практически любой перечень компонентов в оптимальные для Вас сроки.

На всех этапах разработки и производства наши партнеры могут получить квалифицированную поддержку опытных инженеров.

Система менеджмента качества компании отвечает требованиям в соответствии с ГОСТ Р ИСО 9001, ГОСТ РВ 0015-002 и ЭС РД 009

### Офис по работе с юридическими лицами:

105318, г.Москва, ул.Щербаковская д.3, офис 1107, 1118, ДЦ «Щербаковский»

Телефон: +7 495 668-12-70 (многоканальный)

Факс: +7 495 668-12-70 (доб.304)

E-mail: [info@moschip.ru](mailto:info@moschip.ru)

Skype отдела продаж:

moschip.ru

moschip.ru\_4

moschip.ru\_6

moschip.ru\_9