

## 2.495V Programmable Shunt Voltage Reference

### DESCRIPTION

TS431 integrated circuits are three-terminal programmable shunt regulator diodes. These monolithic IC voltage references operate as a low temperature coefficient zener which is programmable from  $V_{REF}$  to 36V with two external resistors. These devices exhibit a wide operating current range to 250mA with a typical dynamic impedance of  $0.2\Omega$ . The characteristics of these references make them excellent replacements for zener diodes in many applications such as digital voltmeters, power supplies, and op amp circuitry. The 2.495V reference makes it convenient to obtain a stable reference from 5.0V logic supplies, and since The TS431 operates as a shunt regulator, it can be used as either a positive or negative stage reference.

### FEATURES

- Programmable Output Voltage up to 36V
  - TS431A –  $V_{REF}$  2.495V  $\pm 1\%$  tolerance
  - TS431B –  $V_{REF}$  2.495V  $\pm 0.5\%$  tolerance
- Fast Turn-On Response
- Sink Current Capability: 120mA
- Low Dynamic Output Impedance:  $0.2\Omega$  (Typ.)
- Min. Operating Cathode Current: 0.2mA (Typ.)
- Compliant to RoHS Directive 2011/65/EU and in accordance to WEEE 2002/96/EC
- Halogen-free according to IEC 61249-2-21

### APPLICATION

- SMPS
- Lighting
- Telecommunication
- Home appliance



**SOT-23**

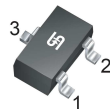

**Pin Definition:**

1. Cathode
2. Reference
3. Anode

**Notes:** MSL 3 (Moisture Sensitivity Level) per J-STD-020

### SIMPLIFIED SCHEMATIC

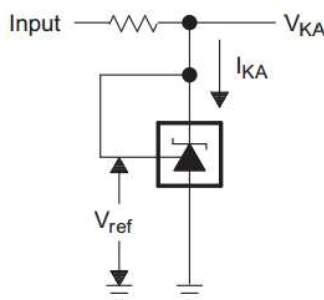

**ABSOLUTE MAXIMUM RATINGS** ( $T_A = 25^\circ\text{C}$  unless otherwise noted)

PARAMETER	SYMBOL	LIMIT	UNIT
Cathode Voltage	$V_{KA}$	36	V
Continuous Cathode Current	$I_K$	120	mA
Reference Input Current	$I_{REF}$	10	mA
Power Dissipation	$P_D$	0.25	W
Operating Temperature Range	$T_{OPER}$	-40 ~ +125	$^\circ\text{C}$
Junction Temperature	$T_J$	+150	$^\circ\text{C}$
Storage Temperature Range	$T_{STG}$	-40 ~ +150	$^\circ\text{C}$

**THERMAL PERFORMANCE**

PARAMETER	SYMBOL	LIMIT	UNIT
Thermal Resistance - Junction to Case	$R_{\theta JC}$	110	$^\circ\text{C/W}$
Thermal Resistance - Junction to Ambient	$R_{\theta JA}$	350	$^\circ\text{C/W}$

**Note:** Consider measured with the PCB copper area of approximately 1 in<sup>2</sup> (Multi-Layer)

**ELECTRICAL SPECIFICATIONS** ( $T_A = +25^\circ\text{C}$ , unless otherwise specified)

PARAMETER	SYMBOL	CONDITIONS	MIN	TYP	MAX	UNIT	
Reference voltage	$V_{REF}$	$V_{KA} = V_{REF}, I_K = 10\text{mA}$ (Figure 1)	TS431A	2.470	2.495	2.520	V
			TS431B	2.483		2.507	
Deviation of reference input voltage	$\Delta V_{REF}$	$V_{KA} = V_{REF}, I_K = 10\text{mA}$ (Figure 1) $T_A = -20 \sim 85^\circ\text{C}$	--	25	35	mV	
Radio of change in Vref to change in cathode Voltage	$\frac{\Delta V_{REF}}{\Delta V_{KA}}$	$I_{KA} = 10\text{mA}$ , (Figure 2)	$V_{KA} = 10\text{V to } V_{REF}$	--	-1.2	-2.0	mV/V
			$V_{KA} = 36\text{V to } 10\text{V}$	--	-1.0	-2.0	
Reference Input current	$I_{REF}$	$R1 = 10\text{k}\Omega, R2 = \infty$ $I_{KA} = 10\text{mA}$ (Figure 2)	--	1.5	3.5	$\mu\text{A}$	
Deviation of reference input current, over temp.	$\Delta I_{REF}$	$R1 = 10\text{k}\Omega, R2 = \infty, I_{KA} = 10\text{mA}$ $T_A = -20 \sim 85^\circ\text{C}$ (Figure 2)	--	0.4	1.2	$\mu\text{A}$	
Off-state Cathode Current	$I_{KA}(\text{off})$	$V_{REF} = 0\text{V}$ (Figure 3), $V_{KA} = 36\text{V}$	--	0.1	1.0	$\mu\text{A}$	
Dynamic Output Impedance	$ Z_{KA} $	$f < 1\text{kHz}, V_{KA} = V_{REF}$ (Figure 1)	--	0.2	0.5	$\Omega$	
Minimum operating cathode current	$I_{KA}(\text{min})$	$V_{KA} = V_{REF}$ (Figure 1)	--	0.2	0.5	mA	

**Note:** The deviation parameters  $\Delta V_{REF}$  and  $\Delta I_{REF}$  are defined as difference between the maximum value and minimum value obtained over the full operating ambient temperature range that applied.

**ORDERING INFORMATION**

PART NO.	PACKAGE	PACKING
TS431ARIX-Z RFG	SOT-23	3,000pcs / 7" Reel
TS431BRIX-Z RFG	SOT-23	3,000pcs / 7" Reel

**CHARACTERISTICS CURVES**

( $T_C = 25^\circ\text{C}$  unless otherwise noted)

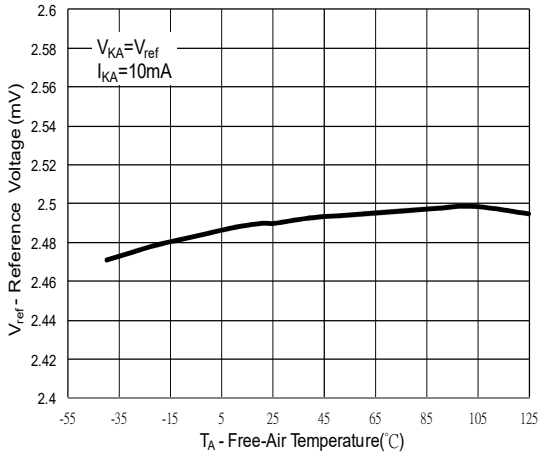

**Figure 1.  $V_{REF}$  vs. Ambient Temperature**

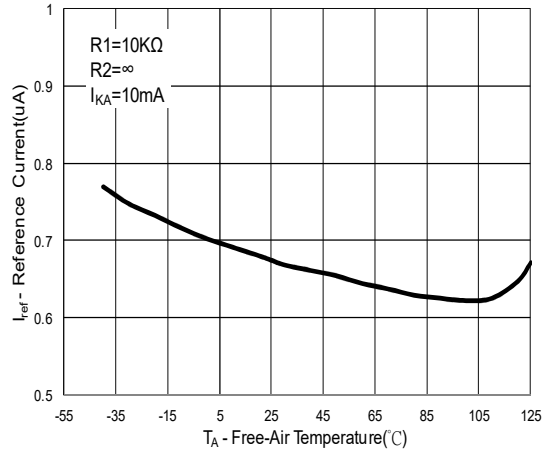

**Figure 2.  $I_{REF}$  vs. Ambient Temperature**

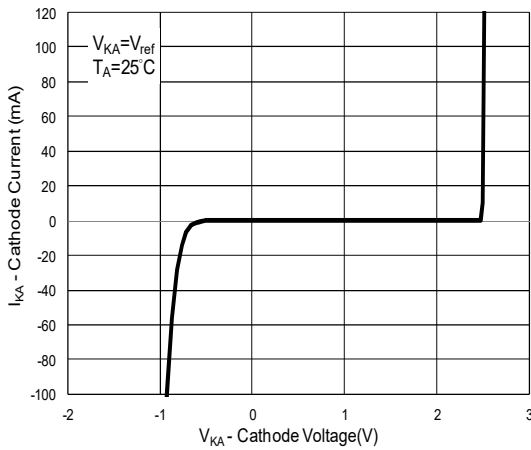

**Figure 3. Cathode Current vs. Cathode Voltage**

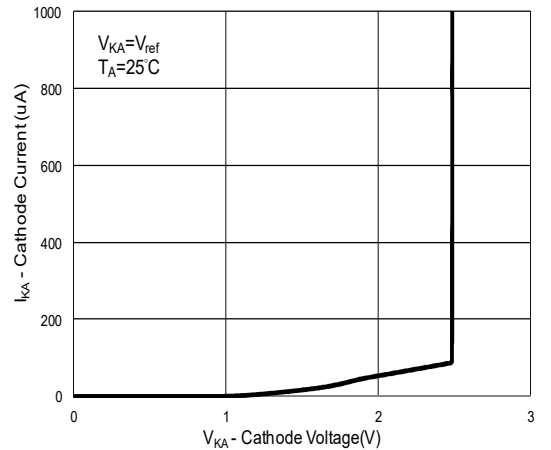

**Figure 4. Cathode Current vs. Cathode Voltage**

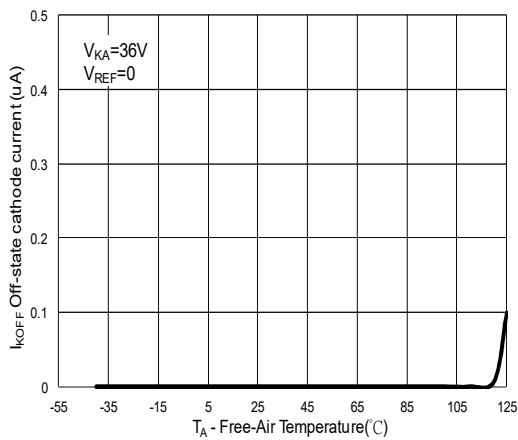

**Figure 5. Off-State Cathode current vs. Ambient Temperature**

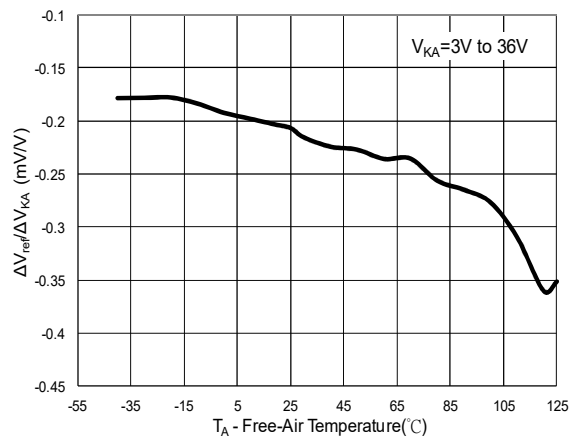

**Figure 6. Ratio of delta reference voltage to delta cathode voltage vs. Ambient Temperature**

**TYPICAL PERFORMANCE CHARACTERISTICS**

**Small-Signal Voltage Gain and Phase Shift vs. Frequency**

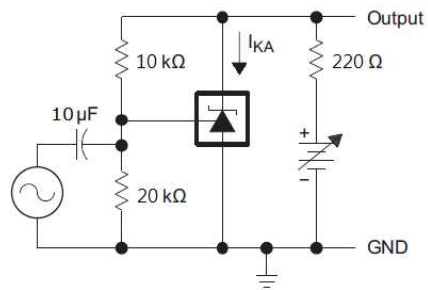
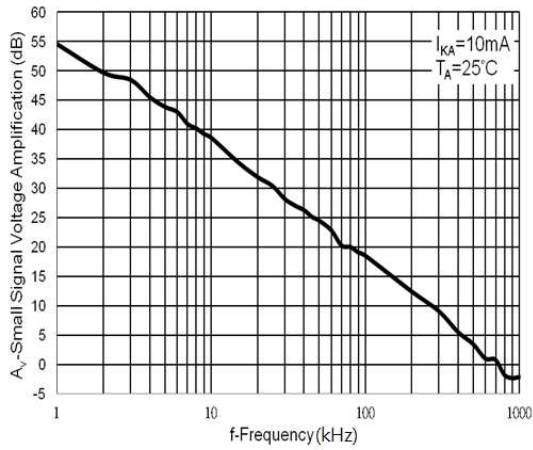

Test Circuit For Voltage Amplification

**Reference Impedance vs. Frequency**

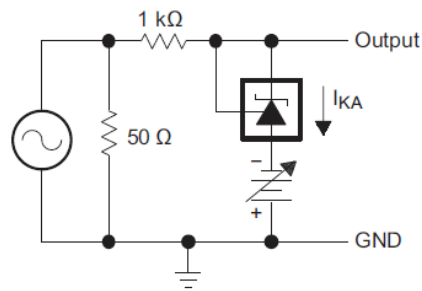
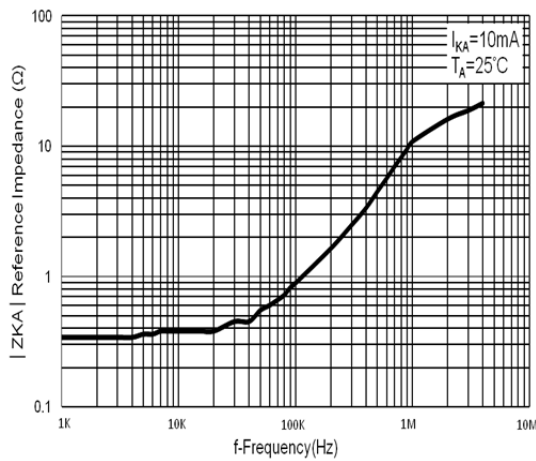

Test Circuit For Reference Impedance

**Pulse Response**

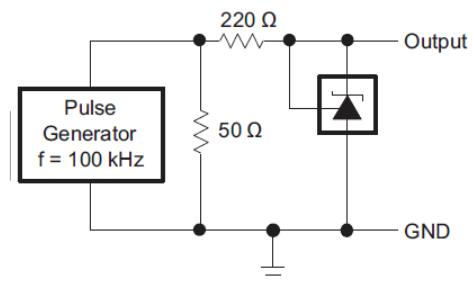
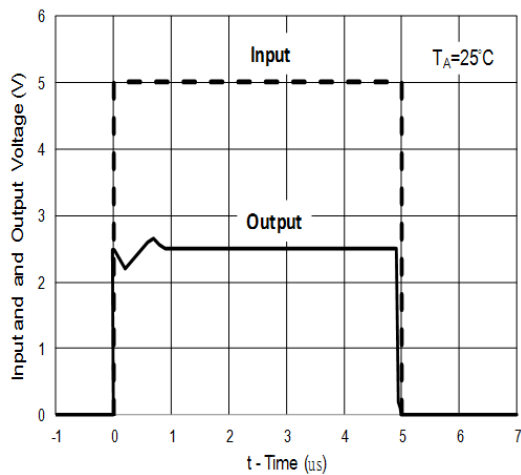

Test Circuit For Pulse Response

**TYPICAL PERFORMANCE CHARACTERISTICS**

**Stability Boundary Condition**

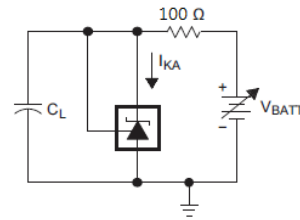
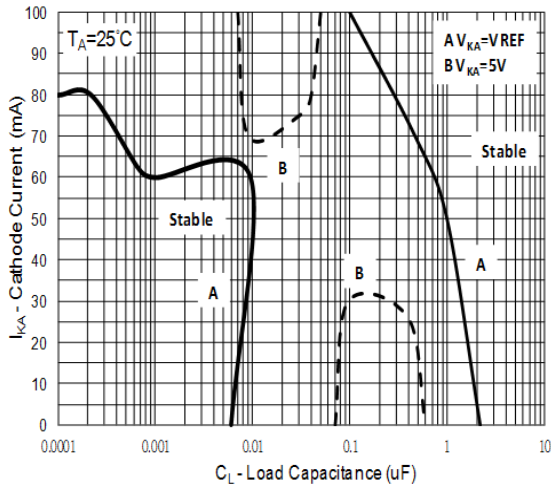

TEST CIRCUIT FOR CURVE A

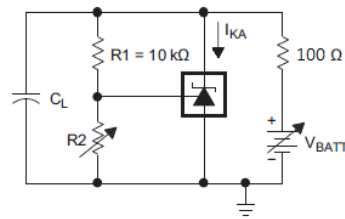

TEST CIRCUIT FOR CURVE B

**PACKAGE OUTLINE DIMENSIONS** (Unit: Millimeters)

**SOT-23**

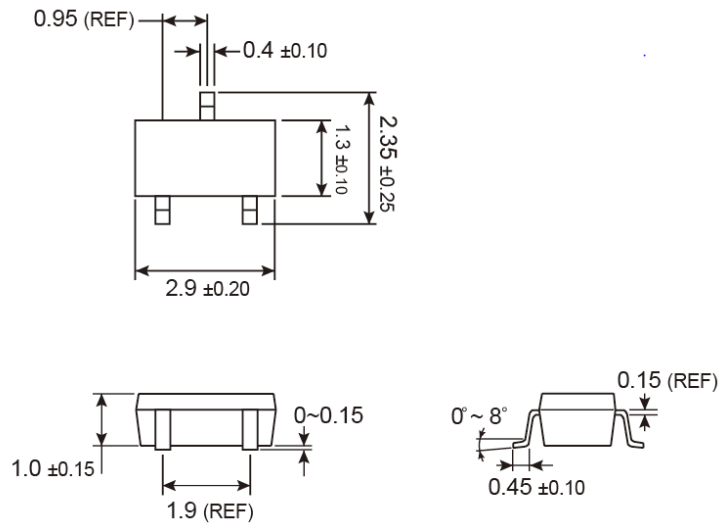

**SUGGESTED PAD LAYOUT** (Unit: Millimeters)

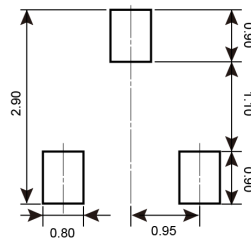

**MARKING DIAGRAM**

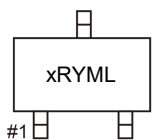

- xR** = Device code
  - A** = TS431A
  - B** = TS431B
- Y** = Year Code
- M** = Month Code for Halogen Free Product
  - O** =Jan    **P** =Feb    **Q** =Mar    **R** =Apr
  - S** =May    **T** =Jun    **U** =Jul    **V** =Aug
  - W** =Sep    **X** =Oct    **Y** =Nov    **Z** =Dec
- L** = Lot Code (1~9, A~Z)

## Notice

Specifications of the products displayed herein are subject to change without notice. TSC or anyone on its behalf, assumes no responsibility or liability for any errors or inaccuracies.

Information contained herein is intended to provide a product description only. No license, express or implied, to any intellectual property rights is granted by this document. Except as provided in TSC's terms and conditions of sale for such products, TSC assumes no liability whatsoever, and disclaims any express or implied warranty, relating to sale and/or use of TSC products including liability or warranties relating to fitness for a particular purpose, merchantability, or infringement of any patent, copyright, or other intellectual property right.

The products shown herein are not designed for use in medical, life-saving, or life-sustaining applications. Customers using or selling these products for use in such applications do so at their own risk and agree to fully indemnify TSC for any damages resulting from such improper use or sale.

## Данный компонент на территории Российской Федерации

### Вы можете приобрести в компании MosChip.

Для оперативного оформления запроса Вам необходимо перейти по данной ссылке:

<http://moschip.ru/get-element>

Вы можете разместить у нас заказ для любого Вашего проекта, будь то серийное производство или разработка единичного прибора.

В нашем ассортименте представлены ведущие мировые производители активных и пассивных электронных компонентов.

Нашей специализацией является поставка электронной компонентной базы двойного назначения, продукции таких производителей как XILINX, Intel (ex.ALTERA), Vicor, Microchip, Texas Instruments, Analog Devices, Mini-Circuits, Amphenol, Glenair.

Сотрудничество с глобальными дистрибьюторами электронных компонентов, предоставляет возможность заказывать и получать с международных складов практически любой перечень компонентов в оптимальные для Вас сроки.

На всех этапах разработки и производства наши партнеры могут получить квалифицированную поддержку опытных инженеров.

Система менеджмента качества компании отвечает требованиям в соответствии с ГОСТ Р ИСО 9001, ГОСТ РВ 0015-002 и ЭС РД 009

### Офис по работе с юридическими лицами:

105318, г.Москва, ул.Щербаковская д.3, офис 1107, 1118, ДЦ «Щербаковский»

Телефон: +7 495 668-12-70 (многоканальный)

Факс: +7 495 668-12-70 (доб.304)

E-mail: [info@moschip.ru](mailto:info@moschip.ru)

Skype отдела продаж:

moschip.ru

moschip.ru\_4

moschip.ru\_6

moschip.ru\_9