

0.5 dB LSB GaAs MMIC 5-BIT DIGITAL ATTENUATOR, 0.1 - 33 GHz

Typical Applications

The HMC941ALP4E is ideal for:

- Fiber Optics & Broadband Telecom
- Microwave Radio & VSAT
- Military Radios, Radar & ECM
- Space Applications
- Sensors
- Test & Measurement Equipment

Features

- 0.5 dB LSB Steps to 15.5 dB
- Single Positive Control Line Per Bit
- ±0.5 dB Typical Bit Error
- High Input IP3: +45 dBm
- 16mm² Leadless SMT Plastic Package

Functional Diagram

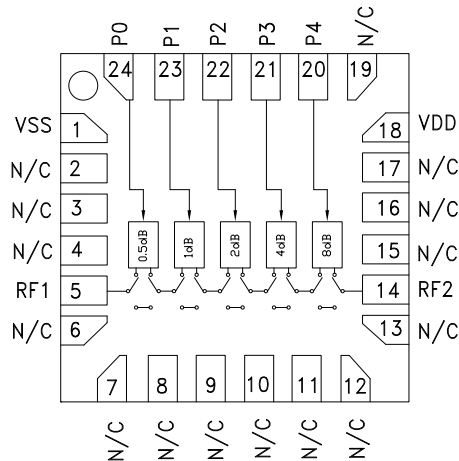

General Description

The HMC941ALP4E is a broadband 5-bit GaAs IC digital attenuators in low cost leadless surface mount packages. Covering 0.1 to 33.0 GHz, the insertion loss is less than 4 dB typical. The attenuator bit values are 0.5 (LSB), 1, 2, 4, 8, for a total attenuation of 15.5 dB. Attenuation accuracy is excellent at ±0.3 dB typical step error with an IIP3 of +45 dBm. Five control voltage inputs, toggled between +5V and 0V, are used to select each attenuation state.

Electrical Specifications, $T_A = +25^\circ C$, With $V_{dd} = +5V$, $V_{ss} = -5V$, $P_0 - P_4 = 0/ +5V$

Parameter	Frequency (GHz)	Min.	Typ.	Max.	Units
Insertion Loss	0.1 - 18.0 GHz		3.5	4.5	dB
	18.0 - 26.5 GHz		4.0	6.0	dB
	26.5 - 33.0 GHz		5.0	6.5	dB
Attenuation Range	0.1 - 33.0 GHz		15.5		dB
Return Loss (RF1 & RF2, All Atten. States)	0.1 - 33.0 GHz		12		dB
Attenuation Accuracy: (Referenced to Insertion Loss)	0.5 - 7.5 dB States	0.1 - 33.0 GHz	± (0.3 + 4% of Atten. Setting) Max		dB
	8 - 15.5 dB States	0.1 - 33.0 GHz	± (0.3 + 8% of Atten. Setting) Max		dB
Input Power for 0.1 dB Compression	0.1 - 0.5 GHz		22		dBm
	0.5 - 33.0 GHz		26		dBm
Input Third Order Intercept Point (Two-Tone Input Power = +8 dBm Each Tone)	0.1 - 0.5 GHz		45		dBm
	0.5 - 33.0 GHz		42		dBm
Switching Characteristics	0.1 - 33.0 GHz	tRISE, tFALL (10/90% RF)	40		ns
		tON/tOFF (50% CTL to 10/90% RF)	50		ns
I _{dd}	0.1 - 33.0 GHz	2.5	4.5	6.5	mA
I _{ss}	0.1 - 33.0 GHz	-7.0	-6.0	-3.0	mA

0.5 dB LSB GaAs MMIC 5-BIT DIGITAL ATTENUATOR, 0.1 - 33 GHz

Insertion Loss vs. Temperature

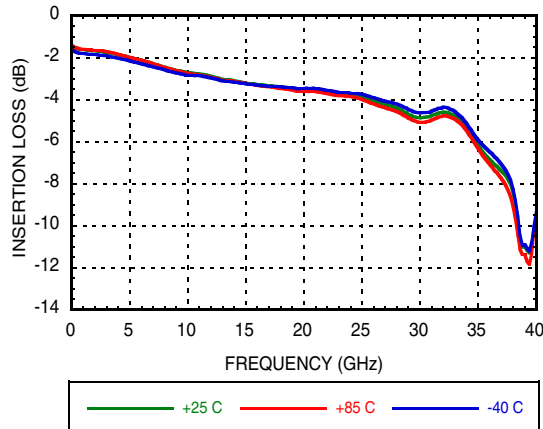

Normalized Attenuation
(Only Major States are Shown)

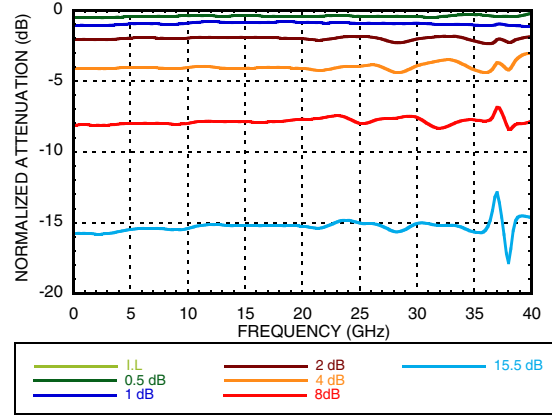

Input Return Loss
(Only Major States are Shown)

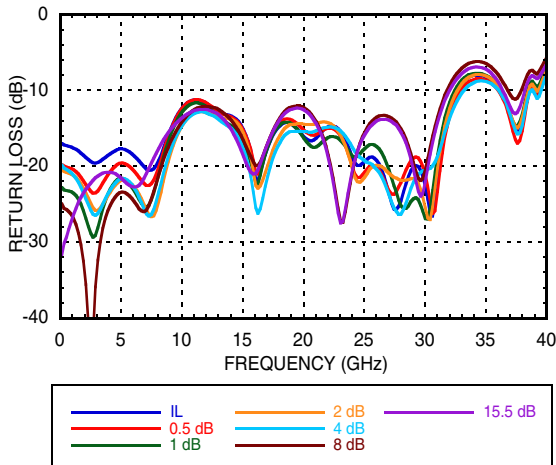

Output Return Loss
(Only Major States are Shown)

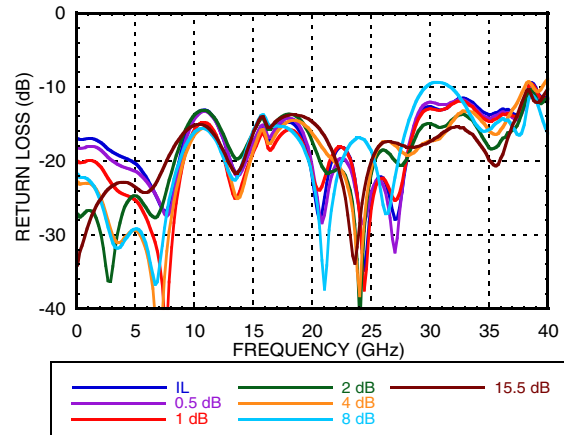

Bit Error vs. Attenuation State

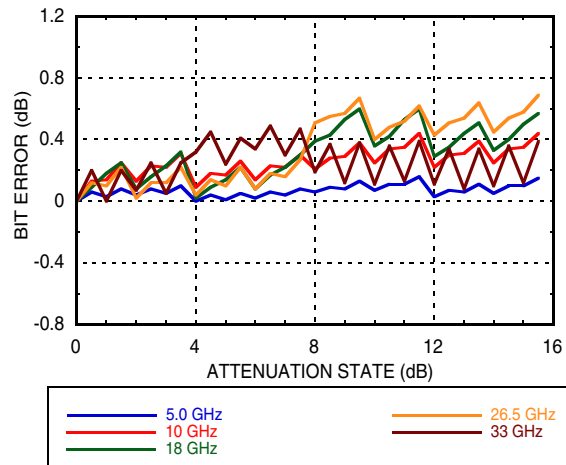

Bit Error vs. Frequency
(Only Major States are Shown)

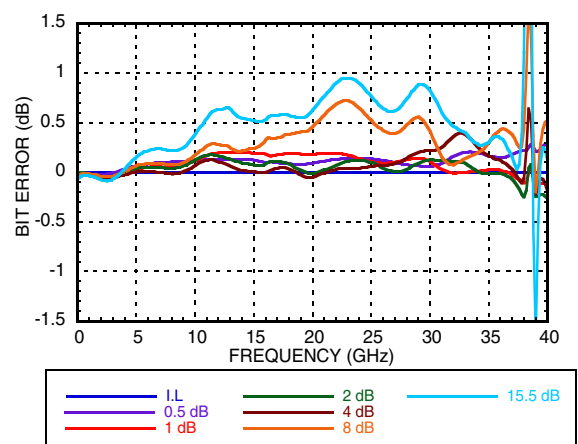

0.5 dB LSB GaAs MMIC 5-BIT DIGITAL ATTENUATOR, 0.1 - 33 GHz

Relative Phase vs. Frequency
(Only Major States are Shown)

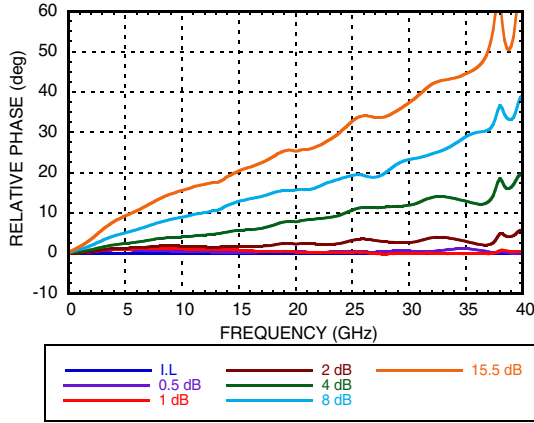

Step Attenuation vs. Attenuation State
0.1 - 18 GHz

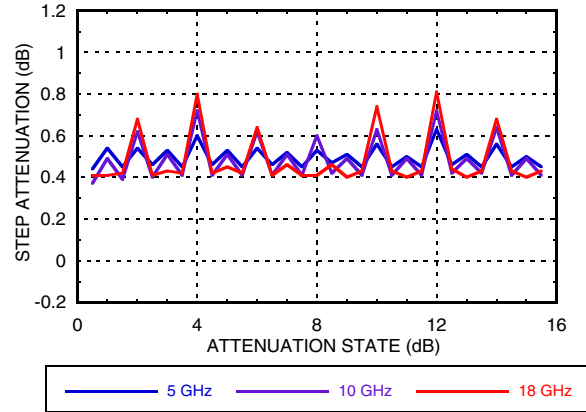

Step Attenuation vs. Attenuation State
18 - 33 GHz

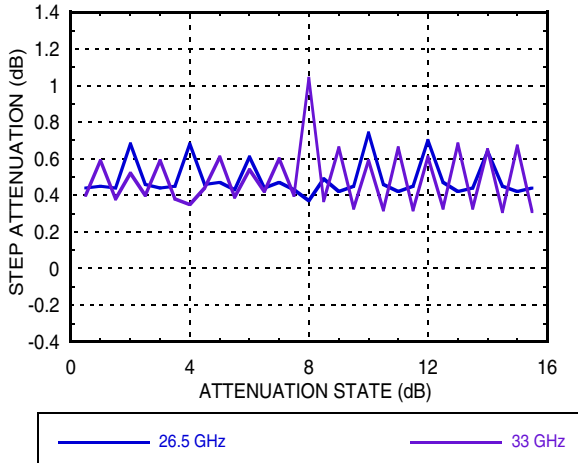

Input Power for 0.1 dB Compression

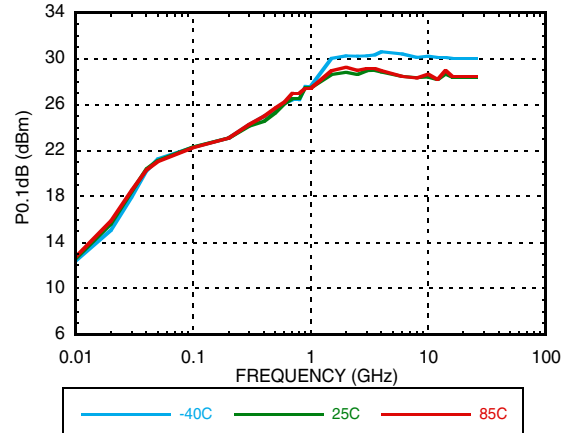

Input IP3 Over Major Attenuation States

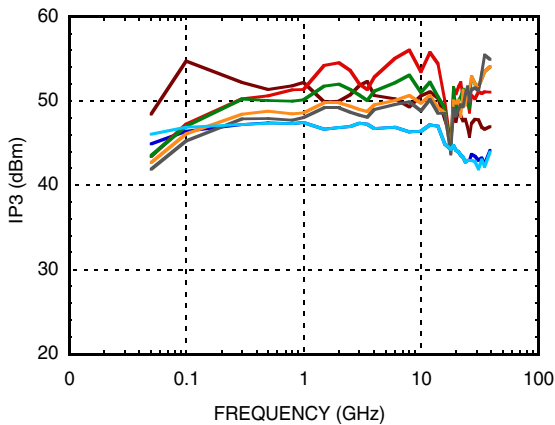

Input IP3 vs. Temperature
(Minimum Attenuation State)

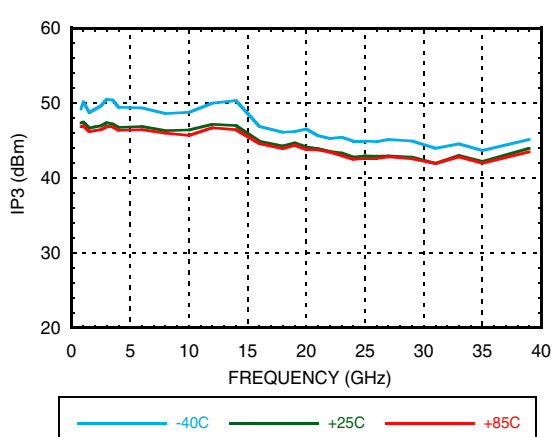

0.5 dB LSB GaAs MMIC 5-BIT DIGITAL ATTENUATOR, 0.1 - 33 GHz

Absolute Maximum Ratings

RF Input Power (0.1 to 33.0 GHz)	+27dBm
Control Voltage (P0 to P4)	Vdd+0.5
Vdd	+7 Vdc
Vss	-7 Vdc
Channel Temperature	150 °C
Continuous Pdiss (T = 85 °C) (derate 6.8 mW/°C above 85 °C)	0.453 W
Thermal Resistance	143.5 °C/W
Storage Temperature	-65 to 150 °C
Operating Temperature	-40 to +85 °C
ESD Sensitivity (HBM)	Class1A

Bias Voltages & Currents

Vdd	+5V @ 4.5 mA
Vss	-5V @ 6 mA

Control Voltage

State	Bias Condition
Low	0 to 0.8V @ 1 μA (Typ)
High	2 to 5V @ 1 μA (Typ)



ELECTROSTATIC SENSITIVE DEVICE
OBSERVE HANDLING PRECAUTIONS

Outline Drawing

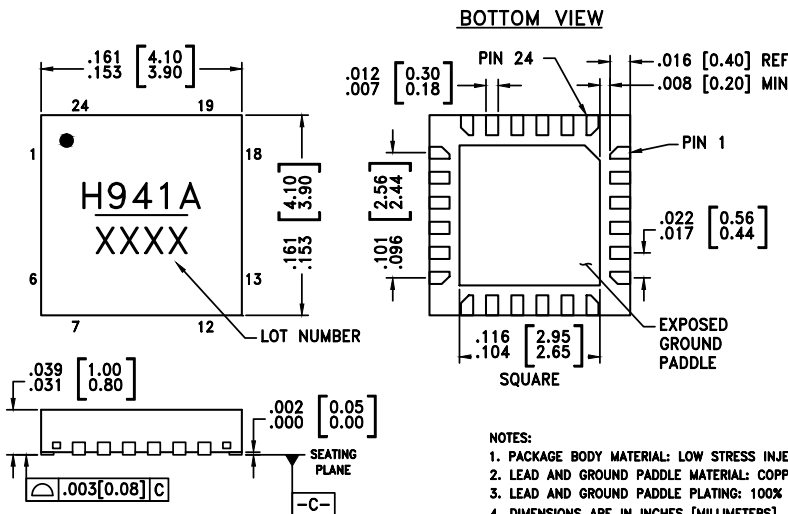

Package Information

Part Number	Package Body Material	Lead Finish	MSL Rating	Package Marking ^[2]
HMC941ALP4E	RoHS-compliant Low Stress Injection Molded Plastic	100% matte Sn	MSL3 ^[1]	H941A XXXX

[1] Max peak reflow temperature of 260 °C

[2] 4-Digit lot number XXXX



0.5 dB LSB GaAs MMIC 5-BIT DIGITAL ATTENUATOR, 0.1 - 33 GHz

Truth Table

Control Voltage Input					Attenuation State RF1 - RF2
P4 8 dB	P3 4 dB	P2 2 dB	P1 1 dB	P0 0.5 dB	
High	High	High	High	High	Reference I.L.
High	High	High	High	Low	0.5 dB
High	High	High	Low	High	1 dB
High	High	Low	High	High	2 dB
High	Low	High	High	High	4 dB
Low	High	High	High	High	8 dB
Low	Low	Low	Low	Low	15.5 dB

Any Combination of the above states will provide an attenuation approximately equal to the sum of the bits selected.

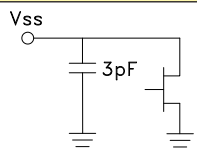
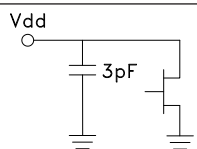
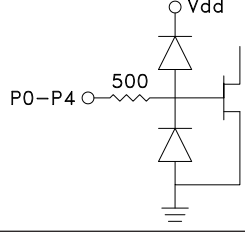
Pin Descriptions

Pad Number	Function	Description	Interface Schematic
1	Vss	Negative Bias -5V	
2-4, 6-13, 15-17, 19	N/C	The pins are not connected internally; however, all data shown herein was measured with these pins connected to RF/DC ground externally.	
5, 14	RF1, RF2	These pins are DC coupled and matched to 50 Ohm. Blocking capacitors are required if RF line potential is not equal to 0V.	
18	Vdd	Positive Bias +5V	
20 - 24	P0 - P4	See truth table and control voltage table.	
	GND	Package bottom must be connected to RF/DC ground.	

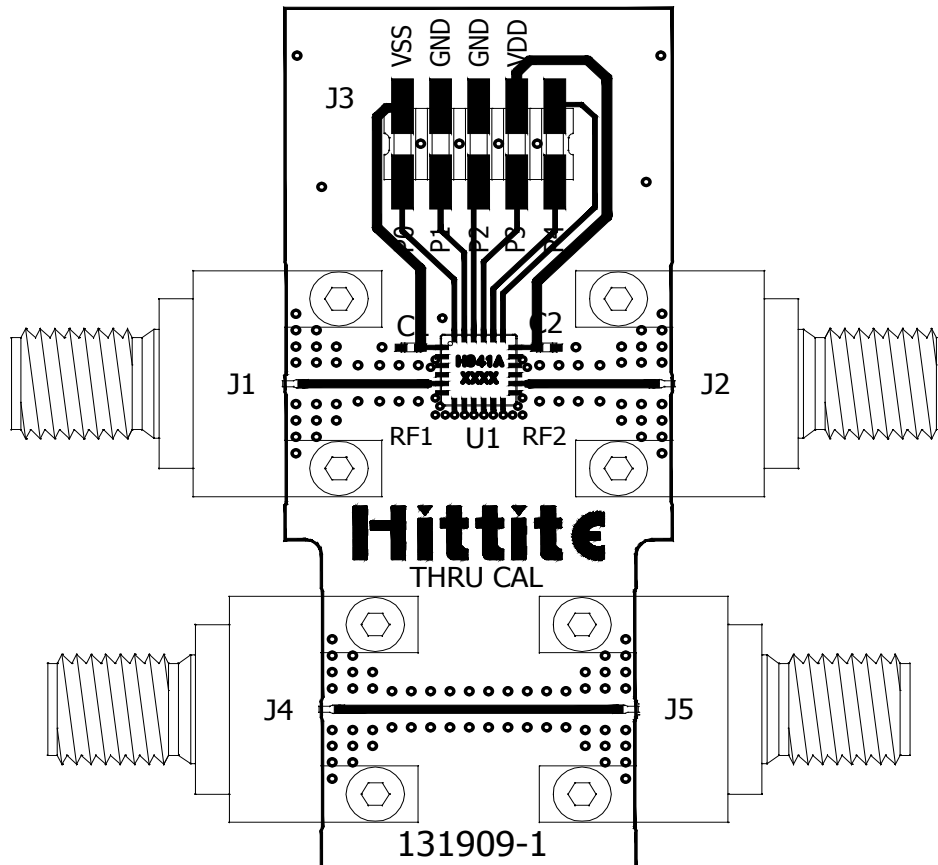
**0.5 dB LSB GaAs MMIC 5-BIT DIGITAL
ATTENUATOR, 0.1 - 33 GHz**
Evaluation PCB

List of Materials for Evaluation PCB EV1HMC941ALP4 [1]

Item	Description
J1, J2, J4, J5	2.9 mm PC Mount RF Connector
J3	DC Connector
C1, C2	1000 pF Capacitor, 0402 Pkg.
U1	HMC941ALP4E Digital Attenuator
PCB [2]	131909 Evaluation Board

[1] Reference this number when ordering complete evaluation PCB

[2] Circuit Board Material: Rogers 4350

The circuit board used in the application should use RF circuit design techniques. Signal lines should have 50 Ohm impedance while the package ground leads should be connected directly to the ground plane similar to that shown. A sufficient number of via holes should be used to connect the top and bottom ground planes. The evaluation circuit board shown is available from Analog Devices upon request.

Данный компонент на территории Российской Федерации

Вы можете приобрести в компании MosChip.

Для оперативного оформления запроса Вам необходимо перейти по данной ссылке:

<http://moschip.ru/get-element>

Вы можете разместить у нас заказ для любого Вашего проекта, будь то серийное производство или разработка единичного прибора.

В нашем ассортименте представлены ведущие мировые производители активных и пассивных электронных компонентов.

Нашей специализацией является поставка электронной компонентной базы двойного назначения, продукции таких производителей как XILINX, Intel (ex.ALTERA), Vicor, Microchip, Texas Instruments, Analog Devices, Mini-Circuits, Amphenol, Glenair.

Сотрудничество с глобальными дистрибьюторами электронных компонентов, предоставляет возможность заказывать и получать с международных складов практически любой перечень компонентов в оптимальные для Вас сроки.

На всех этапах разработки и производства наши партнеры могут получить квалифицированную поддержку опытных инженеров.

Система менеджмента качества компании отвечает требованиям в соответствии с ГОСТ Р ИСО 9001, ГОСТ РВ 0015-002 и ЭС РД 009

Офис по работе с юридическими лицами:

105318, г.Москва, ул.Щербаковская д.3, офис 1107, 1118, ДЦ «Щербаковский»

Телефон: +7 495 668-12-70 (многоканальный)

Факс: +7 495 668-12-70 (доб.304)

E-mail: info@moschip.ru

Skype отдела продаж:

moschip.ru

moschip.ru_4

moschip.ru_6

moschip.ru_9