

Powered by



# XTV1272

▶ 12V 7.2Ah

XTV 1272 is a general battery up to 12 years expected life in standby service or more than 260 cycles at 100% discharge in cycle service . XTV has a wider operating temperature range, which makes them more suitable for the systems in harsh conditions.



## ► Specification

<b>Cells Per Unit</b>	6
<b>Voltage Per Unit</b>	12
<b>Capacity</b>	7.2Ah @ 20hr-rate to 1.75V per cell @25°C (77°F)
<b>Weight</b>	Approx. 2.57 kg(5.67 lbs)
<b>Maximum Discharge Current</b>	130A(5sec)
<b>Internal Resistance</b>	Approx. 21mΩ
<b>Operating Temperature Range</b>	Discharge: -20°C~50°C (-4°F~122°F) Charge: -20°C~50°C (-4°F~122°F) Storage: -20°C~50°C (-4°F~122°F)
<b>Nominal Operating Temperature Range</b>	25°C±3°C (77°F±5°F)
<b>Float Charging Voltage</b>	13.5 to 13.8 VDC/unit Average at 25°C (77°F)
<b>Recommended Maximum Charging Current Limit</b>	2.16A
<b>Equalization and Cycle Service</b>	14.4 to 15.0 VDC/unit Average at 25°C (77°F)
<b>Self Discharge</b>	CSB Batteries can be stored for more than 6 months at 25°C(77°F). Please charge batteries before using . For higher temperatures the time interval will be shorter.
<b>Terminal</b>	F2-Faston Tab 250
<b>Container Material</b>	ABS(UL 94-HB) & Flammability resistance of (UL 94-V0) can be available upon request.



CSB-manufactured **VRLA (Absorbent Glass Mat type)** batteries are UL-recognized components under UL1989.

CSB is also certified by ISO 9001 and ISO 14001.

## ► Dimensions :

Unit: mm (inch)	Overall Height (H)	Container height (h)	Length (L)	Width (W)
	100.0±1.0 (3.94±0.04)	94.0±1.0 (3.70±0.04)	151.0±2.0 (5.94±0.08)	65.0±1.0 (2.56±0.04)

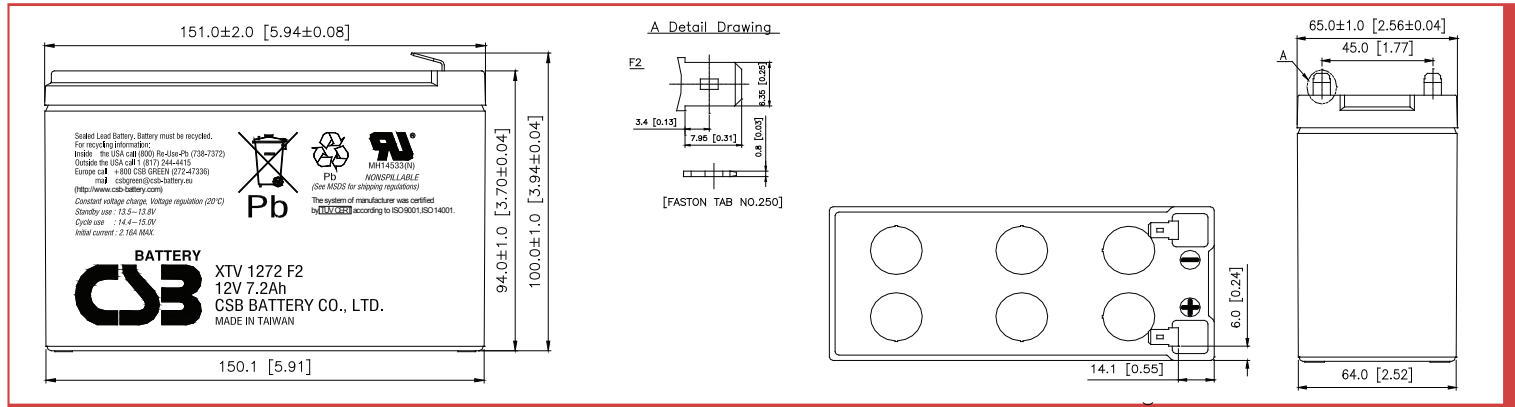

## Constant Current Discharge Characteristics Unit:A (25°C,77°F)

F.V/Time	5MIN	10MIN	15MIN	30MIN	60MIN	90MIN	2HR	3HR	5HR	8HR	10HR	20HR
1.60V	27.7	17.7	13.4	7.94	4.60	3.35	2.67	1.93	1.25	0.88	0.71	0.38
1.67V	26.8	17.4	13.3	7.87	4.47	3.28	2.63	1.89	1.24	0.87	0.70	0.38
1.70V	25.8	17.1	13.2	7.81	4.41	3.24	2.61	1.89	1.23	0.86	0.70	0.38
1.75V	24.6	16.4	12.9	7.74	4.31	3.21	2.60	1.88	1.22	0.84	0.69	0.37
1.80V	21.8	15.4	12.3	7.52	4.22	3.16	2.57	1.86	1.21	0.82	0.68	0.37
1.85V	18.3	13.9	11.2	7.10	4.10	3.06	2.48	1.79	1.19	0.80	0.66	0.36

## Constant Power Discharge Characteristics Unit:W (25°C,77°F)

F.V/Time	5MIN	10MIN	15MIN	30MIN	60MIN	90MIN	2HR	3HR	5HR	8HR	10HR	20HR
1.60V	299	193	149	89.8	54.8	40.0	32.1	23.1	15.2	10.3	8.64	4.68
1.67V	290	190	148	89.3	54.7	39.9	31.9	23.0	15.1	10.2	8.62	4.62
1.70V	282	188	147	88.8	54.5	39.8	31.8	22.9	15.0	10.1	8.59	4.60
1.75V	264	182	145	88.1	53.8	39.5	31.7	22.8	14.9	10.0	8.55	4.55
1.80V	239	173	138	86.3	53.2	39.1	31.4	22.7	14.8	9.92	8.50	4.50
1.85V	206	160	128	82.3	51.8	37.8	30.2	21.9	14.7	9.84	8.26	4.44

Ratings presented herein are subject to revision without notice. Please refer to [www.csb-battery.com](http://www.csb-battery.com) to confirm the latest version.

### Trickle (or Float) Service Life

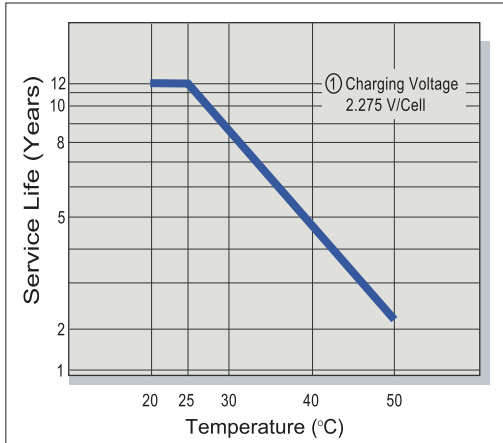

### Capacity Retention Characteristic

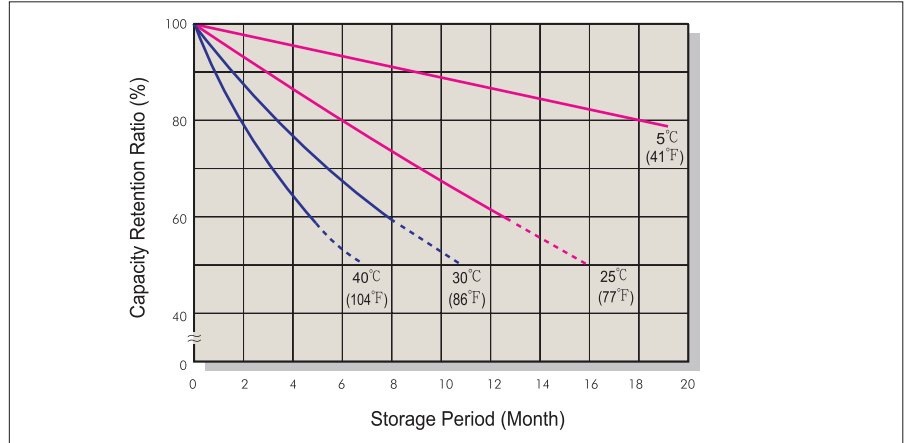

### Battery Voltage and Charge Time for Standby Use

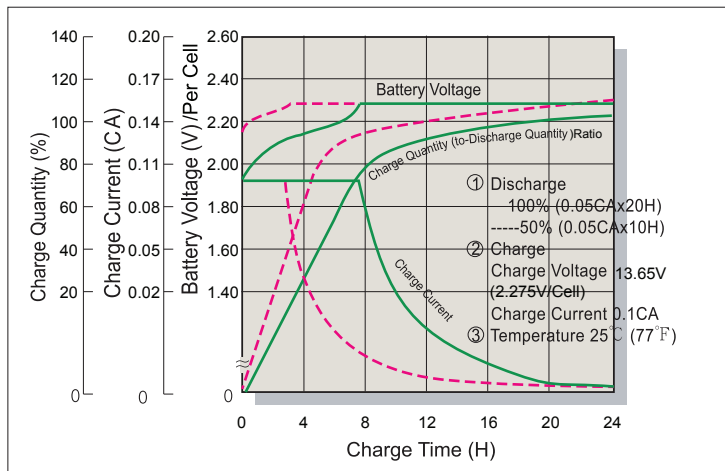

### Cycle Service Life

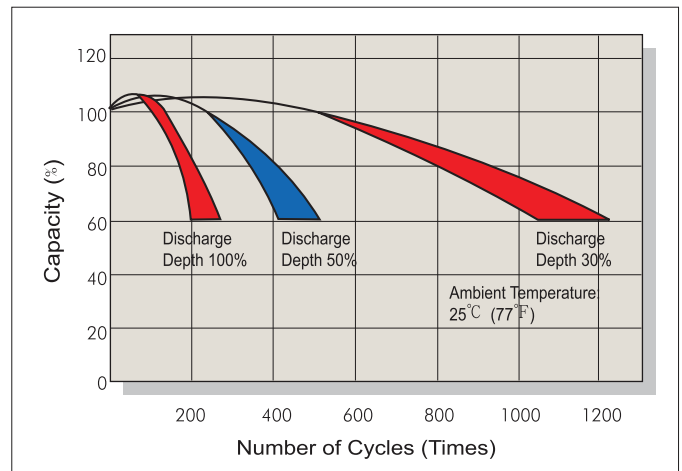

### Battery Voltage and Charge Time for Cycle Use

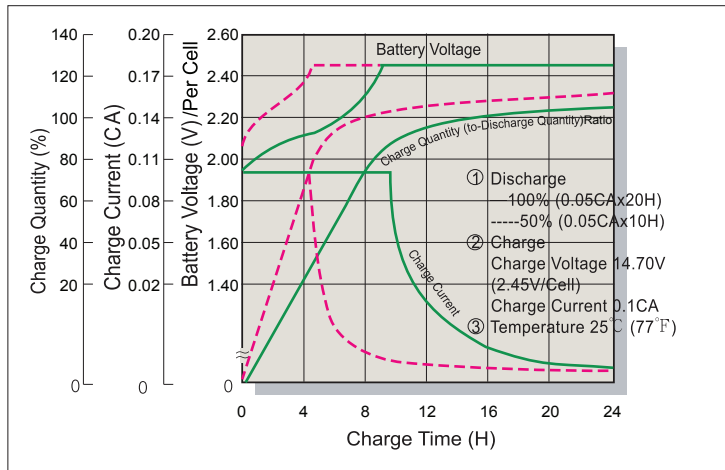

### Terminal Voltage (V) and Discharge Time

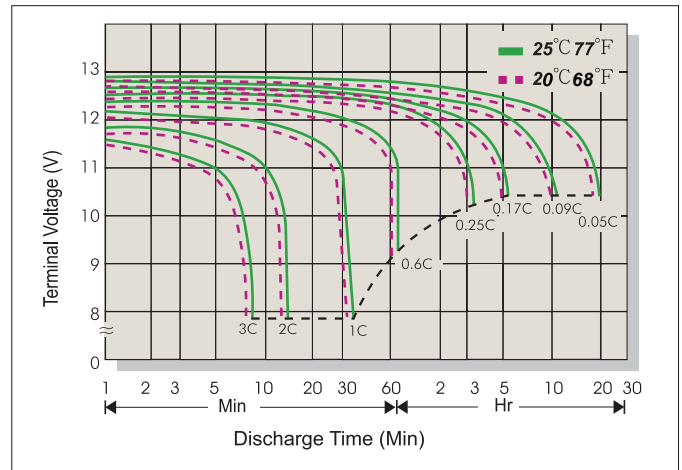

### Charging Procedures

Application	Charge Voltage(V/Cell)			Max. Charge Current
	Temperature	Set Point	Allowable Range	
Cycle Use	25°C(77°F)	2.45	2.40~2.50	0.3C
Standby	25°C(77°F)	2.275	2.25~2.30	

### Discharge Current VS. Discharge Voltage

Final Discharge Voltage V/Cell	1.75	1.70	1.60	1.30
Discharge Current(A)	0.2C>(A)	0.2C<(A)<0.5C	0.5C<(A)<1.0C	(A)>1.0C

Sales Office URL: [WWW.CSB-BATTERY.COM](http://WWW.CSB-BATTERY.COM)

**GLOBAL HQ**  
**CSB BATTERY CO., LTD. (TAIWAN)**  
 Tel : +886-2-2880-5600  
 Fax : +886-2-2888-3300  
 mail : service@csb-battery.com.tw

**BEIJING OFFICE. (CHINA)**  
**CSB BATTERY TECHNOLOGIES (BEIJING) CO., LTD.**  
 Tel : +86-10-5820-5336/5338  
 Fax : +86-10-58203053  
 mail : chinasl@csb-battery.com

**AMERICA HQ**  
**CSB BATTERY TECHNOLOGIES INC. (U.S.A)**  
 Tel : +1-817-244-7777/1-(800)3-CSB-USA(272872)  
 Fax : +1-817-244-4445  
 mail : csb@csb-battery.com

**SHANGHAI OFFICE. (CHINA)**  
**CSB BATTERY LOGISTIC (SHANGHAI) CO., LTD.**  
 Tel : +86-21-5046-1622/5046-0833  
 Fax : +86-21-5064-1046  
 mail : chinasl@csb-battery.com

**EUROPE HQ**  
**CSB Battery Europe BV.**  
 Tel : +31(0)-180-418-140  
 Fax : +31(0)-180-418-327  
 mail : eurosales@csb-battery.eu

**SHENZHEN OFFICE. (CHINA)**  
**CSB BATTERY LOGISTIC (SHANGHAI) CO., LTD.**  
 Tel : +86-755-8831-6488/6396/6356  
 Fax : +86-755-8831-6548  
 mail : she@csb-battery.com.cn

## Данный компонент на территории Российской Федерации

### Вы можете приобрести в компании MosChip.

Для оперативного оформления запроса Вам необходимо перейти по данной ссылке:

<http://moschip.ru/get-element>

Вы можете разместить у нас заказ для любого Вашего проекта, будь то серийное производство или разработка единичного прибора.

В нашем ассортименте представлены ведущие мировые производители активных и пассивных электронных компонентов.

Нашей специализацией является поставка электронной компонентной базы двойного назначения, продукции таких производителей как XILINX, Intel (ex.ALTERA), Vicor, Microchip, Texas Instruments, Analog Devices, Mini-Circuits, Amphenol, Glenair.

Сотрудничество с глобальными дистрибьюторами электронных компонентов, предоставляет возможность заказывать и получать с международных складов практически любой перечень компонентов в оптимальные для Вас сроки.

На всех этапах разработки и производства наши партнеры могут получить квалифицированную поддержку опытных инженеров.

Система менеджмента качества компании отвечает требованиям в соответствии с ГОСТ Р ИСО 9001, ГОСТ РВ 0015-002 и ЭС РД 009

### Офис по работе с юридическими лицами:

105318, г.Москва, ул.Щербаковская д.3, офис 1107, 1118, ДЦ «Щербаковский»

Телефон: +7 495 668-12-70 (многоканальный)

Факс: +7 495 668-12-70 (доб.304)

E-mail: [info@moschip.ru](mailto:info@moschip.ru)

Skype отдела продаж:

moschip.ru

moschip.ru\_4

moschip.ru\_6

moschip.ru\_9