

## Type VR Vertical Mounting Clamp

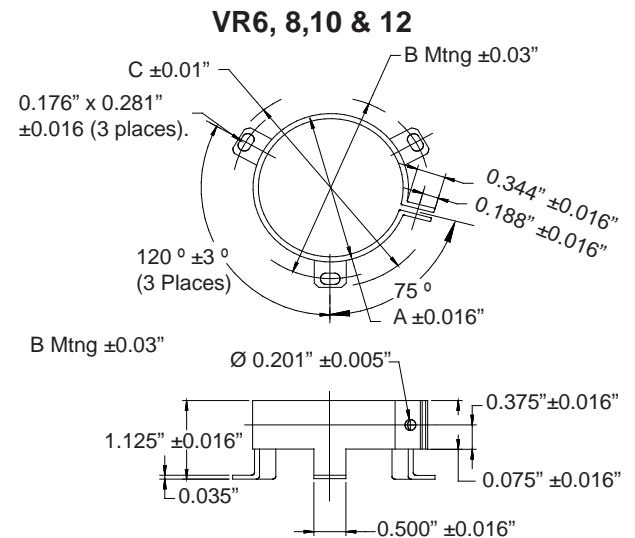

| Diameter of Part to be Mounted | Catalog Part Number |                                  |                            | Dimensions                     |          |          |
|--------------------------------|---------------------|----------------------------------|----------------------------|--------------------------------|----------|----------|
|                                | Without Screw & Nut | Unassembled Screw & Nut Included | Assembled with Screw & Nut | A                              | B        | C        |
| 1" to 1-1/16                   | VR1B                | VR1                              | VR1A                       | 1"                             | 1-7/16"  | 1-7/8"   |
| 1-3/8" to 1-7/16               | VR3B                | VR3                              | VR3A                       | 1-3/8"                         | 1-25/32" | 2-7/32"  |
| 1-1/2" to 1-9/16               | VR4B                | VR4                              | VR4A                       | 1-1/2"                         | 1-15/16" | 2-11/32" |
| 1-3/4" to 1-13/16              | VR6B                | VR6                              | VR6A                       | 1-3/4"                         | 2-1/4"   | 2-9/16"  |
| 2" to 2-1/16                   | VR8B                | VR8                              | VR8A                       | 2"                             | 2-1/2"   | 2-13/16" |
| 2-1/2" to 2-9/16               | VR10B               | VR10                             | VR10A                      | 2-1/2"                         | 3"       | 3-5/16"  |
| 3" to 3-1/8                    | VR12B               | VR12                             | VR12A                      | 3"                             | 3-7/16"  | 3-13/16" |
| Screw                          | VRSCREW             | —                                | —                          | 9/16" long 6-32 thread NC-2A   |          |          |
| Nut                            | VRNUT               | —                                | —                          | Standard hex nut to fit screws |          |          |

CDE VR mounting clamps may be used to mount any cylindrical capacitor with a 1" to 3" diameter that is to be mounted in a vertical position. Material is 1010 CRS, commercial grade #4 temper ASI scale. Parts are finished with .0001 (nominal) zinc chromate plating. Use for mounting CG types, PSU, SF and MPF types. Material thickness is .035"

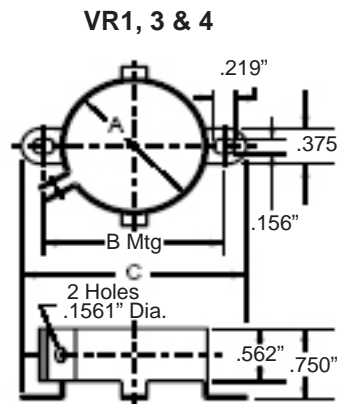

## Type TH Horizontal Mounting Clip

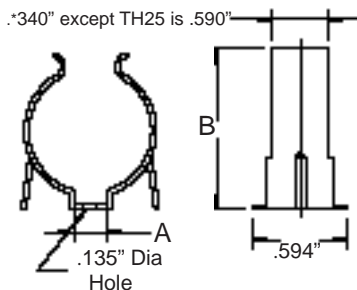

| Catalog Part Number | Dimensions in Inches               |      |      |
|---------------------|------------------------------------|------|------|
|                     | Nominal Dia. of Part to be Mounted | A    | B    |
| TH13                | .375                               | .250 | .47  |
| TH17                | .625                               | .312 | .72  |
| TH21                | .875                               | .312 | 1.00 |
| TH23                | 1.000                              | .312 | 1.06 |
| TH25                | 1.375                              | .312 | 1.50 |

These clips, though designed for capacitors, have varied applications to retain many cylindrical components. They are used extensively in the electrical and electronic industries to hold spindles, condensers, capacitors, tubes, rods and conduit. Clips have phosphate and oil finish.

Material thickness TH13 thru TH17 is .016". TH21 thru TH25 is .020"

### ACR15KT Motor Start Resistor Kit



15K Ohm 2 watt bleeder resistors for AC motor start applications. Saves relay switch contacts and capacitor, particularly in capacitor start applications. 1/4" quick connect terminals eliminate need for soldering.

ACR15K:

Pack of 10, 15K Ohm 2 watt bleeder resistor without quick connect terminals.

### ACR220KT Motor Run Resistor Kit



220K Ohm 1 watt bleeder resistors for AC motor run applications. Saves relay switch contacts and capacitor, particularly in capacitor run applications. 1/4" quick connect terminals eliminate need for soldering.

ACR220K:

Pack of 10, 220K Ohm 1 watt bleeder resistor without quick connect terminals.

# Capacitor Hardware

## Oval Capacitor Hardware

### Mounting Brackets #32107

| Case Code | Bracket |
|-----------|---------|
| A         | 32107-1 |
| C         | 32107-2 |
| D         | 32107-3 |



6-32 Screw and Nut

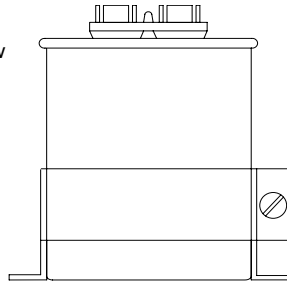

### Insulating Terminal Boots UL Approved Material

44603

32108-2

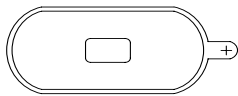

## Round Capacitor Hardware

### 3 Footed Round Mounting Bracket

| Case Code | Bracket |
|-----------|---------|
| P         | VR6B    |
| S         | VR8B    |
| T         | VR10B   |

### 2 Footed Round Mounting Bracket

| Case Code | Bracket |
|-----------|---------|
| P         | 32107-6 |
| S         | 32107-7 |
| T         | 32107-8 |

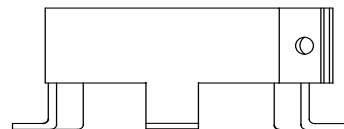
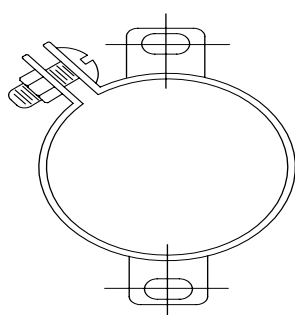
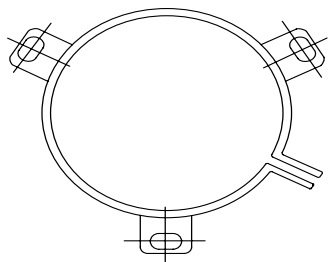

Wrap Around Bracket

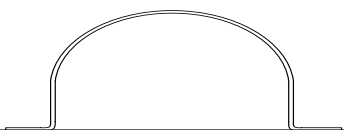

| Case Code | Bracket |
|-----------|---------|
| P         | RB175   |
| S         | RB200   |
| T         | RB250   |

### End Mount Footed Bracket (2 required) #30434

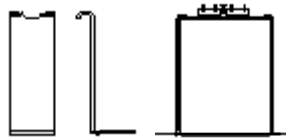

### Side Mount Footed Bracket (2 required) #31762

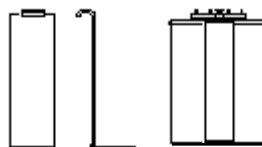

| H (Inches) | End Mount | Side Mount |
|------------|-----------|------------|
| 2.13       | 30434-33  | 31762-45   |
| 2.38       | 30434-37  | 31762-46   |
| 2.63       | 30434-41  | 31762-47   |
| 2.88       | 30434-45  | 31762-48   |
| 3.13       | 30434-49  | 31762-49   |
| 3.50       | 30434-55  | 31762-50   |
| 3.75       | 30434-59  | 31762-83   |
| 3.88       | 30434-61  | 31762-51   |
| 4.25       | 30434-67  | 31762-52   |
| 4.75       | 30434-75  | 31762-54   |
| 5.13       | 30434-81  | 31762-132  |
| 5.25       | 30434-83  | 31762-55   |
| 5.75       | 30434-91  | 31762-56   |
| 6.25       | 30434-99  | 31762-59   |
| 6.75       | 30434-107 | 31762-60   |
| 7.25       | 30434-115 | 31762-62   |
| 8.00       | 30434-127 | 31762-63   |
| 9.00       | 30434-143 | 31762-78   |

### Wrap Around Bracket

| Case Code | Bracket |
|-----------|---------|
| A         | 30393-5 |
| C         | 30393-9 |
| D         | OB3     |

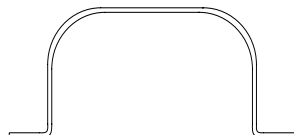
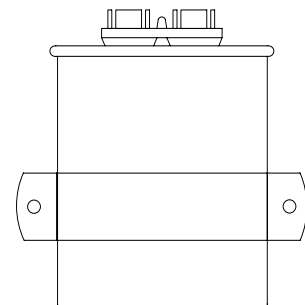

## Motor Start Mounting Hardware

### Bracket



### End Cap

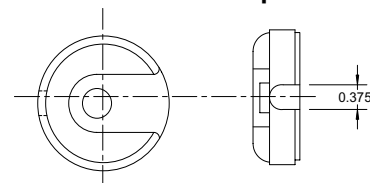

| Case Code | Case Dimensions (Inches) |       | Down Wire Cap | Up Wire Cap | Optional Mounting Bracket |
|-----------|--------------------------|-------|---------------|-------------|---------------------------|
|           | D                        | L     |               |             |                           |
| 1         | 1.438                    | 2.750 | PL3           | PLA3        | HB2                       |
| 2         | 1.438                    | 3.375 | PL3           | PLA3        | HB4                       |
| 3         | 1.438                    | 4.375 | PL3           | PLA3        | HB8                       |
| 4         | 1.813                    | 3.375 | PL6           | PLA6        | HB4                       |
| 5         | 1.813                    | 4.375 | PL6           | PLA6        | HB8                       |
| 6         | 2.063                    | 3.375 | PL8           | PLA8        | HB4                       |
| 7         | 2.063                    | 4.375 | PL8           | PLA8        | HB8                       |
| 8         | 2.563                    | 4.375 | PL10          | PLA10       | HB8                       |

Order both endcap and bracket for mounting

## Screw-Terminal, Computer-Grade Capacitor, Mounting Hardware

Figure 1



Figure 2



Figure 3



Figure 4



## Clamp Dimensions

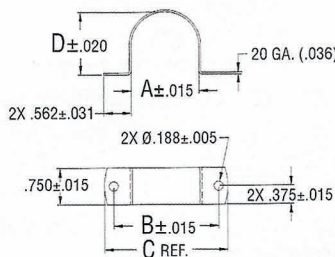

| Clamp Number | Dimensions in Inches |       |       |       |
|--------------|----------------------|-------|-------|-------|
|              | A                    | B     | C     | D     |
| 125562-01    | 1.375                | 2.125 | 2.500 | 1.281 |
| 125562-05    | 1.750                | 2.500 | 2.875 | 1.656 |
| 125562-02    | 2.000                | 2.750 | 3.125 | 1.906 |
| 125562-04    | 2.500                | 3.250 | 3.625 | 2.406 |
| 125562-03    | 3.000                | 3.750 | 4.125 | 2.906 |
| 125562-06    | 3.500                | 4.250 | 4.625 | 3.481 |

## Bracket Dimensions

| Figure | Bracket Number | Dimensions in Inches |       |      |       |       |      | Dimensions in Millimeters |        |     |        |       |       |
|--------|----------------|----------------------|-------|------|-------|-------|------|---------------------------|--------|-----|--------|-------|-------|
|        |                | A                    | B     | C    | D     | E     | F    | A                         | B      | C   | D      | E     | F     |
| 1      | 125565-06*     | 1.375                | 1.813 | 30 ° | 2.313 | .750  | .563 | 34.93                     | 46.04  | 30° | 58.74  | 19.05 | 14.30 |
| 1      | 125565-15*     | 1.750                | 2.188 | 30 ° | 2.625 | .750  | .560 | 44.45                     | 55.56  | 30° | 66.68  | 19.05 | 14.22 |
| 2      | 125565-09*     | 2.000                | 1.250 | 75 ° | 1.438 | 1.125 | .750 | 50.80                     | 31.75  | 75° | 36.51  | 28.58 | 19.05 |
| 3      | 125565-05      | 2.000                | 2.563 | 30 ° | 2.938 | 1.125 | .750 | 50.80                     | 65.09  | 30° | 76.41  | 28.58 | 19.05 |
| 2      | 125565-14*     | 2.500                | 1.500 | 75 ° | 1.688 | 1.125 | .750 | 63.50                     | 38.10  | 75° | 42.86  | 28.58 | 19.05 |
| 3      | 125565-10      | 2.500                | 3.000 | 30 ° | 3.438 | 1.125 | .750 | 63.50                     | 76.20  | 30° | 87.31  | 28.58 | 19.05 |
| 2      | 125565-11*     | 3.000                | 1.750 | 75 ° | 1.938 | 1.125 | .750 | 76.20                     | 44.45  | 75° | 49.21  | 28.58 | 19.05 |
| 3      | 125565-01      | 3.000                | 3.500 | 30 ° | 3.938 | 1.125 | .750 | 76.20                     | 88.90  | 30° | 100.01 | 28.58 | 19.05 |
| 4      | 125309-01      | 3.500                | 4.488 | 60 ° | 2.224 | .984  | —    | 90.00                     | 114.00 | 60° | 4.70   | 25.00 | —     |

Note: All mounting brackets and clamps except Figure 4 are zinc plated. Figure 4 is a black nylon. When mounting capacitors there is no need to wrap capacitors with protective wrapping before installing mounting clamp.

\*Stock bracket

## Nylon Nuts for Insulated Stud Mounting



| Nylon Nut Part Number | For Stud Diameter (mm) | Standoff Diameter S (mm) | Nut Diameter W (mm) | Nut Elevation T (mm) | Hex Head J (mm) | Mounting                |                             |                                 |
|-----------------------|------------------------|--------------------------|---------------------|----------------------|-----------------|-------------------------|-----------------------------|---------------------------------|
|                       |                        |                          |                     |                      |                 | Min. Hole Diameter (mm) | Max. Chassis Thickness (mm) | Max. Tightening Torque in. lbs. |
| M8S17W25              | M8                     | 17                       | 25                  | 14                   | 17              | 17.5                    | 5                           | 25                              |
| M12S22W30             | M12                    | 22                       | 30                  | 16                   | 19              | 22.5                    | 5                           | 75                              |
| M12S30W38             | M12                    | 30                       | 38                  | 16.5                 | 19              | 30.5                    | 5                           | 75                              |

## Данный компонент на территории Российской Федерации

### Вы можете приобрести в компании MosChip.

Для оперативного оформления запроса Вам необходимо перейти по данной ссылке:

<http://moschip.ru/get-element>

Вы можете разместить у нас заказ для любого Вашего проекта, будь то серийное производство или разработка единичного прибора.

В нашем ассортименте представлены ведущие мировые производители активных и пассивных электронных компонентов.

Нашей специализацией является поставка электронной компонентной базы двойного назначения, продукции таких производителей как XILINX, Intel (ex.ALTERA), Vicor, Microchip, Texas Instruments, Analog Devices, Mini-Circuits, Amphenol, Glenair.

Сотрудничество с глобальными дистрибьюторами электронных компонентов, предоставляет возможность заказывать и получать с международных складов практически любой перечень компонентов в оптимальные для Вас сроки.

На всех этапах разработки и производства наши партнеры могут получить квалифицированную поддержку опытных инженеров.

Система менеджмента качества компании отвечает требованиям в соответствии с ГОСТ Р ИСО 9001, ГОСТ РВ 0015-002 и ЭС РД 009

### Офис по работе с юридическими лицами:

105318, г.Москва, ул.Щербаковская д.3, офис 1107, 1118, ДЦ «Щербаковский»

Телефон: +7 495 668-12-70 (многоканальный)

Факс: +7 495 668-12-70 (доб.304)

E-mail: [info@moschip.ru](mailto:info@moschip.ru)

Skype отдела продаж:

moschip.ru

moschip.ru\_4

moschip.ru\_6

moschip.ru\_9