

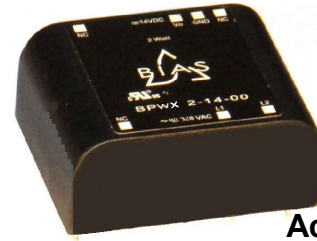

BIAS 2 Watt Power Supply BPWX 2 Series Data Sheet

Single (Vo) or Dual (Vo & Vr) output
BPWX 2-08-00, -08-33, -08-50
BPWX 2-14-00, -14-33, -14-50
BPWX 2-24-00, -24-33, -24-50



CAUS

Actual Size

The BPWX Power Supply Module is an ideal solution for numerous control applications in lighting, sensing, smart building and power distribution where operation from 277VAC mains and an extended temperature range are required. This low-cost supply provides up to two watts of output power at 8, 14 or 24VDC (Vo) and an optional 3.3 or 5 VDC (Vr) output for logic functions such as a microprocessor, logic, timing circuits, transceivers or sensors. A patented design incorporating a custom integrated circuit into a small package (0.87 in³ [14.3 cm³]) the BIAS Module provides an immediate “drop-in” solution, requiring no additional external components.

Operating Specifications

(@120VAC / 60 Hz / 25°C unless otherwise specified)

| Electrical | |
|------------------------------------|--|
| Input Voltage Range | 90-308 VAC (50/60Hz) |
| Input Surge Withstand | 345V, < 30 sec |
| Output Power (Pmax) | 2.0 W min. (60Hz) 1.67 W min. (50Hz) |
| Efficiency | 70% nom. |
| Output Vo (Peak) | 8 or 14 VDC nom. +/- 5% |
| Line / Load Regulation Vo (Peak) | +/- 1% Po < Pmax |
| Temperature Regulation Vo (Peak) | +/- 2% Po < Pmax |
| Ripple Vo (@120 Hz) (@ 100 kHz) | 1.00 V p:p 0.25 V p:p |
| Output Vr, 3.3 volt (+/- 5%) | For Vo = 8V, Ir out 160mA max, Io+Ir ≤ 250mA* For Vo = 14V, Ir out 70mA max, Io+Ir ≤ 143mA* For Vo = 24V, Ir out 36mA max, Io+Ir ≤ 83mA* |
| Output Vr, 5.0 volt (+/- 5%) | For Vo = 8V, Ir out 250mA max, Io+Ir ≤ 250mA* For Vo = 14V, Ir out 83mA max, Io+Ir ≤ 143mA* For Vo = 24V, Ir out 39mA max, Io+Ir ≤ 83mA* |
| No-load Consumption | 30 mW typical @ Vin=120 VAC |
| Isolation | 3000 VAC (meets UL / CSA & EN Product Safety) |
| Earth Leakage @ 120 VAC | < 10 uA |
| Short Circuit Protection | Continuous, Pin ≤ 0.6 w @ Vin = 120 VAC |
| Reliability @ 25° C, MIL HDBK-217F | > 500 Khr MTBF |
| Thermal | |
| Operating Temperature | -40 to +85° C |
| Operating Relative Humidity | 0 – 95%, non-condensing |
| Storage Temperature | -40 to +105° C |
| Mechanical | |
| Package Size (L x W x H) | 1.35 x 1.12 x 0.58 inches [34.214 x 28.372 x 14.757 mm] |
| Safety | |
| Safety Compliance | UL/EN 60950-1, 2 nd Ed. (CB Report Available) |
| EMI Emissions | EN 55022, Class B, FCC Part 15, Class B |

Features

- **Universal Input (90-308 VAC, 50/60Hz)**
- **Extended temperature range (-40 to 85° C)**
- **Small Size—0.87in³ [14.3cm³]**
- **Low no-load input power <30mW**
- **Constant power mode, not current limit**
- **3000 VAC Isolation**
- **Up to 75% efficiency**
- **EN 55022, Class B; FCC Part 15, Class B**
- **Meets UL/CSA and EN Product Safety (ITE)**

Bias Power AC/DC power supplies are designed to be applied in two major categories of applications...

Auxiliary, where the Bias supply is one of two or more supplies and provides power for standby, housekeeping, biasing or other requirements. Generally, these supply 3.3V or 5.0V requirements from the Vr output. In some cases a small amount of Vo power is used.

Second is as a main or utility supply where Bias is the only supply and provides all power necessary for the product or system. Both Vr and Vo supplies are often utilized for optimum system performance.

The characteristics of the Vo and Vr outputs are different and each has application-specific benefits which can provide high value to the system designer.

Vo is a voltage-regulated output which has a constant power mode instead of a conventional current limit. This output is best suited to drive mechanical relays, solenoids, SSRs, capacitive loads, indicating lights, LEDs and as a source for isolated DC utility power which may be used directly or post-regulated with either a linear regulator or a DC/DC converter. Vo is self protecting, cannot be overloaded and can be shorted indefinitely. The graceful transition from voltage regulation to constant power along with the wide range of product ratings, allows the designer to select a supply tightly matched to the design load. There is no need to oversize a Bias Power supply. Unlike design-your-own, or partially complete modules where significant design margin is required, to stay far away from current limit, Bias's constant power alternative requires no such over-spec'ing.

Vr is also a voltage-regulated output and is thermally protected from overload. It has very low output ripple capable of driving microprocessors, logic, transceivers, sensors and other elements which require a low-noise, tightly-regulated supply. In addition, Vr is supplied internally by Vo. This means that any capacitance added to Vo can increase the hold-up time of Vr as well.

*Note: maximum currents specified for constant voltage range only. See V-I curve on page 2 for Vo in constant power range.



BIAS 2 Watt Power Supply

BPWX 2 Series Data Sheet

Single (Vo) or Dual (Vo & Vr) output

BPWX 2-08-00, -08-33, -08-50

BPWX 2-14-00, -14-33, -14-50

BPWX 2-24-00, -24-33, -24-50

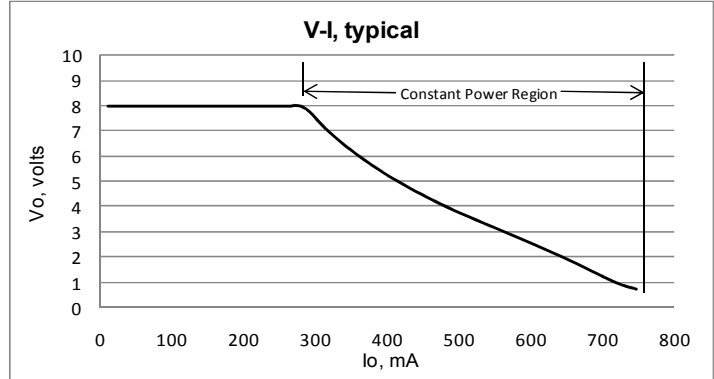
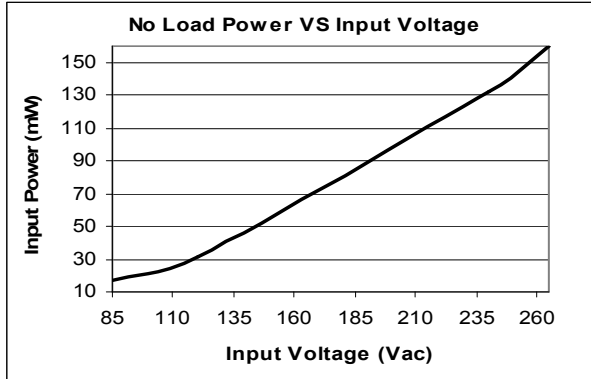

EMI, conducted, dB μ V, typical

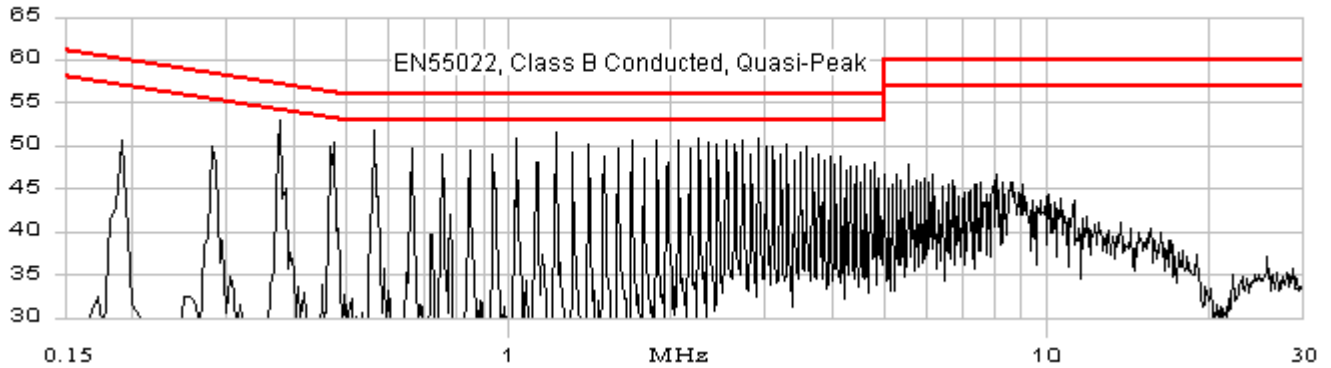

EMI, radiated signal strength, dB μ V/m, typical

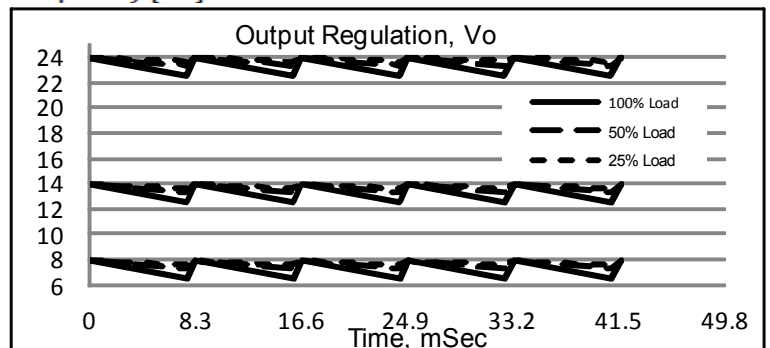
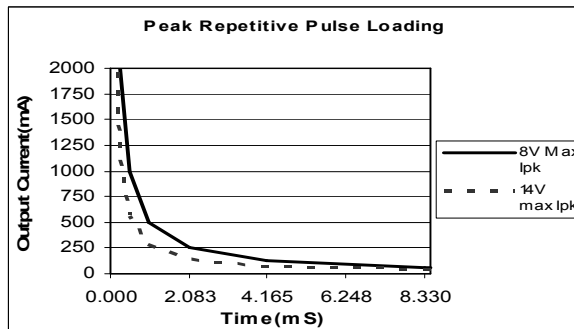
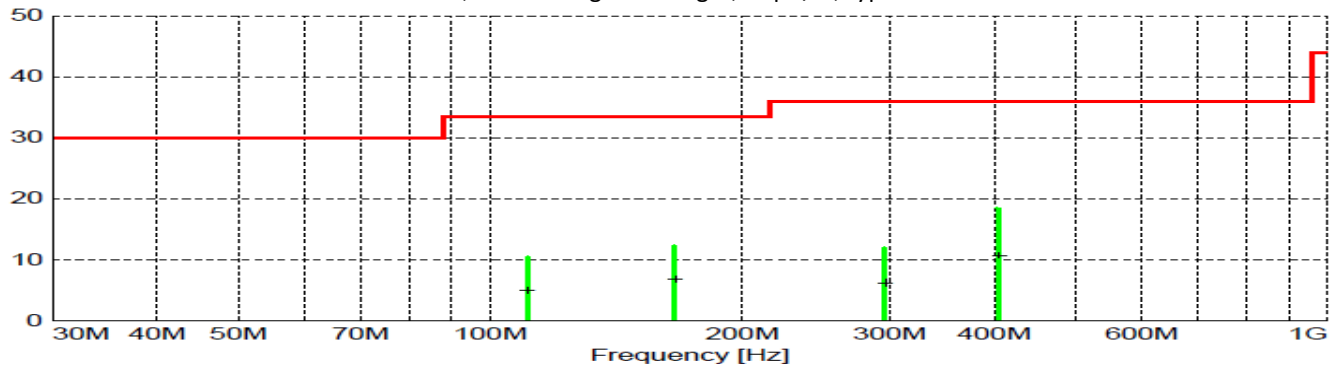



BIAS 2 Watt Power Supply BPWX 2 Series Data Sheet

Single (Vo) or Dual (Vo & Vr) output

BPWX 2-08-00, -08-33, -08-50

BPWX 2-14-00, -14-33, -14-50

BPWX 2-24-00, -24-33, -24-50

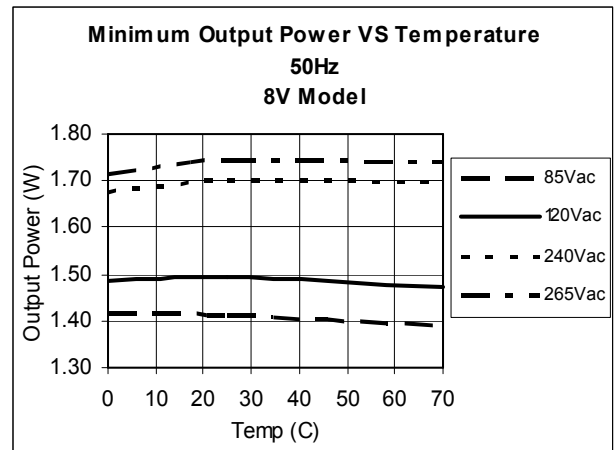
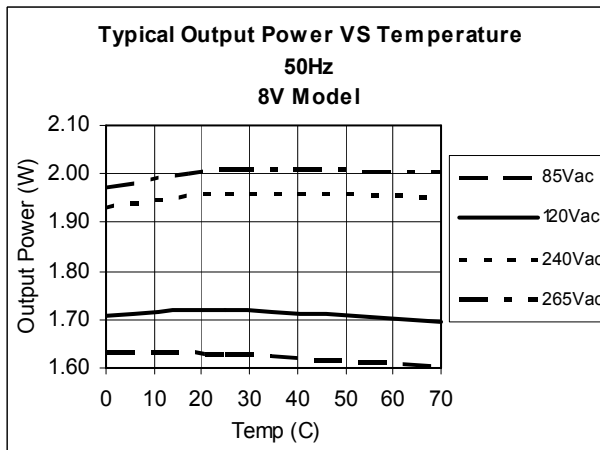
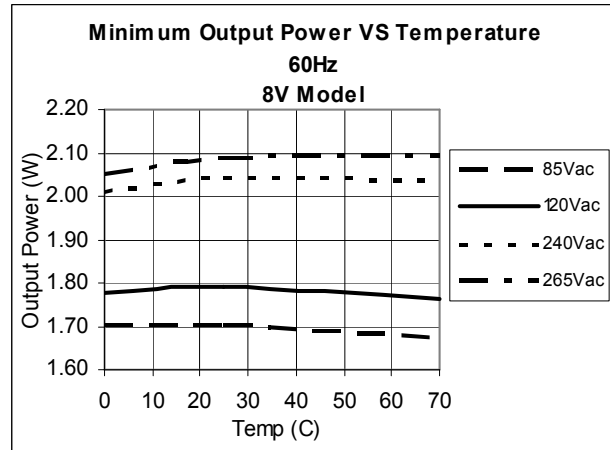
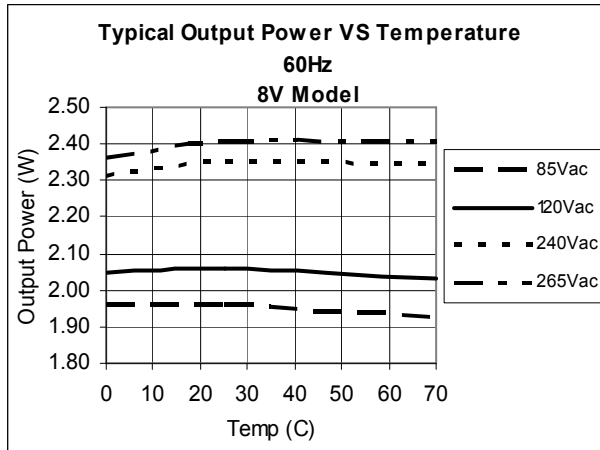



BIAS 2 Watt Power Supply BPWX 2 Series Data Sheet

Single (Vo) or Dual (Vo & Vr) output

BPWX 2-08-00, -08-33, -08-50

BPWX 2-14-00, -14-33, -14-50

BPWX 2-24-00, -24-33, -24-50

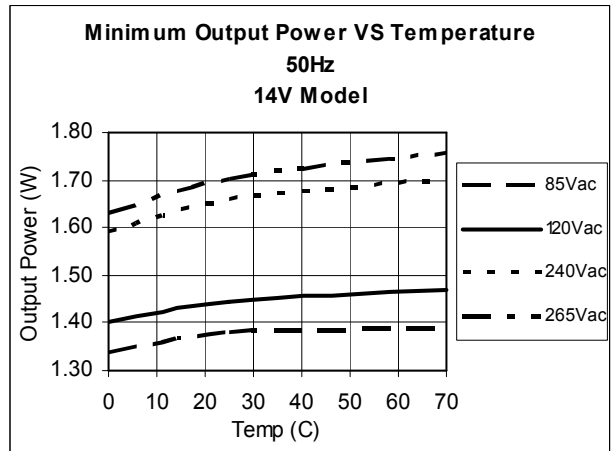
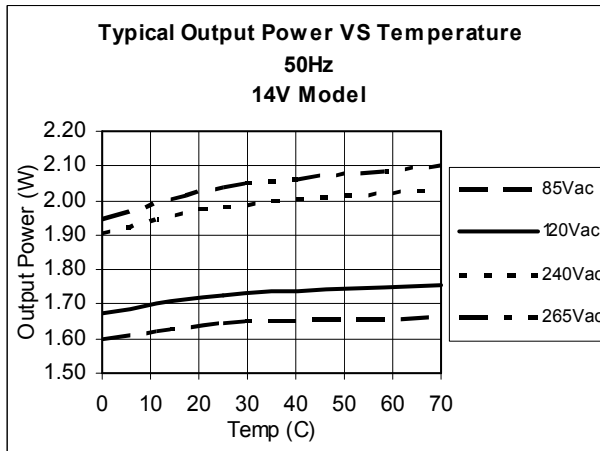
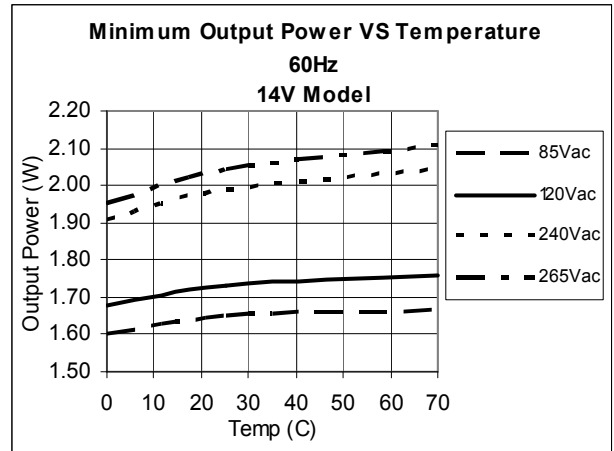
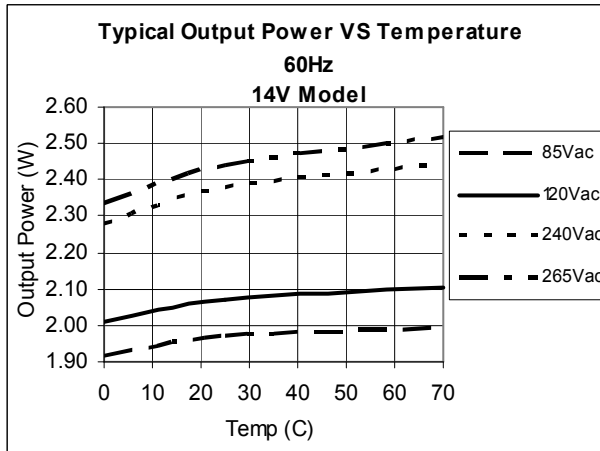



BIAS 2 Watt Power Supply

BPWX 2 Series Data Sheet

Single (Vo) or Dual (Vo & Vr) output

BPWX 2-08-00, -08-33, -08-50

BPWX 2-14-00, -14-33, -14-50

BPWX 2-24-00, -24-33, -24-50

Part Number Designation

| Part Number | Output Configuration | Vo | Vr |
|--------------|----------------------|--------|---------|
| BPWX 2-08-00 | Single output | 8 VDC | N/A |
| BPWX 2-14-00 | Single output | 14 VDC | N/A |
| BPWX 2-24-00 | Single output | 24 VDC | N/A |
| BPWX 2-08-33 | Dual Output | 8 VDC | 3.3 VDC |
| BPWX 2-08-50 | Dual Output | 8 VDC | 5 VDC |
| BPWX 2-14-33 | Dual Output | 14 VDC | 3.3 VDC |
| BPWX 2-14-50 | Dual Output | 14 VDC | 5 VDC |
| BPWX 2-24-33 | Dual Output | 24 VDC | 3.3 VDC |
| BPWX 2-24-50 | Dual Output | 24 VDC | 5.0 VDC |

For custom configurations, contact BIAS Power.

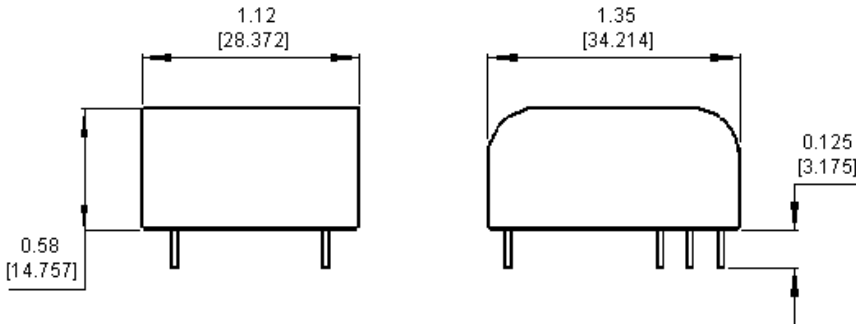

| PIN DESIGNATOR | DESCRIPTION |
|----------------|---------------|
| L1 | Input High |
| L2 | Input Low |
| N/C | No Connection |
| Vo | Output |
| GND | Ground |
| Vr | Vr Output |
| N/C | No Connection |

Isolation, Bottom View

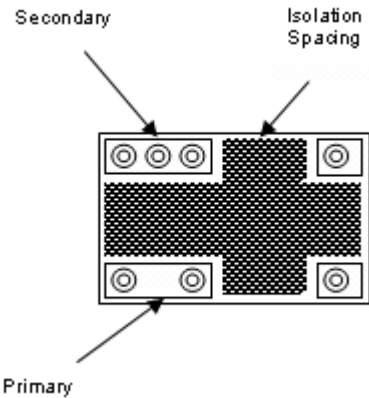

Recommended Land Pattern, top view

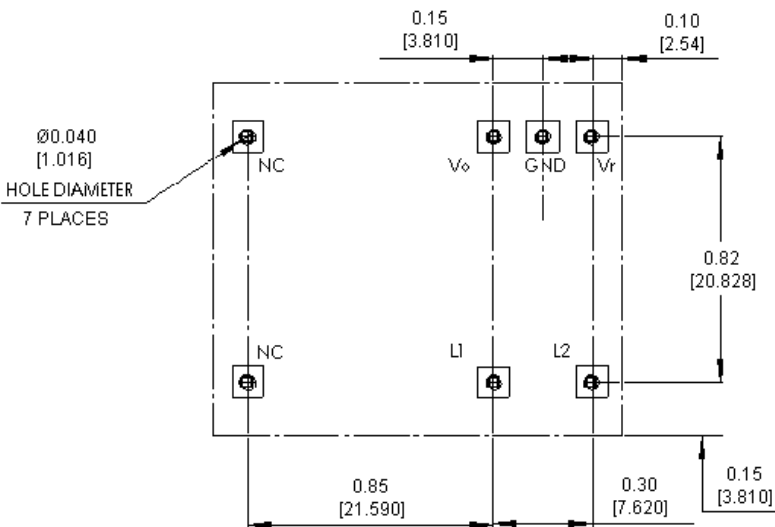

- NOTES**
1. Pins 0.031" [0.787 mm] round
 2. Pins extend 0.125" [3.175 mm] below stand-offs

Данный компонент на территории Российской Федерации

Вы можете приобрести в компании MosChip.

Для оперативного оформления запроса Вам необходимо перейти по данной ссылке:

<http://moschip.ru/get-element>

Вы можете разместить у нас заказ для любого Вашего проекта, будь то серийное производство или разработка единичного прибора.

В нашем ассортименте представлены ведущие мировые производители активных и пассивных электронных компонентов.

Нашей специализацией является поставка электронной компонентной базы двойного назначения, продукции таких производителей как XILINX, Intel (ex.ALTERA), Vicor, Microchip, Texas Instruments, Analog Devices, Mini-Circuits, Amphenol, Glenair.

Сотрудничество с глобальными дистрибьюторами электронных компонентов, предоставляет возможность заказывать и получать с международных складов практически любой перечень компонентов в оптимальные для Вас сроки.

На всех этапах разработки и производства наши партнеры могут получить квалифицированную поддержку опытных инженеров.

Система менеджмента качества компании отвечает требованиям в соответствии с ГОСТ Р ИСО 9001, ГОСТ РВ 0015-002 и ЭС РД 009

Офис по работе с юридическими лицами:

105318, г.Москва, ул.Щербаковская д.3, офис 1107, 1118, ДЦ «Щербаковский»

Телефон: +7 495 668-12-70 (многоканальный)

Факс: +7 495 668-12-70 (доб.304)

E-mail: info@moschip.ru

Skype отдела продаж:

moschip.ru

moschip.ru_4

moschip.ru_6

moschip.ru_9