

Double-Balanced Mixer 18 - 46 GHz

Rev. V2

Features

- Low Conversion Loss: 6.5 dB
- High Linearity: 20 dBm IIP3
- Wide IF Bandwidth: DC to 20 GHz
- High Isolation
- Die Size: 1.15 × 0.97 × 0.10 mm
- RoHS* Compliant

Description

MAMX-011037-DIE is a double-balanced passive diode mixer MMIC. The mixer offers low conversion loss, high linearity and a wide IF bandwidth. The double-balanced circuit configuration provides excellent port isolation while internal 50-ohm matching simplifies its application.

This mixer is well suited for applications such as test and measurement, microwave radio and radar.

MAMX-011037-DIE is also available in a 3 mm QFN package. Refer to datasheet MAMX-011054.

Functional Schematic

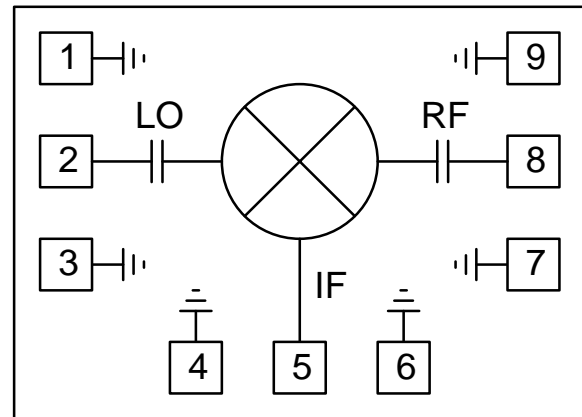

Bond-pad Configuration

Pad No.	Function	Pad No.	Function
1	GND ²	6	GND ²
2	LO	7	GND ²
3	GND ²	8	RF
4	GND ²	9	GND ²
5	IF	10	GND ³

Ordering Information

Part Number	Package
MAMX-011037-DIE	Vacuum Release Gel Pack ¹
MAMX-011037-SB2	Sample Board

1. Die quantity varies.

2. These pads are internally connected to ground, and they can be left unconnected.
3. The backside of the die must be connected to RF, DC and thermal ground.

* Restrictions on Hazardous Substances, European Union Directive 2011/65/EU.

Double-Balanced Mixer 18 - 46 GHz

Rev. V2

Electrical Specifications⁴: $F_{IF} = 1\text{GHz}$, $P_{LO} = +15\text{ dBm}$, $T_A = 25^\circ\text{C}$, $Z_0 = 50\ \Omega$

Parameter	Test Conditions	Units	Min.	Typ.	Max.
LO and RF Frequency	—	GHz	18	—	46
IF Frequency	—	GHz	0	—	20
LO Power	—	dBm	—	15	—
Conversion Loss	18 - 24 GHz	dB	—	6.5	12
	24 - 40 GHz			6.5	10
	40 - 46 GHz			6.5	11
Input P1dB	—	dBm	—	12	—
Input IP3	$P_{RF} = -10\text{ dBm/ tone}$, $\Delta f = 1\text{ MHz}$	dBm	—	20	—
Input IP2	$P_{RF} = -10\text{ dBm/ tone}$, $\Delta f = 1\text{ MHz}$	dBm	—	50	—
LO-to-RF Isolation	—	dB	—	35	—
LO-to-IF Isolation	18 - 24 GHz	dB	25	37	—
	24 - 40 GHz		27	45	
	40 - 46 GHz		23	44	
RF-to-IF Isolation	18 - 24 GHz	dB	—	10	—
	24 - 40 GHz		8	24	
	40 - 46 GHz		13	27	
RF Return Loss	RF = 40 GHz	dB	—	5	—
IF Return Loss	IF = 1 GHz	dB	—	15	—

4. All specifications refer to down-conversion operation, unless otherwise noted.

Absolute Maximum Ratings^{5,6}

Parameter	Absolute Maximum
LO Power	23 dBm
RF or IF Power	20 dBm
Junction Temperature ⁷	+150°C
Operating Temperature	-55°C to +85°C
Storage Temperature	-65°C to +150°C

5. Exceeding any one or combination of these limits may cause permanent damage to this device.
6. MACOM does not recommend sustained operation near these survivability limits.
7. Operating at nominal conditions with $T_J \leq +150^\circ\text{C}$ will ensure $\text{MTTF} > 1 \times 10^6$ hours.

Handling Procedures

Please observe the following precautions to avoid damage:

Static Sensitivity

These electronic devices are sensitive to electrostatic discharge (ESD) and can be damaged by static electricity. Proper ESD control techniques should be used when handling these HBM Class 1B devices.

2

MACOM Technology Solutions Inc. (MACOM) and its affiliates reserve the right to make changes to the product(s) or information contained herein without notice. Visit www.macom.com for additional data sheets and product information.

For further information and support please visit:
<https://www.macom.com/support>

DC-0011168

Double-Balanced Mixer 18 - 46 GHz

Rev. V2

Typical Performance Curves, $P_{LO} = +15 \text{ dBm}$, $T_A = 25^\circ\text{C}$

IF Bandwidth & Return Loss

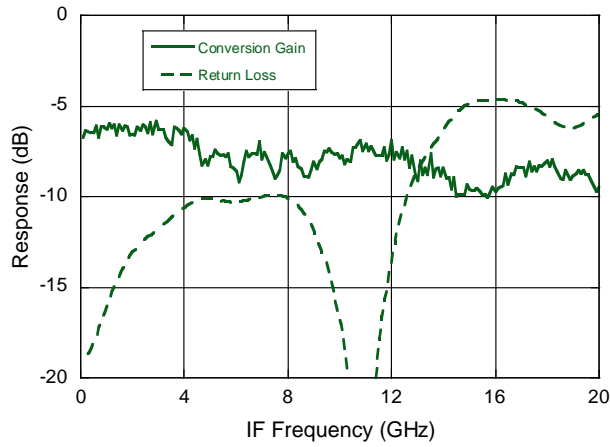

Isolation

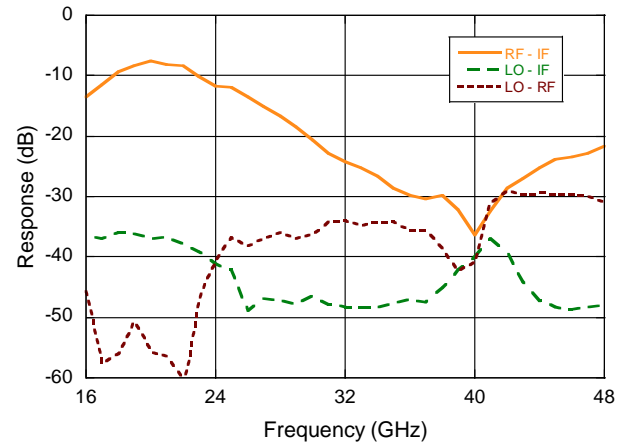

RF Return Loss

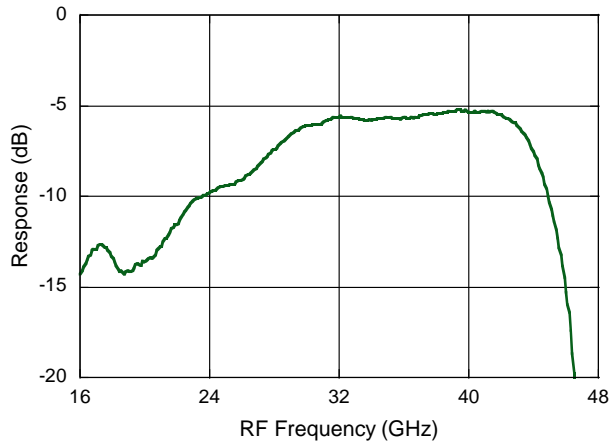

Double-Balanced Mixer 18 - 46 GHz

Rev. V2

Typical Performance Curves vs. LO Power, $T_A = 25^\circ\text{C}$

Conversion Gain

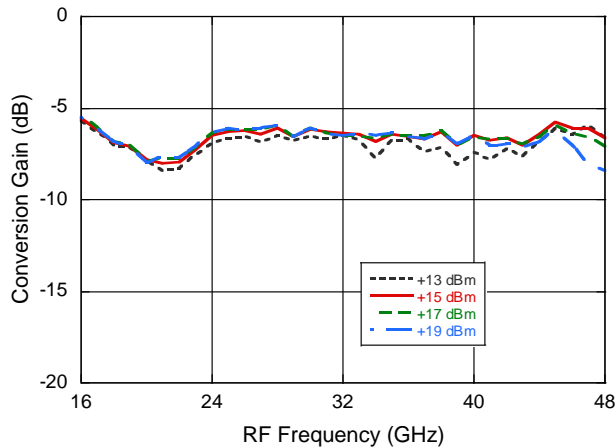

Input P1dB

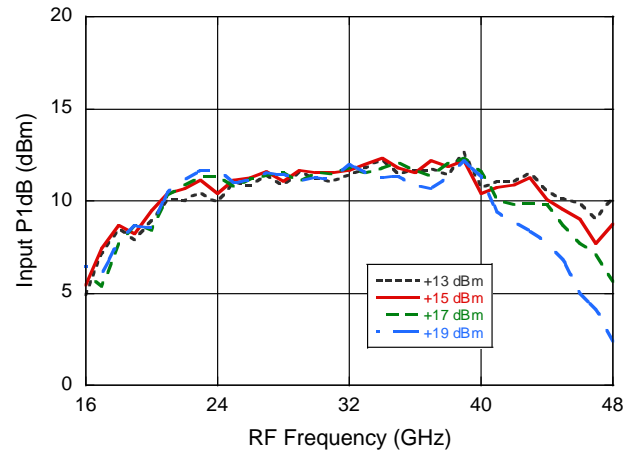

Input IP3 at $P_{LO} = +15\text{ dBm}$

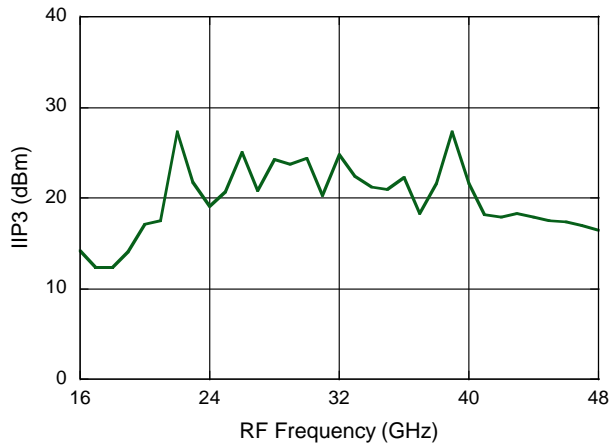

Input IP2 at $P_{LO} = +15\text{ dBm}$

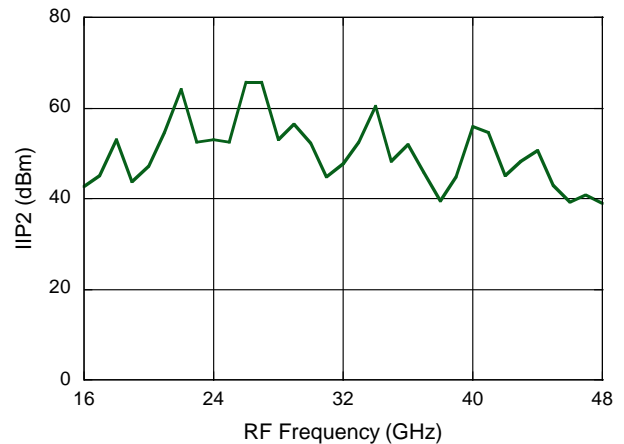

Up Conversion Gain

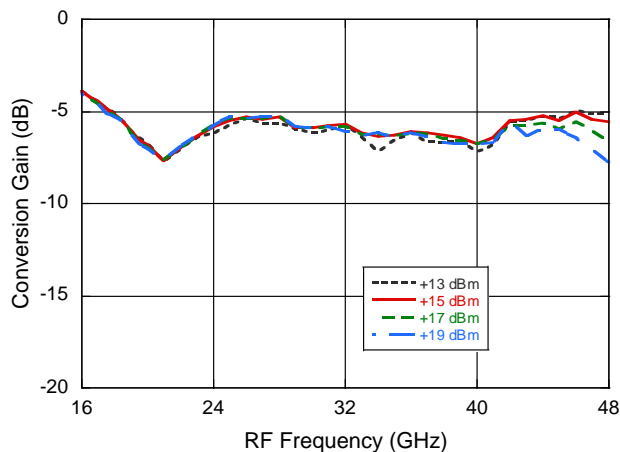

All performance curves refer to down-conversion operation, unless otherwise noted.
Two-tone input power = -10 dBm each tone, 1 MHz spacing.

Typical Performance Curves vs. Temperature, $P_{LO} = +15$ dBm

Conversion Gain

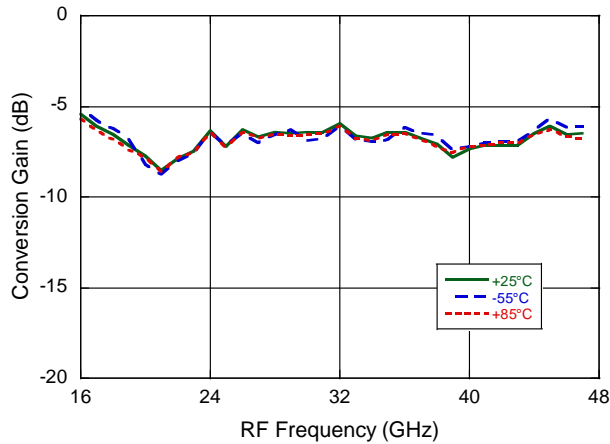

Input IP3

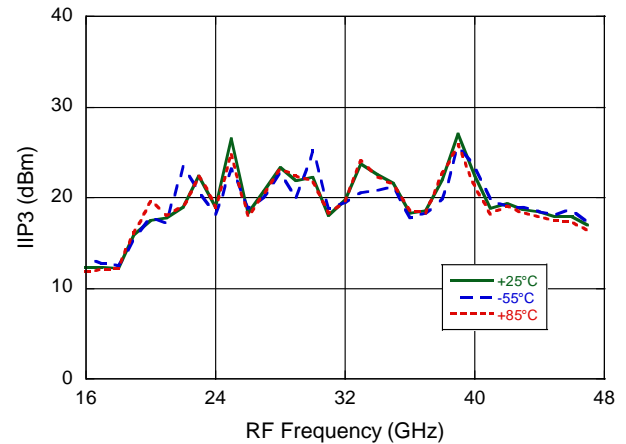

Input IP2

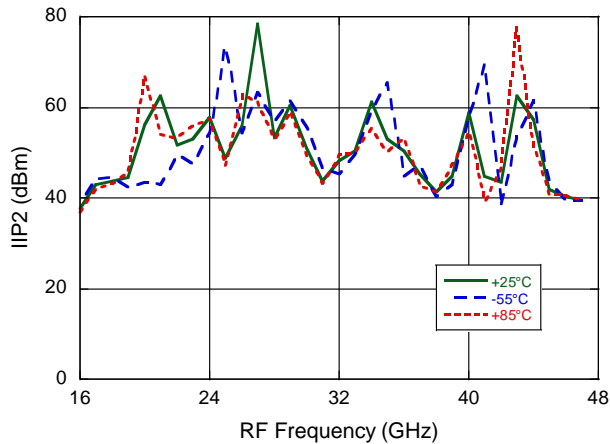

All performance curves refer to down-conversion operation, unless otherwise noted.
Two-tone input power = -10 dBm each tone, 1 MHz spacing.

Double-Balanced Mixer
18 - 46 GHz

Rev. V2

MxN Spurious Rejection @ IF Port (dBc IF)

RF = 24 GHz @ -10 dBm

LO = 25 GHz @ +15 dBm

MxRF	NxLO				
	0	1	2	3	4
0	x	14	24	x	x
1	4	0	22	x	x
2	75	61	67	66	x
3	x	86	66	71	75
4	x	x	88	99	95

Assembly Guideline

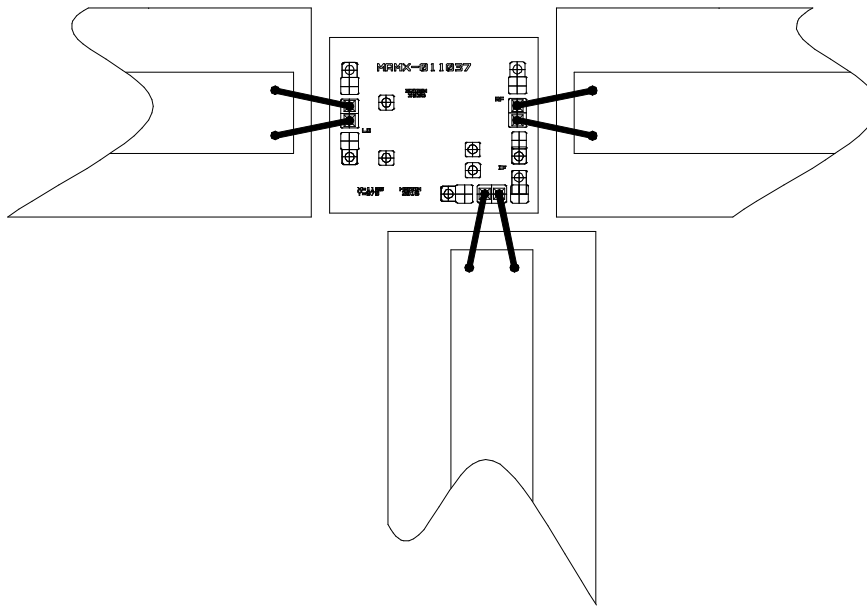

Notes:

Attach bare die to PCB or carrier using conductive epoxy. Bond die signal pads to PCB 50 Ω traces using 1.0 mil gold wire. Two bond wires are recommended on each signal pad for optimal performance. There is no need to bond the die GND pads.

MAMX-011037-DIE



Double-Balanced Mixer
18 - 46 GHz

Rev. V2

Outline Drawing

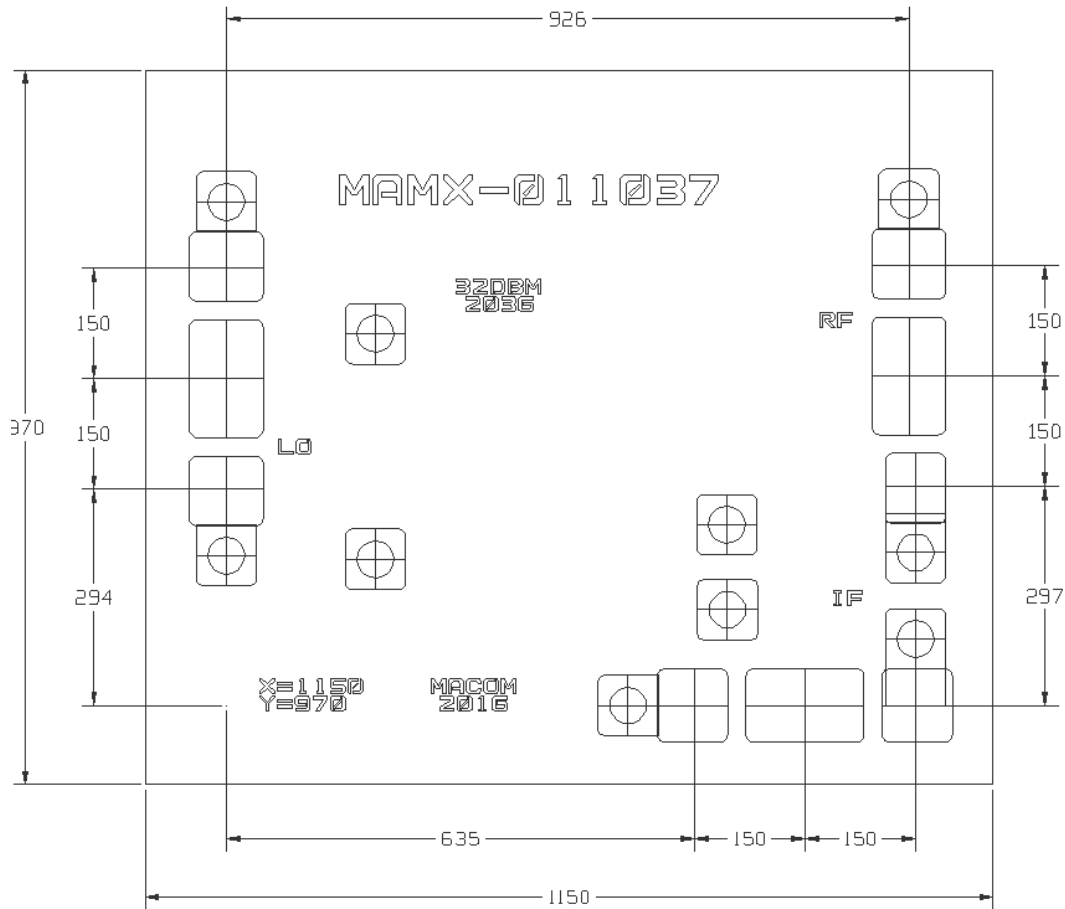

Notes:

Units are in microns with a tolerance of $\pm 5 \mu\text{m}$, except for die exterior dimensions which are street-center-to-street-center – nominal kerf, $\pm 20 \mu\text{m}$ tolerance.

Die thickness is $100 \pm 10 \mu\text{m}$.

RF, LO and IF Bond-pads are $160 \times 100 \mu\text{m}$.

MACOM Technology Solutions Inc. All rights reserved.

Information in this document is provided in connection with MACOM Technology Solutions Inc ("MACOM") products. These materials are provided by MACOM as a service to its customers and may be used for informational purposes only. Except as provided in MACOM's Terms and Conditions of Sale for such products or in any separate agreement related to this document, MACOM assumes no liability whatsoever. MACOM assumes no responsibility for errors or omissions in these materials. MACOM may make changes to specifications and product descriptions at any time, without notice. MACOM makes no commitment to update the information and shall have no responsibility whatsoever for conflicts or incompatibilities arising from future changes to its specifications and product descriptions. No license, express or implied, by estoppels or otherwise, to any intellectual property rights is granted by this document.

THESE MATERIALS ARE PROVIDED "AS IS" WITHOUT WARRANTY OF ANY KIND, EITHER EXPRESS OR IMPLIED, RELATING TO SALE AND/OR USE OF MACOM PRODUCTS INCLUDING LIABILITY OR WARRANTIES RELATING TO FITNESS FOR A PARTICULAR PURPOSE, CONSEQUENTIAL OR INCIDENTAL DAMAGES, MERCHANTABILITY, OR INFRINGEMENT OF ANY PATENT, COPYRIGHT OR OTHER INTELLECTUAL PROPERTY RIGHT. MACOM FURTHER DOES NOT WARRANT THE ACCURACY OR COMPLETENESS OF THE INFORMATION, TEXT, GRAPHICS OR OTHER ITEMS CONTAINED WITHIN THESE MATERIALS. MACOM SHALL NOT BE LIABLE FOR ANY SPECIAL, INDIRECT, INCIDENTAL, OR CONSEQUENTIAL DAMAGES, INCLUDING WITHOUT LIMITATION, LOST REVENUES OR LOST PROFITS, WHICH MAY RESULT FROM THE USE OF THESE MATERIALS.

MACOM products are not intended for use in medical, lifesaving or life sustaining applications. MACOM customers using or selling MACOM products for use in such applications do so at their own risk and agree to fully indemnify MACOM for any damages resulting from such improper use or sale.

Данный компонент на территории Российской Федерации

Вы можете приобрести в компании MosChip.

Для оперативного оформления запроса Вам необходимо перейти по данной ссылке:

<http://moschip.ru/get-element>

Вы можете разместить у нас заказ для любого Вашего проекта, будь то серийное производство или разработка единичного прибора.

В нашем ассортименте представлены ведущие мировые производители активных и пассивных электронных компонентов.

Нашей специализацией является поставка электронной компонентной базы двойного назначения, продукции таких производителей как XILINX, Intel (ex.ALTERA), Vicor, Microchip, Texas Instruments, Analog Devices, Mini-Circuits, Amphenol, Glenair.

Сотрудничество с глобальными дистрибьюторами электронных компонентов, предоставляет возможность заказывать и получать с международных складов практически любой перечень компонентов в оптимальные для Вас сроки.

На всех этапах разработки и производства наши партнеры могут получить квалифицированную поддержку опытных инженеров.

Система менеджмента качества компании отвечает требованиям в соответствии с ГОСТ Р ИСО 9001, ГОСТ РВ 0015-002 и ЭС РД 009

Офис по работе с юридическими лицами:

105318, г.Москва, ул.Щербаковская д.3, офис 1107, 1118, ДЦ «Щербаковский»

Телефон: +7 495 668-12-70 (многоканальный)

Факс: +7 495 668-12-70 (доб.304)

E-mail: info@moschip.ru

Skype отдела продаж:

moschip.ru

moschip.ru_4

moschip.ru_6

moschip.ru_9