

C&K SDA Series Low Profile DIP Switches

—
DIP



Features/Benefits

- Low profile design saves space
- Thru-hole and surface mount models
- High pressure contact does not require tape sealing
- Tape and reel packaging available
- RoHS compliant - options available

Typical Applications

- Address switch for industrial controls
- Logic switching for computers and peripherals
- Function controlling for numerous applications

How To Order

Complete part numbers for SDA Series are shown on pages I-6 through I-8. All switches supplied in "OFF" position.

Specifications

CONTACT RATING: 25 mA @ 24 V DC or 100 mA @ 50 V DC.
 MECHANICAL AND ELECTRICAL LIFE: 1,000 cycles at rated loads.
 CONTACT RESISTANCE: 50 milliohms max. initial.
 INSULATION RESISTANCE: 100 megohms between terminals.
 DIELECTRIC WITHSTANDING VOLTAGE: 300 V DC min. for 1 minute.
 STORAGE TEMPERATURE: -40°C to 85°C.
 OPERATING TEMPERATURE: -20°C to 85°C.
 OPERATING FORCE: 800 grams max.
 SOLDERABILITY: Dip and look solderability testing per C&K spec. #448. Unplated edges of terminals permitted.
 PACKAGING: Switches supplied in rigid dispensing tubes in full-tube quantities only, this may affect order quantity. Numbers of switches per tube varies with model. Tape and reel packaging also available.

Materials

HOUSING: Tin Lead, Version PPA (UL94V-0).
 RoHS, Version PPS, color black (UL94V-0).
 COVER: PPA color: Red (UL 94V-0).
 RoHS, version PPS, color black (UL94V-0).
 ACTUATOR: PA6T (UL94-0)
 CONTACTS: Gold plated Beryllium copper.
 TERMINALS: Tin lead plated brass. RoHS, gold plate over nickel plated brass.
 TAPE SEAL: Polyimide.

NOTE: For the latest information regarding RoHS compliance, please go to: www.ittcannon.com/rohs.

Note: Specifications and materials listed above are for switches with standard options. For information on specific and custom switches, consult Customer Service Center.

Flush Actuator – No Tape, Thru-hole Terminals



SDA08H0KD

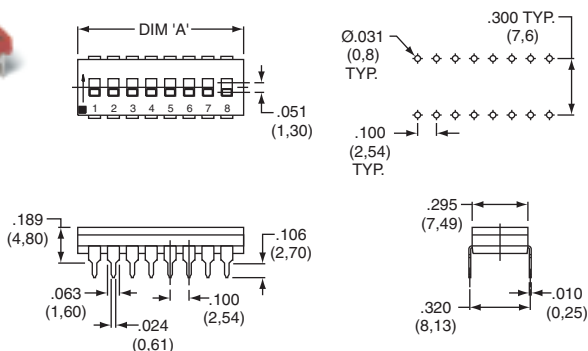

ROHS PART NUMBER	TIN LEAD PART NUMBER	NO. POS.	DIM. 'A'	QUANTITY PER TUBE
SDA01H0BD	SDA01H0KD	1	.178 (4,52)	100
SDA02H0BD	SDA02H0KD	2	.278 (7,06)	60
SDA03H0BD	SDA03H0KD	3	.378 (9,60)	45
SDA04H0BD	SDA04H0KD	4	.476 (12,10)	35
SDA05H0BD	SDA05H0KD	5	.578 (14,68)	30
SDA06H0BD	SDA06H0KD	6	.676 (17,18)	25
SDA07H0BD	SDA07H0KD	7	.778 (19,76)	20
SDA08H0BD	SDA08H0KD	8	.876 (22,26)	20
SDA09H0BD	SDA09H0KD	9	.978 (24,84)	15
SDA10H0BD	SDA10H0KD	10	1.076 (27,34)	15
SDA12H0BD	SDA12H0KD	12	1.279 (32,50)	14

Schematic

SPST



Dimensions are shown: Inch (mm)
 Specifications and dimensions subject to change



Flush Actuator – With Top Tape, Thru-hole Terminals

ROHS PART NUMBER	TIN LEAD PART NUMBER	NO. POS.	DIM. 'A'	QUANTITY PER TUBE
SDA01H0B	SDA01H0K	1	.178 (4,52)	100
SDA02H0B	SDA02H0K	2	.278 (7,06)	60
SDA03H0B	SDA03H0K	3	.378 (9,60)	45
SDA04H0B	SDA04H0K	4	.476 (12,10)	35
SDA05H0B	SDA05H0K	5	.578 (14,68)	30
SDA06H0B	SDA06H0K	6	.676 (17,18)	25
SDA07H0B	SDA07H0K	7	.778 (19,76)	20
SDA08H0B	SDA08H0K	8	.876 (22,26)	20
SDA09H0B	SDA09H0K	9	.978 (24,84)	15
SDA10H0B	SDA10H0K	10	1.076 (27,34)	15
SDA12H0B	SDA12H0K	12	1.279 (32,50)	14

Schematic

SPST

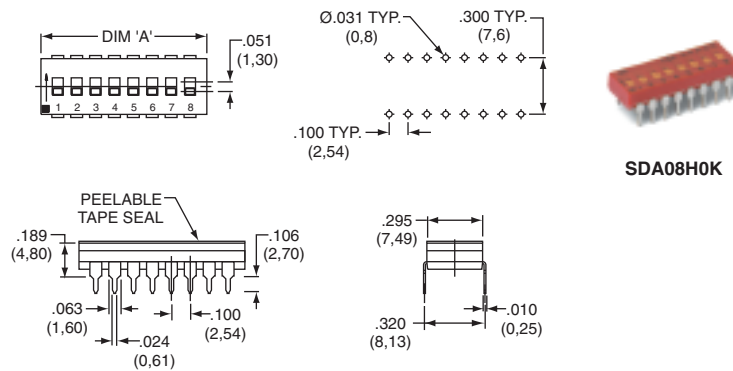

SDA08H0K

Flush Actuator – With Top Tape, Surface Mount Terminals

ROHS PART NUMBER	TIN LEAD PART NUMBER	NO. POS.	DIM. 'A'	QUANTITY PER TUBE
SDA01H0SB	SDA01H0SK	1	.178 (4,52)	100
SDA02H0SB	SDA02H0SK	2	.278 (7,06)	60
SDA03H0SB	SDA03H0SK	3	.378 (9,60)	45
SDA04H0SB	SDA04H0SK	4	.476 (12,10)	35
SDA05H0SB	SDA05H0SK	5	.578 (14,68)	30
SDA06H0SB	SDA06H0SK	6	.676 (17,18)	25
SDA07H0SB	SDA07H0SK	7	.778 (19,76)	20
SDA08H0SB	SDA08H0SK	8	.876 (22,26)	20
SDA09H0SB	SDA09H0SK	9	.978 (24,84)	15
SDA10H0SB	SDA10H0SK	10	1.076 (27,34)	15
SDA12H0SB	SDA12H0SK	12	1.279 (32,50)	14

Schematic

SPST

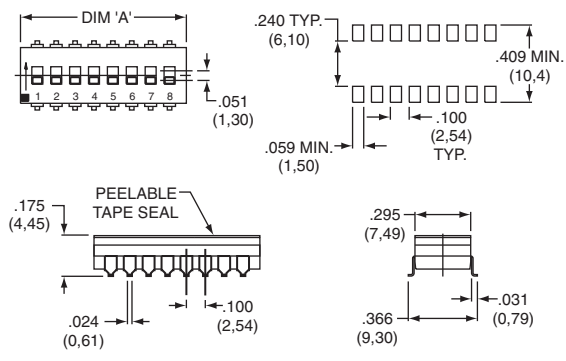

SDA08H0SK

Flush Actuator – No Tape, Surface Mount Terminals

ROHS PART NUMBER	TIN LEAD PART NUMBER	NO. POS.	DIM. 'A'	QUANTITY PER TUBE
SDA01H0SBD	SDA01H0SKD	1	.178 (4,52)	100
SDA02H0SBD	SDA02H0SKD	2	.278 (7,06)	60
SDA03H0SBD	SDA03H0SKD	3	.378 (9,60)	45
SDA04H0SBD	SDA04H0SKD	4	.476 (12,10)	35
SDA05H0SBD	SDA05H0SKD	5	.578 (14,68)	30
SDA06H0SBD	SDA06H0SKD	6	.676 (17,18)	25
SDA07H0SBD	SDA07H0SKD	7	.778 (19,76)	20
SDA08H0SBD	SDA08H0SKD	8	.876 (22,26)	20
SDA09H0SBD	SDA09H0SKD	9	.978 (24,84)	15
SDA10H0SBD	SDA10H0SKD	10	1.076 (27,34)	15
SDA12H0SBD	SDA12H0SKD	12	1.279 (32,50)	14

Schematic

SPST

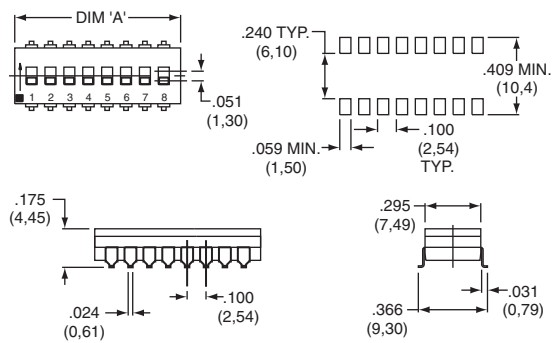

SDA08H0SKD



Dimensions are shown: Inch (mm)
Specifications and dimensions subject to change

C&K SDA Series Low Profile DIP Switches

Extended Actuator – No Top Tape, Thru-hole Terminals



ROHS PART NUMBER	TIN LEAD PART NUMBER	NO. POS.	DIM. 'A'	QUANTITY PER TUBE
SDA01H1BD	SDA01H1KD	1	.178 (4,52)	100
SDA02H1BD	SDA02H1KD	2	.278 (7,06)	60
SDA03H1BD	SDA03H1KD	3	.378 (9,60)	45
SDA04H1BD	SDA04H1KD	4	.476 (12,10)	35
SDA05H1BD	SDA05H1KD	5	.578 (14,68)	30
SDA06H1BD	SDA06H1KD	6	.676 (17,18)	25
SDA07H1BD	SDA07H1KD	7	.778 (19,76)	20
SDA08H1BD	SDA08H1KD	8	.876 (22,26)	20
SDA09H1BD	SDA09H1KD	9	.978 (24,84)	15
SDA10H1BD	SDA10H1KD	10	1.076 (27,34)	15
SDA12H1BD	SDA12H1KD	12	1.279 (32,50)	14

Schematic

SPST

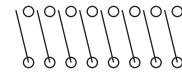

Extended Actuator – No Top Tape, Surface Mount Terminals



ROHS PART NUMBER	TIN LEAD PART NUMBER	NO. POS.	DIM. 'A'	QUANTITY PER TUBE
SDA01H1SBD	SDA01H1SKD	1	.178 (4,52)	100
SDA02H1SBD	SDA02H1SKD	2	.278 (7,06)	60
SDA03H1SBD	SDA03H1SKD	3	.378 (9,60)	45
SDA04H1SBD	SDA04H1SKD	4	.476 (12,10)	35
SDA05H1SBD	SDA05H1SKD	5	.578 (14,68)	30
SDA06H1SBD	SDA06H1SKD	6	.676 (17,18)	25
SDA07H1SBD	SDA07H1SKD	7	.778 (19,76)	20
SDA08H1SBD	SDA08H1SKD	8	.876 (22,26)	20
SDA09H1SBD	SDA09H1SKD	9	.978 (24,84)	15
SDA10H1SBD	SDA10H1SKD	10	1.076 (27,34)	15
SDA12H1SBD	SDA12H1SKD	12	1.279 (32,50)	14

Schematic

SPST

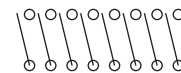

Tape & Reel Packaging – Surface Mount Options only

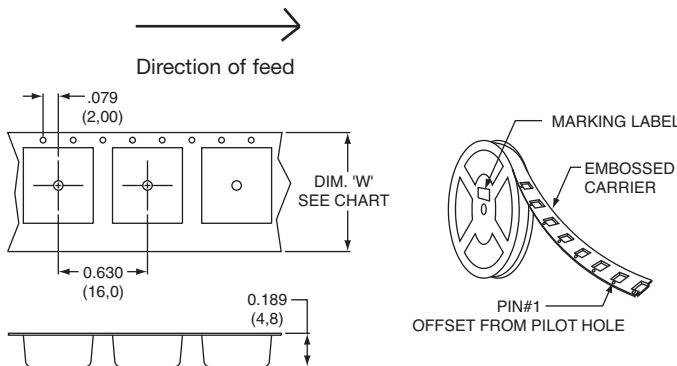

ROHS PART NUMBER	TIN LEAD PART NUMBER	DIM. 'W'	QUANTITY PER TUBE
SDA01H0SBR	SDA01H0SKR	.945 (24,0)	1500
SDA02H0SBR	SDA02H0SKR	.945 (24,0)	750
SDA03H0SBR	SDA03H0SKR	.945 (24,0)	750
SDA04H0SBR	SDA04H0SKR	.945 (24,0)	750
SDA05H0SBR	SDA05H0SKR	.945 (24,0)	750
SDA06H0SBR	SDA06H0SKR	1.26 (32,0)	750
SDA07H0SBR	SDA07H0SKR	1.26 (32,0)	750
SDA08H0SBR	SDA08H0SKR	1.73 (44,0)	750
SDA09H0SBR	SDA09H0SKR	1.73 (44,0)	750
SDA10H0SBR	SDA10H0SKR	1.73 (44,0)	750
SDA12H0SBR	SDA12H0SKR	1.73 (44,0)	750

Schematic

SPST

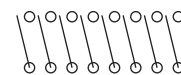

Third Angle Projection

Dimensions are shown: Inch (mm)
Specifications and dimensions subject to change



Данный компонент на территории Российской Федерации

Вы можете приобрести в компании MosChip.

Для оперативного оформления запроса Вам необходимо перейти по данной ссылке:

<http://moschip.ru/get-element>

Вы можете разместить у нас заказ для любого Вашего проекта, будь то серийное производство или разработка единичного прибора.

В нашем ассортименте представлены ведущие мировые производители активных и пассивных электронных компонентов.

Нашей специализацией является поставка электронной компонентной базы двойного назначения, продукции таких производителей как XILINX, Intel (ex.ALTERA), Vicor, Microchip, Texas Instruments, Analog Devices, Mini-Circuits, Amphenol, Glenair.

Сотрудничество с глобальными дистрибьюторами электронных компонентов, предоставляет возможность заказывать и получать с международных складов практически любой перечень компонентов в оптимальные для Вас сроки.

На всех этапах разработки и производства наши партнеры могут получить квалифицированную поддержку опытных инженеров.

Система менеджмента качества компании отвечает требованиям в соответствии с ГОСТ Р ИСО 9001, ГОСТ РВ 0015-002 и ЭС РД 009

Офис по работе с юридическими лицами:

105318, г.Москва, ул.Щербаковская д.3, офис 1107, 1118, ДЦ «Щербаковский»

Телефон: +7 495 668-12-70 (многоканальный)

Факс: +7 495 668-12-70 (доб.304)

E-mail: info@moschip.ru

Skype отдела продаж:

moschip.ru

moschip.ru_4

moschip.ru_6

moschip.ru_9