PWM/VFM Step-down DC/DC Controller

NO.EA-097-181004

OUTLINE

The R1225N is a CMOS-based PWM step-down DC/DC converter controller with low supply current. It consists of an oscillator, a PWM control circuit, a reference voltage unit, an error amplifier, a soft-start circuit, a latch-type protection circuit, a PWM/VFM alternative circuit, a chip enable circuit, a phase compensation circuit, and an input voltage detect circuit. Further, protection circuit delay time adjuster circuit, and resistors for voltage detection are included. A low ripple, high efficiency step-down DC/DC converter can be easily composed of this IC with some external components, or a power-transistor, an inductor, a diode and capacitors. With a PWM/VFM alternative circuit, when the load current is small, the operation is automatically switching into the VFM oscillator from PWM oscillator, therefore the efficiency at small load current is improved. The R1225NxxxC/D/K types, which are without a PWM/VFM alternative circuit, are also available.

If the term of maximum duty cycle keeps on a certain time, the embedded protection circuit works. It is latch-type protection circuit, and it works to latch an external Power MOSFET with keeping it off. To release the condition of protection, after disable this IC with a chip enable circuit, enable it again, or restart this IC with power-on. Delay Time for protection circuit is adjustable with an external capacitor. With a built-in UVLO function, when the input voltage is UVLO threshold or less, this IC keeps standby state, and saves its consumption current and avoids miss-operation. Further, if the set output voltage is equal or more than 2.1 V, with a built-in start-up function, at the power-on moment until the input voltage becomes more than the set output voltage, DC/DC operation is halted and avoids miss-operation.

FEATURES

- Wide Range of Input Voltage 2.3 V to 18.5 V
- Built-in Soft-start and Latch-type Protection
- Three Options of Oscillator Frequency 180 kHz, 300 kHz, 500 kHz
- High Efficiency Typ. 90%
- Output Voltage 1.2 V to 6.0 V, 0.1 V step
- Standby Current Typ. 0.0 μ A
- High Accuracy Output Voltage $\pm 2.0\%$
- Low Temperature-Drift Coefficient of Output Voltage Typ. ± 100 ppm/ $^{\circ}$ C

APPLICATIONS

- Hand-held Communication Equipment, Cameras, VCRs, Camcorders
- Battery-powered Equipment
- Household Electrical Appliances

R1225N

NO.EA-097-181004

BLOCK DIAGRAM

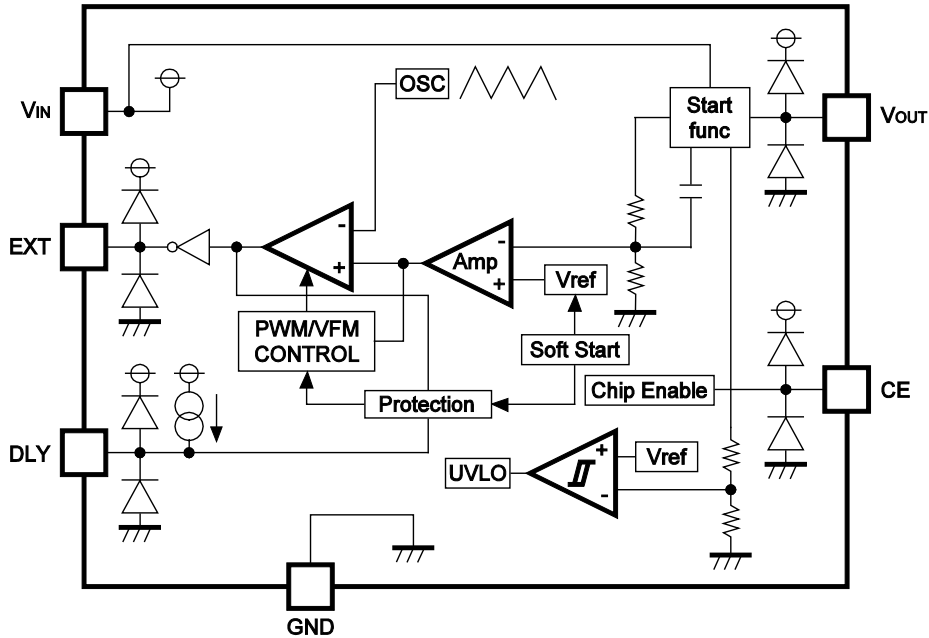

R1225N Block Diagram

SELECTION GUIDE

The output voltage, the oscillator frequency and the PWM/VFM alternative circuit are user-selectable options.

Selection Guide

Product Name	Package	Quantity per Reel	Pb Free	Halogen Free
R1225Nxx2*-TR-FE	SOT-23-6W	3,000 pcs	Yes	Yes

xx: The output voltage can be designed in the range from 1.2 V (12) to 6.0 V (60) in 0.1 V steps.

*: The oscillator frequency and the modulation method are options as follows.

*	Oscillator Frequency	PWM/VFM Alternative Circuit
A	300 kHz	Yes
B	500 kHz	Yes
C	300 kHz	No
D	500 kHz	No
J	180 kHz	Yes
K	180 kHz	No

PIN DESCRIPTIONS



R1225N (SOT-23-6W) Pin Configuration

Pin Description

Pin No.	Symbol	Description
1	EXT	External Transistor Drive Pin, CMOS Output Type
2	VIN	Power Supply Pin
3	DLY	Pin for Setting External Capacitor for Protection Circuit Delay Time
4	CE	Chip Enable Pin, Active-high
5	GND	Ground Pin
6	VOUT	Pin for Monitoring Output Voltage

R1225N

NO.EA-097-181004

ABSOLUTE MAXIMUM RATINGS**Absolute Maximum Ratings**

(GND = 0 V)

Symbol	Item	Rating	Unit
V _{IN}	VIN Supply Voltage	20	V
V _{EXT}	EXT Pin Output Voltage	-0.3 to V _{IN} +0.3	V
V _{CE}	CE Pin Input Voltage	-0.3 to V _{IN} +0.3	V
V _{OUT}	VOUT Pin Input Voltage	-0.3 to V _{IN} +0.3	V
V _{DLY}	VDLY Pin Input Voltage	-0.3 to 1.0	V
I _{EXT}	EXT Pin Inductor Drive Output Current	±50	mA
I _{DLY}	DLY Pin Output Current	±15	mA
P _D	Power Dissipation	430	mW
T _j	Junction Temperature Range	-40 to 125	°C
T _{stg}	Storage Temperature Range	-55 to 125	°C

ABSOLUTE MAXIMUM RATINGS

Electronic and mechanical stress momentarily exceeded absolute maximum ratings may cause the permanent damages and may degrade the lifetime and safety for both device and system using the device in the field. The functional operation at or over these absolute maximum ratings is not assured.

RECOMMENDED OPERATING CONDITIONS**Recommended Operating Conditions**

Symbol	Item	Rating	Unit
V _{IN}	Input Voltage	2.3 to 18.5	V
T _a	Operating Temperature Range	-40 to 85	°C

RECOMMENDED OPERATING CONDITIONS

All of electronic equipment should be designed that the mounted semiconductor devices operate within the recommended operating conditions. The semiconductor devices cannot operate normally over the recommended operating conditions, even if when they are used over such conditions by momentary electronic noise or surge. And the semiconductor devices may receive serious damage when they continue to operate over the recommended operating conditions.

ELECTRICAL CHARACTERISTICS

R1225Nxx2X Electrical Characteristics (X = A/ B/ C/ D/ J/ K)

(Ta = 25°C)

Symbol	Item	Conditions	Min.	Typ.	Max.	Unit
V _{OUT}	Step-down Output Voltage	V _{IN} = V _{CE} = V _{SET} + 1.5 V, I _{OUT} = -100 mA When V _{SET} ≤ 1.5 V, V _{IN} = V _{CE} = 3.0 V	V _{SET} ×0.98	V _{SET}	V _{SET} ×1.02	V
ΔV _{OUT} / ΔTa	Step-down Output Voltage Temperature Coefficient	-40°C ≤ Ta ≤ 85°C		±100		ppm/ °C
f _{OSC}	Oscillator Frequency	V _{IN} = V _{CE} = V _{SET} + 1.5 V, I _{OUT} = -100 mA When V _{SET} ≤ 1.5 V, V _{IN} = V _{CE} = 3.0 V J/ K version A/ C version B/ D version	144 240 400	180 300 500	216 360 600	kHz
Δf _{OSC} / ΔTa	Oscillator Frequency Temperature Coefficient	-40°C ≤ Ta ≤ 85°C		±0.2		%/ °C
I _{DD1}	Supply Current 1	V _{IN} = V _{CE} = V _{OUT} = 18.5 V A/ B/ J/ K version C version D version		20 30 40	50 60 80	μA
I _{STANDBY}	Standby Current	V _{IN} = 18.5 V, V _{CE} = 0 V, V _{OUT} = 0 V		0.0	0.5	μA
I _{EXTH}	EXT "H" Output Current	V _{IN} = 8 V, V _{EXT} = 7.9 V, V _{OUT} = 8 V, V _{CE} = 8 V		-17	-10	mA
I _{EXTL}	EXT "L" Output Current	V _{IN} = 8 V, V _{EXT} = 0.1 V, V _{OUT} = 0 V, V _{CE} = 8 V	20	30		mA
I _{SW}	DLY switch current	V _{IN} = 2.3 V, V _{CE} = 0 V, V _{DLY} = 0.1 V	1.0	2.0		mA
I _{CEH}	CE "H" Input Current	V _{IN} = V _{CE} = V _{OUT} = 18.5 V		0.0	0.5	μA
I _{CEL}	CE "L" Input Current	V _{IN} = V _{OUT} = 18.5 V, V _{CE} = 0 V	-0.5	0.0		μA
V _{CEH}	CE "H" Input Voltage	V _{IN} = 8 V, V _{OUT} = 0 V	1.5			V
V _{CEL}	CE "L" Input Voltage	V _{IN} = 8 V, V _{OUT} = 0 V			0.3	V
D _{MAX}	Oscillator Maximum Duty Cycle		100			%
D _{VFM}	VFM Duty Cycle	A/ B/ J version		35		%
V _{UVLO1}	UVLO Voltage	V _{OUT} = 0 V, V _{IN} = V _{CE} = 2.5 V → 1.5 V	1.8	2.0	2.2	V
V _{UVLO2}	UVLO Release Voltage	V _{OUT} = 0 V, V _{IN} = V _{CE} = 1.5 V → 2.5 V		V _{UVLO1} +0.1	2.3	V
t _{START}	Soft-start Time	V _{IN} = V _{SET} + 1.5 V, I _{OUT} = -10 mA V _{CE} = 0 V → V _{SET} + 1.5 V	5	10	20	ms
t _{PROT}	Protection Delay Time	V _{IN} = V _{CE} = V _{SET} + 1.5 V V _{OUT} = V _{SET} + 1.5 V → 0 V	10	20	35	ms

TYPICAL APPLICATION AND APPLICATION HINTS

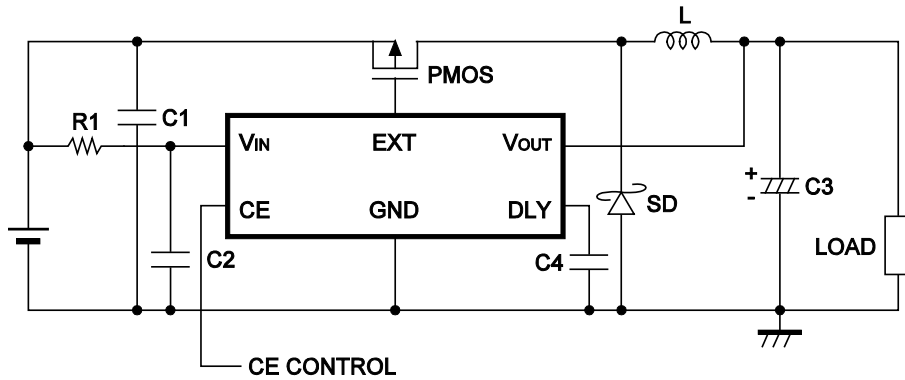

Typical Application

External Components

Symbol	Description
PMOS	uPA1914, Renesas
L	CR105NP-270MC, Sumida
SD	CMS06, Toshiba
C1	10 μ F, Ceramic Type
C2	0.1 μ F, Ceramic Type
C3	47 μ F, Tantalum Type
C4	0.02 μ F, Ceramic Type
R1	10 Ω

TECHNICAL NOTES

- As shown in the block diagram, a parasitic diode is formed in each terminal, each of these diodes is not formed for load current, therefore do not use it in such a way. When you control the CE pin by another power supply, do not make its "H" level more than the voltage level of VIN pin.
- The operation of Latch-type protection circuit is as follows;
When the maximum duty cycle continues longer than the delay time for protection circuit, (Refer to the Electrical Characteristics) the protection circuit works to shutdown Power MOSFET with latching operation. Therefore when an input/output voltage difference is small, the protection circuit may work with small load current.
To release the protection of latch status, after disable this IC with a chip enable circuit, enable it again, or restart this IC with power-on. However, in the case of restarting this IC with power-on, after the power supply is turned off, if a certain amount of charge remains in C_{IN}, or some voltage is forced to V_{IN} from C_{IN}, this IC might not be restarted even after power-on.
- Set external components as close as possible to the IC and minimize the connection between the components and the IC. In particular, a capacitor should be connected to V_{OUT} pin with the minimum connection. Make grounding sufficient and reinforce supplying. Large switching current flows through the connection of power line, an inductor and the connection of V_{OUT}. If the impedance of the connection of power supply is high, the voltage level of power supply of the IC fluctuates with the switching current. This may cause unstable operation of the IC.
- Use capacitors with a capacity of 22 μF or more for V_{OUT} pin, and with good high frequency characteristics such as tantalum capacitors. We recommend to use capacitors with an allowable voltage which is at least twice as much as setting output voltage, in terms of the input capacitors, its voltage rating is twice or more than input voltage. This is because there may be a case where a spike-shaped high voltage is generated by an inductor when an external transistor is on and off.
- Choose an inductor that has sufficiently small D.C. resistance and large allowable current and is hard to reach magnetic saturation. If the value of inductance of an inductor is extremely small, the I_{LX} may exceed the absolute maximum rating at the maximum loading. Use an inductor with appropriate inductance.
- Use a diode of a Schottky type with high switching speed, and also pay attention to its current capacity.
- Do not use this IC under the condition with V_{IN} voltage at equal or less than minimum operating voltage.
- When the threshold level of an external power MOSFET is rather low and the drive-ability of voltage supplier is small, if the output pin is short circuit, input voltage may be equal or less than UVLO detector threshold. In this case, the device is reset with UVLO function that is not the latch-protection function.
- With the PWM/VFM alternative circuit, when the on duty cycle of switching is 35% or less, the R1225N alters from PWM mode to VFM mode (Pulse skip mode). The purpose of this circuit is raising the efficiency with a light load by skipping the frequency and suppressing the consumption current. However, the ratio of output voltage against input voltage is 35% or less, (ex. V_{IN} > 8.6 V and V_{OUT} = 3.0 V) even if the large current may be loaded, the IC keeps its VFM mode. As a result, frequency might be decreased, and oscillation waveform might be unstable. These phenomena are the typical characteristics of the IC with PWM/VFM alternative circuit.
- ★ The performance of a power source circuit using this device is highly dependent on a peripheral circuit. A peripheral component or the device mounted on PCB should not exceed its rated voltage, rated current or rated power. When designing a peripheral circuit, please be fully aware of the following points.

HOW TO SET THE DELAY TIME FOR PROTECTION CIRCUIT

The equation describes how to calculate the delay time of protection circuit from the value of an external capacitor C4.

$$t_{DLY} = C4 \times 10^6 \text{sec (in this equation, } 1 \mu\text{F} \geq C4 \geq 1000 \text{ pF)}$$

Without the external capacitor, a certain delay time exists, therefore, if the external capacitor is less than 1000 pF, the error will increase. Further, if the external capacitor value is beyond 1 μF , the time required to discharge the C4 will be long, and this may cause the miss-operation. For example, if the protection circuit may work and released, soon after that the protection may work. In that case, C4 has not discharged completely yet, therefore, the delay time may be shorter than expected.

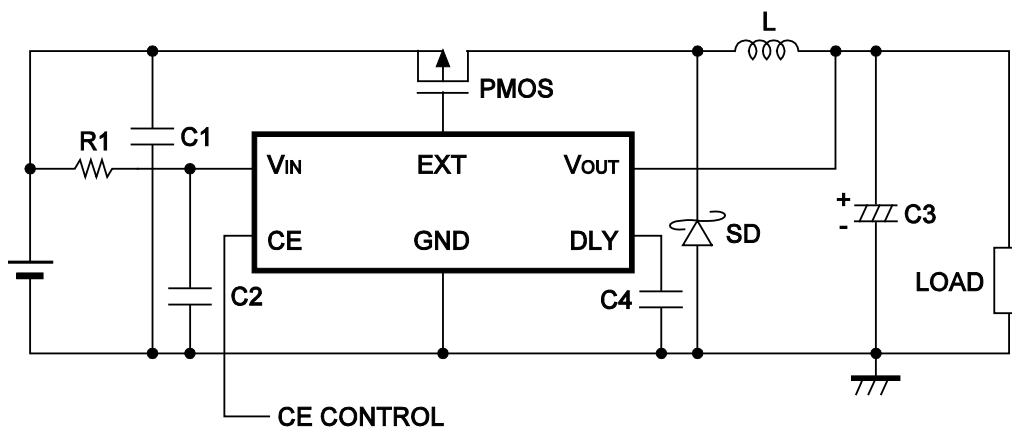

OPERATION OF STEO-DOWN DC/DC CONVERTER AND OUTPUT CURRENT

The step-down DC/DC converter charges energy in the inductor when Lx transistor is ON, and discharges the energy from the inductor when Lx transistor is OFF and controls with less energy loss, so that a lower output voltage than the input voltage is obtained. The operation will be explained with reference to the following diagrams:

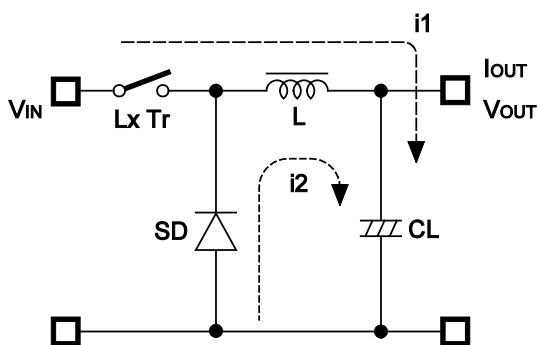

Basic Circuits

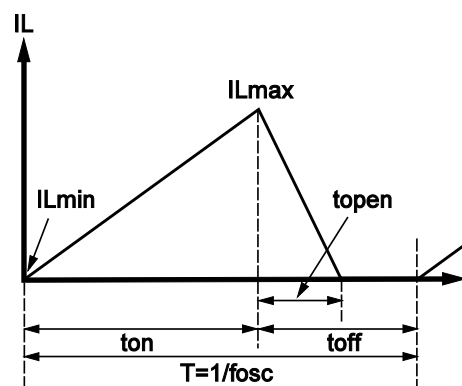

Current through L

- Step 1: Lx Tr. turns on and current $I_L (= i_1)$ flows, and energy is charged into CL. At this moment, I_L increases from $I_{Lmin} (= 0)$ to reach I_{Lmax} in proportion to the on-time period (t_{on}) of LX Tr.
- Step 2: When Lx Tr. turns off, Schottky diode (SD) turns on in order that L maintains I_L at I_{Lmax} , and current $I_L (= i_2)$ flows.
- Step 3: I_L decreases gradually and reaches I_{Lmin} after a time period of t_{open} , and SD turns off, provided that in the continuous mode, next cycle starts before I_L becomes to 0 because t_{off} time is not enough. In this case, I_L value is from this $I_{Lmin} (> 0)$.

In the case of PWM control system, the output voltage is maintained by controlling the on-time period (t_{on}), with the oscillator frequency (f_{osc}) being maintained constant.

Discontinuous Conduction Mode and Continuous Conduction Mode

The maximum value (I_{Lmax}) and the minimum value (I_{Lmin}) current which flow through the inductor is the same as those when $Lx Tr.$ turns on and when it turns off.

The difference between I_{Lmax} and I_{Lmin} , which is represented by ΔI ;

$$\Delta I = I_{Lmax} - I_{Lmin} = V_{OUT} \times t_{open} / L = (V_{IN} - V_{OUT}) \times t_{on} / L \dots\dots\dots \text{Equation 1}$$

Where, $T = 1 / f_{OSC} = t_{on} + t_{off}$

$$\text{Duty (\%)} = t_{on} / T \times 100 = t_{on} \times f_{OSC} \times 100$$

$$t_{open} \leq t_{off}$$

In Equation 1, $V_{OUT} \times t_{open} / L$ and $(V_{IN} - V_{OUT}) \times t_{on} / L$ are respectively shown the change of the current at ON, and the change of the current at OFF.

When the output current (I_{OUT}) is relatively small, $t_{open} < t_{off}$ as illustrated in the above diagram. In this case, the energy is charged in the inductor during the time period of t_{on} and is discharged in its entirety during the time period of t_{off} , therefore I_{Lmin} becomes to zero ($I_{Lmin} = 0$). When I_{OUT} is gradually increased, eventually, t_{open} becomes to t_{off} ($t_{open} = t_{off}$), and when I_{OUT} is further increased, I_{Lmin} becomes larger than zero ($I_{Lmin} > 0$). The former mode is referred to as the discontinuous mode and the latter mode is referred to as continuous mode.

In the continuous mode, when Equation 1 is solved for t_{on} and assumed that the solution is t_{onc} ,

$$t_{onc} = T \times V_{OUT} / V_{IN} \dots\dots\dots \text{Equation 2}$$

When $t_{on} < t_{onc}$, the mode is the discontinuous mode, and when $t_{on} = t_{onc}$, the mode is the continuous mode.

OUTPUT CURRENT AND SELECTION OF EXTERNAL COMPONENTS

When Lx Tr. is "ON":

(Wherein, Ripple Current P-P value is described as I_{RP} , ON resistance of LX Tr. is described as R_P the direct current of the inductor is described as R_L .)

$$V_{IN} = V_{OUT} + (R_P + R_L) \times I_{OUT} + L \times I_{RP} / t_{on} \dots \dots \dots \text{Equation 3}$$

When Lx Tr. is "OFF":

$$L \times I_{RP} / t_{off} = V_F + V_{OUT} + R_L \times I_{OUT} \dots \dots \dots \text{Equation 4}$$

Put Equation 4 to Equation 3 and solve for ON duty, $t_{on} / (t_{off} + t_{on}) = D_{ON}$,

$$D_{ON} = (V_{OUT} + V_F + R_L \times I_{OUT}) / (V_{IN} + V_F - R_P \times I_{OUT}) \dots \dots \dots \text{Equation 5}$$

Ripple Current is as follows;

$$I_{RP} = (V_{IN} - V_{OUT} - R_P \times I_{OUT} - R_L \times I_{OUT}) \times D_{ON} / f / L \dots \dots \dots \text{Equation 6}$$

Wherein, peak current that flows through L, Lx Tr., and SD is as follows;

$$I_{Lmax} = I_{OUT} + I_{RP} / 2 \dots \dots \dots \text{Equation 7}$$

Consider I_{Lmax} , condition of input and output and select external components.

★The above explanation is directed to the calculation in an ideal case in continuous mode.

EXTERNAL COMPONENTS

1. Inductor

Select an inductor that peak current does not exceed I_{Lmax} . If larger current than allowable current flows, magnetic saturation occurs and make transform efficiency worse. When the load current is definite, the smaller value of L, the larger the ripple current. Provided that the allowable current is large in that case and DC current is small, therefore, for large output current, efficiency is better than using an inductor with a large value of L and vice versa.

2. Diode

Use a diode with low V_F (Schottky type is recommended.) and high switching speed. Reverse voltage rating should be more than V_{IN} and current rating should be equal or more than I_{Lmax} .

3. Capacitors

As for C_{IN} , use a capacitor with low ESR (Equivalent Series Resistance) and a capacity of at least 10 μF for stable operation. C_{OUT} can reduce ripple of Output Voltage, therefore 47 μF or more value of tantalum type capacitor is recommended.

4. Lx Transistor

Pch Power MOSFET is required for this IC. Its breakdown voltage between gate and source should be a few V higher than Input Voltage. In the case of Input Voltage is low, to turn on MOSFET completely, to use a MOSFET with low threshold voltage is effective. If a large load current is necessary for your application and important, choose a MOSFET with low ON resistance for good efficiency. If a small load current is mainly necessary for your application, choose a MOSFET with low gate capacity for good efficiency. Maximum continuous drain current of MOSFET should be larger than peak current, I_{Lmax} .

TIMING CHART

Case 1. Set V_{OUT} Voltage > 2.1 V (Set V_{OUT} Voltage > UVLO Voltage)

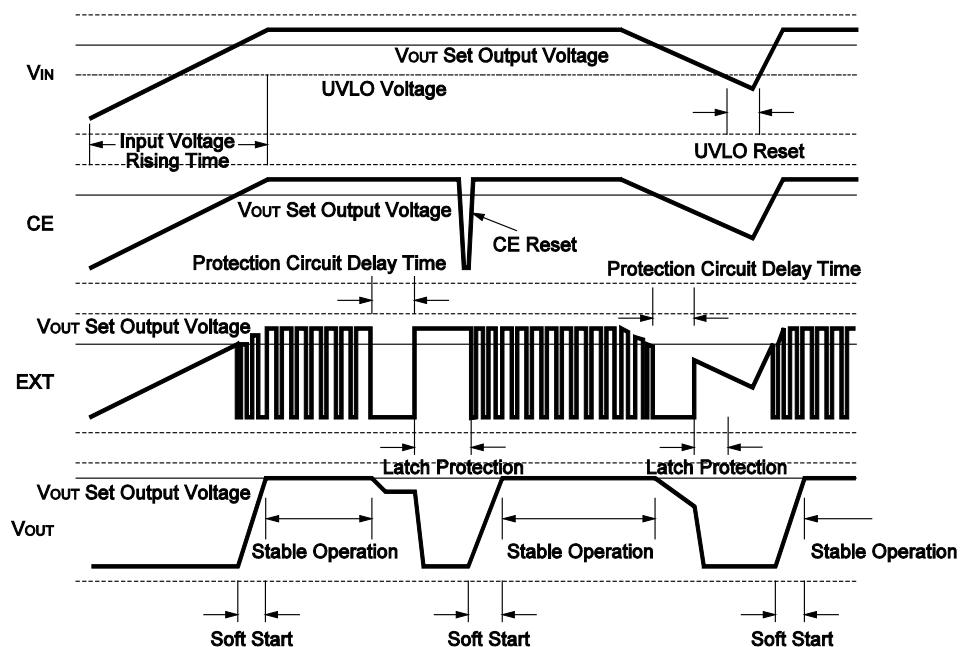

The timing chart shown above describes the changing process of input voltage rising, stable operating, operating with large current, reset with CE pin, stable operating, input voltage falling, input voltage recovering, and stable operating.

First, until when the input voltage (V_{IN}) reaches the set output voltage, the circuit inside keeps the condition of pre-standby.

Second, after V_{IN} becomes beyond the set output voltage, soft-start operation starts, when the soft-start operation finishes, the operation becomes stable.

If too large current flows through the circuit because of short or other reasons, EXT signal ignores that during the delay time of protection circuit. (The current value depends on the circuit.)

After the delay time passes, the latch protection works, or EXT signal will be "H", then output will turn off. To release the latch protection, input voltage should be equal or lower than UVLO level, or restart with CE (Once turn off the circuit with CE and turn it on again). In the timing charge above, release the latch function is realized with CE signal from "L" to "H". After removing the cause of large current and the reset with CE, soft-start operation starts and after the soft-start time, the operation will be back to stable.

If the V_{IN} becomes lower than the set V_{OUT} , that situation is same as large current condition, so protection circuit may be ready to work, therefore, after the delay time of protection circuit, EXT will be "H" and the output turns off.

Further, if the V_{IN} is lower than UVLO voltage, the circuit inside will be stopped by UVLO function. After that, if V_{IN} rises, until when the V_{IN} reaches the set output voltage, the circuit inside keeps the condition of pre-standby. Then after V_{IN} becomes beyond the set output voltage, soft-start operation starts, when the soft-start operation finishes, the operation becomes stable.

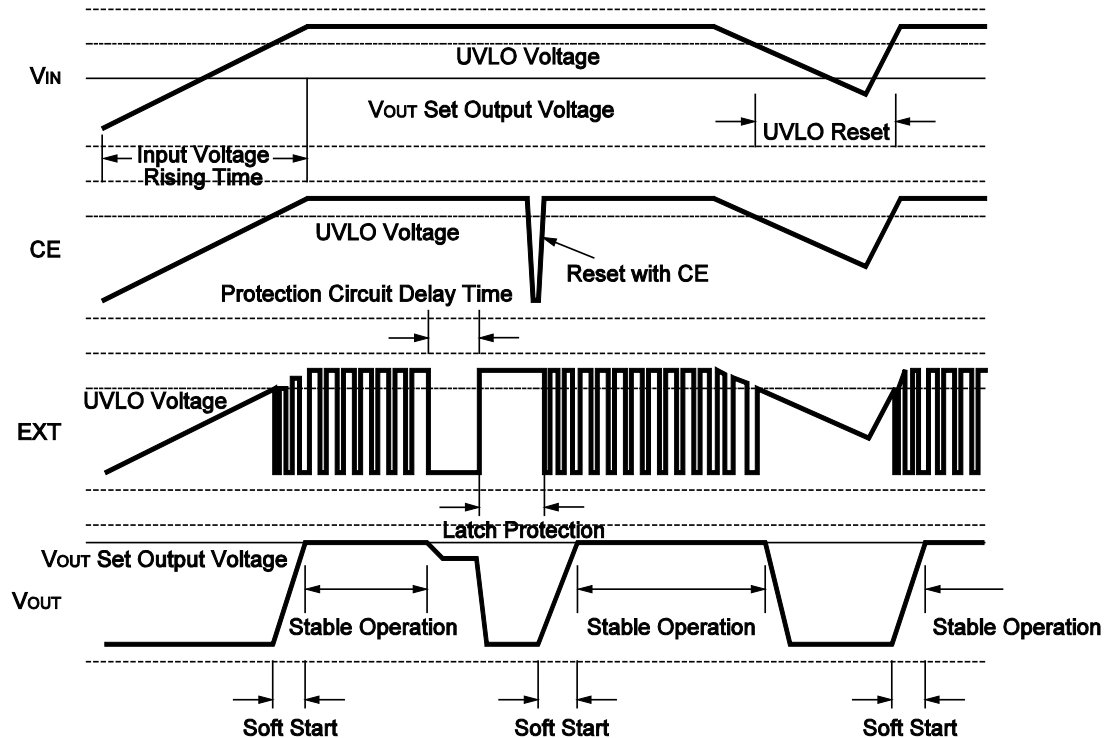
Case 2. Set V_{OUT} Voltage ≤ 2.0 V (Set V_{OUT} Voltage $<$ UVLO Voltage)

The timing chart shown above describes the changing process of input voltage rising, stable operating, operating with large current, reset with CE pin, stable operating, input voltage falling, input voltage recovering, and stable operating.

First, until when the input voltage (V_{IN}) reaches the UVLO voltage, the circuit inside keeps the condition of pre-standby. Second, after V_{IN} becomes beyond the UVLO voltage, soft-start operation starts, when the soft-start operation finishes, the operation becomes stable. If too large current flows through the circuit because of short or other reasons, EXT signal ignores that during the delay time of protection circuit. (The current value depends on the circuit.) After the delay time passes, the latch protection works, or EXT signal will be "H", then output will turn off. To release the latch protection, input voltage should be equal or lower than UVLO level, or restart with CE (Once turn off the circuit with CE and turn it on again). In the timing charge above, release the latch function is realized with CE signal from "L" to "H". After removing the cause of large current and the reset with CE, soft-start operation starts and after the soft-start time, the operation will be back to stable. Further, if the V_{IN} is lower than UVLO voltage, the circuit inside will be stopped by UVLO function. After that, if V_{IN} rises, until when the V_{IN} reaches UVLO voltage, the circuit inside keeps the condition of pre-standby. Then after V_{IN} becomes beyond the UVLO voltage, soft-start operation starts, when the soft-start operation finishes, the operation becomes stable.

TEST CIRCUITS

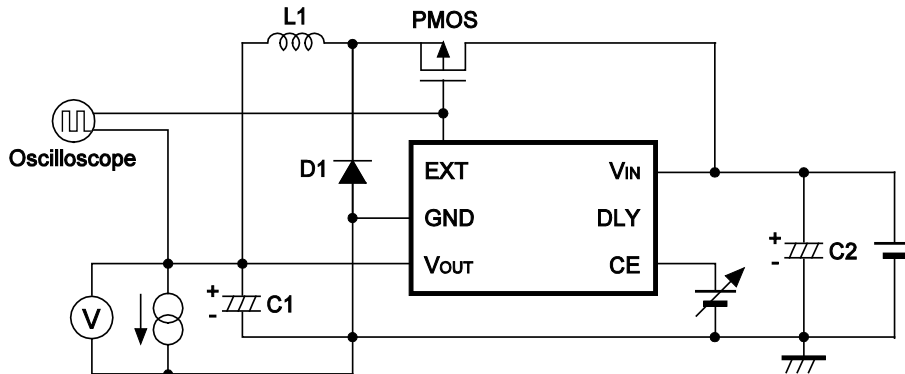

A) Output Voltage, Oscillator Frequency, CE "H" Input Voltage, CE "L" Input Voltage, Soft-start time

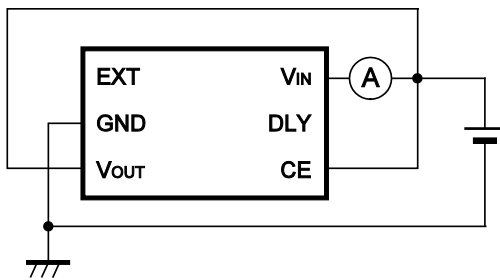

B) Supply Current 1

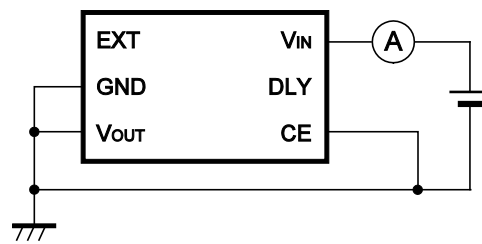

C) Standby Current

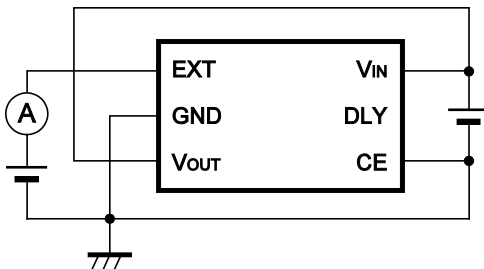

D) EXT "H" Output Current

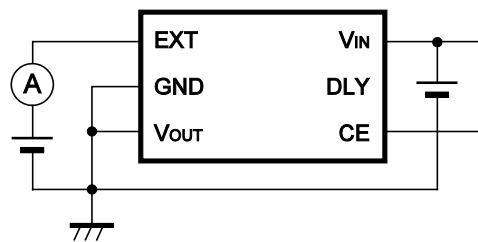

E) EXT "L" Output Current

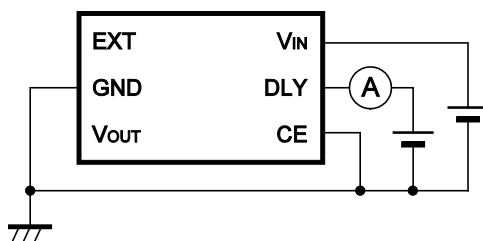

F) DLY Switching Current

R1225N

NO.EA-097-181004

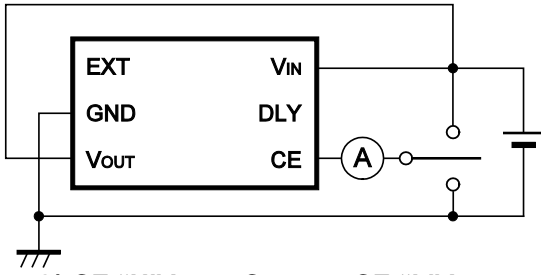
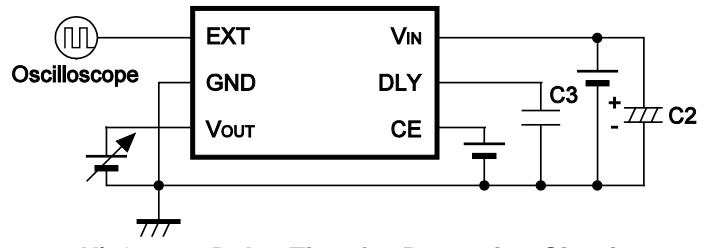
**G) CE "H" Input Current, CE "L" Input Current****H) Output Delay Time for Protection Circuit****External Components**

Symbol	Description
PMOS	Pch Power MOS, Hitachi: HAT1020R
L1	27 μ H, Sumida: CD104NP-270MC
D1	Schottky Type, ROHM: RB491D
C1	47 μ F, Tantalum Type
C2	47 μ F, Tantalum Type
C3	0.02 μ F, Ceramic Type

TYPICAL CHARACTERISTICS

1) Efficiency vs. Output Current

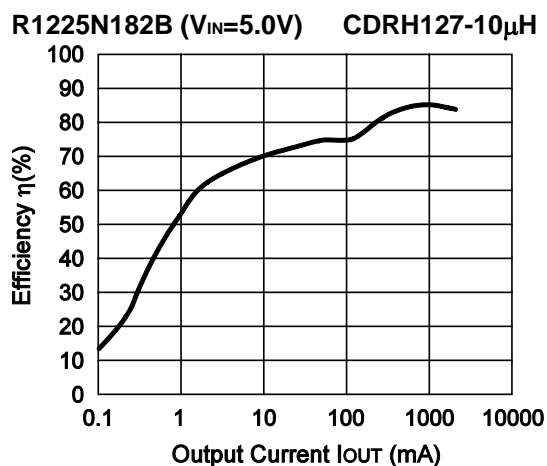
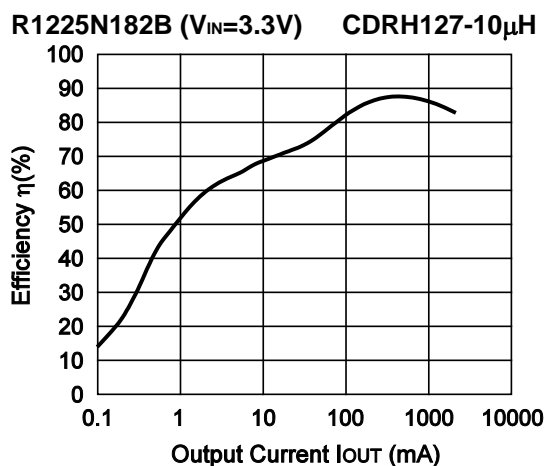

R1225N

NO.EA-097-181004

R1225N182C ($V_{IN}=3.3V$) CDRH127-10 μ H

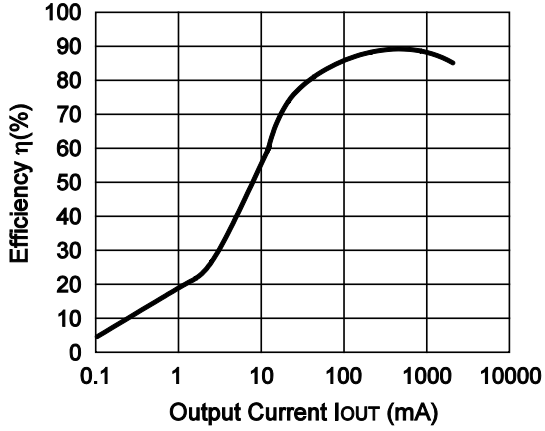

R1225N182C ($V_{IN}=5.0V$) CDRH127-10 μ H

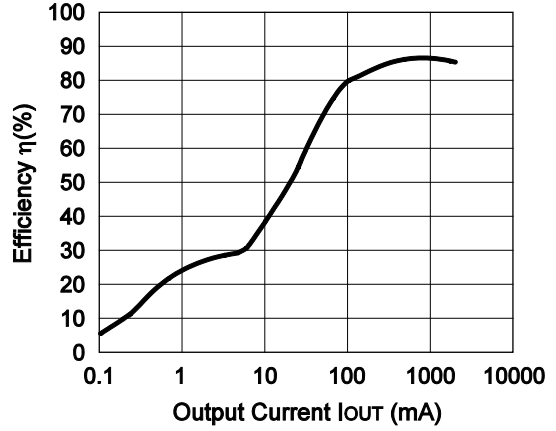

R1225N182C ($V_{IN}=12V$) CDRH127-10 μ H

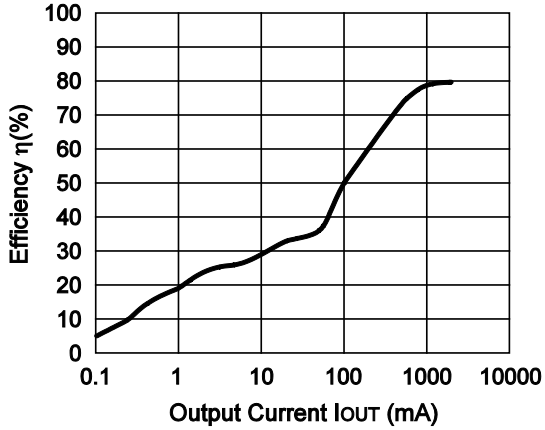

R1225N182D ($V_{IN}=3.3V$) CDRH127-10 μ H

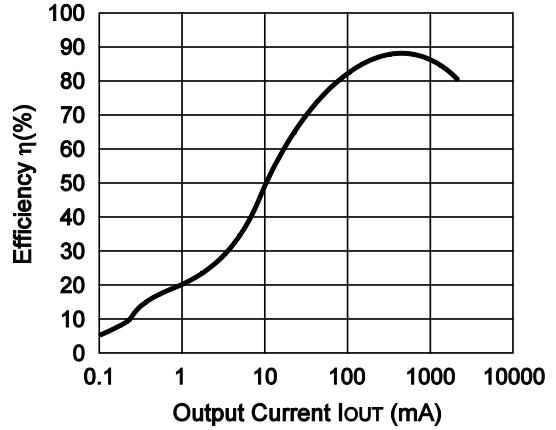

R1225N182D ($V_{IN}=5.0V$) CDRH127-10 μ H

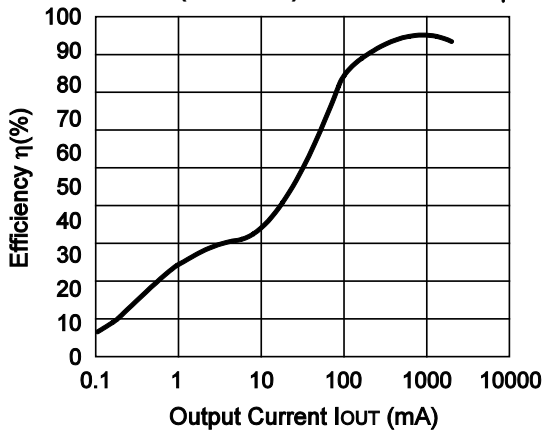

R1225N182D ($V_{IN}=12V$) CDRH127-10 μ H

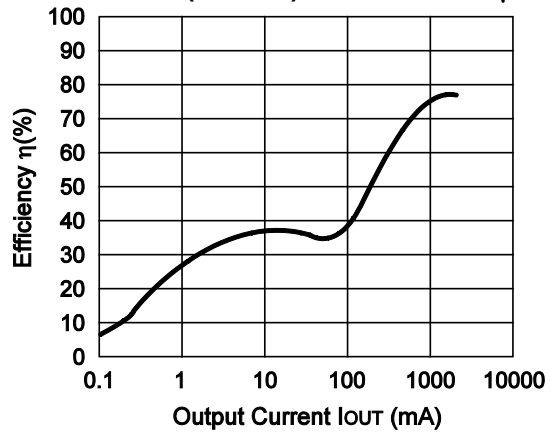

R1225N182J ($V_{IN}=3.3V$) CDRH127-27 μ H

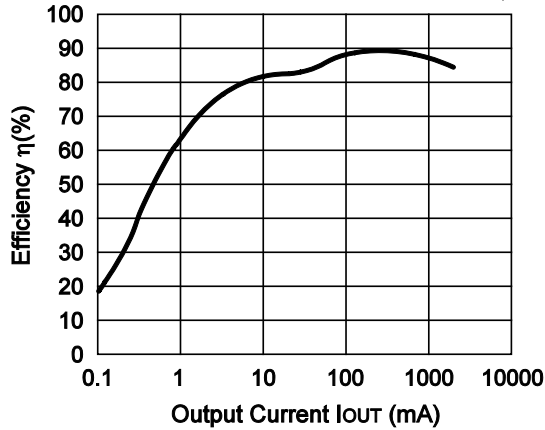

R1225N182J ($V_{IN}=5.0V$) CDRH127-27 μ H

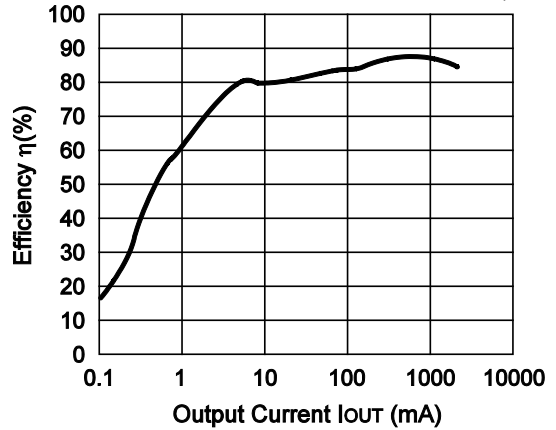

R1225N182K ($V_{IN}=3.3V$) CDRH127-27 μ H

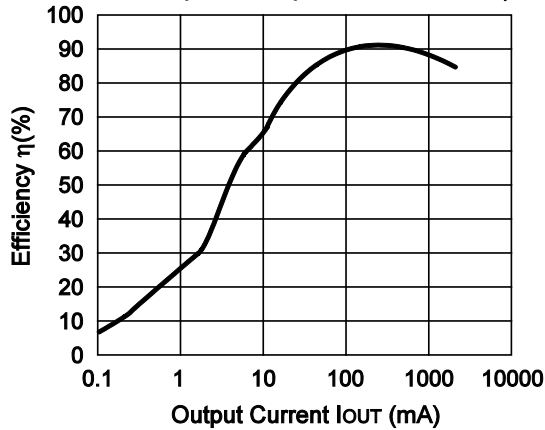

R1225N182K ($V_{IN}=5.0V$) CDRH127-27 μ H

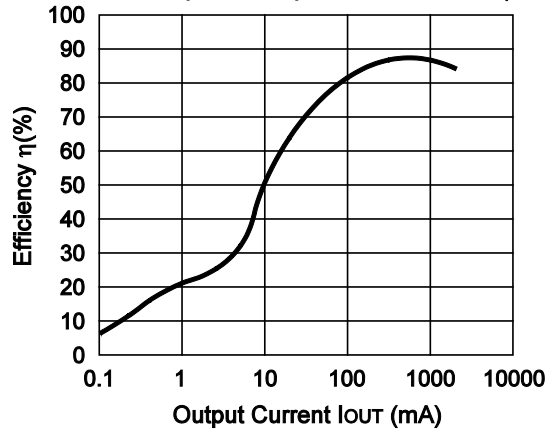

R1225N182K ($V_{IN}=12V$) CDRH127-27 μ H

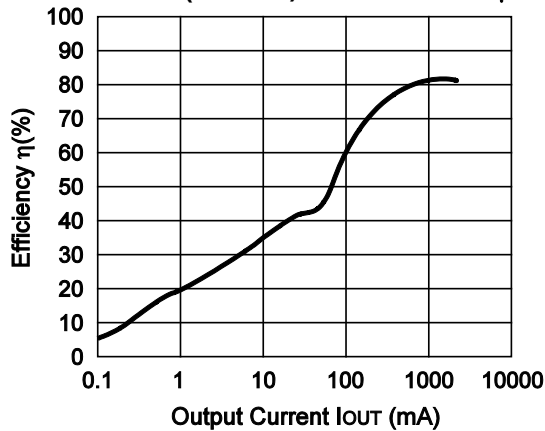

R1225N332A ($V_{IN}=4.8V$) CDRH127-10 μ H

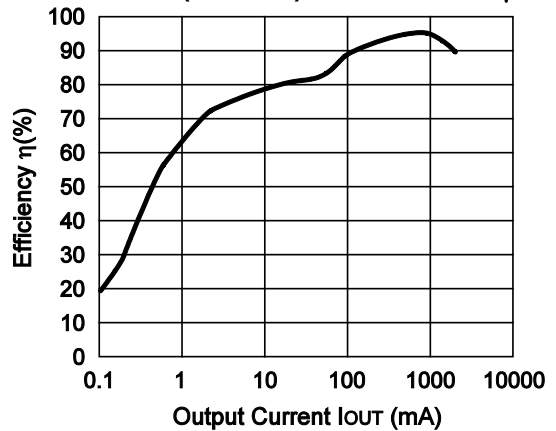

R1225N

NO.EA-097-181004

R1225N332A ($V_{IN}=7.0V$) CDRH127-10 μ H

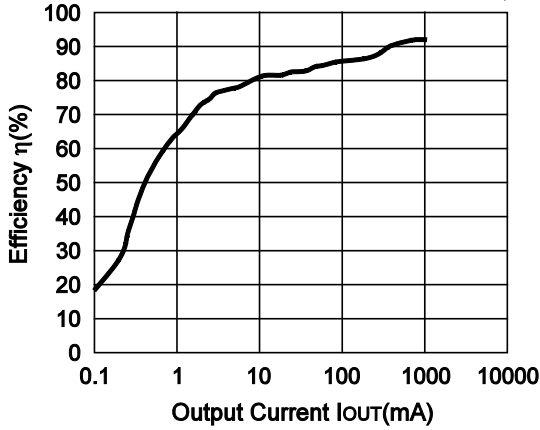

R1225N332B ($V_{IN}=4.8V$) CDRH127-10 μ H

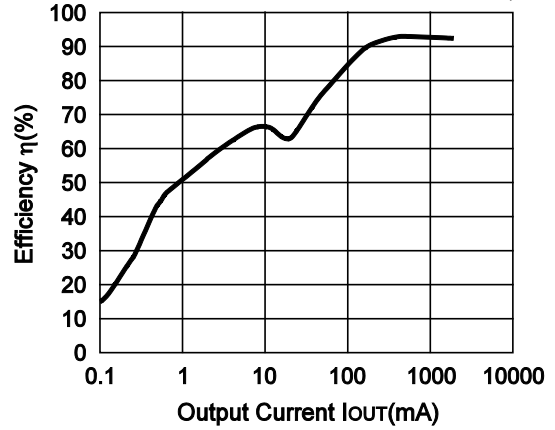

R1225N332B ($V_{IN}=7.0V$) CDRH127-10 μ H

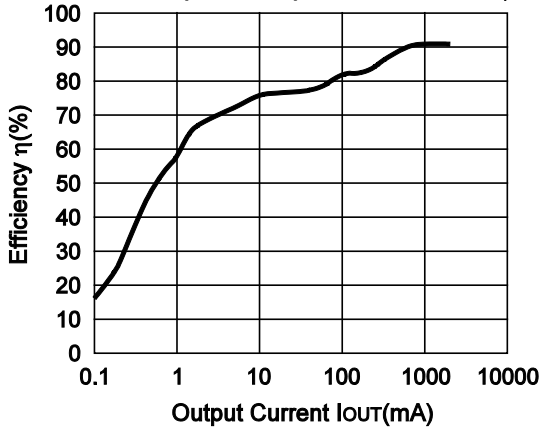

R1225N332C ($V_{IN}=4.8V$) CDRH127-10 μ H

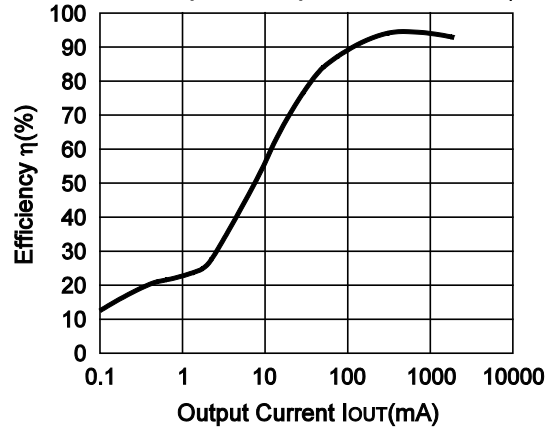

R1225N332C ($V_{IN}=12V$) CDRH127-10 μ H

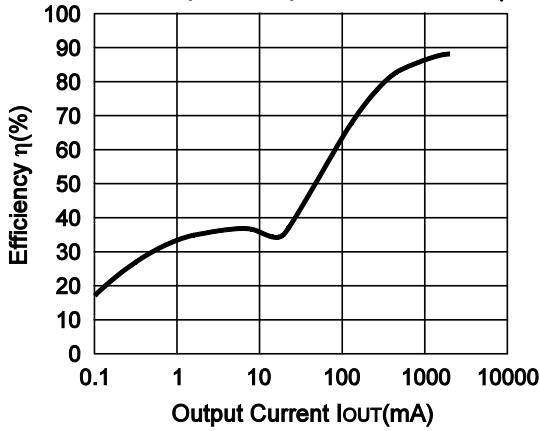

R1225N332C ($V_{IN}=15V$) CDRH127-10 μ H

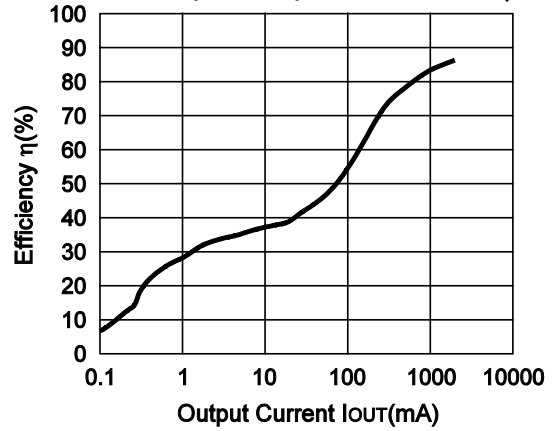

R1225N332D (V_{IN}=4.8V) CDRH127-10μH

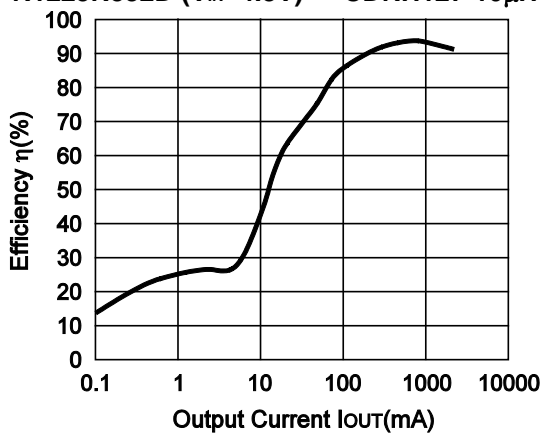

R1225N332D (V_{IN}=12V) CDRH127-10μH



R1225N332D (V_{IN}=15V) CDRH127-10μH

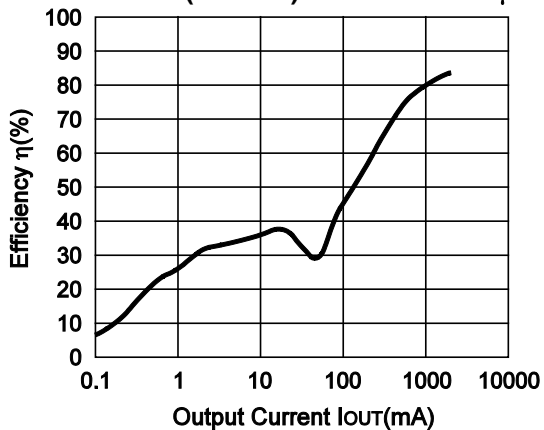

R1225N332K (V_{IN}=4.8V) CDRH127-27μH



R1225N332K (V_{IN}=12V) CDRH127-27μH

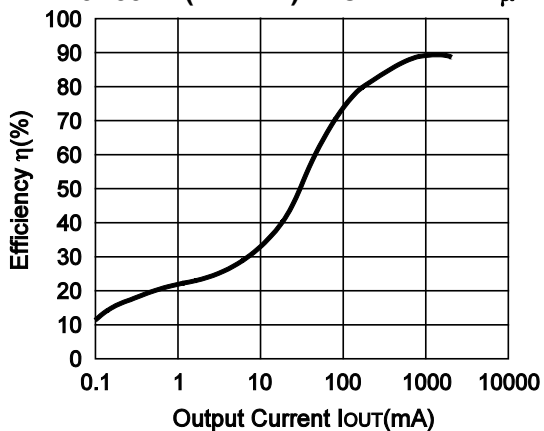

R1225N332K (V_{IN}=15V) CDRH127-27μH



R1225N

NO.EA-097-181004

R1225N502A ($V_{IN}=6.5V$) CDRH127-10 μ H

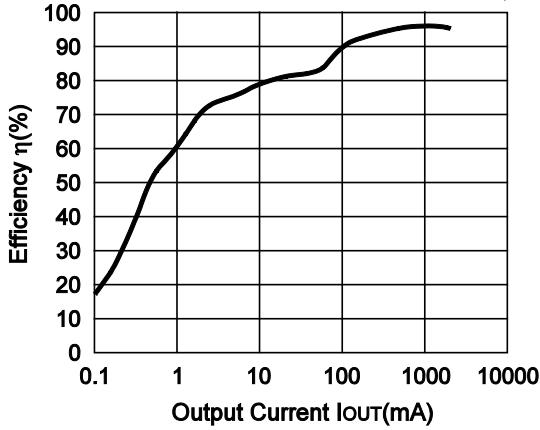

R1225N502A ($V_{IN}=10V$) CDRH127-10 μ H



R1225N502B ($V_{IN}=6.5V$) CDRH127-10 μ H

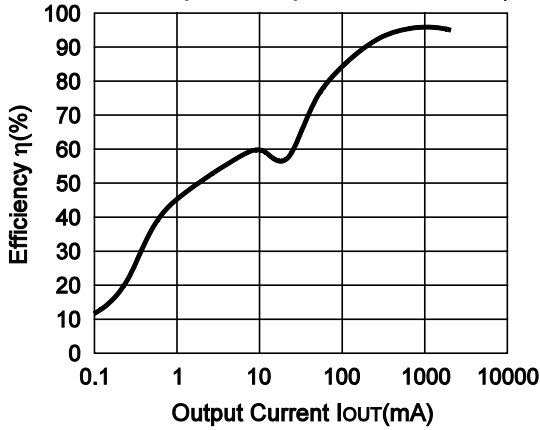

R1225N502B ($V_{IN}=10V$) CDRH127-10 μ H



R1225N502C ($V_{IN}=6.5V$) CDRH127-10 μ H

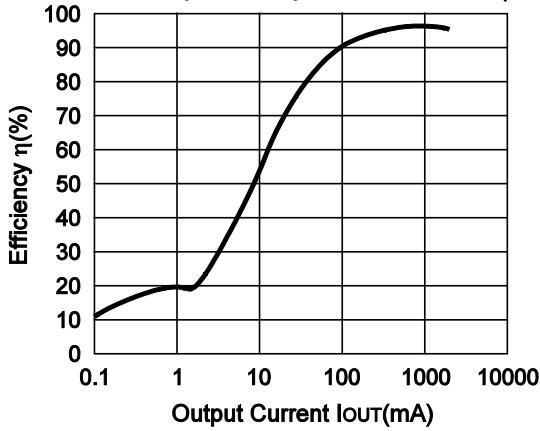

R1225N502C ($V_{IN}=12V$) CDRH127-10 μ H



R1225N502C (V_{IN}=15V) CDRH127-10μH

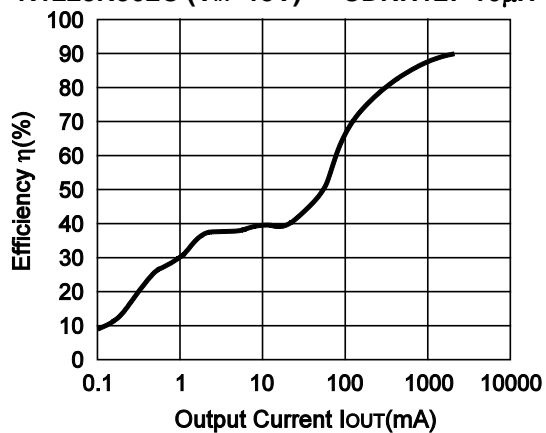

R1225N502D (V_{IN}=6.5V) CDRH127-10μH

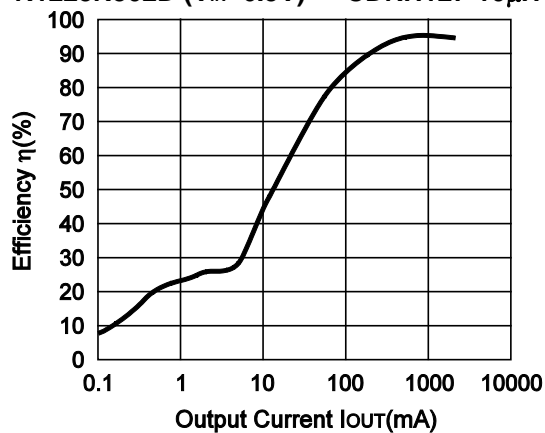

R1225N502D (V_{IN}=12V) CDRH127-10μH



R1225N502D (V_{IN}=15V) CDRH127-10μH



R1225N502J (V_{IN}=6.5V) CDRH127-27μH



R1225N502J (V_{IN}=10V) CDRH127-27μH



R1225N

NO.EA-097-181004

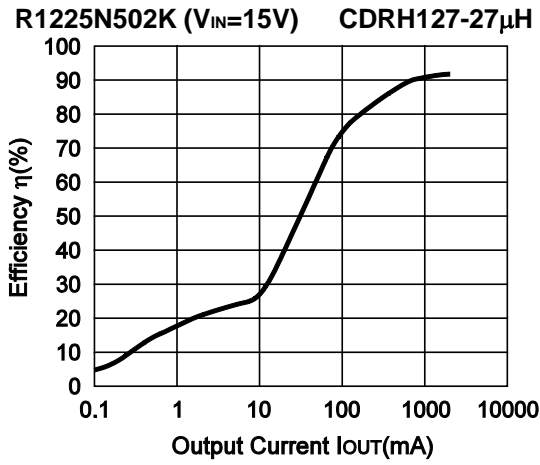
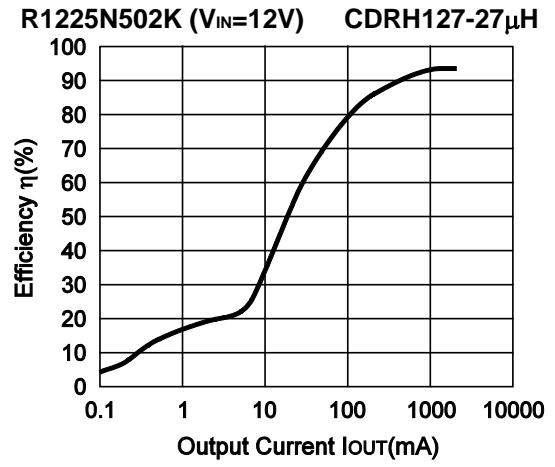
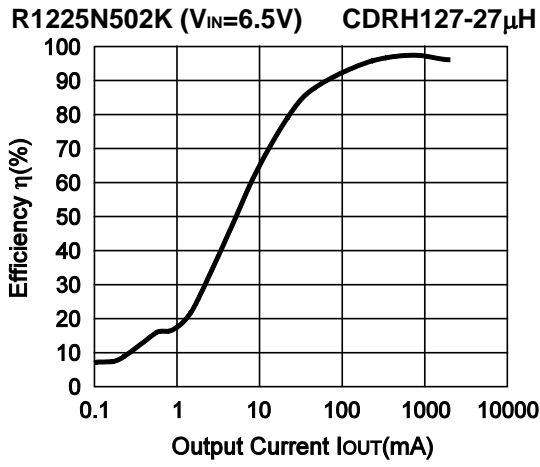

2) Ripple Voltage vs. Output Current

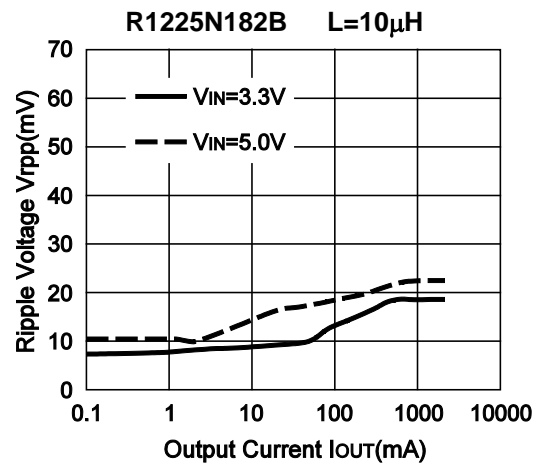
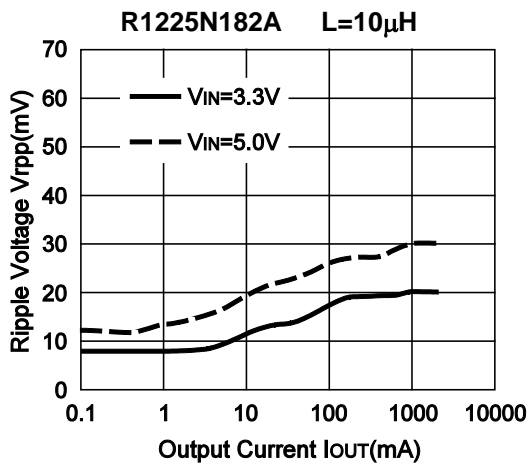



R1225N

NO.EA-097-181004



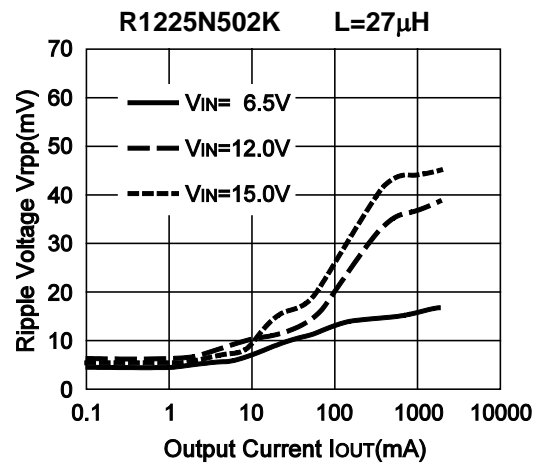
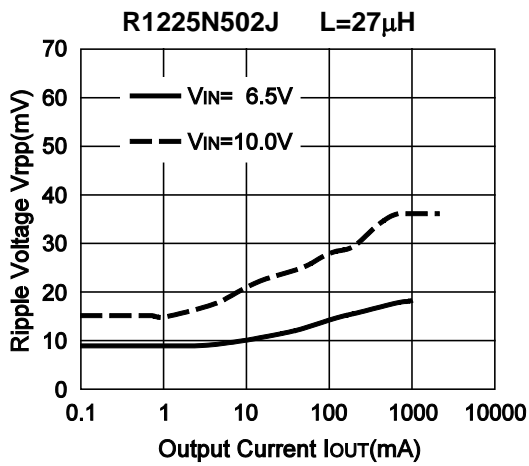
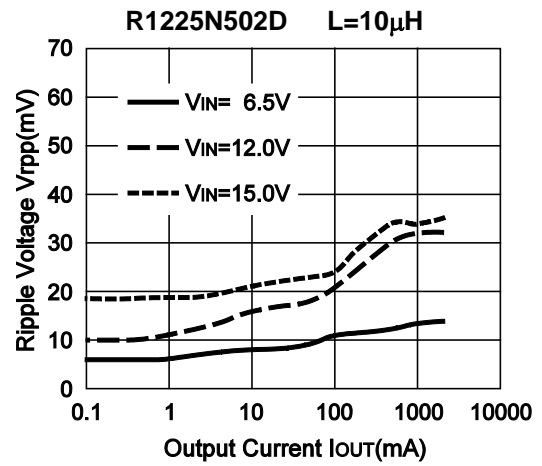
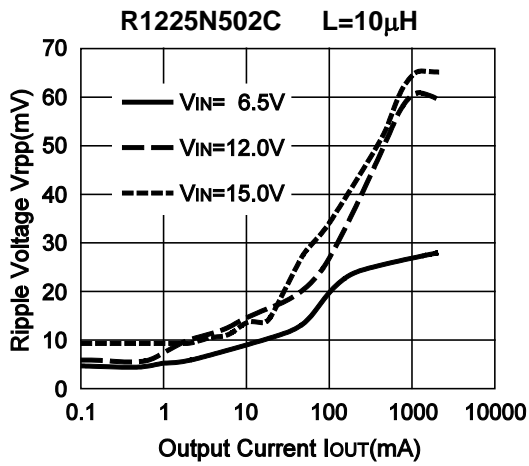

3) Input Voltage vs. Output Voltage

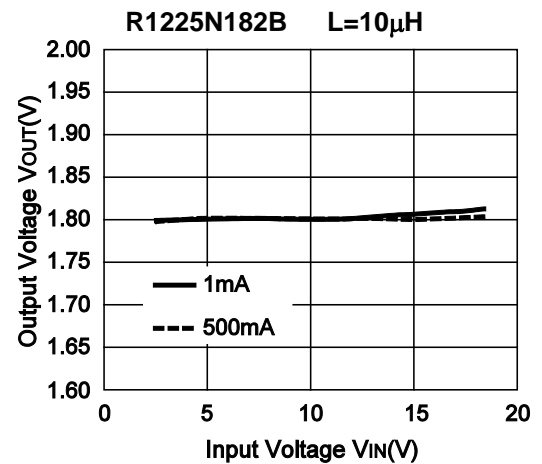
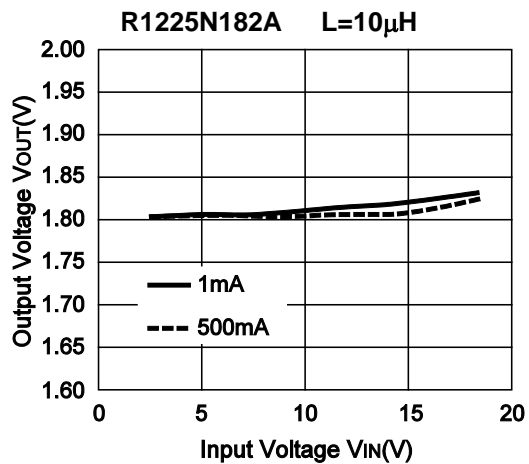

R1225N

NO.EA-097-181004





4) Output Voltage vs. Output Current

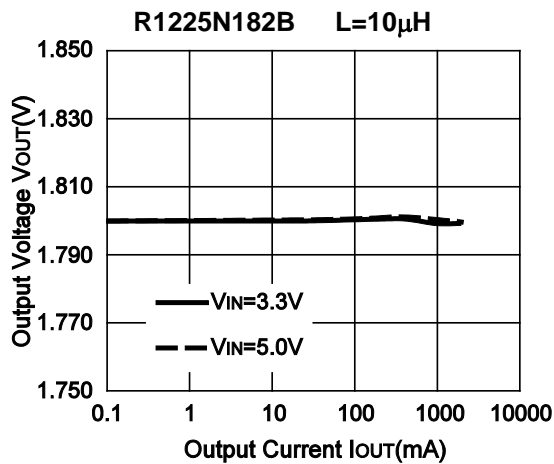
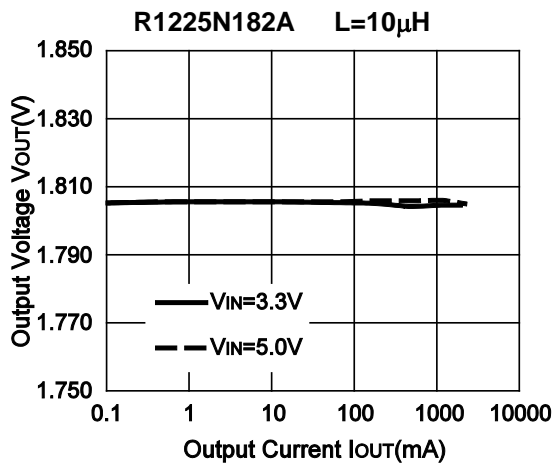

R1225N

NO.EA-097-181004



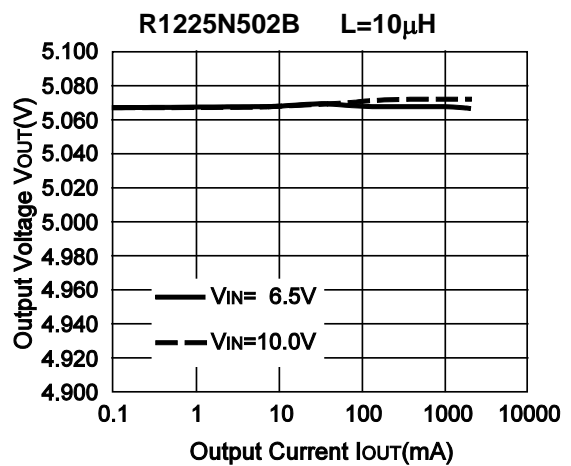
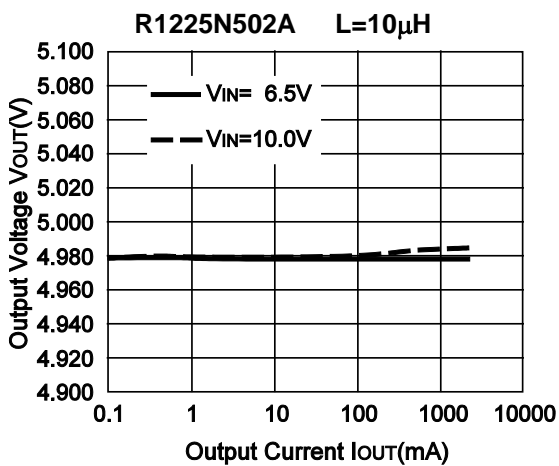
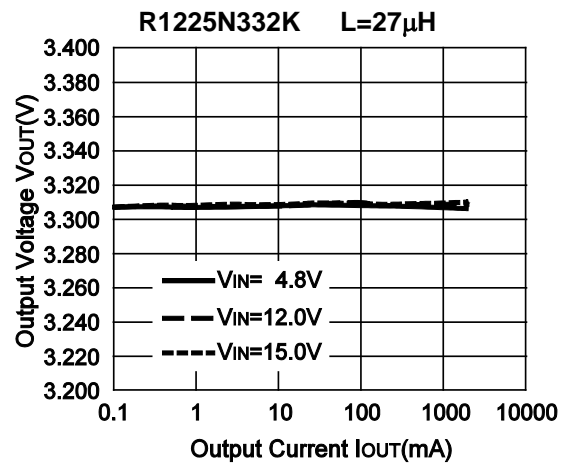
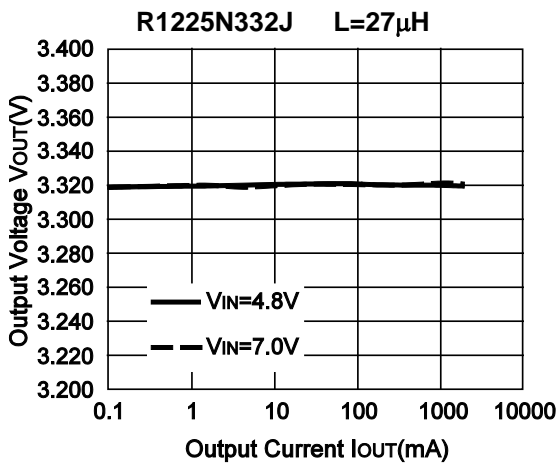
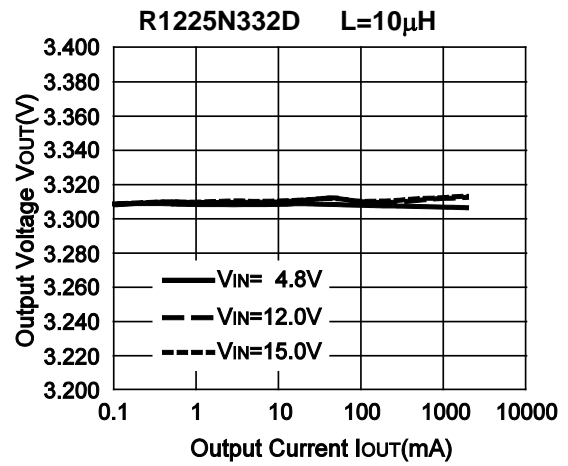
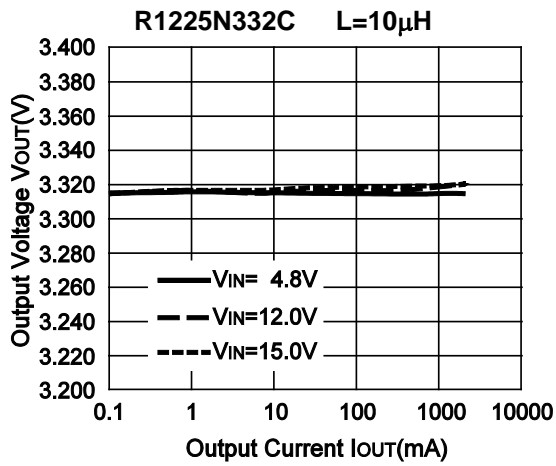

R1225N

NO.EA-097-181004

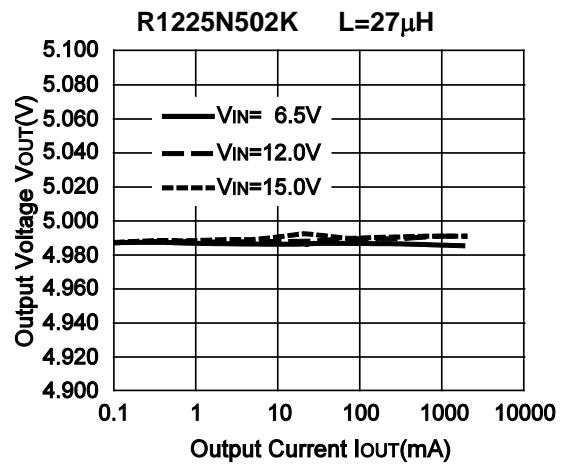
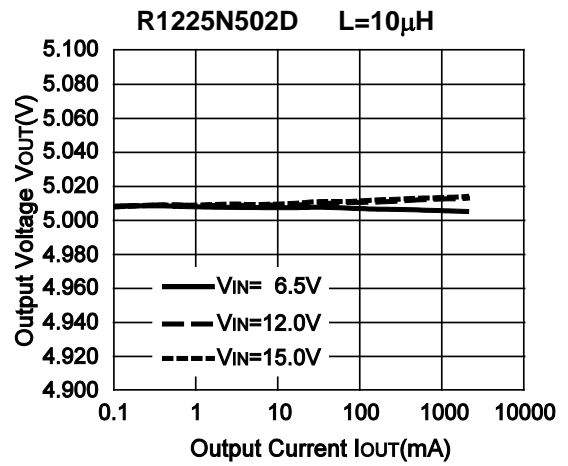

5) Load Transient Response

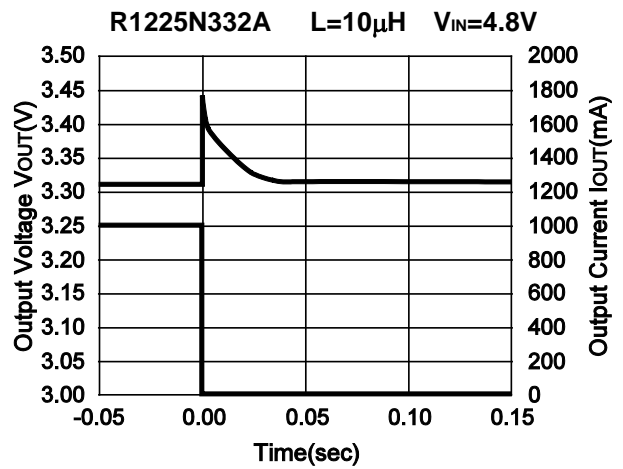
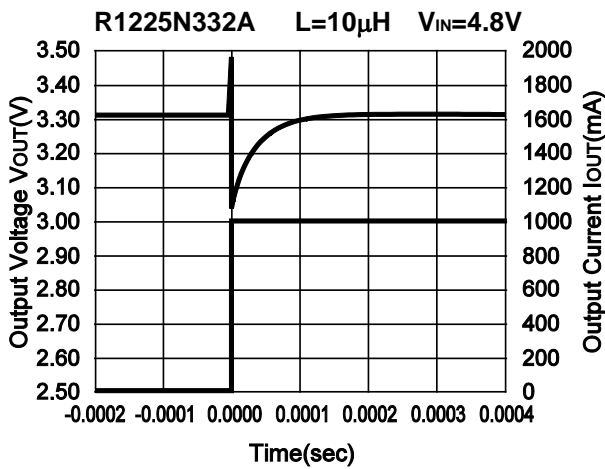

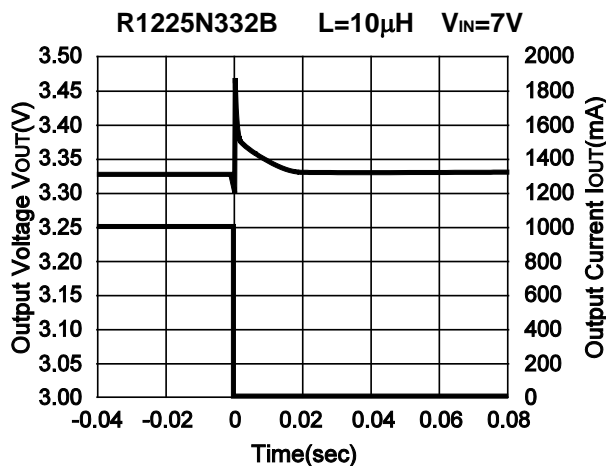
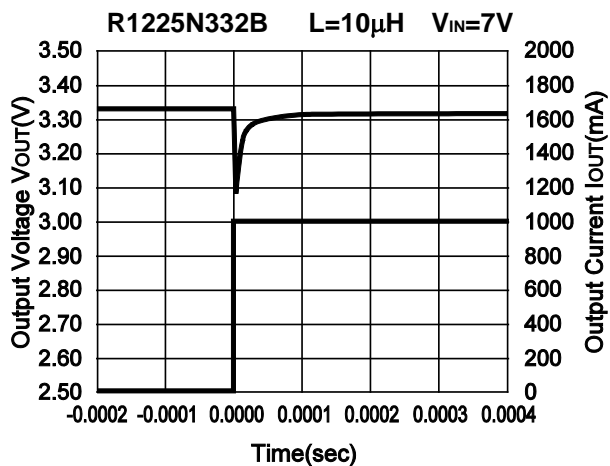
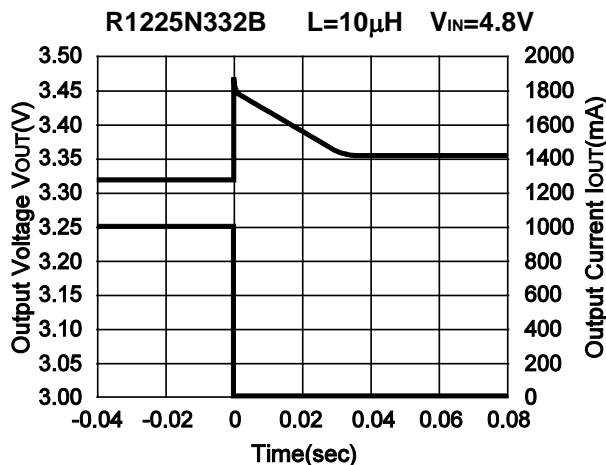
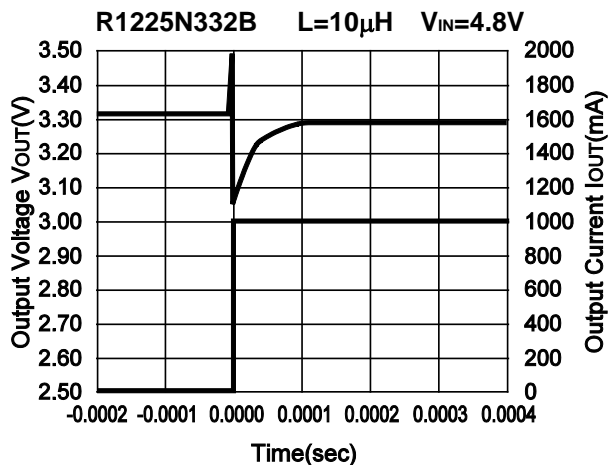
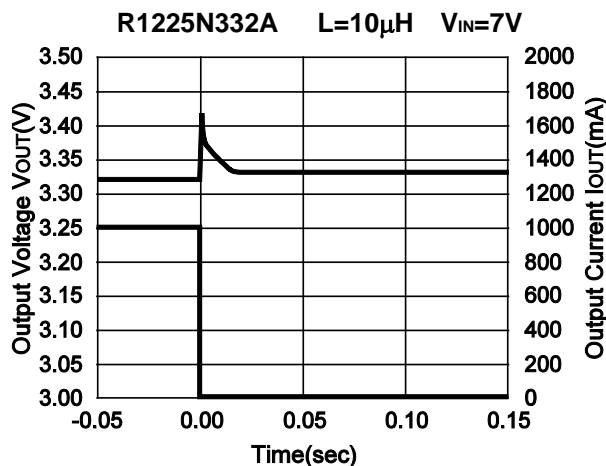
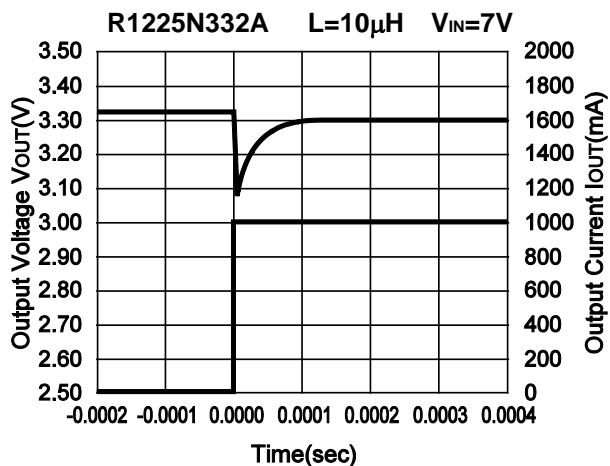

R1225N

NO.EA-097-181004

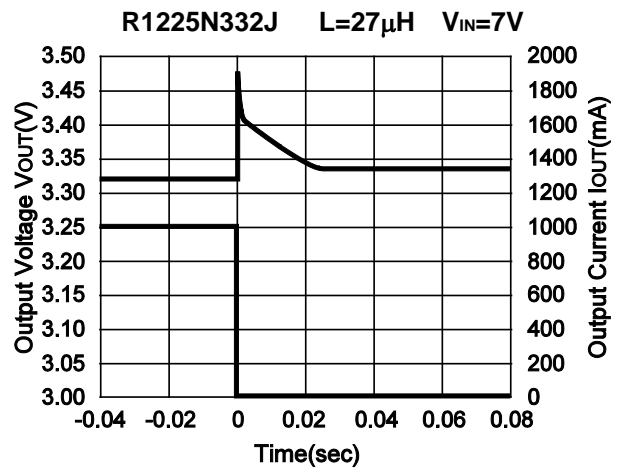
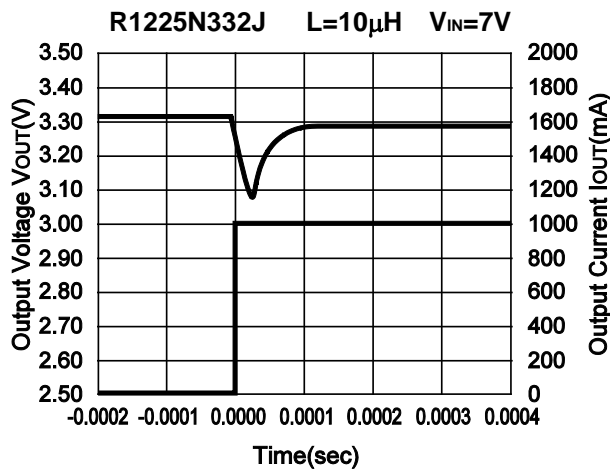
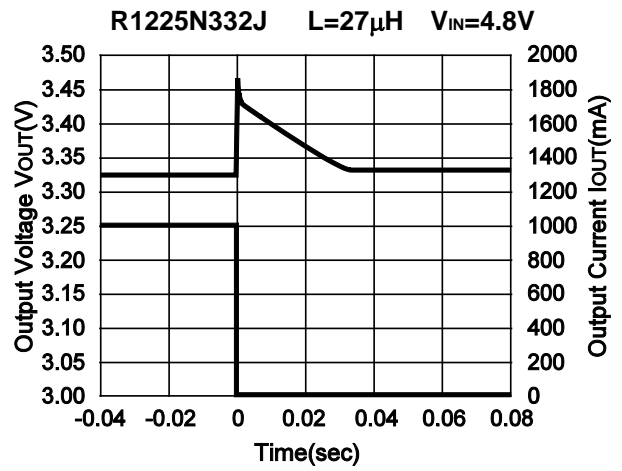
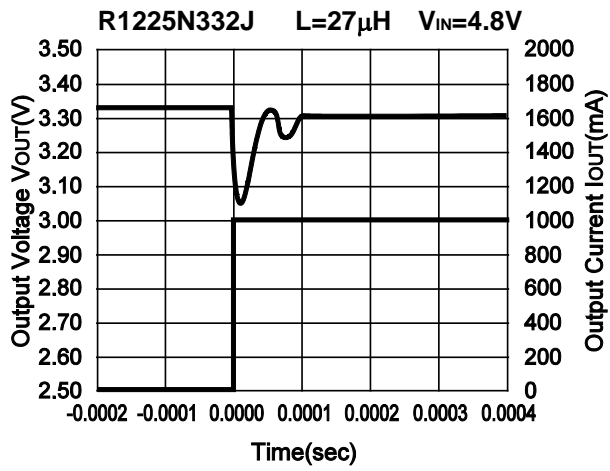



1. The products and the product specifications described in this document are subject to change or discontinuation of production without notice for reasons such as improvement. Therefore, before deciding to use the products, please refer to Ricoh sales representatives for the latest information thereon.
2. The materials in this document may not be copied or otherwise reproduced in whole or in part without prior written consent of Ricoh.
3. Please be sure to take any necessary formalities under relevant laws or regulations before exporting or otherwise taking out of your country the products or the technical information described herein.
4. The technical information described in this document shows typical characteristics of and example application circuits for the products. The release of such information is not to be construed as a warranty of or a grant of license under Ricoh's or any third party's intellectual property rights or any other rights.
5. The products listed in this document are intended and designed for use as general electronic components in standard applications (office equipment, telecommunication equipment, measuring instruments, consumer electronic products, amusement equipment etc.). Those customers intending to use a product in an application requiring extreme quality and reliability, for example, in a highly specific application where the failure or misoperation of the product could result in human injury or death (aircraft, spacevehicle, nuclear reactor control system, traffic control system, automotive and transportation equipment, combustion equipment, safety devices, life support system etc.) should first contact us.
6. We are making our continuous effort to improve the quality and reliability of our products, but semiconductor products are likely to fail with certain probability. In order to prevent any injury to persons or damages to property resulting from such failure, customers should be careful enough to incorporate safety measures in their design, such as redundancy feature, fire containment feature and fail-safe feature. We do not assume any liability or responsibility for any loss or damage arising from misuse or inappropriate use of the products.
7. Anti-radiation design is not implemented in the products described in this document.
8. The X-ray exposure can influence functions and characteristics of the products. Confirm the product functions and characteristics in the evaluation stage.
9. WLCSP products should be used in light shielded environments. The light exposure can influence functions and characteristics of the products under operation or storage.
10. There can be variation in the marking when different AOI (Automated Optical Inspection) equipment is used. In the case of recognizing the marking characteristic with AOI, please contact Ricoh sales or our distributor before attempting to use AOI.
11. Please contact Ricoh sales representatives should you have any questions or comments concerning the products or the technical information.



Ricoh is committed to reducing the environmental loading materials in electrical devices with a view to contributing to the protection of human health and the environment.

Ricoh has been providing RoHS compliant products since April 1, 2006 and Halogen-free products since April 1, 2012.

RICOH RICOH ELECTRONIC DEVICES CO., LTD.

<https://www.e-devices.ricoh.co.jp/en/>

Sales & Support Offices

Ricoh Electronic Devices Co., Ltd.

Shin-Yokohama Office (International Sales)

2-3, Shin-Yokohama 3-chome, Kohoku-ku, Yokohama-shi, Kanagawa, 222-8530, Japan
Phone: +81-50-3814-7687 Fax: +81-45-474-0074

Ricoh Americas Holdings, Inc.

675 Campbell Technology Parkway, Suite 200 Campbell, CA 95008, U.S.A.
Phone: +1-408-610-3105

Ricoh Europe (Netherlands) B.V.

Semiconductor Support Centre

Prof. W.H. Keesomlaan 1, 1183 DJ Amstelveen, The Netherlands
Phone: +31-20-5474-309

Ricoh International B.V. - German Branch

Semiconductor Sales and Support Centre

Oberrather Strasse 6, 40472 Düsseldorf, Germany
Phone: +49-211-6546-0

Ricoh Electronic Devices Korea Co., Ltd.

3F, Haesung Bldg, 504, Teheran-ro, Gangnam-gu, Seoul, 135-725, Korea
Phone: +82-2-2135-5700 Fax: +82-2-2051-5713

Ricoh Electronic Devices Shanghai Co., Ltd.

Room 403, No.2 Building, No.690 Bibo Road, Pu Dong New District, Shanghai 201203,
People's Republic of China
Phone: +86-21-5027-3200 Fax: +86-21-5027-3299

Ricoh Electronic Devices Shanghai Co., Ltd.

Shenzhen Branch

1205, Block D (Jinlong Building), Kingkey 100, Hongbao Road, Luohu District,
Shenzhen, China
Phone: +86-755-8348-7600 Ext 225

Ricoh Electronic Devices Co., Ltd.

Taipei office

Room 109, 10F-1, No.51, Hengyang Rd., Taipei City, Taiwan
Phone: +886-2-2313-1621/1622 Fax: +886-2-2313-1623

Mouser Electronics

Authorized Distributor

Click to View Pricing, Inventory, Delivery & Lifecycle Information:

Ricoh Electronics:

[R1225N122A-TR-FE](#) [R1225N122B-TR-FE](#) [R1225N122D-TR-FE](#) [R1225N122J-TR-FE](#) [R1225N122K-TR-FE](#)
[R1225N152A-TR-FE](#) [R1225N602K-TR-FE](#) [R1225N502J-TR-FE](#) [R1225N502K-TR-FE](#) [R1225N542A-TR-FE](#)
[R1225N552K-TR-FE](#) [R1225N602C-TR-FE](#) [R1225N602D-TR-FE](#) [R1225N332K-TR-FE](#) [R1225N362B-TR-FE](#)
[R1225N502A-TR-FE](#) [R1225N502B-TR-FE](#) [R1225N502C-TR-FE](#) [R1225N502D-TR-FE](#) [R1225N302K-TR-FE](#)
[R1225N332A-TR-FE](#) [R1225N332B-TR-FE](#) [R1225N332C-TR-FE](#) [R1225N332D-TR-FE](#) [R1225N332J-TR-FE](#)
[R1225N252K-TR-FE](#) [R1225N302A-TR-FE](#) [R1225N302B-TR-FE](#) [R1225N302C-TR-FE](#) [R1225N302D-TR-FE](#)
[R1225N302J-TR-FE](#) [R1225N182D-TR-FE](#) [R1225N182J-TR-FE](#) [R1225N182K-TR-FE](#) [R1225N252B-TR-FE](#)
[R1225N252C-TR-FE](#) [R1225N252D-TR-FE](#) [R1225N162D-TR-FE](#) [R1225N172B-TR-FE](#) [R1225N172D-TR-FE](#)
[R1225N182A-TR-FE](#) [R1225N182B-TR-FE](#) [R1225N182C-TR-FE](#) [R1225N152B-TR-FE](#) [R1225N152C-TR-FE](#)
[R1225N152D-TR-FE](#) [R1225N152J-TR-FE](#) [R1225N152K-TR-FE](#) [R1225N162B-TR-FE](#)

Данный компонент на территории Российской Федерации

Вы можете приобрести в компании MosChip.

Для оперативного оформления запроса Вам необходимо перейти по данной ссылке:

<http://moschip.ru/get-element>

Вы можете разместить у нас заказ для любого Вашего проекта, будь то серийное производство или разработка единичного прибора.

В нашем ассортименте представлены ведущие мировые производители активных и пассивных электронных компонентов.

Нашей специализацией является поставка электронной компонентной базы двойного назначения, продукции таких производителей как XILINX, Intel (ex.ALTERA), Vicor, Microchip, Texas Instruments, Analog Devices, Mini-Circuits, Amphenol, Glenair.

Сотрудничество с глобальными дистрибьюторами электронных компонентов, предоставляет возможность заказывать и получать с международных складов практически любой перечень компонентов в оптимальные для Вас сроки.

На всех этапах разработки и производства наши партнеры могут получить квалифицированную поддержку опытных инженеров.

Система менеджмента качества компании отвечает требованиям в соответствии с ГОСТ Р ИСО 9001, ГОСТ РВ 0015-002 и ЭС РД 009

Офис по работе с юридическими лицами:

105318, г.Москва, ул.Щербаковская д.3, офис 1107, 1118, ДЦ «Щербаковский»

Телефон: +7 495 668-12-70 (многоканальный)

Факс: +7 495 668-12-70 (доб.304)

E-mail: info@moschip.ru

Skype отдела продаж:

moschip.ru

moschip.ru_4

moschip.ru_6

moschip.ru_9