

**Toggle Switches, Tiny, Part Number Matrix**

**MATERIAL SPECIFICATIONS:**

Contacts.....Gold over nickel or silver plate  
 Case Material.....Thermoplastic 94V-0  
 Terminals/Fixed Contacts.....Tin lead plate  
 Terminal Seal.....Epoxy on single pole, optional  
 on double pole  
 Process Seal.....ES version only (see page C16 - C17)

**ENVIRONMENTAL SPECIFICATIONS**

Operating Temperature.....-22°F to +185°F (-30°C to +85°C)  
 Storage Temperature.....-67°F to +185°F (-55°C to +85°C)  
 Solder Heat Resistance.....See page M3-4  
 U.L. (File E-46765).....Silver only

**TYPICAL PERFORMANCE CHARACTERISTICS:**

Contact Rating..... Gold: 0.4 VA max. @ 20 VDC or peak AC  
 Silver (2 pos.): 3 A @ 125 VAC or 28 VDC  
 Silver (3 pos.): 2 A @ 125 VAC or 28 VDC  
 Initial Contact Resistance..... 20 Milliohms max.  
 Contact Timing..... Break before Make  
 Insulation Resistance..... 1,000 Megohms 500 VDC min.  
 Dielectric Strength..... 1,000 Volts RMS @ sea level  
 Plunger/Actuator Travel..... 26°  
 High Torque Bushing Shoulder ..... Yes  
 Life Expectancy..... See chart below  
 Note: Hardware included with switch

TT Series

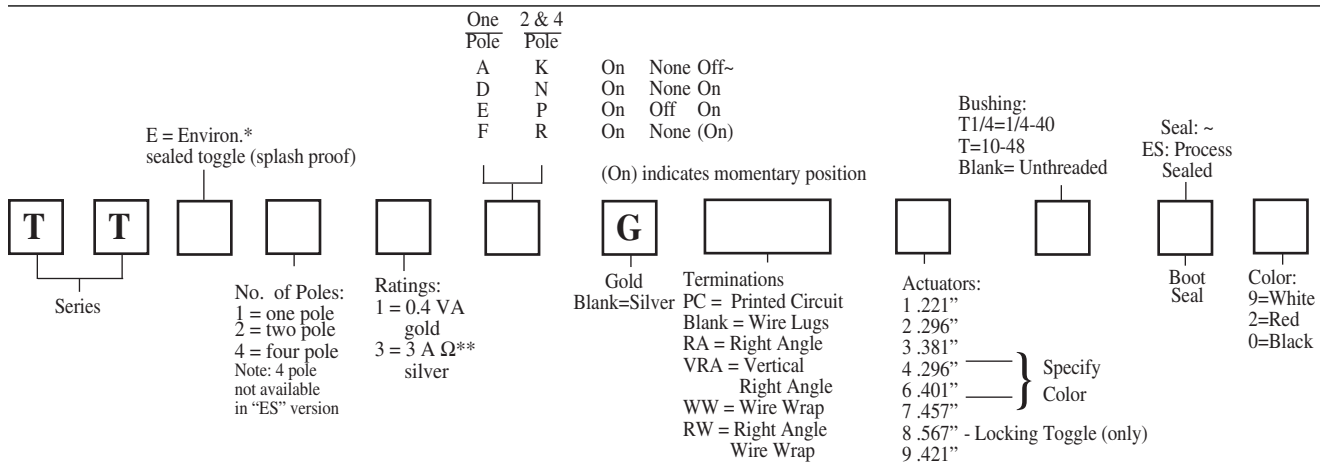

| One Pole   | 0.4VA | 80,000 (2 Pos.) | 60,000 (3 Pos.) |
|------------|-------|-----------------|-----------------|
| Two Pole   | 0.4VA | 80,000 (2 Pos.) | 60,000 (3 Pos.) |
| Three Pole | 3 Amp | 20,000 (2 Pos.) | 10,000 (3 Pos.) |
| Four Pole  | 0.4VA | 80,000 (2 Pos.) | 60,000 (3 Pos.) |
| Three Pole | 3 Amp | 20,000 (2 Pos.) | 10,000 (3 Pos.) |

**APPLICATION NOTE:**

For surface mount termination, use the "TST" series on page C5.  
 For 3 pole refer to the MT Series on page C43

|  |                              |   |
|--|------------------------------|---|
| Actuator Dimensions shown with 1,2,3,4,6 7,8,9 | 10-48 bushing 1/4-40 bushing | * Not available on 7 actuator or with VRA.<br>** Not available in RA.<br>Ω Available in PC & WL only.<br>~ Available in WL & PC only. |
|--|------------------------------|---|

**TERMINATIONS**

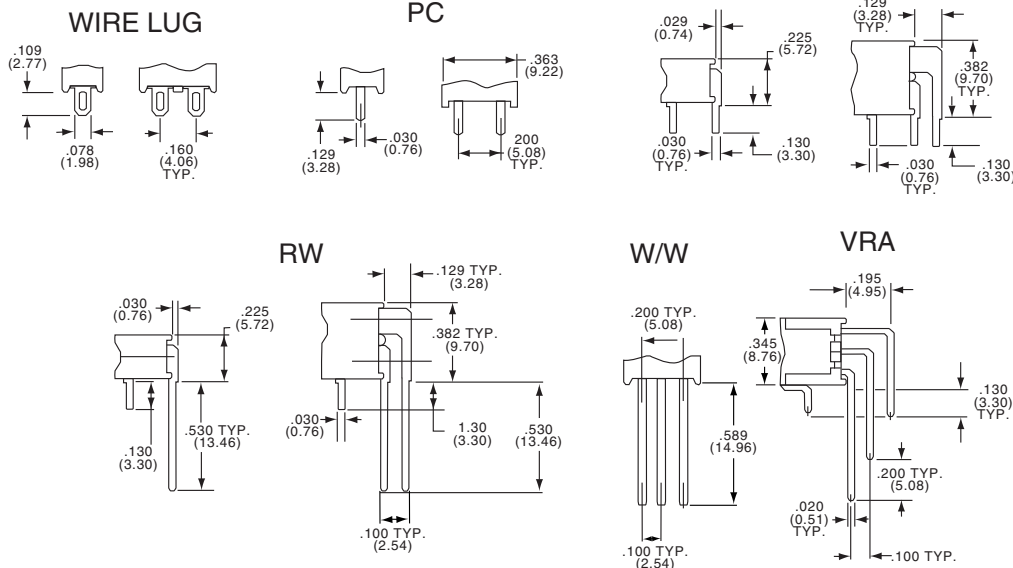

**Toggle Switches, Tiny, Actuator and Bushing Options**

Toggle Cap  
Series C-11\*  
Available



TT Series

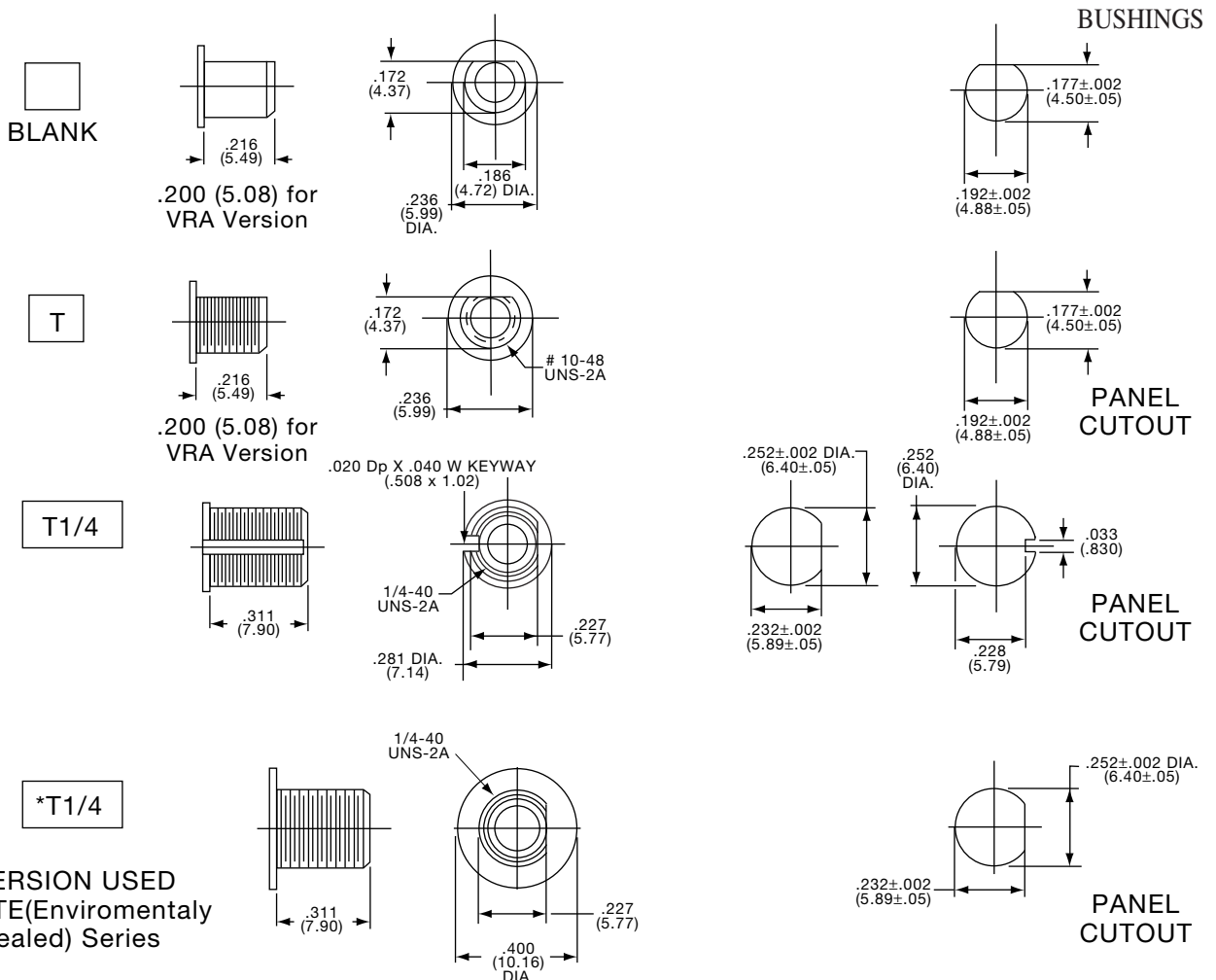

\*VERSION USED  
ON TTE(Enviromental  
Sealed) Series

**Toggle Switches, Tiny, Vertical, PC Mount**

TT Series

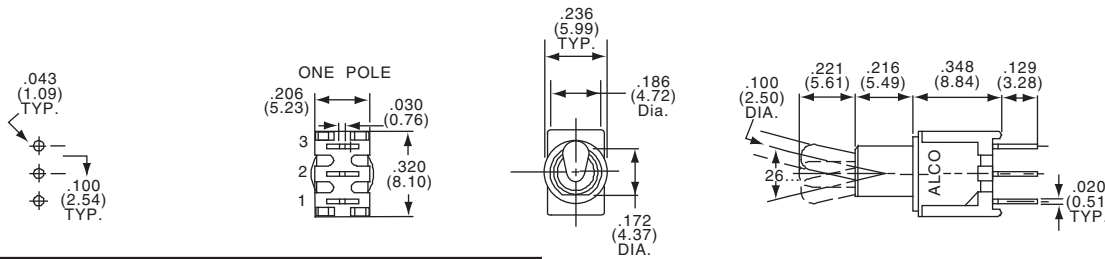

**1 POLE**  
For Terminal Connections refer to Code Chart (see page M5-6)



TT11DGPC1

| Tyco Electronics | Alcoswitch | Type | Act. Code | P. | M5   | ↖   | ↓ | ↗ |
|------------------|------------|------|-----------|----|------|-----|---|---|
| 2-1437561-3      | TT11AGPC1  | SPST | A         | On | None | Off |   |   |
| 2-1437561-6      | TT11DGPC1  | SPDT | D         | On | None | On  |   |   |
| 5-1437561-1      | TT11EGPC1  | SPDT | E         | On | Off  | On  |   |   |

Note: No center terminal on "A" switches

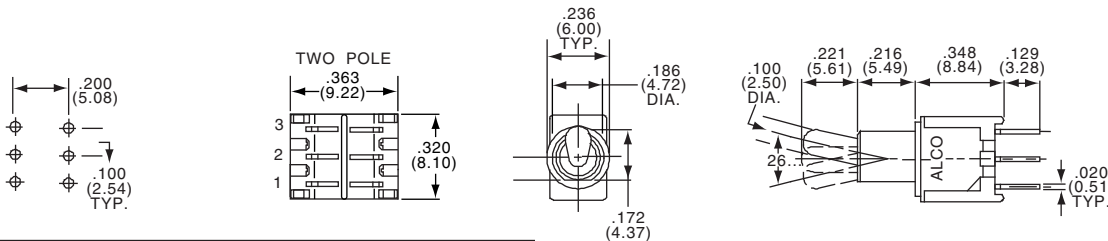

**2 POLE**  
For Terminal Connections refer to Code Chart (see page M5-6)



TT21NGPC1

| Tyco Electronics | Alcoswitch | Type | Act. Code | P. | M5   | ↖   | ↓ | ↗ |
|------------------|------------|------|-----------|----|------|-----|---|---|
| 9-1437561-9      | TT21KGPC1  | DPST | K         | On | None | Off |   |   |
| 1437562-3        | TT21NGPC1  | DPDT | N         | On | None | On  |   |   |
| 3-1437562-4      | TT21PGPC1  | DPDT | P         | On | Off  | On  |   |   |

Note: No center terminal on "K" switches

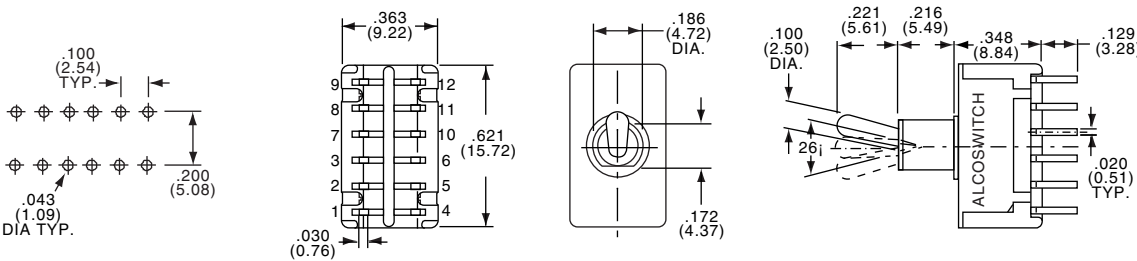

**4 POLE**

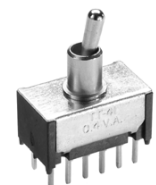

TT41NGPC1

| Tyco Electronics | Alcoswitch | Type | Act. Code | P. | M5   | ↖  | ↓ | ↗ |
|------------------|------------|------|-----------|----|------|----|---|---|
| 6-1437562-6      | TT41NGPC1  | 4PDT | N         | On | None | On |   |   |

**Toggle Switches, Tiny, Vertical and Vertical Right Angle, PC Mount**

SEE PAGE C8 FOR PRODUCT SPECIFICATIONS

For terminal connections refer to Code Chart on page M5-6

1 & 2 POLE

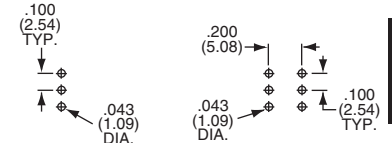
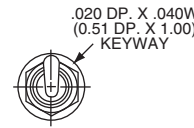
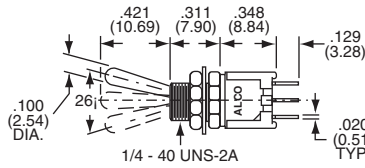

TT21NGPC9T1/4

4 POLE

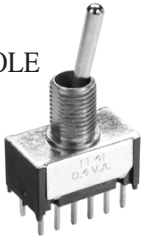

| Tyco Electronics | Alcoswitch    | Type | Act. | Code | P.   | M5  | Tyco Electronics | Alcoswitch    | Type | Act. | Code | P.   | M5   |
|------------------|---------------|------|------|------|------|-----|------------------|---------------|------|------|------|------|------|
| 2-1437561-5      | TT11AGPC9T1/4 | SPST | A    | On   | None | Off | 1-1437562-1      | TT21NGPC9T1/4 | DPDT | N    | On   | None | On   |
| 3-1437561-5      | TT11DGPC9T1/4 | SPDT | D    | On   | None | On  | 3-1437562-8      | TT21PGPC9T1/4 | DPDT | P    | On   | Off  | On   |
| 5-1437561-9      | TT11EGPC9T1/4 | SPDT | E    | On   | Off  | On  | 4-1437562-6      | TT21RGPC9T1/4 | DPDT | R    | On   | None | (On) |
| 7-1437561-3      | TT11FGPC9T1/4 | SPDT | F    | On   | None | On  | 6-1437562-8      | TT41NGPC9T1/4 | 4PDT | N    | On   | None | On   |
| 1437562-1        | TT21KGPC9T1/4 | DPST | K    | On   | None | Off | 7-1437562-5      | TT41PGPC9T1/4 | 4PDT | P    | On   | Off  | On   |

Note: No center terminal on "A" or "K" switches.

(On) indicates momentary position.

TT41NGPC9T1/4

Note: Hardware Included

1 & 2 POLE



TT1DGVRA1  
Vertical Actuation

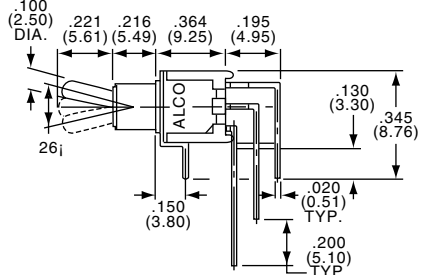
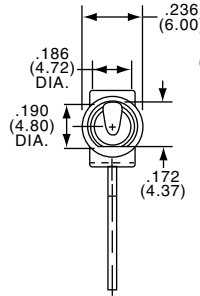
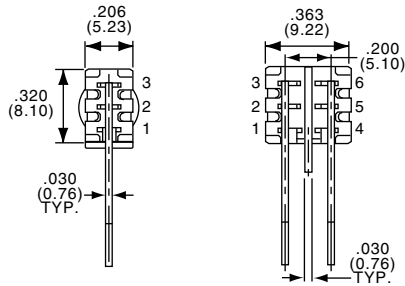

TT21NGVRA1  
Vertical Actuation

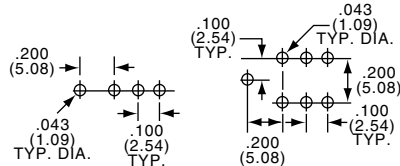

| Tyco Electronics | Alcoswitch | Type | Act. | Code | P.   | M5 |
|------------------|------------|------|------|------|------|----|
| 4-1437561-8      | TT11DGVRA1 | SPDT | D    | On   | None | On |
| 6-1437561-9      | TT11EGVRA1 | SPDT | E    | On   | Off  | On |
| 2-1437562-2      | TT21NGVRA1 | DPDT | N    | On   | None | On |
| 4-1437562-3      | TT21PGVRA1 | DPDT | P    | On   | Off  | On |

1 & 2 POLE

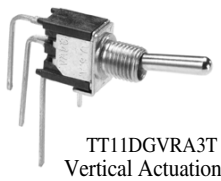

TT1DGVRA3T  
Vertical Actuation

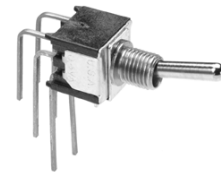
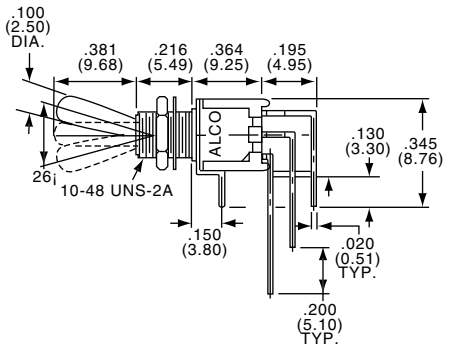
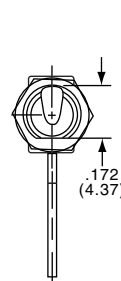
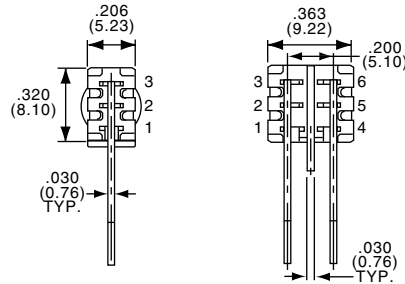

TT21NGVRA3T  
Vertical Actuation

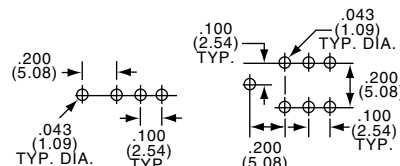

| Tyco Electronics | Alcoswitch  | Type | Act. | Code | P.   | M5 |
|------------------|-------------|------|------|------|------|----|
| 4-1437561-9      | TT11DGVRA3T | SPDT | D    | On   | None | On |
| 7-1437561-0      | TT11EGVRA3T | SPDT | E    | On   | Off  | On |
| 2-1437562-3      | TT21NGVRA3T | DPDT | N    | On   | None | On |

**Toggle Switches, Tiny, Right Angle, Flat Actuator**

SEE PAGE C8 FOR PRODUCT SPECIFICATIONS

\* Refer to Page C8 for Other Options \*

1 & 2 POLE FLAT

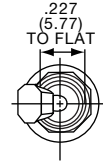
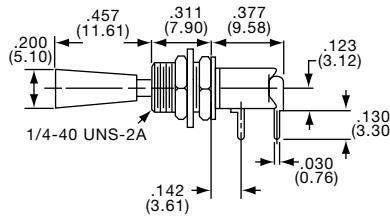
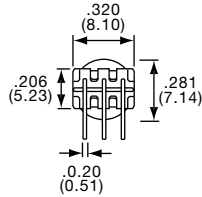
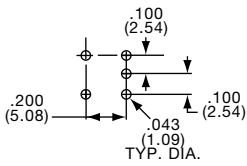

TT11DGRA7T1/4  
Horizontal Actuation

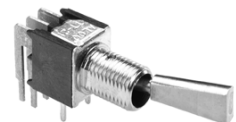
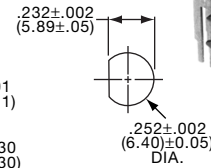
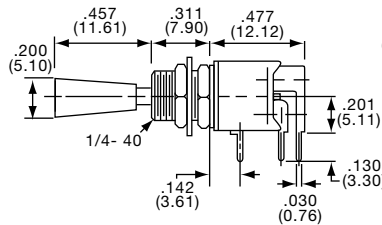
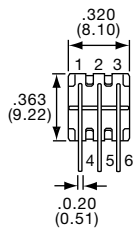
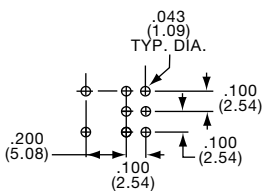

TT21NGRA7T1/4  
Horizontal Actuation

| Tyco Electronics | Alcoswitch    | Type | Act. Code | P. M5 | On | None | On   |
|------------------|---------------|------|-----------|-------|----|------|------|
| 4-1437561-5      | TT11DGRA7T1/4 | SPDT | D         |       | On | None | On   |
| 6-1437561-7      | TT11EGRA7T1/4 | SPDT | E         |       | On | Off  | On   |
| 7-1437561-4      | TT11FGRA7T1/4 | SPDT | F         |       | On | None | (On) |
| 1-1437562-9      | TT21NGRA7T1/4 | DPDT | N         |       | On | None | On   |
| 4-1437562-0      | TT21PGRA7T1/4 | DPDT | P         |       | On | Off  | On   |

(On) indicates momentary position

Pinned for Anti-Rotation

4 POLE FLAT

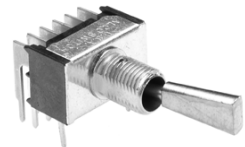
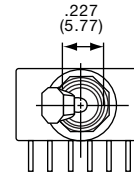
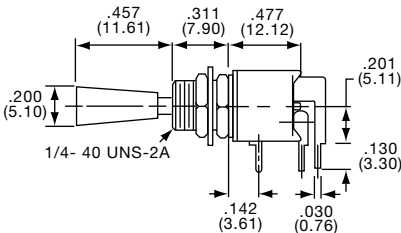
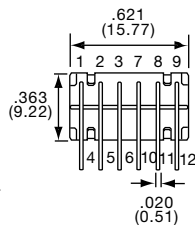
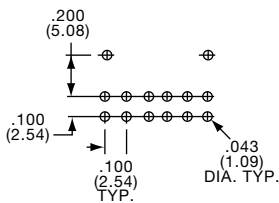

TT41NGRA7T14  
Horizontal Actuation

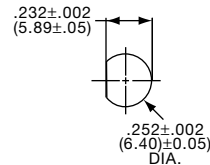

| Tyco Electronics | Alcoswitch    | Type | Act. Code | P. M5 | On | None | On |
|------------------|---------------|------|-----------|-------|----|------|----|
| 7-1437562-2      | TT41NGRA7T1/4 | 4PDT | N         |       | On | None | On |

Pinned for Anti-Rotation

**Toggle Switches, Tiny, Wire Wrap Termination**

SEE PAGE C8 FOR PRODUCT SPECIFICATIONS

For terminal connections refer to Code Chart on page M5-6

1 POLE



TT11DGWW2T

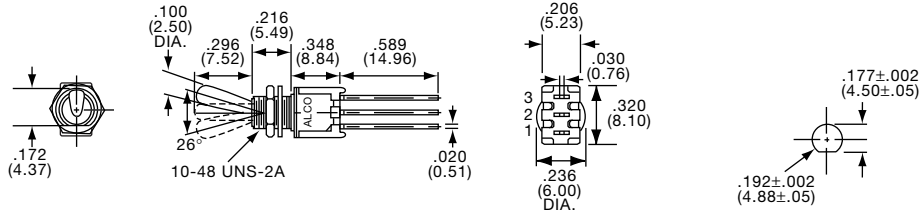

| Tyco Electronics | Alcoswitch | Type | Act. Code P. M5 |    |         |
|------------------|------------|------|-----------------|----|---------|
| 5-1437561-0      | TT11DGWW2T | SPDT | D               | On | None On |
| 7-1437561-1      | TT11EGWW2T | SPDT | E               | On | Off On  |

2 POLE



TT21NGWW2T

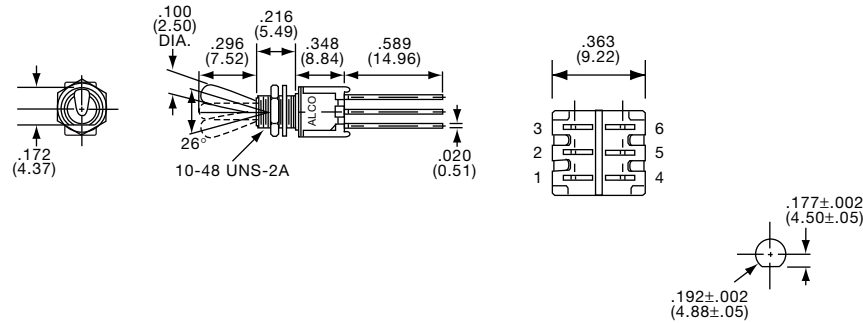

| Tyco Electronics | Alcoswitch | Type | Act. Code P. M5 |    |         |
|------------------|------------|------|-----------------|----|---------|
| 2-1437562-4      | TT21NGWW2T | DPDT | N               | On | None On |
| 4-1437562-4      | TT21PGWW2T | DPDT | P               | On | Off On  |

4 POLE

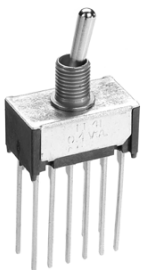

TT41NGWW2T



| Tyco Electronics | Alcoswitch | Type | Act. Code P. M5 |    |         |
|------------------|------------|------|-----------------|----|---------|
| 7-1437562-4      | TT41NGWW2T | 4PDT | N               | On | None On |



**Toggle Switches, Tiny, Wire Lug, Round or Flat Actuators**

SEE PAGE C8 FOR PRODUCT SPECIFICATIONS

For terminal connections refer to Code Chart on page M5-6

NOTICE: Wire lug terminals accept two No. 20 AWG wires.



1 & 2 POLE



TT13D2T



TT23N2T

4 POLE

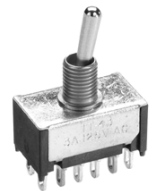

TT43N2T

| Tyco Electronics | Alcoswitch | Type | Act. Code P. M5 | On | None | Off | Tyco Electronics | Alcoswitch | Type | Act. Code P. M5 | On | None | Off |
|------------------|------------|------|-----------------|----|------|-----|------------------|------------|------|-----------------|----|------|-----|
| 7-1437561-8      | TT13A2T    | SPST | A               | On | None | Off | 5-1437562-1      | TT23N2T    | DPDT | N               | On | None | On  |
| 8-1437561-5      | TT13D2T    | SPDT | D               | On | None | On  | 5-1437562-7      | TT23P2T    | DPDT | P               | On | Off  | On  |
| 9-1437561-5      | TT13E2T    | SPDT | E               | On | Off  | On  | 7-1437562-6      | TT43N2T    | 4PDT | N               | On | None | On  |
| 4-1437562-7      | TT23K2T    | DPST | K               | On | None | Off |                  |            |      |                 |    |      |     |

Note: No center terminal "A" or "K" action switches.

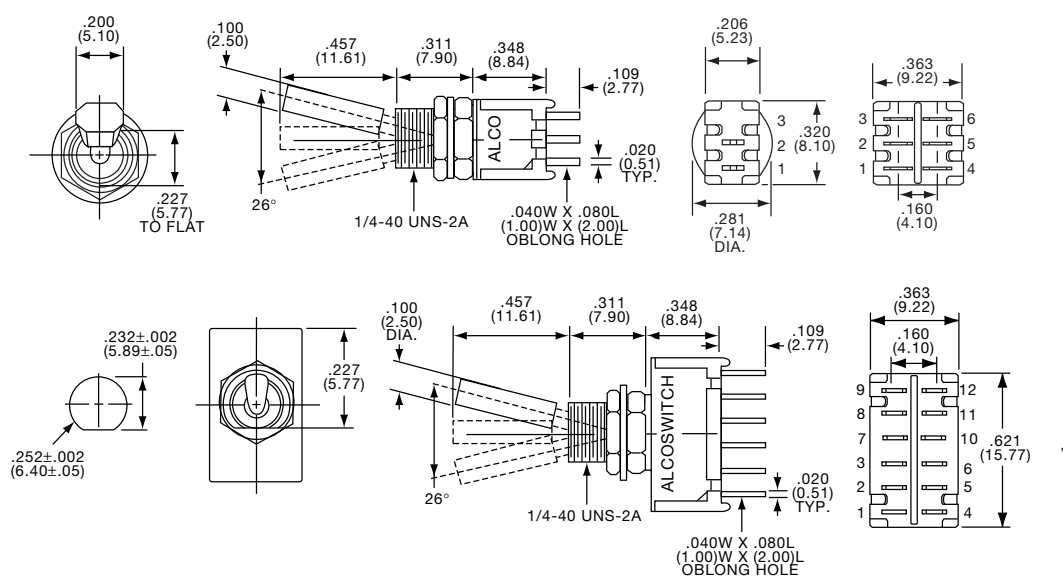

1 & 2 POLE



TT13D7T1/4



TT23N7T1/4

4 POLE



TT43N7T1/4

Pinned for Anti-Rotation

| Tyco Electronics | Alcoswitch | Type | Act. Code P. M5 | On | None | Off | Tyco Electronics | Alcoswitch | Type | Act. Code P. M5 | On | None | Off |
|------------------|------------|------|-----------------|----|------|-----|------------------|------------|------|-----------------|----|------|-----|
| 9-1437561-1      | TT13D7T1/4 | SPDT | D               | On | None | On  | 6-1437562-0      | TT23P7T1/4 | DPDT | P               | On | Off  | On  |
| 9-1437561-7      | TT13E7T1/4 | SPDT | E               | On | Off  | On  | 7-1437562-8      | TT43N7T1/4 | 4PDT | N               | On | None | On  |
| 5-1437562-5      | TT23N7T1/4 | DPST | N               | On | None | On  |                  | TT43P7T1/4 | 4PDT | P               | On | Off  | On  |

**Toggle Switches, Tiny, Wire Lug, Long Actuators**

SEE PAGE C8 FOR PRODUCT SPECIFICATIONS

For terminal connections refer to Code Chart on page M5-6

1 & 2 POLE



TT13D3T



TT23N3T

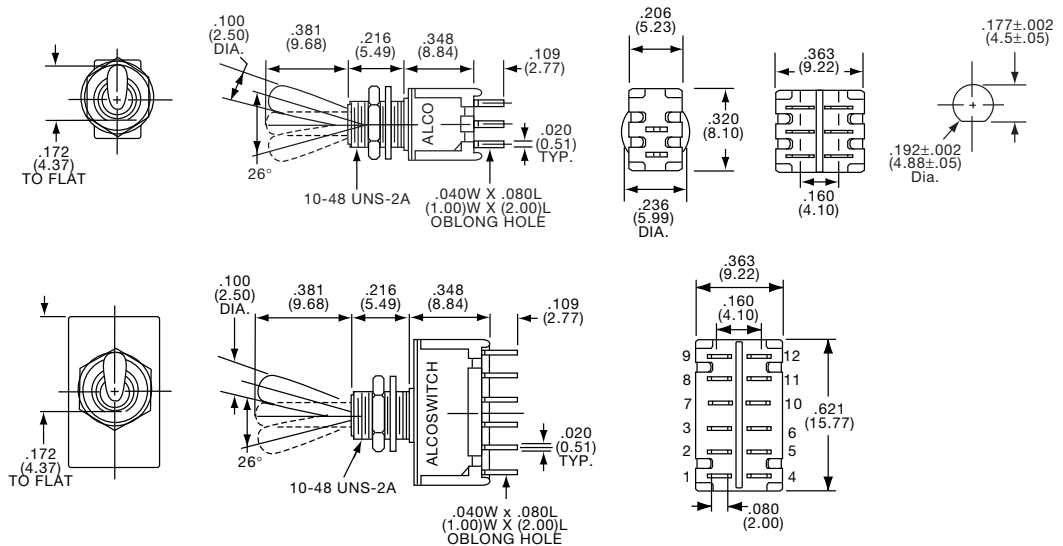

| Tyco Electronics | Alcoswitch | Type | Act. Code | P. M5 | On | None | Off | Tyco Electronics | Alcoswitch | Type | Act. Code | P. M5 | On | None | Off |
|------------------|------------|------|-----------|-------|----|------|-----|------------------|------------|------|-----------|-------|----|------|-----|
| 8-1437561-0      | TT13A3T    | SPST | A         |       | On | None | Off | 5-1437562-8      | TT23P3T    | DPDT | P         |       | On | Off  | On  |
| 8-1437561-8      | TT13D3T    | SPDT | D         |       | On | None | On  | 7-1437562-7      | TT43N3T    | 4PDT | N         |       | On | None | On  |
| 9-1437561-6      | TT13E3T    | SPDT | E         |       | On | Off  | On  | 8-1437562-0      | TT43P3T    | 4PDT | P         |       | On | Off  | On  |
| 4-1437562-8      | TT23K3T    | DPST | K         |       | On | None | Off |                  |            |      |           |       |    |      |     |
| 5-1437562-2      | TT23N3T    | DPDT | N         |       | On | None | On  |                  |            |      |           |       |    |      |     |

Note: No center terminal on "A" or "K" action switches.

1 & 2 POLE



TT13A9T1/4



TT23N9T1/4

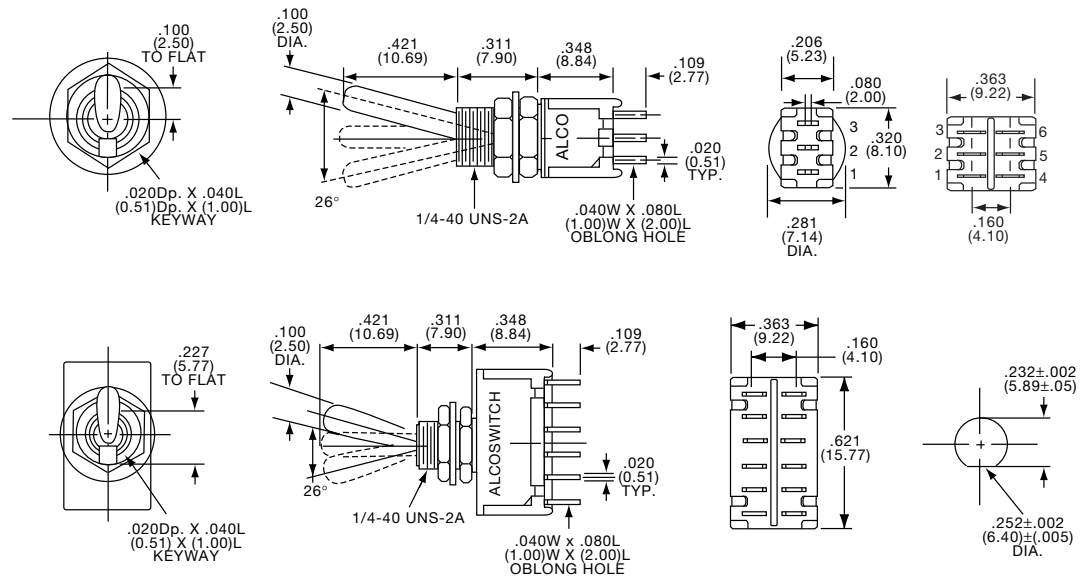

| Tyco Electronics | Alcoswitch | Type | Act. Code | P. M5 | On | None | Off | Tyco Electronics | Alcoswitch | Type | Act. Code | P. M5 | On | None | Off |
|------------------|------------|------|-----------|-------|----|------|-----|------------------|------------|------|-----------|-------|----|------|-----|
| 8-1437561-4      | TT13A9T1/4 | SPST | A         |       | On | None | Off | 6-1437562-2      | TT23P9T1/4 | DPDT | P         |       | On | Off  | On  |
| 9-1437561-2      | TT13D9T1/4 | SPDT | D         |       | On | None | On  | 7-1437562-9      | TT43N9T1/4 | 4PDT | N         |       | On | None | On  |
| 9-1437561-8      | TT13E9T1/4 | SPDT | E         |       | On | Off  | On  | 8-1437562-1      | TT43P9T1/4 | 4PDT | P         |       | On | Off  | On  |
| 4-1437562-9      | TT23K9T1/4 | DPST | K         |       | On | None | Off |                  |            |      |           |       |    |      |     |
| 5-1437562-6      | TT23N9T1/4 | DPDT | N         |       | On | None | On  |                  |            |      |           |       |    |      |     |

Note: No center terminal on "A" or "K" action switches.

4 POLE



TT43N9T1/4



**Toggle Switches, Process Sealed, Vertical**

**MATERIAL SPECIFICATIONS:**

Contacts .....Gold over nickel  
 Inner Case Material .....High temperature polyester  
 Outer Case Material .....Polyamide  
 Terminals/Fixed Contacts .....Tin lead plate  
 Terminal Seal .....Epoxy  
 Process Seal .....Disposable boot, epoxied double case

**TYPICAL PERFORMANCE CHARACTERISTICS:**

Contact Rating .....0.4VA Max. @ 20 VDC or peak AC  
 Initial Contact Resistance.....20 Milliohms max.  
 Contact Timing.....Break-before-make  
 Insulation Resistance .....1,000 Megohms min. 500 VDC  
 Dielectric Strength .....1,000 Volts RMS @ sea level  
 Plunger/Actuator Travel.....26°  
 Life Expectancy .....See page C8

**ENVIRONMENTAL SPECIFICATIONS**

Operating Temperature .....-22°F to +185°F (-30°C to +85°C)  
 Storage Temperature .....-67°F to +185°F (-55°C to +85°C)  
 Solder Heat Resistance.....See page M3-4

**APPLICATION NOTE: Each switch is provided with a disposable boot used only during cleaning operation.**

**\* Refer to Page C8 for Other Options \***

Note: Hardware included with switch

TT-ES Series

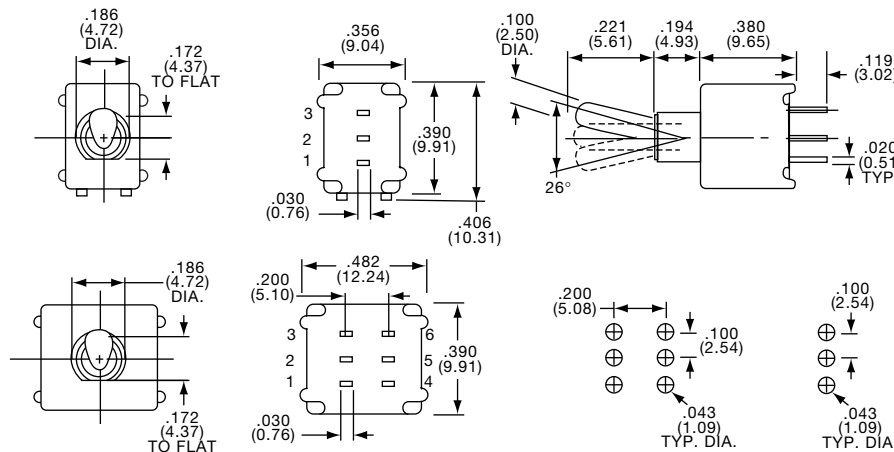

1 & 2 POLE  
UNTHREADED BUSHING



TT11DGPC1ES

| Tyco Electronics | Alcoswitch  | Type | Act. Code P. M5 | On | None | Off | Tyco Electronics | Alcoswitch  | Type | Act. Code P. M5 | On | None | On |
|------------------|-------------|------|-----------------|----|------|-----|------------------|-------------|------|-----------------|----|------|----|
| 2-1437561-4      | TT11AGPC1ES | SPST | A               | On | None | Off | 1437562-4        | TT21NGPC1ES | DPDT | N               | On | None | On |
| 2-1437561-7      | TT11DGPC1ES | SPDT | D               | On | None | On  |                  |             |      |                 |    |      |    |

Note: No center terminal "A".

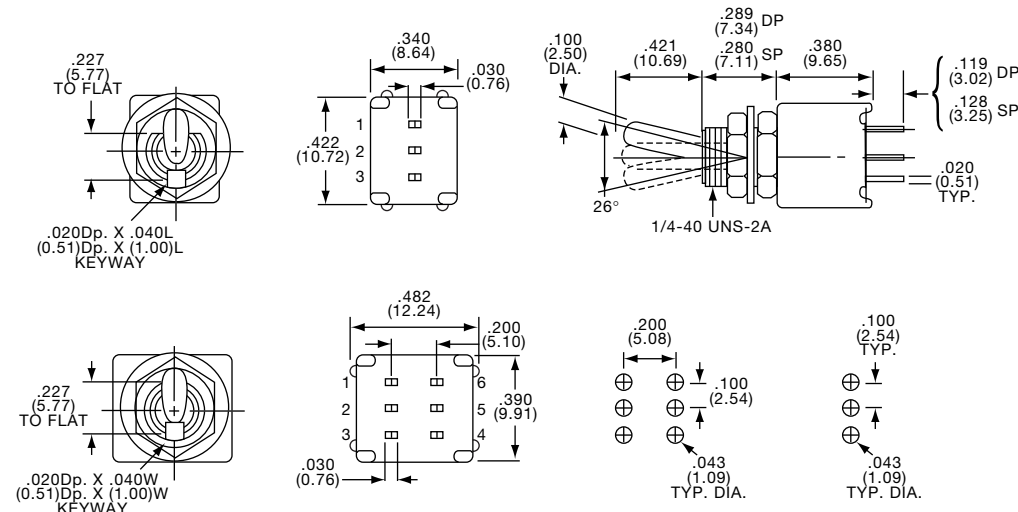

1 & 2 POLE  
THREADED BUSHING



TT11DGPC9T1/4ES



TT21NGPC9T1/4ES

| Tyco Electronics | Alcoswitch      | Type | Act. Code P. M5 | On | None | Off  | Tyco Electronics | Alcoswitch      | Type | Act. Code P. M5 | On | None | On |
|------------------|-----------------|------|-----------------|----|------|------|------------------|-----------------|------|-----------------|----|------|----|
|                  | TT11AGPC9T1/4ES | SPST | A               | On | None | Off  | 1-1437562-2      | TT21NGPC9T1/4ES | DPDT | N               | On | None | On |
| 6-1437830-2      | TT11DGPC9T1/4ES | SPDT | D               | On | None | On   |                  | TT21PGPC9T1/4ES | DPDT | P               | On | Off  | On |
|                  | TT11EGPC9T1/4ES | SPDT | E               | On | Off  | (On) |                  |                 |      |                 |    |      |    |
|                  | TT21KGPC9T1/4ES | DPST | K               | On | None | Off  |                  |                 |      |                 |    |      |    |

Note: No center terminal "A" or "K" action switches.  
 (On) indicates momentary position.

**Toggle Switches, Tiny, Enviromental and Process Sealed**

SEE PAGE C16 FOR PRODUCT SPECIFICATIONS

For terminal connections refer to Code Chart on page M5-6

**1 POLE-PC VERTICAL MOUNT**

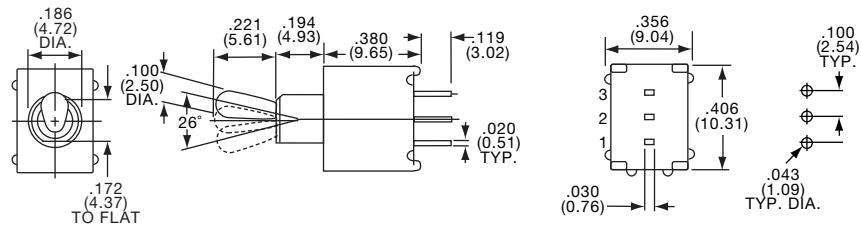

| Tyco Electronics | Alcoswitch   | Type | Act. Code P. M5 |    |      |    |
|------------------|--------------|------|-----------------|----|------|----|
| 8-1437562-6      | TTE11DGPC1ES | SPDT | D               | On | None | On |
|                  | TTE11EGPC1ES | SPDT | E               | On | Off  | On |

**2 POLE-PC VERTICAL MOUNT**

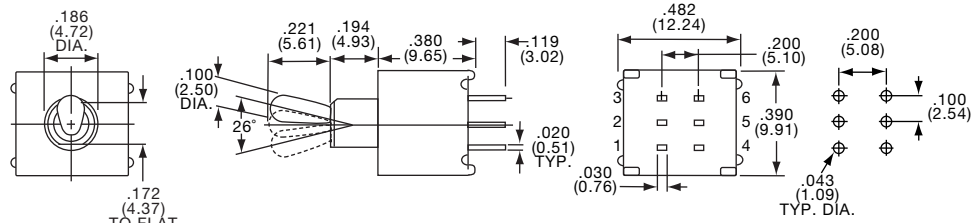

| Tyco Electronics | Alcoswitch   | Type | Act. Code P. M5 |    |      |    |
|------------------|--------------|------|-----------------|----|------|----|
| 1437563-1        | TTE21NGPC1ES | DPDT | N               | On | None | On |
|                  | TTE21PGPC1ES | DPDT | P               | On | Off  | On |

**1 POLE-PC RIGHT ANGLE**



TTE11DGRA1ES  
Horizontal Actuation

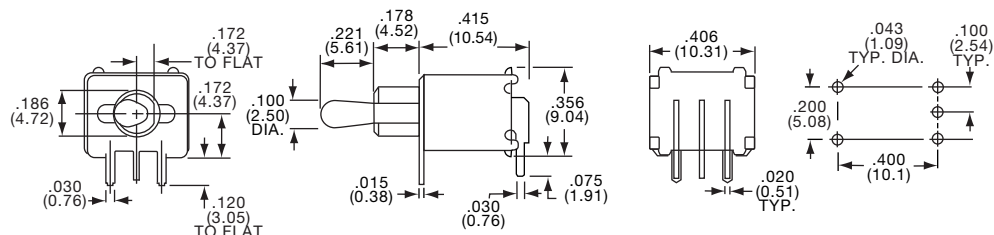

| Tyco Electronics | Alcoswitch   | Type | Act. Code P. M5 |    |      |    |
|------------------|--------------|------|-----------------|----|------|----|
| 8-1437562-9      | TTE11DGRA1ES | SPDT | D               | On | None | On |
| 9-1437562-2      | TTE11EGRA1ES | SPDT | E               | On | Off  | On |

**2 POLE-PC RIGHT ANGLE**



TTE21NGRA1ES  
Horizontal Actuation

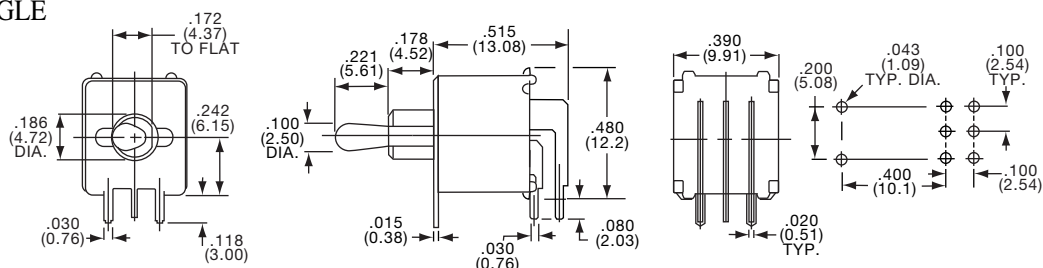

| Tyco Electronics | Alcoswitch   | Type | Act. Code P. M5 |    |      |    |
|------------------|--------------|------|-----------------|----|------|----|
| 1437563-4        | TTE21NGRA1ES | DPDT | N               | On | None | On |
|                  | TTE21PGRA1ES | DPDT | P               | On | Off  | On |

**Toggle Switches, Tiny, Enviromental and Process Sealed**

For terminal connections refer to Code Chart on page M5-6.

SEE PAGE C16 FOR PRODUCT SPECIFICATIONS

\* Refer to Page C8 for Other Options \*

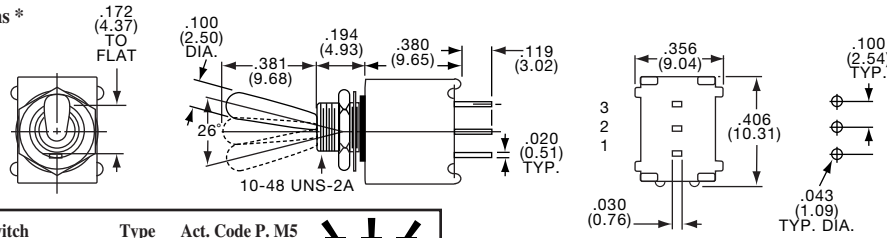

1 POLE



TTE11DGPC3TES

| Tyco Electronics | Alcoswitch    | Type | Act. Code | P. M5 | On | None | Off |
|------------------|---------------|------|-----------|-------|----|------|-----|
| 8-1437562-5      | TTE11AGPC3TES | SPST | A         |       | On | None | Off |
| 8-1437562-7      | TTE11DGPC3TES | SPDT | D         |       | On | None | On  |
| 9-1437562-0      | TTE11EGPC3TES | SPDT | E         |       | On | Off  | On  |

Note: No center terminal on "A" action switches.

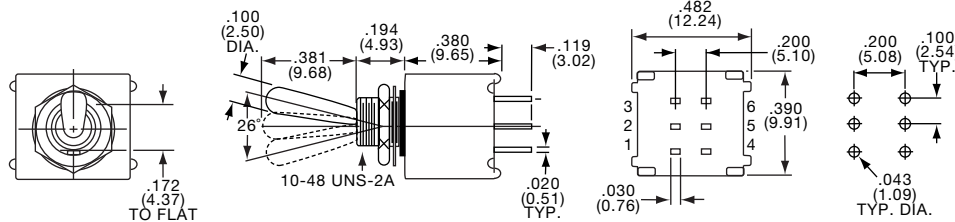

2 POLE



TTE21NGPC3TES

| Tyco Electronics | Alcoswitch    | Type | Act. Code | P. M5 | On | None | On |
|------------------|---------------|------|-----------|-------|----|------|----|
| 1437563-2        | TTE21NGPC3TES | DPDT | N         |       | On | None | On |
|                  | TTE21PGPC3TES | DPDT | P         |       | On | Off  | On |

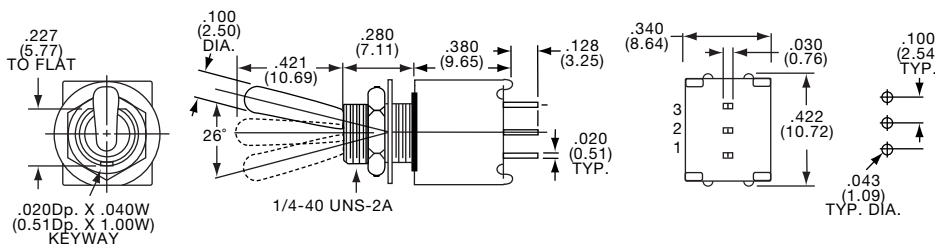

1 POLE



TTE11DGPC9T4ES

| Tyco Electronics | Alcoswitch       | Type | Act. Code | P. M5 | On | None | Off |
|------------------|------------------|------|-----------|-------|----|------|-----|
|                  | TTE11AGPC9T1/4ES | SPST | A         |       | On | None | Off |
| 8-1437562-8      | TTE11DGPC9T1/4ES | SPDT | D         |       | On | None | On  |
| 9-1437562-1      | TTE11EGPC9T1/4ES | SPDT | E         |       | On | Off  | On  |

Note: No center terminal on "A" action switches.

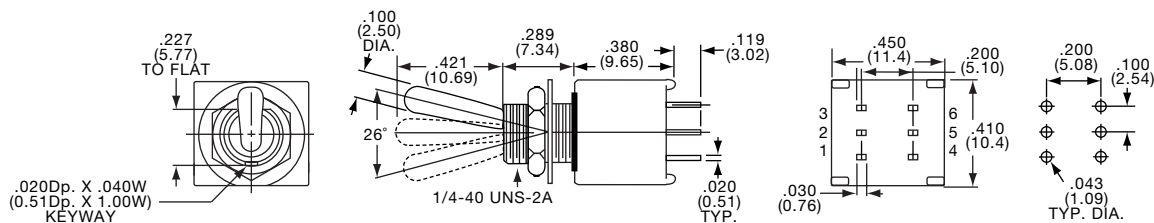

2 POLE



TTE21NGPC9T4ES

| Tyco Electronics | Alcoswitch       | Type | Act. Code | P. M5 | On | None | Off |
|------------------|------------------|------|-----------|-------|----|------|-----|
|                  | TTE21KGPC9T1/4ES | DPST | K         |       | On | None | Off |
| 1437563-3        | TTE21NGPC9T1/4ES | DPDT | N         |       | On | None | On  |
|                  | TTE21PGPC9T1/4ES | DPDT | P         |       | On | Off  | On  |

Note: No center terminal on "K" action switches.

## Данный компонент на территории Российской Федерации

### Вы можете приобрести в компании MosChip.

Для оперативного оформления запроса Вам необходимо перейти по данной ссылке:

<http://moschip.ru/get-element>

Вы можете разместить у нас заказ для любого Вашего проекта, будь то серийное производство или разработка единичного прибора.

В нашем ассортименте представлены ведущие мировые производители активных и пассивных электронных компонентов.

Нашей специализацией является поставка электронной компонентной базы двойного назначения, продукции таких производителей как XILINX, Intel (ex.ALTERA), Vicor, Microchip, Texas Instruments, Analog Devices, Mini-Circuits, Amphenol, Glenair.

Сотрудничество с глобальными дистрибьюторами электронных компонентов, предоставляет возможность заказывать и получать с международных складов практически любой перечень компонентов в оптимальные для Вас сроки.

На всех этапах разработки и производства наши партнеры могут получить квалифицированную поддержку опытных инженеров.

Система менеджмента качества компании отвечает требованиям в соответствии с ГОСТ Р ИСО 9001, ГОСТ РВ 0015-002 и ЭС РД 009

### Офис по работе с юридическими лицами:

105318, г.Москва, ул.Щербаковская д.3, офис 1107, 1118, ДЦ «Щербаковский»

Телефон: +7 495 668-12-70 (многоканальный)

Факс: +7 495 668-12-70 (доб.304)

E-mail: [info@moschip.ru](mailto:info@moschip.ru)

Skype отдела продаж:

moschip.ru

moschip.ru\_4

moschip.ru\_6

moschip.ru\_9