

Description

The AH5792 is a single chip solution for driving single-coil brush-less DC fans and motors. The AH5792 employs a bidirectional full bridge driver output stage for single coil fan motor applications. The device includes features such as Rotor Lock Protection with rotor lock detection and automatic self-restart to avoid damage to the coil when the rotor is blocked.

The AH5792 also offers an externally controlled Tachometer (Frequency Generator Pin) open -drain output which makes it easier to connect with external interface such as hardware monitoring. The FG is half (1/2) the magnetic change frequency.

The devices are packaged in SOT553 and SOT89-5L small outline packages for applications such as small motors like vibration motors or ultra thin cooling fans.

Features

- Support single-phase full wave min fan driver
- Built-in Hall sensor input amplifier
- Low voltage startup (V_{dd}=1.8V)
- Lock detection and automatic self-restart
- Without external timing capacitor, Reduces the numbers of external component required
- FG output
- Low profile package : SOT553 and SOT89-5L
- “Green” Molding Compound

Pin Assignments

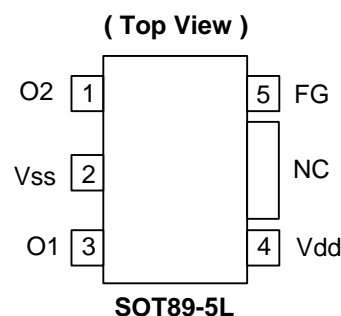
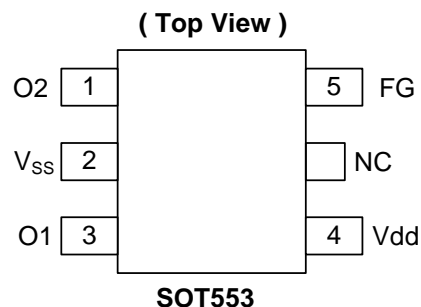

Applications

- 3.3V / 5V Min. DC Fans (Eight Pole)
- Low Voltage / BLDC Motors
- Micro-Vibration Motors

Typical Application Circuit (Note 1)

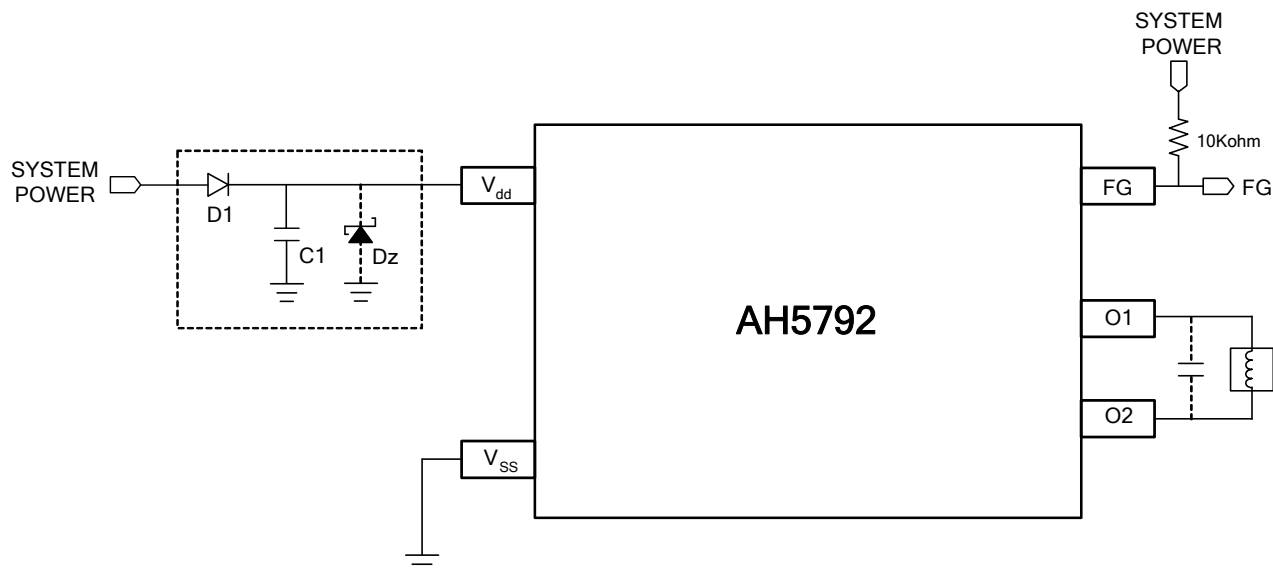

- Notes: 1. Reverse connection of power supply may break the device. A countermeasure is needed such as using reverse power protection diode D1 between power supply and Vdd terminal. In such case of using reverse power protection diode D1 because of there is no way to return current to power supply, please take necessary measures like below.
- Connect Dz (Zener diode) between Vdd and Vss terminal, not to exceed the absolute maximum rating voltage.
 - Connect a capacitor C1 between Vdd and Vss terminal, to make the path of return current to power supply.
- The AH5792 has an open-drain tachometer FG output that follows the half (1/2) the magnetic change frequency. A pull-up resistor (10Kohm, typically for System Power = 5V) connected to a supply voltage.

Pin Descriptions (Note 2)

Pin Name	Description
O1	Output driving & sinking pin 1
Vdd	Power supply pin
Vss	Ground pin
FG	Frequency Generator (Note 2)
O2	Output driving & sinking Pin 2
NC	No Connection

- Notes: 2. The FG is half (1/2) the magnetic change frequency.

Functional Block Diagram

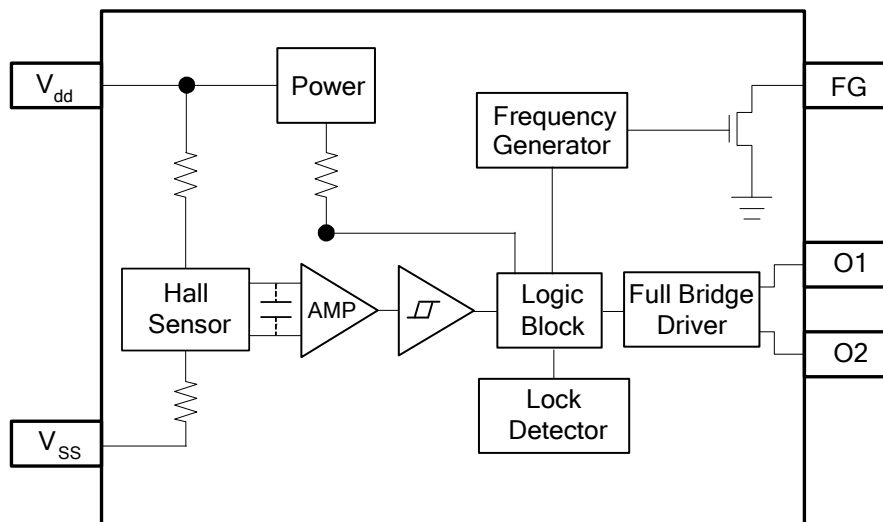

Operating (Note 3, 4, 5)

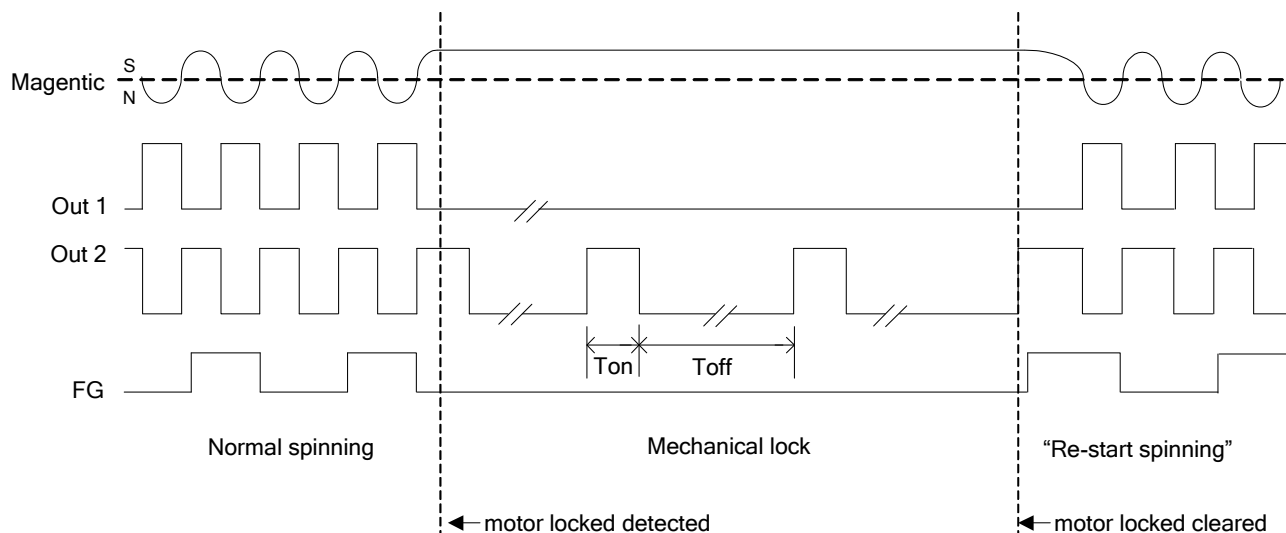

- Notes:
- In "Normal spinning, the FG shall change its state at each rising edge of OUT2. In "Mechanical lock", the FG state is kept as the same as the moment of motor locked detected.
 - When magnetic is locked as "S" pole, then out1 is kept on "L", out2 is a clock with T_{on}/T_{off} ratio. When magnetic is locked at "N" pole, then out 2 is kept on "L", out 1 is a clock with T_{on}/T_{off} ratio.
 - When "Re-start spinning" occurs, the motor shall ramp up to the "Normal Spinning" speed from zero. It depends on the motor characteristics.

SINGLE PHASE HALL EFFECT LATCH SMART FAN MOTOR CONTROLLER

Absolute Maximum Ratings ($T_A = 25^\circ\text{C}$, unless otherwise noted)

Symbol	Characteristics	Values	Unit
V _{DD}	Supply voltage	6	V
I _{O(PEAK)}	Maximum Output Current (Peak)	SOT553	400 mA
		SOT89-5L	500 mA
P _D	Power Dissipation	SOT553	230 mW
		SOT89-5L	800 mW
T _{ST}	Storage Temperature Range	-65 ~ 150	°C

Recommended Operating Conditions ($T_A = 25^\circ\text{C}$)

Symbol	Parameter	Conditions	Rating	Unit
V _{DD}	Supply Voltage	Operating	1.8 to 5.0	V
T _A	Operating Temperature Range	Operating	-40 to +100	°C

Electrical Characteristics ($T_A = 25^\circ\text{C}$, V_{DD} = 5.0V)

Symbol	Characteristic	Conditions	Min	Typ.	Max	Unit
I _{DD}	Supply Current	No Load	-	3.5	5	mA
V _{OH}	Output Voltage High	I _{OUT} = 200mA (For SOT553)	4.4	-	-	V
		I _{OUT} = 300mA (For SOT89-5L)				
V _{OL}	Output Voltage Low	I _{OUT} = 200mA (For SOT553)	-	-	0.6	V
		I _{OUT} = 300mA (For SOT89-5L)				
I _{OUT}	Output Current	R _L = 30Ω	-	148	-	mA
I _{Leak}	FG Output Leakage Current		-	-	5	μA
I _{FG}	FG Output Current	V _{FGOL} = 0.4V	5	-	-	mA
V _{FGOL}	FG Output Voltage Low	I _{FG} = 5mA	-	-	0.4	V
T _{ON}	On Time		-	215	-	ms
R _{DR}	Duty Ratio	T _{OFF} / T _{ON}	-	10	-	

Magnetic Characteristics ($T_A = 25^\circ\text{C}$, $V_{dd} = 1.8\text{V}\sim 5.0\text{V}$, Note 6)

(1mT = 10 G)

Symbol	Parameter	Min	Typ.	Max	Unit
B_{op}	Operate Point	10	30	50	G
B_{rp}	Release Point	-50	-30	-10	G
B_{hy}	Hysteresis	-	60	-	G

Notes: 6. The magnetic characteristics may vary with supply voltage, operating temperature and after soldering.

Operating Characteristics

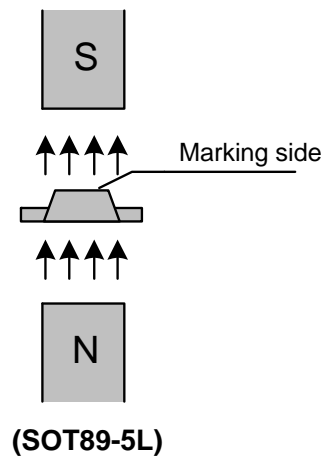
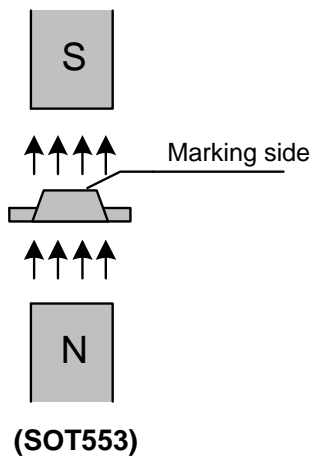
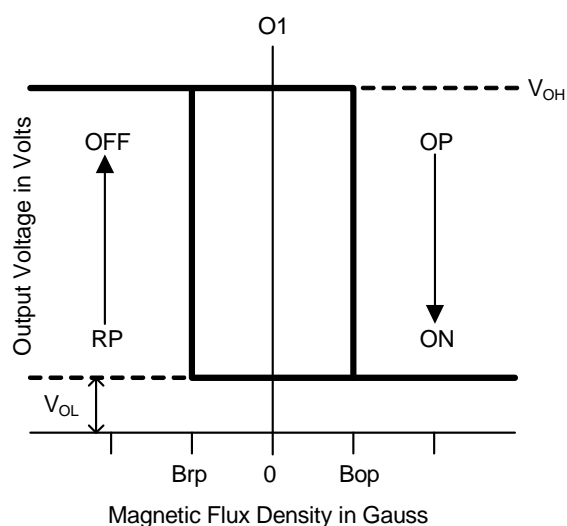
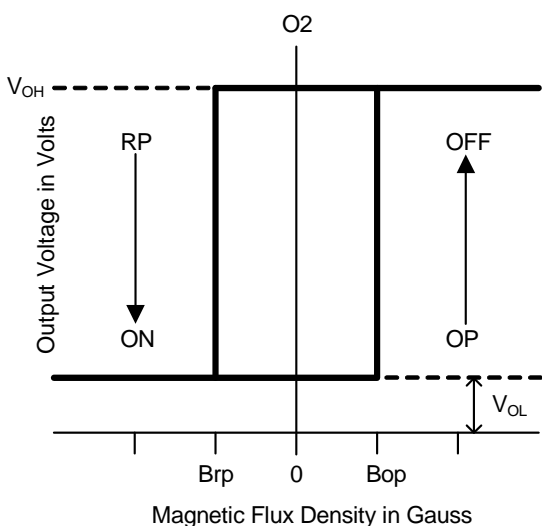

Performance Characteristics

(1) SOT553

T _A (°C)	25	50	60	70	80	85	90	100	110	120	130	140	150
P _D (mW)	230	184	166	147	129	120	110	92	74	55	37	18	0

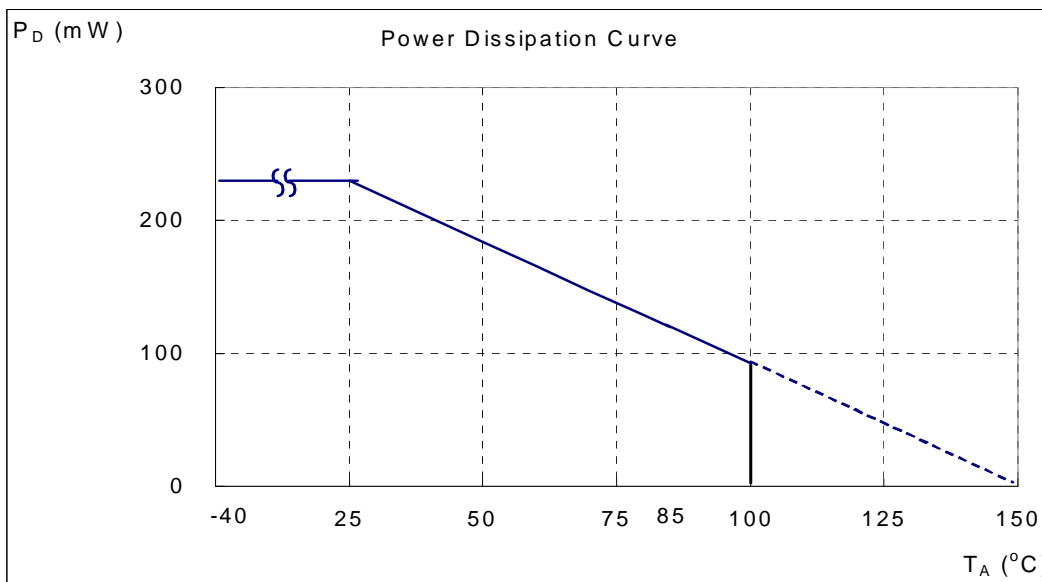

(2) SOT89-5L

T _A (°C)	25	50	60	70	75	80	85	90	95	100
P _D (mW)	800	640	576	512	480	448	416	384	352	320
T _A (°C)	105	110	115	120	125	130	135	140	145	150
P _D (mW)	288	256	224	192	160	128	96	64	32	0

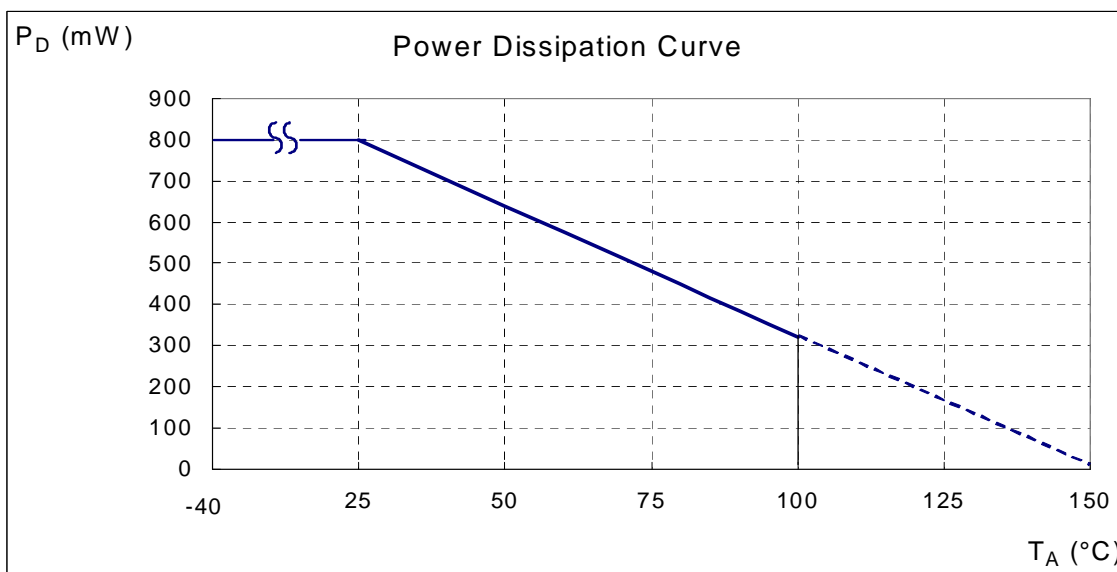

Ordering Information

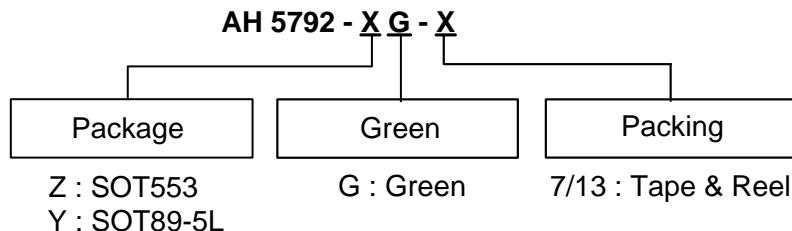

Device	Package Code	Packaging (Note 7 & 8)	7"/13" Tape and Reel	
			Quantity	Part Number Suffix
AH5792-ZG-7	Z	SOT553	3000/Tape & Reel	-7
AH5792-YG-13	Y	SOT89-5L	2500/Tape & Reel	-13

Notes: 7. Pad layout as shown on Diodes Inc. suggested pad layout document AP02001, which can be found on our website at <http://www.diodes.com/datasheets/ap02001.pdf>
 8. EU Directive 2002/95/EC (RoHS). All applicable RoHS exemptions applied. Please visit our website at http://www.diodes.com/products/lead_free.html

Marking Information

(1) SOT553

(Top View)

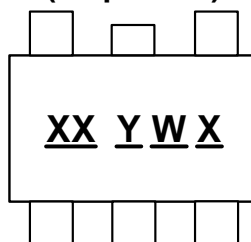

XX : Identification Code
Y : Year : 0~9
W : Week : A~Z : 1~26 week;
 a~z : 27~52 week;
 z represents 52 and 53 week
X : A~Z : Green

Part Number	Package	Identification Code
AH5792	SOT553	KE

(2) SOT89-5L

(Top View)

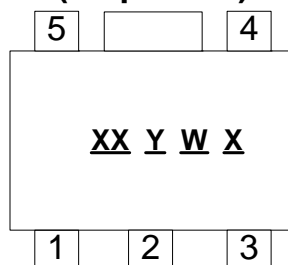

XX : Identification code
Y : Year : 0~9
W : Week : A~Z : 1~26 week;
 a~z : 27~52 week;
 z represents 52 and 53 week
X : Internal code
 A~Z : Green

Part Number	Package	Identification Code
AH5792	SOT89-5L	KF

Package Outline Dimensions (All Dimensions in mm)

(1) Package Type: SOT553

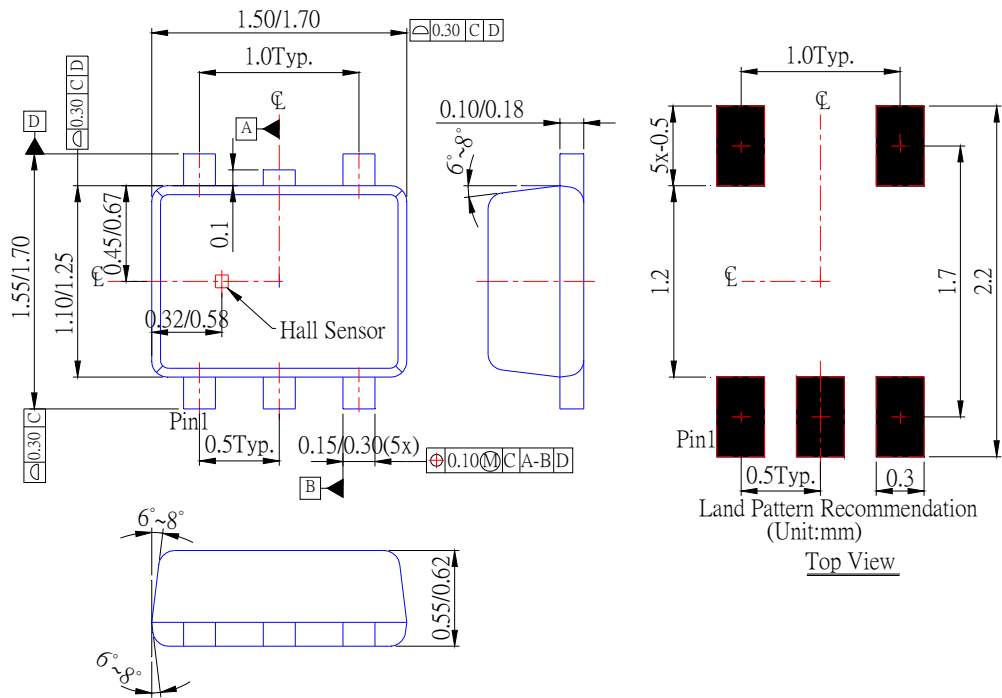

Package Outline Dimensions (Continued)

(2) Package type: SOT89-5L

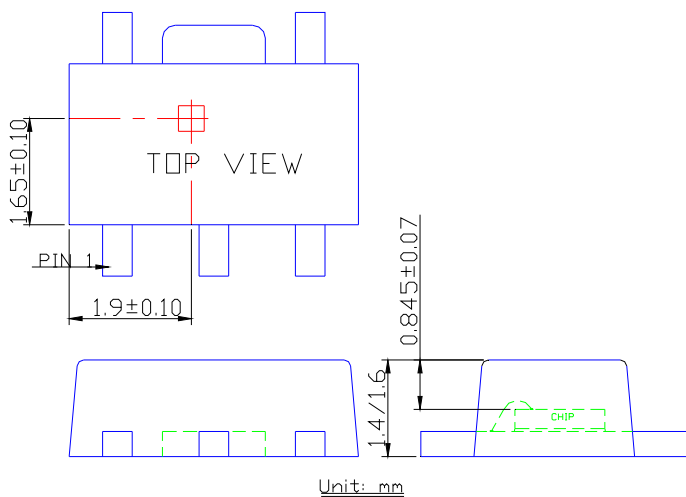
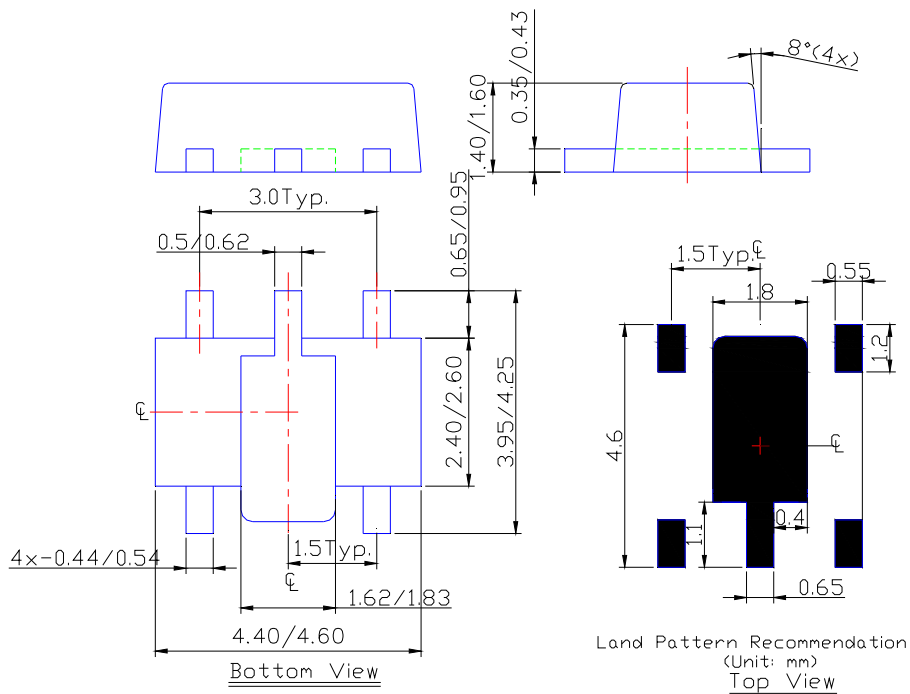

Sensor Location

IMPORTANT NOTICE

DIODES INCORPORATED MAKES NO WARRANTY OF ANY KIND, EXPRESS OR IMPLIED, WITH REGARDS TO THIS DOCUMENT, INCLUDING, BUT NOT LIMITED TO, THE IMPLIED WARRANTIES OF MERCHANTABILITY AND FITNESS FOR A PARTICULAR PURPOSE (AND THEIR EQUIVALENTS UNDER THE LAWS OF ANY JURISDICTION).

Diodes Incorporated and its subsidiaries reserve the right to make modifications, enhancements, improvements, corrections or other changes without further notice to this document and any product described herein. Diodes Incorporated does not assume any liability arising out of the application or use of this document or any product described herein; neither does Diodes Incorporated convey any license under its patent or trademark rights, nor the rights of others. Any Customer or user of this document or products described herein in such applications shall assume all risks of such use and will agree to hold Diodes Incorporated and all the companies whose products are represented on Diodes Incorporated website, harmless against all damages.

Diodes Incorporated does not warrant or accept any liability whatsoever in respect of any products purchased through unauthorized sales channel.

Should Customers purchase or use Diodes Incorporated products for any unintended or unauthorized application, Customers shall indemnify and hold Diodes Incorporated and its representatives harmless against all claims, damages, expenses, and attorney fees arising out of, directly or indirectly, any claim of personal injury or death associated with such unintended or unauthorized application.

Products described herein may be covered by one or more United States, international or foreign patents pending. Product names and markings noted herein may also be covered by one or more United States, international or foreign trademarks.

LIFE SUPPORT

Diodes Incorporated products are specifically not authorized for use as critical components in life support devices or systems without the express written approval of the Chief Executive Officer of Diodes Incorporated. As used herein:

- A. Life support devices or systems are devices or systems which:
1. are intended to implant into the body, or
 2. support or sustain life and whose failure to perform when properly used in accordance with instructions for use provided in the labeling can be reasonably expected to result in significant injury to the user.
- B. A critical component is any component in a life support device or system whose failure to perform can be reasonably expected to cause the failure of the life support device or to affect its safety or effectiveness.

Customers represent that they have all necessary expertise in the safety and regulatory ramifications of their life support devices or systems, and acknowledge and agree that they are solely responsible for all legal, regulatory and safety-related requirements concerning their products and any use of Diodes Incorporated products in such safety-critical, life support devices or systems, notwithstanding any devices- or systems-related information or support that may be provided by Diodes Incorporated. Further, Customers must fully indemnify Diodes Incorporated and its representatives against any damages arising out of the use of Diodes Incorporated products in such safety-critical, life support devices or systems.

Copyright © 2010, Diodes Incorporated

www.diodes.com

Данный компонент на территории Российской Федерации

Вы можете приобрести в компании MosChip.

Для оперативного оформления запроса Вам необходимо перейти по данной ссылке:

<http://moschip.ru/get-element>

Вы можете разместить у нас заказ для любого Вашего проекта, будь то серийное производство или разработка единичного прибора.

В нашем ассортименте представлены ведущие мировые производители активных и пассивных электронных компонентов.

Нашей специализацией является поставка электронной компонентной базы двойного назначения, продукции таких производителей как XILINX, Intel (ex.ALTERA), Vicor, Microchip, Texas Instruments, Analog Devices, Mini-Circuits, Amphenol, Glenair.

Сотрудничество с глобальными дистрибьюторами электронных компонентов, предоставляет возможность заказывать и получать с международных складов практически любой перечень компонентов в оптимальные для Вас сроки.

На всех этапах разработки и производства наши партнеры могут получить квалифицированную поддержку опытных инженеров.

Система менеджмента качества компании отвечает требованиям в соответствии с ГОСТ Р ИСО 9001, ГОСТ РВ 0015-002 и ЭС РД 009

Офис по работе с юридическими лицами:

105318, г.Москва, ул.Щербаковская д.3, офис 1107, 1118, ДЦ «Щербаковский»

Телефон: +7 495 668-12-70 (многоканальный)

Факс: +7 495 668-12-70 (доб.304)

E-mail: info@moschip.ru

Skype отдела продаж:

moschip.ru

moschip.ru_4

moschip.ru_6

moschip.ru_9