

HLMP-DB25, HLMP-KB45

T-1¾ (5 mm), T-1 (3 mm)

Blue LED Lamps



Data Sheet

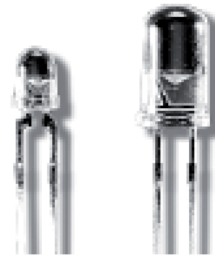

Description

These blue LEDs are designed in industry standard T-1 and T-1¾ package with clear and non diffused optics. They are also available in tape and reel, and ammo-pack option for ease of handling and use.

These blue lamps are ideal for use as indicators and for general purpose lighting. Blue lamps offer color differentiation as blue is attractive and not widely available.

Features

- Popular T-1¾ and T-1 diameter packages
- General purpose leads
- Reliable and rugged
- Available on tape and reel
- Binned for color and intensity

Applications

- Status indicators
- Small message panel
- Running and decorative lights for commercial use

Package Dimensions

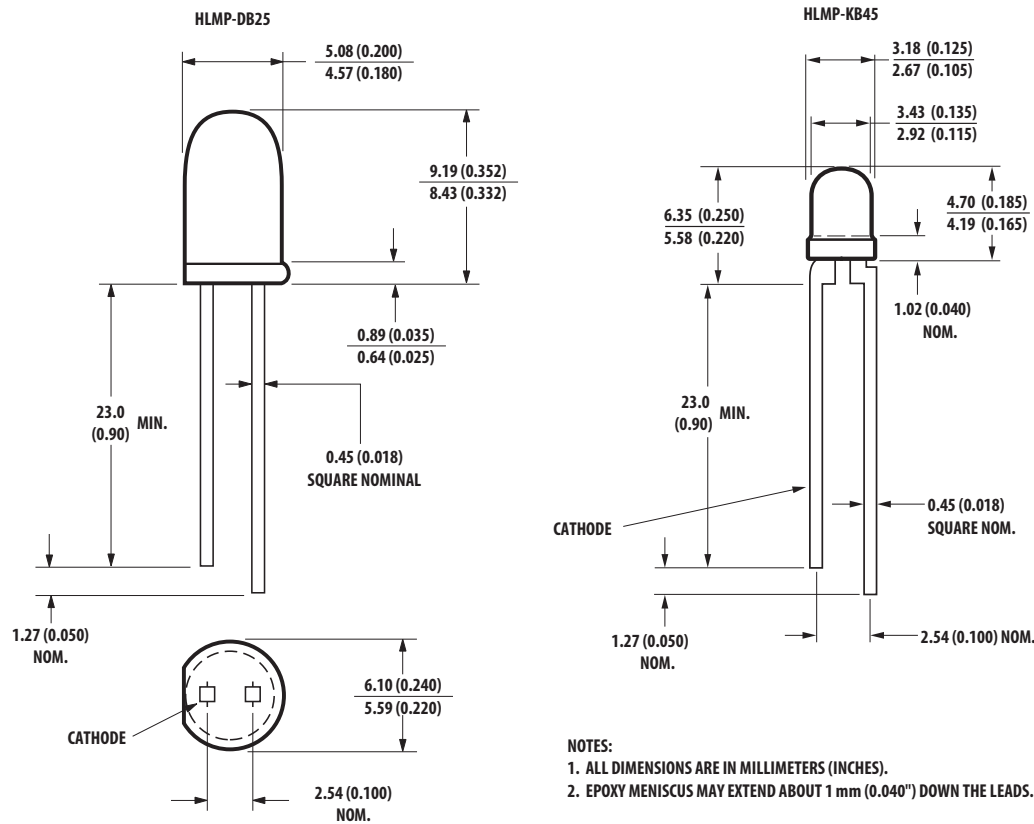

CAUTION: Devices are Class I ESD sensitive. Please observe appropriate precautions during handling and processing. Refer to Application Note AN-1142 for additional details.

Selection Guide

Part Number	Package	Viewing Angle	Luminous Intensity I _v (mcd)	
			Min.	Max.
HLMP-KB45-A00xx	T-1	40	30	–
HLMP-DB25-B00xx	T-1¾	25	40	–

Part Numbering System

HLMP - x x xx - x x x xx

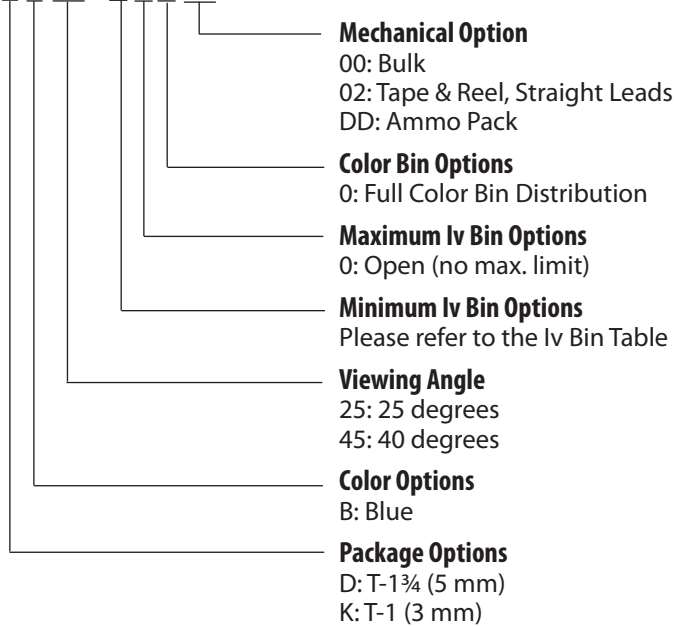

Absolute Maximum Ratings at T_A = 25°C

Parameter	Blue	Units
Peak Forward Current	70	mA
DC Current ^[1]	30	mA
Reverse Voltage	Not recommended for reverse bias	
Transient Forward Current ^[2] (10 µsec Pulse)	350	mA
LED Junction Temperature	115	°C
Operating Temperature	-20 to +80	°C
Storage Temperature	-30 to +100	°C
Wave Soldering Temperature [1.59 mm (0.063 in.) from Body]µ	250°C for 3 seconds	
Solder Dipping Temperature [1.59 mm (0.063 in.) from Body]	260°C for 5 seconds	

Notes:

- Derate linearly from 50°C as shown in Figure 6.
- The transient peak current is the maximum non-recurring peak current that can be applied to the device without damaging the LED die and wirebond. It is not recommended that this device be operated at peak currents above the Absolute Maximum Peak Forward Current.

Optical Characteristics at $T_A = 25^\circ\text{C}$

Part Number	Luminous Intensity I_V (mcd) @ $I_F = 20$ mA		Color, Dominant Wavelength λ_d ^[1] (nm)	Peak Wavelength λ_{PEAK} (nm)	Viewing Angle $2\theta_{1/2}$ ^[2] Degrees
	Min.	Typ.	Typ.	Typ.	Typ.
HLMP-DB25-B00xx	40		470	464	25
HLMP-KB45-A00xx	30		470	464	40

Notes:

- The dominant wavelength, λ_d , is derived from the CIE chromaticity diagram and represents the single wavelength which defines the color of the device.
- $\theta_{1/2}$ is the off-axis angle at which the luminous intensity is half of the axial luminous intensity.

Electrical Characteristics at $T_A = 25^\circ\text{C}$

Part Number	Forward Voltage V_F (Volts) @ $I_F = 20$ mA		Speed Response τ_s (ns)	Capacitance C (pF), $V_F = 0$, $f = 1$ MHz	Thermal Resistance $R_{\theta J-PIN}$ ($^\circ\text{C}/\text{W}$) Junction to Cathode Lead
	Typ.	Max.	Typ.	Typ.	Typ.
HLMP-DB25-B00xx	3.2	3.8	500	97	260
HLMP-KB45-A00xx	3.2	3.8	500	97	290

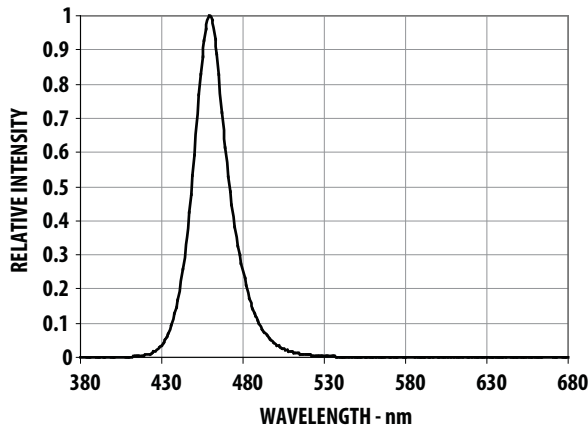

Figure 1. Relative intensity vs. wavelength

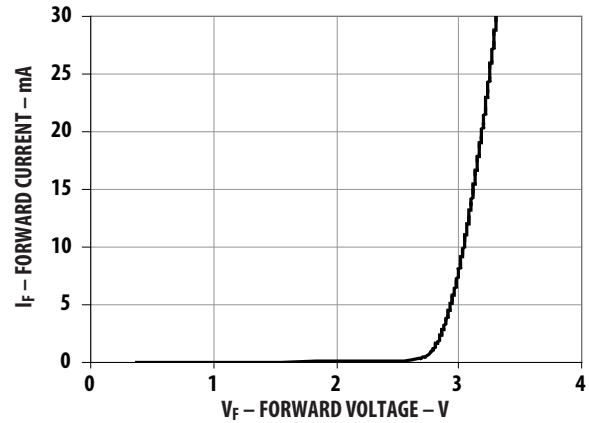

Figure 2. Forward current vs. forward voltage

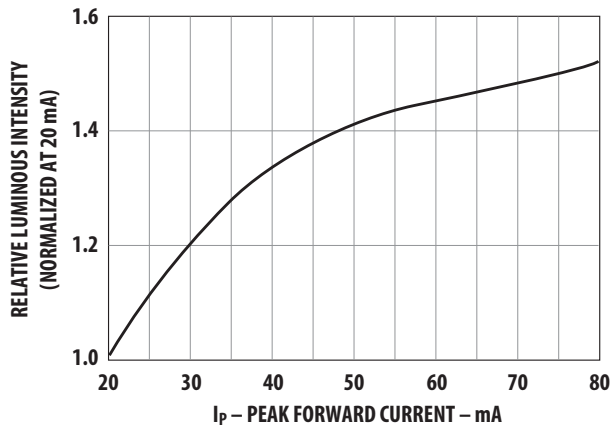

Figure 3. Relative intensity vs. peak forward current (300 μs pulse width, 10 ms period)

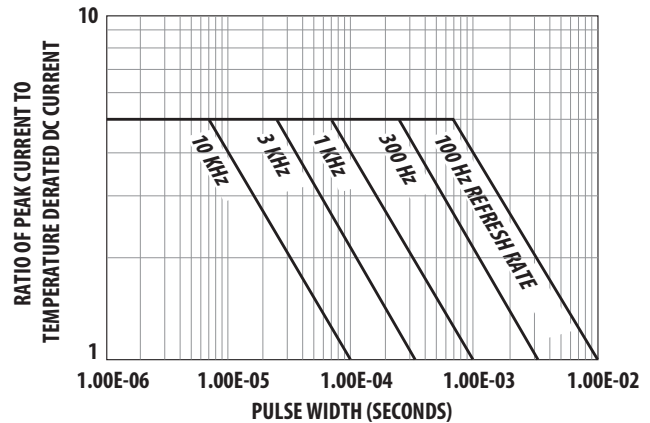

Figure 4. Maximum Tolerable Peak Current vs Pulse Width

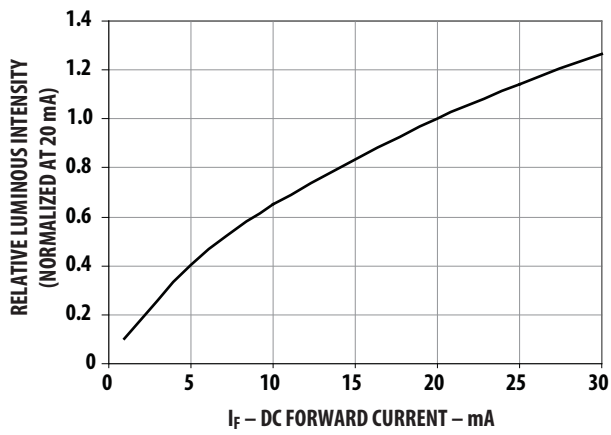

Figure 5. Relative luminous intensity vs. forward current

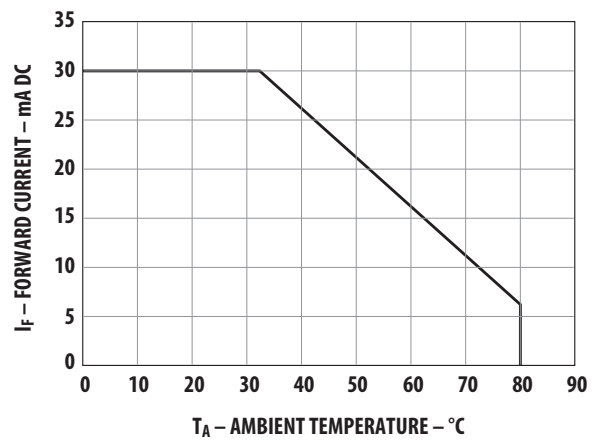

Figure 6. Maximum DC forward current vs. ambient temperature. Derating based on T_J max. = 115°C

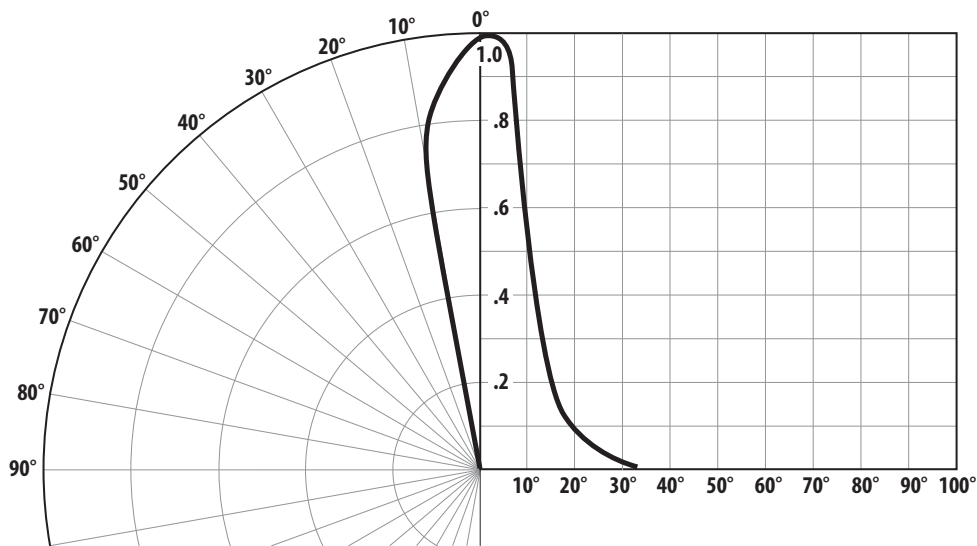

Figure 7. Relative luminous intensity vs. angular displacement for HLMP-DB25

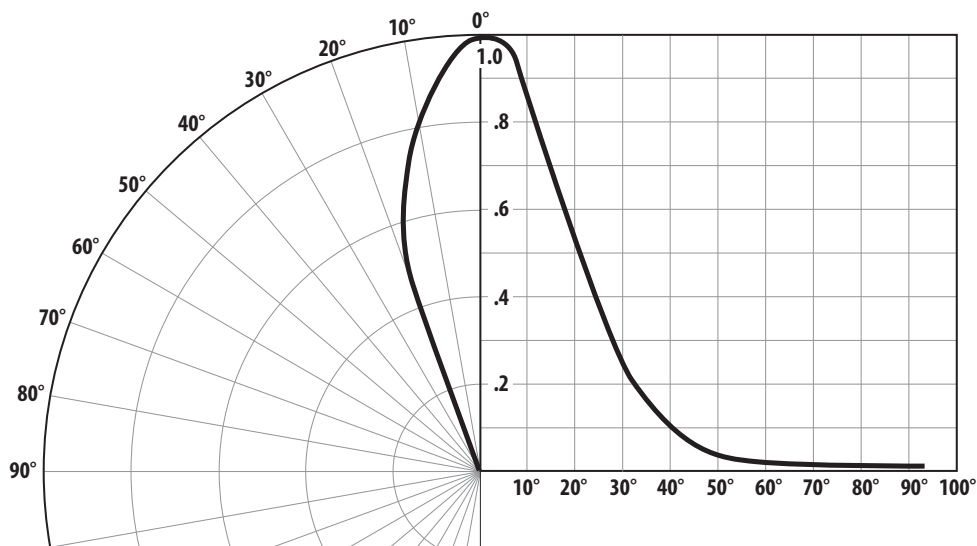

Figure 8. Relative luminous intensity vs. angular displacement for HLMP-KB45

Soldering/Cleaning

Cleaning agents from the ketone family (acetone, methyl ethyl ketone, etc.) and from the chlorinated hydrocarbon family (methylene chloride, trichloro-ethylene, carbon tetrachloride, etc.) are not recommended for cleaning LED parts. All of these various solvents attack or dissolve the encapsulating epoxies used to form the package of plastic LED parts.

Intensity Bin Limits

Bin ID	Intensity Range (mcd)	
	Min	Max
A	30	40
B	40	50
C	50	65
D	65	85
E	85	110
F	110	140
G	140	180
H	180	240
J	240	310
K	310	400
L	400	520
M	520	680
N	680	880
P	880	1150
Q	1150	1500
R	1500	1900
S	1900	2500
T	2500	3200
U	3200	4200

Tolerance for each bin limit is $\pm 15\%$.

Color Bin Limits (nm at 20 mA)

Bin ID	Blue nm @ 20 mA	
	Min.	Max.
1	460.0	464.0
2	464.0	468.0
3	468.0	472.0
4	472.0	476.0
5	476.0	480.0

Tolerance for each bin limit is ± 0.5 nm.

Mechanical Option Matrix

Mechanical Option Code	Definition
00	Bulk Packaging, minimum increment 500 pcs/bag
02	Tape & Reel, straight leads, minimum increment 1300 pcs/reel
DD	Ammo Pack, straight leads with minimum increment 2000pcs/pack

Note:

All categories are established for classification of products. Products may not be available in all categories. Please contact your local Avago representative for further clarification/information.

Precautions:

Lead Forming:

- The leads of an LED lamp may be preformed or cut to length prior to insertion and soldering on PC board.
- For better control, it is recommended to use proper tool to precisely form and cut the leads to applicable length rather than doing it manually.
- If manual lead cutting is necessary, cut the leads after the soldering process. The solder connection forms a mechanical ground which prevents mechanical stress due to lead cutting from traveling into LED package. This is highly recommended for hand solder operation, as the excess lead length also acts as small heat sink.

Soldering and Handling:

- Care must be taken during PCB assembly and soldering process to prevent damage to the LED component.
- LED component may be effectively hand soldered to PCB. However, it is only recommended under unavoidable circumstances such as rework. The closest manual soldering distance of the soldering heat source (soldering iron's tip) to the body is 1.59mm. Soldering the LED using soldering iron tip closer than 1.59mm might damage the LED.

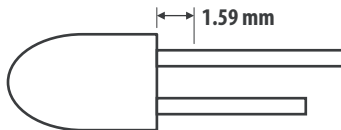

- ESD precaution must be properly applied on the soldering station and personnel to prevent ESD damage to the LED component that is ESD sensitive. Do refer to Avago application note AN 1142 for details. The soldering iron used should have grounded tip to ensure electrostatic charge is properly grounded.
- Recommended soldering condition:

	Wave Soldering^{[1],[2]}	Manual Solder Dipping
Pre-heat Temperature	105°C Max.	–
Pre-heat Time	60 sec Max.	–
Peak Temperature	250°C Max.	260°C Max.
Dwell Time	3 sec Max.	5 sec Max.

Note:

1. Above conditions refers to measurement with thermocouple mounted at the bottom of PCB.
2. It is recommended to use only bottom preheaters in order to reduce thermal stress experienced by LED.

- Wave soldering parameters must be set and maintained according to the recommended temperature and dwell time. Customer is advised to perform daily check on the soldering profile to ensure that it is always conforming to recommended soldering conditions.

Note:

1. PCB with different size and design (component density) will have different heat mass (heat capacity). This might cause a change in temperature experienced by the board if same wave soldering setting is used. So, it is recommended to re-calibrate the soldering profile again before loading a new type of PCB.
 2. Customer is advised to take extra precaution during wave soldering to ensure that the maximum wave temperature does not exceed 250°C and the solder contact time does not exceeding 3sec. Over-stressing the LED during soldering process might cause premature failure to the LED due to delamination.
- Any alignment fixture that is being applied during wave soldering should be loosely fitted and should not apply weight or force on LED. Non metal material is recommended as it will absorb less heat during wave soldering process.
 - At elevated temperature, LED is more susceptible to mechanical stress. Therefore, PCB must allowed to cool down to room temperature prior to handling, which includes removal of alignment fixture or pallet.
 - If PCB board contains both through hole (TH) LED and other surface mount components, it is recommended that surface mount components be soldered on the top side of the PCB. If surface mount need to be on the bottom side, these components should be soldered using reflow soldering prior to insertion the TH LED.
 - Recommended PC board plated through holes (PTH) size for LED component leads.

LED Component Lead Size	Diagonal	Plated Through Hole Diameter
0.45 x 0.45 mm (0.018 x 0.018 inch)	0.636 mm (0.025 inch)	0.98 to 1.08 mm (0.039 to 0.043 inch)
0.50 x 0.50 mm (0.020 x 0.020 inch)	0.707 mm (0.028 inch)	1.05 to 1.15 mm (0.041 to 0.045 inch)

- Over-sizing the PTH can lead to twisted LED after clinching. On the other hand under sizing the PTH can cause difficulty inserting the TH LED.

Refer to application note AN5334 for more information about soldering and handling of TH LED lamps.

Example of Wave Soldering Temperature Profile for TH LED

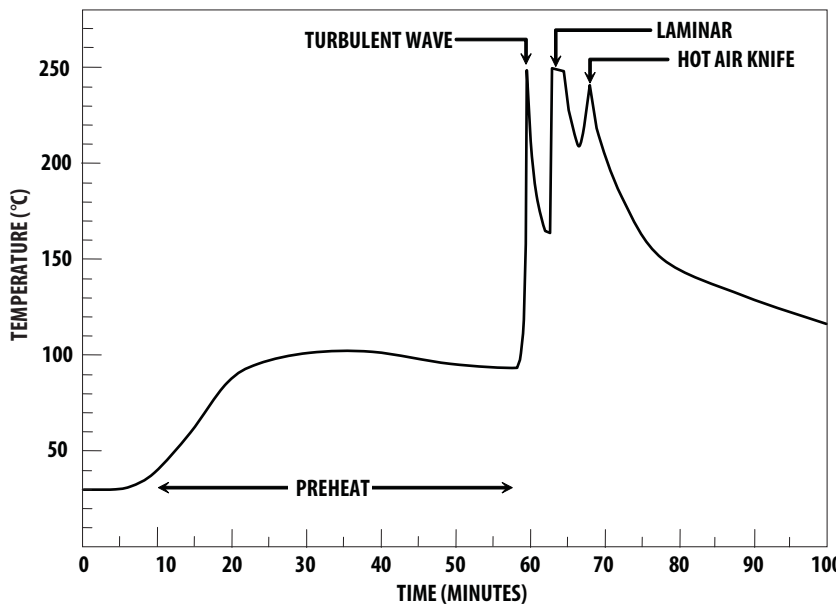

Recommended solder:
Sn63 (Leaded solder alloy)
SAC305 (Lead free solder alloy)

Flux: Rosin flux

Solder bath temperature:
245°C ± 5°C (maximum peak temperature = 250°C)

Dwell time: 1.5 sec – 3.0 sec (maximum = 3sec)

Note: Allow for board to be sufficiently cooled to room temperature before exerting mechanical force.

Recommended solder:
Sn63 (Leaded solder alloy)
SAC305 (Lead free solder alloy)

Flux: Rosin flux

Solder bath temperature:
245°C ± 5°C (maximum peak temperature = 250°C)

Dwell time: 1.5 sec – 3.0 sec (maximum = 3sec)

Note: Allow for board to be sufficiently cooled to room temperature before exerting mechanical force.

Packaging Label:

(i) Avago Mother Label: (Available on packaging box of ammo pack and shipping box)

 TECHNOLOGIES	
(1P) Item: Part Number 	STANDARD LABEL LS0002 RoHS Compliant e3 max temp 250C
(1T) Lot: Lot Number 	(Q) QTY: Quantity 
LPN: 	CAT: Intensity Bin 
(9D)MFG Date: Manufacturing Date 	BIN: Color Bin 
<hr/>	
(P) Customer Item: 	
(V) Vendor ID: 	(9D) Date Code: Date Code 
<hr/>	
DeptID: 	Made In: Country of Origin 

(ii) Avago Baby Label (Only available on bulk packaging)

 Lamps Baby Label		RoHS Compliant e3 max temp 250C
(1P) PART #: Part Number 		
(1T) LOT #: Lot Number 		
(9D)MFG DATE: Manufacturing Date 	QUANTITY: Packing Quantity 	
C/O: Country of Origin		
Customer P/N: 	CAT: Intensity Bin 	
Supplier Code: 	BIN: Color Bin 	
	DATECODE: Date Code 	

For product information and a complete list of distributors, please go to our web site: www.avagotech.com

Avago, Avago Technologies, and the A logo are trademarks of Avago Technologies in the United States and other countries. Data subject to change. Copyright © 2005-2011 Avago Technologies. All rights reserved. Obsoletes 5989-3263EN AV02-2213EN - January 28, 2011



Данный компонент на территории Российской Федерации

Вы можете приобрести в компании MosChip.

Для оперативного оформления запроса Вам необходимо перейти по данной ссылке:

<http://moschip.ru/get-element>

Вы можете разместить у нас заказ для любого Вашего проекта, будь то серийное производство или разработка единичного прибора.

В нашем ассортименте представлены ведущие мировые производители активных и пассивных электронных компонентов.

Нашей специализацией является поставка электронной компонентной базы двойного назначения, продукции таких производителей как XILINX, Intel (ex.ALTERA), Vicor, Microchip, Texas Instruments, Analog Devices, Mini-Circuits, Amphenol, Glenair.

Сотрудничество с глобальными дистрибьюторами электронных компонентов, предоставляет возможность заказывать и получать с международных складов практически любой перечень компонентов в оптимальные для Вас сроки.

На всех этапах разработки и производства наши партнеры могут получить квалифицированную поддержку опытных инженеров.

Система менеджмента качества компании отвечает требованиям в соответствии с ГОСТ Р ИСО 9001, ГОСТ РВ 0015-002 и ЭС РД 009

Офис по работе с юридическими лицами:

105318, г.Москва, ул.Щербаковская д.3, офис 1107, 1118, ДЦ «Щербаковский»

Телефон: +7 495 668-12-70 (многоканальный)

Факс: +7 495 668-12-70 (доб.304)

E-mail: info@moschip.ru

Skype отдела продаж:

moschip.ru

moschip.ru_4

moschip.ru_6

moschip.ru_9