

# Digital Temperature Controller

## E5CC/E5EC/E5AC/E5DC

The new standard in temperature control is higher in every respect

**E5CC (48 × 48 mm) / E5EC (48 × 96 mm) / E5AC (96 × 96 mm)  
E5DC (22.5 mm Wide, and DIN Track-mounting Type)**

Large White PV Display That's Easier to Read.

Easy to Use, from Model Selection to Setup and Operation.

A Complete Range of I/O Capacities, Functions, and Performance.

Handles More Applications.

New Models That Mount to DIN Track and Are Ideal for HMI/PLC Connections.



48 × 48 mm  
**E5CC**

48 × 96 mm  
**E5EC**

96 × 96 mm  
**E5AC**

22.5 mm Wide, and  
DIN Track-mounting Type  
**E5DC**

# Digital Temperature Controller

# E5CC (48 × 48 mm)

**Large White PV Display That's Easier to Read.  
Easy to Use, from Model Selection to  
Setup and Operation.**

**A Complete Range of I/O Capacities,  
Functions, and Performance.  
Handles More Applications.**

- The white PV display with a height of 15.2 mm improves visibility.
- High-speed sampling at 50 ms.
- Models are available with up to 3 auxiliary outputs, up to 4 event inputs, a transfer output, and a remote SP input to cover a wide range of applications.
- Short body with depth of only 60 mm.
- Set up the Controller without wiring the power supply by connecting to the computer with a Communications Conversion Cable (sold separately). Setup is easy with the CX-Thermo (sold separately).
- Easy connections to a PLC with programless communications. Use component communications to link Temperature Controllers to each other.



**48 × 48 mm  
E5CC**

Refer to your OMRON website for the most recent information on applicable safety standards.

Refer to Safety Precautions on page 50.

## Main I/O Functions



This datasheet is provided as a guideline for selecting products.

Be sure to refer to the following manuals for application precautions and other information required for operation before attempting to use the product.

E5□C Digital Temperature Controllers User's Manual (Cat. No. H174)

E5□C Digital Temperature Controllers Communications Manual (Cat. No. H175)

## Model Number Legend and Standard Models

### Model Number Legend

E5CC-□□ □□□□-□□□□ (Example: E5CC-RX3A5M-000)

① ② ③ ④ ⑤ ⑥

| Model | ①                       | ②                        | ③                    | ④             | ⑤          | ⑥       | Meaning                          |                            |              |                                  |                 |           |  |
|-------|-------------------------|--------------------------|----------------------|---------------|------------|---------|----------------------------------|----------------------------|--------------|----------------------------------|-----------------|-----------|--|
|       | Control outputs 1 and 2 | No. of auxiliary outputs | Power supply voltage | Terminal type | Input type | Options |                                  |                            |              |                                  |                 |           |  |
| E5CC  |                         |                          |                      |               |            |         | 48 × 48 mm                       |                            |              |                                  |                 |           |  |
|       |                         |                          |                      |               |            |         | Control output 1                 |                            |              | Control output 2                 |                 |           |  |
|       | RX                      |                          |                      |               |            |         | Relay output                     |                            |              | None                             |                 |           |  |
|       | QX                      |                          |                      |               |            |         | Voltage output (for driving SSR) |                            |              | None                             |                 |           |  |
| *1 *3 | CX                      |                          |                      |               |            |         | Linear current output *2         |                            |              | None                             |                 |           |  |
|       | QQ                      |                          |                      |               |            |         | Voltage output (for driving SSR) |                            |              | Voltage output (for driving SSR) |                 |           |  |
|       | CQ                      |                          |                      |               |            |         | Linear current output *2         |                            |              | Voltage output (for driving SSR) |                 |           |  |
|       |                         | 3                        |                      |               |            |         | 3 (one common)                   |                            |              |                                  |                 |           |  |
|       |                         |                          | A                    |               |            |         | 100 to 240 VAC                   |                            |              |                                  |                 |           |  |
|       |                         |                          | D                    |               |            |         | 24 VAC/DC                        |                            |              |                                  |                 |           |  |
|       |                         |                          |                      | 5             |            |         | Screw terminals (with cover)     |                            |              |                                  |                 |           |  |
|       |                         |                          |                      |               | M          |         | Universal input                  |                            |              |                                  |                 |           |  |
|       |                         |                          |                      |               |            |         | HB alarm and HS alarm            | Communications             | Event inputs | Remote SP Input                  | Transfer output |           |  |
|       |                         |                          |                      |               |            | *1      | 000                              | ---                        | ---          | ---                              | ---             |           |  |
|       |                         |                          |                      |               |            |         | 001                              | 1                          | ---          | 2                                | ---             |           |  |
|       |                         |                          |                      |               |            | *1      | 003                              | 2<br>(for 3-phase heaters) | RS-485       | ---                              | ---             |           |  |
|       |                         |                          |                      |               |            | *3      | 004                              | ---                        | RS-485       | 2                                | ---             |           |  |
|       |                         |                          |                      |               |            |         | 005                              | ---                        | ---          | 4                                | ---             |           |  |
|       |                         |                          |                      |               |            |         | 006                              | ---                        | ---          | 2                                |                 | Provided. |  |
|       |                         |                          |                      |               |            |         | 007                              | ---                        | ---          | 2                                | Provided.       | ---       |  |

\*1. Options with HB and HS alarms (001 and 003) cannot be selected if a linear current output is selected for the control output.

\*2. The control output cannot be used as a transfer output.

\*3. Option 004 can be selected only when "CX" is selected for the control outputs.

## Heating and Cooling Control

### ● Using Heating and Cooling Control

#### ① Control Output Assignment

If there is no control output 2, an auxiliary output is used as the cooling control output.

If there is a control output 2, the two control outputs are used for heating and cooling.

(It does not matter which output is used for heating and which output is used for cooling.)

#### ② Control

If PID control is used, you can set PID control separately for heating and cooling.

This allows you to handle control systems with different heating and cooling response characteristics.

## Optional Products (Order Separately)

### USB-Serial Conversion Cable

| Model     |
|-----------|
| E58-CIFQ2 |

### Terminal Covers

| Model     |
|-----------|
| E53-COV17 |
| E53-COV23 |

**Note:** The E53-COV10 cannot be used.  
Refer to page 12 for the mounted dimensions.

### Waterproof Packing

| Model   |
|---------|
| Y92S-P8 |

**Note:** This Waterproof Packing is provided with the Digital Temperature Controller.

### Current Transformers (CTs)

| Hole diameter | Model   |
|---------------|---------|
| 5.8 mm        | E54-CT1 |
| 12.0 mm       | E54-CT3 |

### Adapter

| Model   |
|---------|
| Y92F-45 |

**Note:** Use this Adapter when the panel has already been prepared for an E5B□ Controller.

### Waterproof Cover

| Model    |
|----------|
| Y92A-48N |

### Mounting Adapter

| Model   |
|---------|
| Y92F-49 |

**Note:** This Mounting Adapter is provided with the Digital Temperature Controller.

### DIN Track Mounting Adapter

| Model   |
|---------|
| Y92F-52 |

### Front Covers

| Type             | Model    |
|------------------|----------|
| Hard Front Cover | Y92A-48H |
| Soft Front Cover | Y92A-48D |

### CX-Thermo Support Software

| Model       |
|-------------|
| EST2-2C-MV4 |

**Note:** CX-Thermo version 4.5 or higher is required for the E5CC.  
For the system requirements for the CX-Thermo, refer to information on the EST2-2C-MV4 on the OMRON website ([www.ia.omron.com](http://www.ia.omron.com)).

## Specifications

### Ratings

|                                      |  |  |
|--------------------------------------|--|--|
| <b>Power supply voltage</b>          | A in model number: 100 to 240 VAC, 50/60 Hz<br>D in model number: 24 VAC, 50/60 Hz; 24 VDC   |  |
| <b>Operating voltage range</b>       | 85% to 110% of rated supply voltage  |  |
| <b>Power consumption</b>             | Models with option selection of 000: 5.2 VA max. at 100 to 240 VAC, and 3.1 VA max. at 24 VAC or 1.6 W max. at 24 VDC<br>All other models: 6.5 VA max. at 100 to 240 VAC, and 4.1 VA max. at 24 VAC or 2.3 W max. at 24 VDC  |  |
| <b>Sensor input</b>                  | Temperature input<br>Thermocouple: K, J, T, E, L, U, N, R, S, B, W, or PL II<br>Platinum resistance thermometer: Pt100 or JPt100<br>Infrared temperature sensor (ES1B): 10 to 70°C, 60 to 120°C, 115 to 165°C, or 140 to 260°C<br>Analog input<br>Current input: 4 to 20 mA or 0 to 20 mA<br>Voltage input: 1 to 5 V, 0 to 5 V, or 0 to 10 V   |  |
| <b>Input impedance</b>               | Current input: 150 Ω max., Voltage input: 1 MΩ min.<br>(Use a 1:1 connection when connecting the ES2-HB/THB.)  |  |
| <b>Control method</b>                | ON/OFF control or 2-PID control (with auto-tuning)   |  |
| <b>Control output</b>                | <b>Relay output</b>  | SPST-NO, 250 VAC, 3 A (resistive load), electrical life: 100,000 operations, minimum applicable load: 5 V, 10 mA *   |
|                                      | <b>Voltage output (for driving SSR)</b>  | Output voltage: 12 VDC ±20% (PNP), max. load current: 21 mA, with short-circuit protection circuit   |
|                                      | <b>Linear current output</b>   | 4 to 20 mA DC/0 to 20 mA DC, load: 500 Ω max., resolution: approx. 10,000*   |
| <b>Auxiliary output</b>              | <b>Number of outputs</b>   | 3  |
|                                      | <b>Output specifications</b>   | SPST-NO relay outputs, 250 VAC, Models with 3 outputs: 2 A (resistive load), Electrical life: 100,000 operations, Minimum applicable load: 10 mA at 5 V                            |
| <b>Event input</b>                   | <b>Number of inputs</b>  | 2 or 4 (depends on model)  |
|                                      | <b>External contact input specifications</b>   | Contact input: ON: 1 kΩ max., OFF: 100 kΩ min.<br>Non-contact input: ON: Residual voltage: 1.5 V max., OFF: Leakage current: 0.1 mA max.<br>Current flow: Approx. 7 mA per contact |
| <b>Transfer output</b>               | <b>Number of outputs</b>   | 1 (only on models with a transfer output)  |
|                                      | <b>Output specifications</b>   | Contact output: 4 to 20 mA DC, load: 500 Ω max., resolution: approx. 10,000<br>Linear voltage output: 1 to 5 VDC, load: 1 kΩ max, resolution: Approx. 10,000                       |
| <b>Setting method</b>                | Digital setting using front panel keys   |  |
| <b>Remote SP input</b>               | Current input: 4 to 20 mA DC or 0 to 20 mA DC (input impedance: 150 Ω max.)<br>Voltage input: 1 to 5 V, 0 to 5 V, or 0 to 10 V (input impedance: 1 MΩ min.)  |  |
| <b>Indication method</b>             | 11-segment digital display and individual indicators<br>Character height: PV: 15.2 mm, SV: 7.1 mm  |  |
| <b>Multi SP</b>                      | Up to eight set points (SP0 to SP7) can be saved and selected using event inputs, key operations, or serial communications.  |  |
| <b>Bank switching</b>                | None   |  |
| <b>Other functions</b>               | Manual output, heating/cooling control, loop burnout alarm, SP ramp, other alarm functions, heater burnout (HB) alarm (including SSR failure (HS) alarm), 40% AT, 100% AT, MV limiter, input digital filter, self tuning, robust tuning, PV input shift, run/stop, protection functions, extraction of square root, MV change rate limit, simple calculations, temperature status display, simple programming, moving average of input value, and display brightness setting |  |
| <b>Ambient operating temperature</b> | -10 to 55°C (with no condensation or icing),<br>for 3-year warranty: -10 to 50°C (with no condensation or icing)   |  |
| <b>Ambient operating humidity</b>    | 25% to 85%   |  |
| <b>Storage temperature</b>           | -25 to 65°C (with no condensation or icing)  |  |

\* You cannot select a relay output or linear current output for control output 2.

## Input Ranges

### ● Thermocouple/Platinum Resistance Thermometer (Universal inputs)



Shaded settings are the default settings.

The applicable standards for the input types are as follows:

K, J, T, E, N, R, S, B: JIS C 1602-1995, IEC 60584-1

JPt100: JIS C 1604-1989, JIS C 1606-1989

L: Fe-CuNi, DIN 43710-1985

Pt100: JIS C 1604-1997, IEC 60751

U: Cu-CuNi, DIN 43710-1985

PL II: According to Platinel II electromotive force charts from BASF (previously Engelhard)

W: W5Re/W26Re, ASTM E988-1990

### ● Analog input

| Input type          | Current   |            | Voltage  |          |           |
|---------------------|---|------------|----------|----------|-----------|
| Input specification | 4 to 20 mA  | 0 to 20 mA | 1 to 5 V | 0 to 5 V | 0 to 10 V |
| Setting range       | Usable in the following ranges by scaling:<br>-1999 to 9999, -199.9 to 999.9,<br>-19.99 to 99.99 or -1.999 to 9.999 |            |          |          |           |
| Setting number      | 25  | 26         | 27       | 28       | 29        |

## Alarm Outputs

Each alarm can be independently set to one of the following 19 alarm types. The default is 2: Upper limit. (see note.)

Auxiliary outputs are allocated for alarms. ON delays and OFF delays (0 to 999 s) can also be specified.

**Note:** In the default settings for models with HB or HS alarms, alarm 1 is set to a heater alarm (HA) and the Alarm Type 1 parameter is not displayed.

To use alarm 1, set the output assignment to alarm 1.

| Set value   | Alarm type                                       | Alarm output operation                   |   | Description of function  |
|-------------|--|--|---|--|
|             |  | When alarm value X is positive           | When alarm value X is negative                    |  |
| 0           | Alarm function OFF                               | Output OFF                               |   | No alarm   |
| 1           | Upper- and lower-limit *1                        |  | *2  | Set the upward deviation in the set point for the alarm upper limit (H) and the lower deviation in the set point for the alarm lower limit (L). The alarm is ON when the PV is outside this deviation range. |
| 2 (default) | Upper-limit                                      |  |   | Set the upward deviation in the set point by setting the alarm value (X). The alarm is ON when the PV is higher than the SP by the deviation or more.  |
| 3           | Lower-limit                                      |  |   | Set the downward deviation in the set point by setting the alarm value (X). The alarm is ON when the PV is lower than the SP by the deviation or more.   |
| 4           | Upper- and lower-limit range *1                  |  | *3  | Set the upward deviation in the set point for the alarm upper limit (H) and the lower deviation in the set point for the alarm lower limit (L). The alarm is ON when the PV is inside this deviation range.  |
| 5           | Upper- and lower-limit with standby sequence *1  |  | *4  | A standby sequence is added to the upper- and lower-limit alarm (1). *6  |
| 6           | Upper-limit with standby sequence                |  |   | A standby sequence is added to the upper-limit alarm (2). *6   |
| 7           | Lower-limit with standby sequence                |  |   | A standby sequence is added to the lower-limit alarm (3). *6   |
| 8           | Absolute-value upper-limit                       |  |   | The alarm will turn ON if the process value is larger than the alarm value (X) regardless of the set point.  |
| 9           | Absolute-value lower-limit                       |  |   | The alarm will turn ON if the process value is smaller than the alarm value (X) regardless of the set point.   |
| 10          | Absolute-value upper-limit with standby sequence |  |   | A standby sequence is added to the absolute-value upper-limit alarm (8). *6  |
| 11          | Absolute-value lower-limit with standby sequence |  |   | A standby sequence is added to the absolute-value lower-limit alarm (9). *6  |
| 12          | LBA (alarm 1 type only)                          | -  |   | *7   |
| 13          | PV change rate alarm                             | -  |   | *8   |
| 14          | SP absolute-value upper-limit alarm              |  |   | This alarm type turns ON the alarm when the set point (SP) is higher than the alarm value (X).   |
| 15          | SP absolute-value lower-limit alarm              |  |   | This alarm type turns ON the alarm when the set point (SP) is lower than the alarm value (X).  |
| 16          | MV absolute-value upper-limit alarm *9           | Standard Control<br>                     | Standard Control<br>                              | This alarm type turns ON the alarm when the manipulated variable (MV) is higher than the alarm value (X).  |
|             |  | Heating/Cooling Control (Heating MV)<br> | Heating/Cooling Control (Heating MV)<br>Always ON |  |
| 17          | MV absolute-value lower-limit alarm *9           | Standard Control<br>                     | Standard Control<br>                              | This alarm type turns ON the alarm when the manipulated variable (MV) is lower than the alarm value (X).   |
|             |  | Heating/Cooling Control (Cooling MV)<br> | Heating/Cooling Control (Cooling MV)<br>Always ON |  |
| 18          | RSP absolute-value upper-limit alarm *10         |  |   | This alarm type turns ON the alarm when the remote SP (RSP) is higher than the alarm value (X).  |
| 19          | RSP absolute-value lower-limit alarm *10         |  |   | This alarm type turns ON the alarm when the remote SP (RSP) is lower than the alarm value (X).   |

\*1 With set values 1, 4 and 5, the upper and lower limit values can be set independently for each alarm type, and are expressed as "L" and "H."

\*2 Set value: 1, Upper- and lower-limit alarm



\*3 Set value: 4, Upper- and lower-limit range



\*4 Set value: 5, Upper- and lower-limit with standby sequence For Upper- and Lower-Limit Alarm Described Above \*2

- Case 1 and 2

- Always OFF when the upper-limit and lower-limit hysteresis overlaps.

- Case 3: Always OFF

\*5 Set value: 5, Upper- and lower-limit with standby sequence

- Always OFF when the upper-limit and lower-limit hysteresis overlaps.

\*6 Refer to the *E5CC Digital Temperature Controllers User's Manual* (Cat. No. H174) for information on the operation of the standby sequence.

\*7 Refer to the *E5CC Digital Temperature Controllers User's Manual* (Cat. No. H174) for information on the loop burnout alarm (LBA).

\*8 Refer to the *E5CC Digital Temperature Controllers User's Manual* (Cat. No. H174) for information on the PV change rate alarm.

\*9 When heating/cooling control is performed, the MV absolute upper limit alarm functions only for the heating operation and the MV absolute lower limit alarm functions only for the cooling operation.

\*10 This value is displayed only when a remote SP input is used. It functions in both Local SP Mode and Remote SP Mode.



## Characteristics

|   |   |  |
|---|---|--|
| <b>Indication accuracy<br/>(at the ambient temperature of 23°C)</b> | Thermocouple: (±0.3% of PV or ±1°C, whichever is greater) ±1 digit max. *1<br>Platinum resistance thermometer: (±0.2% of PV or ±0.8°C, whichever is greater) ±1 digit<br>Analog input: ±0.2% FS ±1 digit max.<br>CT input: ±5% FS ±1 digit max.   |  |
| <b>Transfer output accuracy</b>                                     | ±0.3% FS max.   |  |
| <b>Remote SP Input Type</b>   | ±0.2% FS ±1 digit max.  |  |
| <b>Influence of temperature *2</b>                                  | Thermocouple input (R, S, B, W, PL II): (±1% of PV or ±10°C, whichever is greater) ±1 digit max.<br>Other thermocouple input: (±1% of PV or ±4°C, whichever is greater) ±1 digit max. *3<br>Platinum resistance thermometer: (±1% of PV or ±2°C, whichever is greater) ±1 digit max.  |  |
| <b>Influence of voltage *2</b>                                      | Analog input: ±1%FS ±1 digit max.<br>CT input: ±5% FS ±1 digit max.<br>Remote SP input: ±1% FS ±1 digit max.  |  |
| <b>Input sampling period</b>  | 50 ms   |  |
| <b>Hysteresis</b>   | Temperature input: 0.1 to 999.9°C or °F (in units of 0.1°C or °F)<br>Analog input: 0.01% to 99.99% FS (in units of 0.01% FS)  |  |
| <b>Proportional band (P)</b>  | Temperature input: 0.1 to 999.9°C or °F (in units of 0.1°C or °F)<br>Analog input: 0.1% to 999.9% FS (in units of 0.1% FS)  |  |
| <b>Integral time (I)</b>  | 0 to 9999 s (in units of 1 s), 0.0 to 999.9 s (in units of 0.1 s) *4  |  |
| <b>Derivative time (D)</b>  | 0 to 9999 s (in units of 1 s), 0.0 to 999.9 s (in units of 0.1 s) *4  |  |
| <b>Proportional band (P) for cooling</b>                            | Temperature input: 0.1 to 999.9°C or °F (in units of 0.1°C or °F)<br>Analog input: 0.1% to 999.9% FS (in units of 0.1% FS)  |  |
| <b>Integral time (I) for cooling</b>                                | 0 to 9999 s (in units of 1 s), 0.0 to 999.9 s (in units of 0.1 s) *4  |  |
| <b>Derivative time (D) for cooling</b>                              | 0 to 9999 s (in units of 1 s), 0.0 to 999.9 s (in units of 0.1 s) *4  |  |
| <b>Control period</b>   | 0.1, 0.2, 0.5, 1 to 99 s (in units of 1 s)  |  |
| <b>Manual reset value</b>   | 0.0 to 100.0% (in units of 0.1%)  |  |
| <b>Alarm setting range</b>  | -1999 to 9999 (decimal point position depends on input type)  |  |
| <b>Influence of signal source resistance</b>                        | Thermocouple: 0.1°C/Ω max. (100 Ω max.)<br>Platinum resistance thermometer: 0.1°C/Ω max. (10 Ω max.)  |  |
| <b>Insulation resistance</b>  | 20 MΩ min. (at 500 VDC)   |  |
| <b>Dielectric strength</b>  | 2,300 VAC, 50/60 Hz for 1 min between terminals of different charge   |  |
| <b>Vibration</b>  | <b>Malfunction</b>  | 10 to 55 Hz, 20 m/s <sup>2</sup> for 10 min each in X, Y, and Z directions   |
|   | <b>Resistance</b>   | 10 to 55 Hz, 20 m/s <sup>2</sup> for 2 hrs each in X, Y, and Z directions  |
| <b>Shock</b>  | <b>Malfunction</b>  | 100 m/s <sup>2</sup> , 3 times each in X, Y, and Z directions  |
|   | <b>Resistance</b>   | 300 m/s <sup>2</sup> , 3 times each in X, Y, and Z directions  |
| <b>Weight</b>   | Controller: Approx. 120 g, Mounting Bracket: Approx. 10 g   |  |
| <b>Degree of protection</b>   | Front panel: IP66, Rear case: IP20, Terminals: IP00   |  |
| <b>Memory protection</b>  | Non-volatile memory (number of writes: 1,000,000 times)   |  |
| <b>Setup Tool</b>   | CX-Thermo version 4.5 or higher   |  |
| <b>Setup Tool port</b>  | E5CC top panel: An E58-CIFQ2 USB-Serial Conversion Cable is used to connect to a USB port on the computer. *5   |  |
| <b>Standards</b>  | <b>Approved standards</b>   | UL 61010-1, CSA C22.2 No. 611010-1 (evaluated by UL), KOSHA certified (some models) *6, Korean Radio Waves Act (Act 10564) |
|   | <b>Conformed standards</b>  | EN 61010-1 (IEC 61010-1): Pollution level 2, overcurrent category II, Lloyd's standards *7                                 |
| <b>EMC</b>  | EMI: EN61326<br>Radiated Interference Electromagnetic Field Strength: EN 55011 Group 1, class A<br>Noise Terminal Voltage: EN 55011 Group 1, class A<br>EMS: EN 61326<br>ESD Immunity: EN 61000-4-2<br>Electromagnetic Field Immunity: EN 61000-4-3<br>Burst Noise Immunity: EN 61000-4-4<br>Conducted Disturbance Immunity: EN 61000-4-6<br>Surge Immunity: EN 61000-4-5<br>Voltage Dip/Interrupting Immunity: EN 61000-4-11 |  |

\*1 The indication accuracy of K thermocouples in the -200 to 1300°C range, T and N thermocouples at a temperature of -100°C max., and U and L thermocouples at any temperatures is ±2°C ±1 digit max. The indication accuracy of the B thermocouple at a temperature of 400°C max. is not specified. The indication accuracy of B thermocouples at a temperature of 400 to 800°C is ±3°C max. The indication accuracy of the R and S thermocouples at a temperature of 200°C max. is ±3°C ±1 digit max. The indication accuracy of W thermocouples is (±0.3% of PV or ±3°C, whichever is greater) ±1 digit max. The indication accuracy of PL II thermocouples is ±0.3% of PV or ±2°C, whichever is greater, ±1 digit max.

\*2 Ambient temperature: -10°C to 23°C to 55°C, Voltage range: -15% to 10% of rated voltage

\*3 K thermocouple at -100°C max.: ±10°C max.

\*4 The unit is determined by the setting of the Integral/Derivative Time Unit parameter.

\*5 External communications (RS-485) and USB-serial conversion cable communications can be used at the same time.

\*6 Access the following website for information on certified models. <http://www.ia.omron.com/support/models/index.html>

\*7 Refer to information on maritime standards in *Shipping Standards* on page 52 for compliance with Lloyd's Standards.

## USB-Serial Conversion Cable

|                                      |   |
|--------------------------------------|---|
| <b>Applicable OS</b>                 | Windows 2000, XP, Vista, or 7   |
| <b>Applicable software</b>           | CX-Thermo version 4.5 or higher   |
| <b>Applicable models</b>             | E5□C Series and E5CB Series   |
| <b>USB interface standard</b>        | Conforms to USB Specification 2.0.  |
| <b>DTE speed</b>                     | 38400 bps   |
| <b>Connector specifications</b>      | Computer: USB (type A plug)<br>Digital Temperature Controller: Special serial connector           |
| <b>Power supply</b>                  | Bus power (Supplied from USB host controller.)*   |
| <b>Power supply voltage</b>          | 5 VDC   |
| <b>Current consumption</b>           | 450 mA max.   |
| <b>Output voltage</b>                | 4.7±0.2 VDC<br>(Supplied from USB-Serial Conversion Cable to the Digital Temperature Controller.) |
| <b>Output current</b>                | 250 mA max.<br>(Supplied from USB-Serial Conversion Cable to the Digital Temperature Controller.) |
| <b>Ambient operating temperature</b> | 0 to 55°C (with no condensation or icing)   |
| <b>Ambient operating humidity</b>    | 10% to 80%  |
| <b>Storage temperature</b>           | -20 to 60°C (with no condensation or icing)   |
| <b>Storage humidity</b>              | 10% to 80%  |
| <b>Altitude</b>                      | 2,000 m max.  |
| <b>Weight</b>                        | Approx. 120 g   |

Windows is a registered trademark of Microsoft Corporation in the United States and/or other countries.

\* Use a high-power port for the USB port.

**Note:** A driver must be installed on the computer. Refer to the *Instruction Manual* included with the Cable for the installation procedure.

## Communications Specifications

|  |   |
|--|---|
| <b>Transmission line connection method</b> | RS-485: Multidrop   |
| <b>Communications</b>                      | RS-485 (two-wire, half duplex)  |
| <b>Synchronization method</b>              | Start-stop synchronization  |
| <b>Protocol</b>                            | CompoWay/F, or Modbus   |
| <b>Baud rate</b>                           | 19200, 38400, or 57600 bps  |
| <b>Transmission code</b>                   | ASCII   |
| <b>Data bit length*</b>                    | 7 or 8 bits   |
| <b>Stop bit length*</b>                    | 1 or 2 bits   |
| <b>Error detection</b>                     | Vertical parity (none, even, odd)<br>Block check character (BCC) with CompoWay/F or CRC-16 Modbus |
| <b>Flow control</b>                        | None  |
| <b>Interface</b>                           | RS-485  |
| <b>Retry function</b>                      | None  |
| <b>Communications buffer</b>               | 217 bytes   |
| <b>Communications response wait time</b>   | 0 to 99 ms<br>Default: 20 ms  |

\* The baud rate, data bit length, stop bit length, and vertical parity can be individually set using the Communications Setting Level.

## Communications Functions

|                                    |  |
|------------------------------------|--|
| <b>Programless communications*</b> | You can use the memory in the PLC to read and write E5□C parameters, start and stop operation, etc. The E5□C automatically performs communications with PLCs. No communications programming is required.<br>Number of connected Temperature Controllers: 32 max.<br>Applicable PLCs<br>OMRON PLCs<br>SYMAC CS Series, CJ Series, or CP Series<br>Mitsubishi Electric PLCs<br>MELSEC Q Series or L Series |
|------------------------------------|--|

|   |   |
|---|---|
| <b>Communications between components*</b> | When Digital Temperature Controllers are connected, the parameters can be copied from the Digital Temperature Controller that is set as the master to the Digital Temperature Controllers that are set as slaves.<br>Number of connected Digital Temperature Controllers: 32 max. (including master)<br>When Digital Temperature Controllers are connected, set points and RUN/STOP commands can be sent from the Digital Temperature Controller that is set as the master to the Digital Temperature Controllers that are set as slaves.<br>Slope and offsets can be set for the set point.<br>Number of connected Digital Temperature Controllers: 32 max. (including master) |
|---|---|

MELSEC is a registered trademark of Mitsubishi Electric Corporation.

\* A Temperature Controller with version 1.1 or higher is required.

## Current Transformer (Order Separately) Ratings

|                                   |   |
|-----------------------------------|---|
| <b>Dielectric strength</b>        | 1,000 VAC for 1 min                               |
| <b>Vibration resistance</b>       | 50 Hz, 98 m/s <sup>2</sup>                        |
| <b>Weight</b>                     | E54-CT1: Approx. 11.5 g,<br>E54-CT3: Approx. 50 g |
| <b>Accessories (E54-CT3 only)</b> | Armatures (2)<br>Plugs (2)                        |

## Heater Burnout Alarms and SSR Failure Alarms

|  |  |
|--|--|
| <b>CT input (for heater current detection)</b> | Models with detection for singlephase heaters: One input<br>Models with detection for singlephase or three-phase heaters: Two inputs |
| <b>Maximum heater current</b>                  | 50 A AC  |
| <b>Input current indication accuracy</b>       | ±5% FS ±1 digit max.   |
| <b>Heater burnout alarm setting range *1</b>   | 0.1 to 49.9 A (in units of 0.1 A)<br>Minimum detection ON time: 100 ms *3  |
| <b>SSR failure alarm setting range *2</b>      | 0.1 to 49.9 A (in units of 0.1 A)<br>Minimum detection OFF time: 100 ms *4   |

\*1 For heater burnout alarms, the heater current will be measured when the control output is ON, and the output will turn ON if the heater current is lower than the set value (i.e., heater burnout detection current value).

\*2 For SSR failure alarms, the heater current will be measured when the control output is OFF, and the output will turn ON if the heater current is higher than the set value (i.e., SSR failure detection current value).

\*3 The value is 30 ms for a control period of 0.1 s or 0.2 s.

\*4 The value is 35 ms for a control period of 0.1 s or 0.2 s.

## Electrical Life Expectancy Curve for Relays (Reference Values)



# External Connections

## E5CC



- Note:** 1. The application of the terminals depends on the model.
- 2. Do not wire the terminals that are shown with a gray background.
- 3. When complying with EMC standards, the cable that connects the sensor must be 30 m or less. If the cable length exceeds 30 m, compliance with EMC standards will not be possible.
- 4. Connect M3 crimped terminals.

## Isolation/Insulation Block Diagrams

### Models with 3 Auxiliary Outputs



- ◻ : Reinforced insulation
- ◻ : Functional isolation

**Note:** Auxiliary outputs 1 to 3 are not insulated.

# E5CC

## Nomenclature

### E5CC

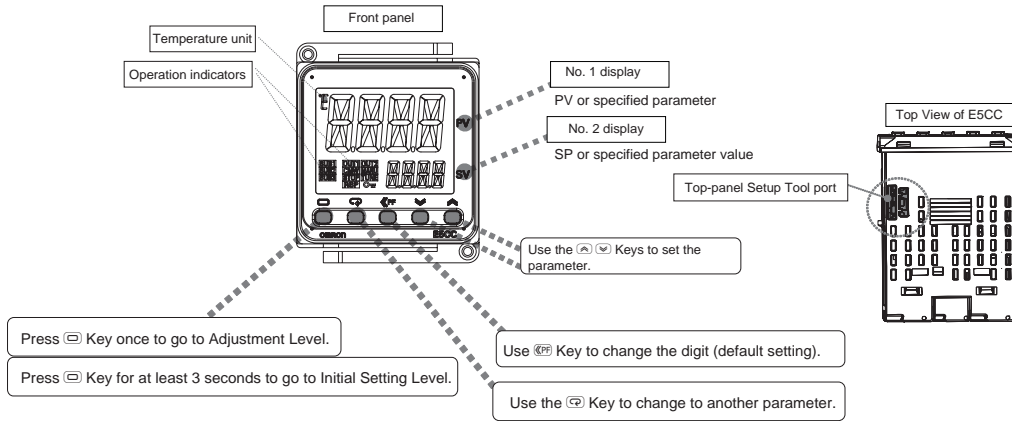

## Dimensions

(Unit: mm)

## Controllers

### E5CC



### Panel Cutout



The Setup Tool port is on the top of the Temperature Controller. It is used to connect the Temperature Controller to the computer to use the Setup Tool. The E58-CIFQ2 USB-Serial Conversion Cable is required to make the connection. Refer to the instructions that are provided with the USB-Serial Conversion Cable for the connection procedure.

**Note:** Do not leave the USB-Serial Conversion Cable connected when you use the Temperature Controller.

- Recommended panel thickness is 1 to 5 mm.
- Group mounting is not possible in the vertical direction. (Maintain the specified mounting space between Controllers.)
- To mount the Controller so that it is waterproof, insert the waterproof packing onto the Controller.
- When two or more Controllers are mounted, make sure that the surrounding temperature does not exceed the allowable operating temperature specified in the specifications.
- To attach the USB-Serial Conversion Cable to the control panel, use a panel thickness of 1 to 2.5 mm.

## Accessories (Order Separately)

### ● USB-Serial Conversion Cable E58-CIFQ2

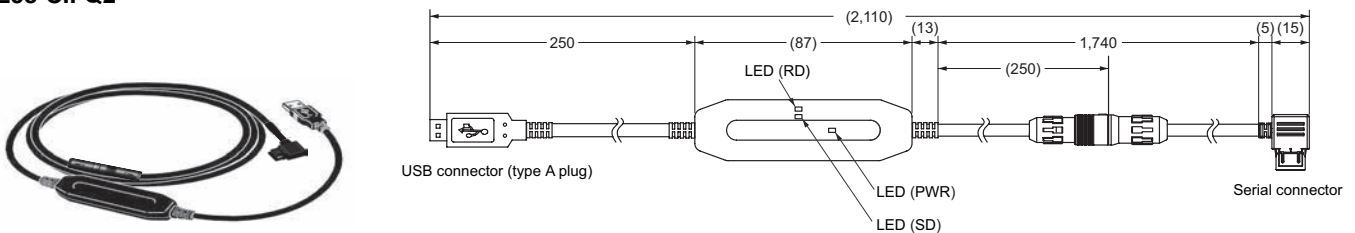

### ● Terminal Covers E53-COV17

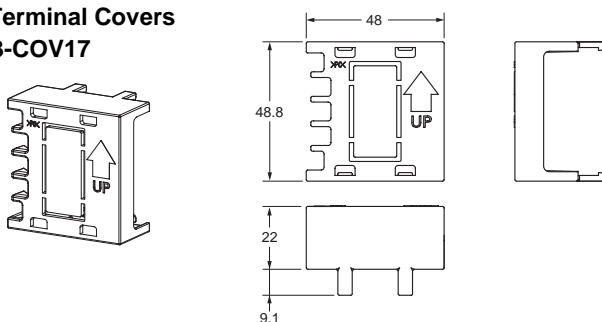

### ● Terminal Covers E53-COV23 (Three Covers provided.)

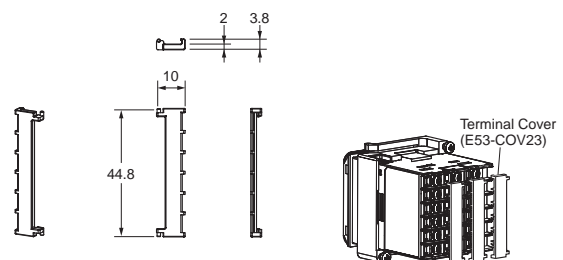

● **Waterproof Packing**  
**Y92S-P8 (for DIN 48 × 48)**



The Waterproof Packing is provided with the Temperature Controller.  
 Order the Waterproof Packing separately if it becomes lost or damaged.  
 The Waterproof Packing can be used to achieve an IP66 degree of protection.  
 (Deterioration, shrinking, or hardening of the waterproof packing may occur depending on the operating environment. Therefore, periodic replacement is recommended to ensure the level of waterproofing specified in IP66. The time for periodic replacement depends on the operating environment. Be sure to confirm this point at your site.  
 Consider three years a rough standard.)  
 The Waterproof Packing does not need to be attached if a waterproof structure is not required.

● **Current Transformers**

**E54-CT1**



**Thru-current (Io) vs. Output Voltage (Eo)**  
**(Reference Values)**

**E54-CT1**

Maximum continuous heater current: 50 A (50/60 Hz)  
 Number of windings: 400±2  
 Winding resistance: 18±2 Ω



**E54-CT3**



**Thru-current (Io) vs. Output Voltage (Eo)**  
**(Reference Values)**

**E54-CT3**

Maximum continuous heater current: 120 A (50/60 Hz)  
 (Maximum continuous heater current for an OMRON Digital Temperature Controller is 50 A.)  
 Number of windings: 400±2  
 Winding resistance: 8±0.8 Ω



**E54-CT3 Accessories**

● **Armature**



● **Plug**



**Connection Example**



# E5CC

## ● Adapter

### Y92F-45

- Note:** 1. Use this Adapter when the Front Panel has already been prepared for the E5B□.  
 2. Only black is available.  
 3. You cannot use the E58-CIFQ2 USB-Serial Conversion Cable if you use the Y92F-45 Adapter. To use the USB-Serial Conversion Cable to make the settings, do so before you mount the Temperature Controller in the panel.



### Mounted to E5CC



## ● DIN Track Mounting Adapter

### Y92F-52

- Note:** This Adapter cannot be used together with the Terminal Cover.  
 Remove the Terminal Cover to use the Adapter.



This Adapter is used to mount the E5CC to a DIN Track. If you use the Adapter, there is no need for a plate to mount in the panel or to drill mounting holes in the panel.

### Mounted to E5CC



### ● Watertight Cover

Y92A-48N



### ● Mounting Adapter

Y92F-49



The Mounting Adapter is provided with the Temperature Controller. Order this Adapter separately if it becomes lost or damaged.

### ● Protective Cover

Y92A-48D

**Note:** This Protective Cover cannot be used if the Waterproof Packing is installed.



This Protective Cover is soft type. It is able to operate the controller with using this cover.

### ● Protective Cover

Y92A-48H



This Protective Cover is hard type. Please use it for the mis-operation prevention etc.

# Digital Temperature Controller

# E5EC/E5AC (48 × 96 mm/96 × 96 mm)

**Large White PV Display That's Easier to Read.  
Easy to Use, from Model Selection to  
Setup and Operation.  
A Complete Range of I/O Capacities,  
Functions, and Performance.  
Handles More Applications.**

- A white LCD PV display with a height of approx. 18 mm for the E5EC and 25 mm for the E5AC improves visibility.
- Tool ports are provided both on the top panel and the front panel. Set up the Controller without wiring the power supply by connecting to the computer with a Communications Conversion Cable (sold separately). Setup is easy with the CX-Thermo (sold separately).
- High-speed sampling at 50 ms.
- Models are available with up to 4 auxiliary outputs, up to 6 event inputs, a transfer output, and a remote SP input to cover a wide range of applications.
- Short body with depth of only 60 mm.
- Easy connections to a PLC with programless communications. Use component communications to link Temperature Controllers to each other.
- The new position-proportional control models allow you to control valves as well.



48 × 96 mm  
E5EC

96 × 96 mm  
E5AC

Refer to your OMRON website for the most recent information on applicable safety standards.

Refer to Safety Precautions on page 50.

## Main I/O Functions



This datasheet is provided as a guideline for selecting products.

Be sure to refer to the following manuals for application precautions and other information required for operation before attempting to use the product.

E5□C Digital Temperature Controllers User's Manual (Cat. No. H174)

E5□C Digital Temperature Controllers Communications Manual (Cat. No. H175)



## Model Number Legend and Standard Models

### Model Number Legend

E5EC-□□ □ □ □ □ -□□□□ (Example: E5EC-RX4A5M-000)

① ② ③ ④ ⑤ ⑥

E5AC-□□ □ □ □ □ -□□□□ (Example: E5AC-RX4A5M-000)

① ② ③ ④ ⑤ ⑥

| Model                          | ①                              |              | ②                        | ③                    | ④             | ⑤          | ⑥       | Meaning   |                                    |                     |                        |                        |
|--------------------------------|--------------------------------|--------------|--------------------------|----------------------|---------------|------------|---------|---|------------------------------------|---------------------|------------------------|------------------------|
|                                | Control outputs 1 and 2        |              | No. of auxiliary outputs | Power supply voltage | Terminal type | Input type | Options |   |                                    |                     |                        |                        |
| E5EC                           |                                |              |                          |                      |               |            |         | 48 × 96 mm  |                                    |                     |                        |                        |
| E5AC                           |                                |              |                          |                      |               |            |         | 96 × 96 mm  |                                    |                     |                        |                        |
|                                |                                |              |                          |                      |               |            |         | <b>Control output 1</b>   | <b>Control output 2</b>            |                     |                        |                        |
|                                | RX                             |              |                          |                      |               |            |         | Relay output  | None                               |                     |                        |                        |
|                                | QX                             |              |                          |                      |               |            |         | Voltage output (for driving SSR)  | None                               |                     |                        |                        |
| *2                             | CX                             |              |                          |                      |               |            |         | Linear current output   | None                               |                     |                        |                        |
|                                | QQ                             |              |                          |                      |               |            |         | Voltage output (for driving SSR)  | Voltage output (for driving SSR)   |                     |                        |                        |
|                                | QR                             |              |                          |                      |               |            |         | Voltage output (for driving SSR)  | Relay output                       |                     |                        |                        |
|                                | RR                             |              |                          |                      |               |            |         | Relay output  | Relay output                       |                     |                        |                        |
| *2                             | CC                             |              |                          |                      |               |            |         | Linear current output   | Linear current output              |                     |                        |                        |
| *2                             | CQ                             |              |                          |                      |               |            |         | Linear current output   | Voltage output (for driving SSR)   |                     |                        |                        |
|                                | PR                             |              |                          |                      |               |            |         | Position-proportional relay output  | Position-proportional relay output |                     |                        |                        |
|                                |                                |              | *3 4                     |                      |               |            |         | 4 (auxiliary outputs 1 and 2 with same common and auxiliary outputs 3 and 4 with same common) |                                    |                     |                        |                        |
|                                |                                |              |                          | A                    |               |            |         | 100 to 240 VAC  |                                    |                     |                        |                        |
|                                |                                |              |                          | D                    |               |            |         | 24 VAC/DC   |                                    |                     |                        |                        |
|                                | <b>Control outputs 1 and 2</b> |              |                          |                      | 5             |            |         | Screw terminals (with cover)  |                                    |                     |                        |                        |
|                                |                                |              |                          |                      |               | M          |         | Universal input   |                                    |                     |                        |                        |
| Option selection conditions *1 | For RX, QX, QQ, QR, RR, or CQ  | For CX or CC | For PR                   |                      |               |            |         | <b>HB alarm and HS alarm</b>  | <b>Communications</b>              | <b>Event inputs</b> | <b>Remote SP Input</b> | <b>Transfer output</b> |
|                                | Selectable                     | Selectable   | Selectable               |                      |               |            | 000     | ---   | ---                                | ---                 | ---                    | ---                    |
|                                |                                | Selectable   | Selectable               |                      |               |            | 004     | ---   | RS-485                             | 2                   | ---                    | ---                    |
|                                |                                | Selectable   |                          |                      |               |            | 005     | ---   | ---                                | 4                   | ---                    | ---                    |
|                                | Selectable                     |              |                          |                      |               |            | 009     | 2 (for 3-phase heaters)   | RS-485                             | 2                   | ---                    | ---                    |
|                                | Selectable                     |              |                          |                      |               |            | 010     | 1   | ---                                | 4                   | ---                    | ---                    |
|                                | Selectable                     |              |                          |                      |               |            | 011     | 1   | ---                                | 6                   | Provided.              | Provided.              |
|                                |                                | Selectable   |                          |                      |               |            | 013     | ---   | ---                                | 6                   | Provided.              | Provided.              |
|                                | Selectable                     | Selectable   |                          |                      |               | 014        | ---     | RS-485  | 4                                  | Provided.           | Provided.              |                        |

\*1. The options that can be selected depend on the type of control output.

\*2. The control output cannot be used as a transfer output.

\*3. A model with four auxiliary outputs must be selected.

## Heating and Cooling Control

### I Using Heating and Cooling Control

#### ① Control Output Assignment

If there is no control output 2, an auxiliary output is used as the cooling control output.

If there is a control output 2, the two control outputs are used for heating and cooling.

(It does not matter which output is used for heating and which output is used for cooling.)

#### ② Control

If PID control is used, you can set PID control separately for heating and cooling.

This allows you to handle control systems with different heating and cooling response characteristics.

## Optional Products (Order Separately)

### USB-Serial Conversion Cable

| Model     |
|-----------|
| E58-CIFQ2 |

### Communications Conversion Cable

| Model       |
|-------------|
| E58-CIFQ2-E |

**Note:** Always use this product together with the E58-CIFQ2. This Cable is used to connect to the front-panel Setup Tool port.

### Terminal Covers

| Model     |
|-----------|
| E53-COV24 |

### Waterproof Packing

| Applicable Controller | Model    |
|-----------------------|----------|
| E5EC                  | Y92S-P9  |
| E5AC                  | Y92S-P10 |

**Note:** This Waterproof Packing is provided with the Digital Temperature Controller.

### Waterproof Cover

| Applicable Controller | Model    |
|-----------------------|----------|
| E5EC                  | Y92A-49N |
| E5AC                  | Y92A-96N |

### Front Port Cover

| Model   |
|---------|
| Y92S-P7 |

**Note:** This Front Port Cover is provided with the Digital Temperature Controller.

### Mounting Adapter

| Model   |
|---------|
| Y92F-51 |

**Note:** This Mounting Adapter is provided with the Digital Temperature Controller.

### Current Transformers (CTs)

| Hole diameter | Model   |
|---------------|---------|
| 5.8 mm        | E54-CT1 |
| 12.0 mm       | E54-CT3 |

### CX-Thermo Support Software

| Model       |
|-------------|
| EST2-2C-MV4 |

**Note:** CX-Thermo version 4.5 or higher is required for the E5EC. For the system requirements for the CX-Thermo, refer to information on the EST2-2C-MV4 on the OMRON website ([www.ia.omron.com](http://www.ia.omron.com)).

## Specifications

### Ratings

|                                      |  |  |
|--------------------------------------|--|--|
| <b>Power supply voltage</b>          |  | A in model number: 100 to 240 VAC, 50/60 Hz<br>D in model number: 24 VAC, 50/60 Hz; 24 VDC   |
| <b>Operating voltage range</b>       |  | 85% to 110% of rated supply voltage  |
| <b>Power consumption</b>             | <b>E5EC</b>                                  | Models with option selection of 000:6.6 VA max. at 100 to 240 VAC, and 4.1 VA max. at 24 VAC or 2.3 W max. at 24 VDC<br>All other models: 8.3 VA max. at 100 to 240 VAC, and 5.5 VA max. at 24 VAC or 3.2 W max. at 24 VDC   |
|                                      | <b>E5AC</b>                                  | Models with option selection of 000:7.0 VA max. at 100 to 240 VAC, and 4.2 VA max. at 24 VAC or 2.4 W max. at 24 VDC<br>All other models: 9.0 VA max. at 100 to 240 VAC, and 5.6 VA max. at 24 VAC or 3.4 W max. at 24 VDC   |
| <b>Sensor input</b>                  |  | Temperature input<br>Thermocouple: K, J, T, E, L, U, N, R, S, B, W, or PL II<br>Platinum resistance thermometer: Pt100 or JPt100<br>Infrared temperature sensor (ES1B): 10 to 70°C, 60 to 120°C, 115 to 165°C, or 140 to 260°C<br>Analog input<br>Current input: 4 to 20 mA or 0 to 20 mA<br>Voltage input: 1 to 5 V, 0 to 5 V, or 0 to 10 V   |
| <b>Input impedance</b>               |  | Current input: 150 Ω max., Voltage input: 1 MΩ min.<br>(Use a 1:1 connection when connecting the ES2-HB/THB.)  |
| <b>Control method</b>                |  | ON/OFF or 2-PID control (with autotuning)  |
| <b>Control output</b>                | <b>Relay output</b>                          | SPST-NO, 250 VAC, 5 A (resistive load), electrical life: 100,000 operations, minimum applicable load: 5 V, 10 mA   |
|                                      | <b>Voltage output (for driving SSR)</b>      | Output voltage: 12 VDC ±20% (PNP), max. load current: 40 mA, with short-circuit protection circuit (The maximum load current is 21 mA for models with two control outputs.)  |
|                                      | <b>Linear current output</b>                 | 4 to 20 mA DC/0 to 20 mA DC, load: 500 Ω max., resolution: approx. 10,000  |
| <b>Auxiliary output</b>              | <b>Number of outputs</b>                     | 4  |
|                                      | <b>Output specifications</b>                 | SPST-NO. relay outputs, 250 VAC, Models with 4 outputs: 2 A (resistive load), Electrical life: 100,000 operations, Minimum applicable load: 10 mA at 5 V   |
| <b>Event input</b>                   | <b>Number of inputs</b>                      | 2, 4 or 6 (depends on model)   |
|                                      | <b>External contact input specifications</b> | Contact input: ON: 1 kΩ max., OFF: 100 kΩ min.   |
|                                      |  | Non-contact input: ON: Residual voltage: 1.5 V max., OFF: Leakage current: 0.1 mA max.<br>Current flow: Approx. 7 mA per contact   |
| <b>Transfer output</b>               | <b>Number of outputs</b>                     | 1 (only on models with a transfer output)  |
|                                      | <b>Output specifications</b>                 | Current output: 4 to 20 mA DC, Load: 500 Ω max., Resolution: Approx. 10,000<br>Linear voltage output: 1 to 5 VDC, load: 1 kΩ max, Resolution: Approx. 10,000   |
| <b>Remote SP input</b>               |  | Current input: 4 to 20 mA DC or 0 to 20 mA DC (input impedance: 150 Ω max.)<br>Voltage input: 1 to 5 V, 0 to 5 V, or 0 to 10 V (input impedance: 1 MΩ min.)  |
| <b>Potentiometer input</b>           |  | 100 Ω to 10 kΩ   |
| <b>Setting method</b>                |  | Digital setting using front panel keys   |
| <b>Indication method</b>             |  | 11-segment digital display and individual indicators<br>Character height: E5EC: PV: 18.0 mm, SV: 11.0 mm, MV: 7.8 mm<br>E5AC: PV: 25.0 mm, SV: 15.0 mm, MV: 9.5 mm<br>Three displays Contents: PV/SV/MV, PV/SV/Multi-SP, or PV/SV/Remaining soak time<br>Numbers of digits: 4 digits each for PM, SV, and MV displays  |
| <b>Multi SP</b>                      |  | Up to eight set points (SP0 to SP7) can be saved and selected using event inputs, key operations, or serial communications.  |
| <b>Bank switching</b>                |  | None   |
| <b>Other functions</b>               |  | Manual output, heating/cooling control, loop burnout alarm, SP ramp, other alarm functions, heater burnout (HB) alarm (including SSR failure (HS) alarm), 40% AT, 100% AT, MV limiter, input digital filter, self tuning, robust tuning, PV input shift, run/stop, protection functions, extraction of square root, MV change rate limit, simple calculations, temperature status display, simple programming, moving average of input value, and display brightness setting |
| <b>Ambient operating temperature</b> |  | -10 to 55°C (with no condensation or icing),<br>for 3-year warranty: -10 to 50°C (with no condensation or icing)   |
| <b>Ambient operating humidity</b>    |  | 25% to 85%   |
| <b>Storage temperature</b>           |  | -25 to 65°C (with no condensation or icing)  |

## Input Ranges

### ● Thermocouple/Platinum Resistance Thermometer (Universal inputs)



Shaded settings are the default settings.

The applicable standards for the input types are as follows:

K, J, T, E, N, R, S, B: JIS C 1602-1995, IEC 60584-1

JPt100: JIS C 1604-1989, JIS C 1606-1989

L: Fe-CuNi, DIN 43710-1985

Pt100: JIS C 1604-1997, IEC 60751

U: Cu-CuNi, DIN 43710-1985

PL II: According to Platinel II electromotive force charts from BASF (previously Engelhard)

W: W5Re/W26Re, ASTM E988-1990

### ● Analog input

| Input type          | Current   |            | Voltage  |          |           |
|---------------------|---|------------|----------|----------|-----------|
| Input specification | 4 to 20 mA  | 0 to 20 mA | 1 to 5 V | 0 to 5 V | 0 to 10 V |
| Setting range       | Usable in the following ranges by scaling:<br>-1999 to 9999, -199.9 to 999.9,<br>-19.99 to 99.99 or -1.999 to 9.999 |            |          |          |           |
| Setting number      | 25  | 26         | 27       | 28       | 29        |

## Alarm type

Each alarm can be independently set to one of the following 19 alarm types. The default is 2: Upper limit. (see note.)

Auxiliary outputs are allocated for alarms. ON delays and OFF delays (0 to 999 s) can also be specified.

**Note:** In the default settings for models with HB or HS alarms, alarm 1 is set to a heater alarm (HA) and the Alarm Type 1 parameter is not displayed. To use alarm 1, set the output assignment to alarm 1.

| Set value   | Alarm type                                       | Alarm output operation                   |   | Description of function  |
|-------------|--|--|---|--|
|             |  | When alarm value X is positive           | When alarm value X is negative                    |  |
| 0           | Alarm function OFF                               | Output OFF                               |   | No alarm   |
| 1           | Upper- and lower-limit *1                        |  | *2  | Set the upward deviation in the set point for the alarm upper limit (H) and the lower deviation in the set point for the alarm lower limit (L). The alarm is ON when the PV is outside this deviation range. |
| 2 (default) | Upper-limit                                      |  |   | Set the upward deviation in the set point by setting the alarm value (X). The alarm is ON when the PV is higher than the SP by the deviation or more.  |
| 3           | Lower-limit                                      |  |   | Set the downward deviation in the set point by setting the alarm value (X). The alarm is ON when the PV is lower than the SP by the deviation or more.   |
| 4           | Upper- and lower-limit range *1                  |  | *3  | Set the upward deviation in the set point for the alarm upper limit (H) and the lower deviation in the set point for the alarm lower limit (L). The alarm is ON when the PV is inside this deviation range.  |
| 5           | Upper- and lower-limit with standby sequence *1  |  | *4  | A standby sequence is added to the upper- and lower-limit alarm (1). *6  |
| 6           | Upper-limit with standby sequence                |  |   | A standby sequence is added to the upper-limit alarm (2). *6   |
| 7           | Lower-limit with standby sequence                |  |   | A standby sequence is added to the lower-limit alarm (3). *6   |
| 8           | Absolute-value upper-limit                       |  |   | The alarm will turn ON if the process value is larger than the alarm value (X) regardless of the set point.  |
| 9           | Absolute-value lower-limit                       |  |   | The alarm will turn ON if the process value is smaller than the alarm value (X) regardless of the set point.   |
| 10          | Absolute-value upper-limit with standby sequence |  |   | A standby sequence is added to the absolute-value upper-limit alarm (8). *6  |
| 11          | Absolute-value lower-limit with standby sequence |  |   | A standby sequence is added to the absolute-value lower-limit alarm (9). *6  |
| 12          | LBA (alarm 1 type only)                          | -  |   | *7   |
| 13          | PV change rate alarm                             | -  |   | *8   |
| 14          | SP absolute-value upper-limit alarm              |  |   | This alarm type turns ON the alarm when the set point (SP) is higher than the alarm value (X).   |
| 15          | SP absolute-value lower-limit alarm              |  |   | This alarm type turns ON the alarm when the set point (SP) is lower than the alarm value (X).  |
| 16          | MV absolute-value upper-limit alarm *9           | Standard Control<br>                     | Standard Control<br>                              | This alarm type turns ON the alarm when the manipulated variable (MV) is higher than the alarm value (X).  |
|             |  | Heating/Cooling Control (Heating MV)<br> | Heating/Cooling Control (Heating MV)<br>Always ON |  |
| 17          | MV absolute-value lower-limit alarm *9           | Standard Control<br>                     | Standard Control<br>                              | This alarm type turns ON the alarm when the manipulated variable (MV) is lower than the alarm value (X).   |
|             |  | Heating/Cooling Control (Cooling MV)<br> | Heating/Cooling Control (Cooling MV)<br>Always ON |  |
| 18          | RSP absolute-value upper-limit alarm *10         |  |   | This alarm type turns ON the alarm when the remote SP (RSP) is higher than the alarm value (X).  |
| 19          | RSP absolute-value lower-limit alarm *10         |  |   | This alarm type turns ON the alarm when the remote SP (RSP) is lower than the alarm value (X).   |

\*1 With set values 1, 4 and 5, the upper and lower limit values can be set independently for each alarm type, and are expressed as "L" and "H."

\*2. Set value: 1, Upper- and lower-limit alarm



\*3. Set value: 4, Upper- and lower-limit range



\*4. Set value: 5, Upper- and lower-limit with standby sequence  
For Upper- and Lower-Limit Alarm Described Above \*2

- Case 1 and 2

- Always OFF when the upper-limit and lower-limit hysteresis overlaps.

- Case 3: Always OFF

\*5. Set value: 5, Upper- and lower-limit with standby sequence

- Always OFF when the upper-limit and lower-limit hysteresis overlaps.

\*6. Refer to the *E5EC Digital Temperature Controllers User's Manual* (Cat. No. H174) for information on the operation of the standby sequence.

\*7. Refer to the *E5EC Digital Temperature Controllers User's Manual* (Cat. No. H174) for information on the PV change rate alarm. This setting cannot be used with a position-proportional model.

\*8. Refer to the *E5EC Digital Temperature Controllers User's Manual* (Cat. No. H174) for information on the PV change rate alarm.

\*9. When heating/cooling control is performed, the MV absolute upper limit alarm functions only for the heating operation and the MV absolute lower limit alarm functions only for the cooling operation.

\*10. This value is displayed only when a remote SP input is used. It functions in both Local SP Mode and Remote SP Mode.

## Characteristics

|   |   |  |
|---|---|--|
| <b>Indication accuracy<br/>(at the ambient temperature of<br/>23°C)</b> | Thermocouple: ( $\pm 0.3\%$ of PV or $\pm 1^\circ\text{C}$ , whichever is greater) $\pm 1$ digit max. *1<br>Platinum resistance thermometer: ( $\pm 0.2\%$ of PV or $\pm 0.8^\circ\text{C}$ , whichever is greater) $\pm 1$ digit<br>Analog input: $\pm 0.2\%$ FS $\pm 1$ digit max.<br>CT input: $\pm 5\%$ FS $\pm 1$ digit max.<br>Potentiometer input: $\pm 5\%$ FS $\pm 1$ digit max.   |  |
| <b>Transfer output accuracy</b>   | $\pm 0.3\%$ FS max.   |  |
| <b>Remote SP Input Type</b>   | $\pm 0.2\%$ FS $\pm 1$ digit max.   |  |
| <b>Influence of temperature *2</b>                                      | Thermocouple input (R, S, B, W, PL II): ( $\pm 1\%$ of PV or $\pm 10^\circ\text{C}$ , whichever is greater) $\pm 1$ digit max.<br>Other thermocouple input: ( $\pm 1\%$ of PV or $\pm 4^\circ\text{C}$ , whichever is greater) $\pm 1$ digit max. *3<br>Platinum resistance thermometer: ( $\pm 1\%$ of PV or $\pm 2^\circ\text{C}$ , whichever is greater) $\pm 1$ digit max.  |  |
| <b>Influence of voltage *2</b>  | Analog input: $\pm 1\%$ FS $\pm 1$ digit max.<br>CT input: $\pm 5\%$ FS $\pm 1$ digit max.<br>Remote SP input: $\pm 1\%$ FS $\pm 1$ digit max.  |  |
| <b>Input sampling period</b>  | 50ms  |  |
| <b>Hysteresis</b>   | Temperature input: 0.1 to 999.9°C or °F (in units of 0.1°C or °F)<br>Analog input: 0.01% to 99.99% FS (in units of 0.01% FS)  |  |
| <b>Proportional band (P)</b>  | Temperature input: 0.1 to 999.9°C or °F (in units of 0.1°C or °F)<br>Analog input: 0.1 to 999.9% FS (in units of 0.1% FS)   |  |
| <b>Integral time (I)</b>  | Standard, heating/cooling, or Position-proportional (Close): 0 to 9999 s (in units of 1 s), 0.0 to 999.9 s (in units of 0.1 s)<br>Position-proportional (Floating): 1 to 9999 s (in units of 1 s), 0.1 to 999.9 s (in units of 0.1 s)*4   |  |
| <b>Derivative time (D)</b>  | 0 to 9999 s (in units of 1 s), 0.0 to 999.9 s (in units of 0.1 s) *4  |  |
| <b>Proportional band (P) for cooling</b>                                | Temperature input: 0.1 to 999.9°C or °F (in units of 0.1°C or °F)<br>Analog input: 0.1 to 999.9% FS (in units of 0.1% FS)   |  |
| <b>Integral time (I) for cooling</b>                                    | 0 to 9999 s (in units of 1 s), 0.0 to 999.9 s (in units of 0.1 s) *4  |  |
| <b>Derivative time (D) for cooling</b>                                  | 0 to 9999 s (in units of 1 s), 0.0 to 999.9 s (in units of 0.1 s) *4  |  |
| <b>Control period</b>   | 0.1, 0.2, 0.5, 1 to 99 s (in units of 1 s)  |  |
| <b>Manual reset value</b>   | 0.0 to 100.0% (in units of 0.1%)  |  |
| <b>Alarm setting range</b>  | -1999 to 9999 (decimal point position depends on input type)  |  |
| <b>Influence of signal source resistance</b>                            | Thermocouple: $0.1^\circ\text{C}/\Omega$ max. (100 $\Omega$ max.)<br>Platinum resistance thermometer: $0.1^\circ\text{C}/\Omega$ max. (10 $\Omega$ max.)  |  |
| <b>Insulation resistance</b>  | 20 M $\Omega$ min. (at 500 VDC)   |  |
| <b>Dielectric strength</b>  | 2,300 VAC, 50/60 Hz for 1 min between terminals of different charge   |  |
| <b>Vibration</b>  | <b>Malfunction</b>  | 10 to 55 Hz, 20 m/s <sup>2</sup> for 10 min each in X, Y, and Z directions                 |
|   | <b>Resistance</b>   | 10 to 55 Hz, 20 m/s <sup>2</sup> for 2 hrs each in X, Y, and Z directions                  |
| <b>Shock</b>  | <b>Malfunction</b>  | 100 m/s <sup>2</sup> , 3 times each in X, Y, and Z directions                              |
|   | <b>Resistance</b>   | 300 m/s <sup>2</sup> , 3 times each in X, Y, and Z directions                              |
| <b>Weight</b>   | <b>E5EC</b>   | Controller: Approx. 210 g, Mounting Brackets: Approx. 4 g $\times$ 2                       |
|   | <b>E5AC</b>   | Controller: Approx. 250 g, Mounting Brackets: Approx. 4 g $\times$ 2                       |
| <b>Degree of protection</b>   | Front panel: IP66, Rear case: IP20, Terminals: IP00   |  |
| <b>Memory protection</b>  | Non-volatile memory (number of writes: 1,000,000 times)   |  |
| <b>Setup Tool</b>   | CX-Thermo version 4.5 or higher   |  |
| <b>Setup Tool port</b>  | E5EC/E5AC top panel: An E58-CIFQ2 USB-Serial Conversion Cable is used to connect to a USB port on the computer.*5   |  |
|   | E5EC/E5AC front panel: An E58-CIFQ2 USB-Serial Conversion Cable and E58-CIFQ2-E Conversion Cable are used together to connect to a USB port on the computer.*5  |  |
| <b>Standards</b>  | <b>Approved standards</b>   | UL 61010-1, CSA C22.2 No. 611010-1 (evaluated by UL), Korean Radio Waves Act (Act 10564)   |
|   | <b>Conformed standards</b>  | EN 61010-1 (IEC 61010-1): Pollution level 2, overcurrent category II, Lloyd's standards *6 |
| <b>EMC</b>  | EMI<br>Radiated Interference Electromagnetic Field Strength: EN 55011 Group 1, class A<br>Noise Terminal Voltage: EN 55011 Group 1, class A<br>EMS:<br>EN 61326<br>ESD Immunity:<br>EN 61000-4-2<br>Electromagnetic Field Immunity:<br>EN 61000-4-3<br>Burst Noise Immunity:<br>EN 61000-4-4<br>Conducted Disturbance Immunity:<br>EN 61000-4-6<br>Surge Immunity:<br>EN 61000-4-5<br>Voltage Dip/Interrupting Immunity:<br>EN 61000-4-11 |  |

\*1 The indication accuracy of K thermocouples in the -200 to 1300°C range, T and N thermocouples at a temperature of -100°C max., and U and L thermocouples at any temperatures is  $\pm 2^\circ\text{C} \pm 1$  digit max. The indication accuracy of the B thermocouple at a temperature of 400°C max. is not specified. The indication accuracy of B thermocouples at a temperature of 400 to 800°C is  $\pm 3^\circ\text{C}$  max. The indication accuracy of the R and S thermocouples at a temperature of 200°C max. is  $\pm 3^\circ\text{C} \pm 1$  digit max. The indication accuracy of W thermocouples is ( $\pm 0.3\%$  of PV or  $\pm 3^\circ\text{C}$ , whichever is greater)  $\pm 1$  digit max. The indication accuracy of PL II thermocouples is ( $\pm 0.3\%$  of PV or  $\pm 2^\circ\text{C}$ , whichever is greater)  $\pm 1$  digit max.

\*2 Ambient temperature: -10°C to 23°C to 55°C, Voltage range: -15% to 10% of rated voltage

\*3 K thermocouple at -100°C max.:  $\pm 10^\circ\text{C}$  max.

\*4 The unit is determined by the setting of the Integral/Derivative Time Unit parameter.

\*5 External communications (RS-485) and USB-serial conversion cable communications can be used at the same time.

\*6 Refer to information on maritime standards in *Shipping Standards* on page 52 for compliance with Lloyd's Standards.

## USB-Serial Conversion Cable

|                               |   |
|-------------------------------|---|
| Applicable OS                 | Windows 2000, XP, Vista, or 7   |
| Applicable software           | CX-Thermo version 4.5 or higher   |
| Applicable models             | E5□C Series and E5CB Series   |
| USB interface standard        | Conforms to USB Specification 2.0.  |
| DTE speed                     | 38,400 bps  |
| Connector specifications      | Computer: USB (type A plug)<br>Digital Temperature Controller: Special serial connector           |
| Power supply                  | Bus power (Supplied from USB host controller.)*   |
| Power supply voltage          | 5 VDC   |
| Current consumption           | 450 mA max.   |
| Output voltage                | 4.7±0.2 VDC<br>(Supplied from USB-Serial Conversion Cable to the Digital Temperature Controller.) |
| Output current                | 250 mA max.<br>(Supplied from USB-Serial Conversion Cable to the Digital Temperature Controller.) |
| Ambient operating temperature | 0 to 55°C (with no condensation or icing)   |
| Ambient operating humidity    | 10% to 80%  |
| Storage temperature           | -20 to 60°C (with no condensation or icing)   |
| Storage humidity              | 10% to 80%  |
| Altitude                      | 2,000 m max.  |
| Weight                        | Approx. 120 g   |

Windows is a registered trademark of Microsoft Corporation in the United States and/or other countries.

\* Use a high-power port for the USB port.

**Note:** A driver must be installed on the computer. Refer to the *Instruction Manual* included with the Cable for the installation procedure.

## Communications Specifications

|                                     |   |
|-------------------------------------|---|
| Transmission line connection method | RS-485: Multidrop   |
| Communications                      | RS-485 (two-wire, half duplex)  |
| Synchronization method              | Start-stop synchronization  |
| Protocol                            | CompoWay/F, or Modbus   |
| Baud rate                           | 19200, 38400, or 57600 bps  |
| Transmission code                   | ASCII   |
| Data bit length*                    | 7 or 8 bits   |
| Stop bit length*                    | 1 or 2 bits   |
| Error detection                     | Vertical parity (none, even, odd)<br>Block check character (BCC) with CompoWay/F or CRC-16 Modbus |
| Flow control                        | None  |
| Interface                           | RS-485  |
| Retry function                      | None  |
| Communications buffer               | 217 bytes   |
| Communications response wait time   | 0 to 99 ms<br>Default: 20 ms  |

\* The baud rate, data bit length, stop bit length, and vertical parity can be individually set using the Communications Setting Level.

## Communications Functions

|                             |   |
|-----------------------------|---|
| Programless communications* | You can use the memory in the PLC to read and write E5□C parameters, start and stop operation, etc. The E5□C automatically performs communications with PLCs. No communications programming is required.<br>Number of connected Temperature Controllers: 32 max.<br>Applicable PLCs<br>OMRON PLCs<br>SYSMAC CS Series, CJ Series, or CP Series<br>Mitsubishi Electric PLCs<br>MELSEC Q Series or L Series |
|-----------------------------|---|

|                                    |   |
|------------------------------------|---|
| Communications between components* | When Digital Temperature Controllers are connected, the parameters can be copied from the Digital Temperature Controller that is set as the master to the Digital Temperature Controllers that are set as slaves.<br>Number of connected Digital Temperature Controllers: 32 max. (including master)<br>When Digital Temperature Controllers are connected, set points and RUN/STOP commands can be sent from the Digital Temperature Controller that is set as the master to the Digital Temperature Controllers that are set as slaves.<br>Slope and offsets can be set for the set point.<br>Number of connected Digital Temperature Controllers: 32 max. (including master) |
|------------------------------------|---|

MELSEC is a registered trademark of Mitsubishi Electric Corporation.

\* A Temperature Controller with version 1.1 or higher is required.

## Current Transformer (Order Separately) Ratings

|                            |   |
|----------------------------|---|
| Dielectric strength        | 1,000 VAC for 1 min                               |
| Vibration resistance       | 50 Hz, 98 m/s <sup>2</sup>                        |
| Weight                     | E54-CT1: Approx. 11.5 g,<br>E54-CT3: Approx. 50 g |
| Accessories (E54-CT3 only) | Armatures (2)<br>Plugs (2)                        |

## Heater Burnout Alarms and SSR Failure Alarms

|   |  |
|---|--|
| CT input (for heater current detection) | Models with detection for singlephase heaters: One input<br>Models with detection for singlephase or three-phase heaters: Two inputs |
| Maximum heater current                  | 50 A AC  |
| Input current indication accuracy       | ±5% FS ±1 digit max.   |
| Heater burnout alarm setting range *1   | 0.1 to 49.9 A (in units of 0.1 A)<br>Minimum detection ON time: 100 ms *3  |
| SSR failure alarm setting range *2      | 0.1 to 49.9 A (in units of 0.1 A)<br>Minimum detection OFF time: 100 ms *4   |

- For heater burnout alarms, the heater current will be measured when the control output is ON, and the output will turn ON if the heater current is lower than the set value (i.e., heater burnout detection current value).
- For SSR failure alarms, the heater current will be measured when the control output is OFF, and the output will turn ON if the heater current is higher than the set value (i.e., SSR failure detection current value).
- The value is 30 ms for a control period of 0.1 s or 0.2 s.
- The value is 35 ms for a control period of 0.1 s or 0.2 s.

## Electrical Life Expectancy Curve for Relays (Reference Values)





# External Connections

## E5EC/E5AC

E5EC-□□ 4 □ 5 M - □□□□      E5AC-□□ 4 □ 5 M - □□□□  
 (1) (2) (3) (4) (5) (6)      (1) (2) (3) (4) (5) (6)

Terminal type

Terminal type

The E5EC is set for a K-type thermocouple (input type = 5) by default. An input error (5.ERR) will occur if the input type setting does not agree with the temperature sensor. Check the input type.



- Note:**
1. The application of the terminals depends on the model.
  2. Do not wire the terminals that are shown with a gray background.
  3. When complying with EMC standards, the cable that connects the sensor must be 30 m or less. If the cable length exceeds 30 m, compliance with EMC standards will not be possible.
  4. Connect M3 crimped terminals.

# Isolation/Insulation Block Diagrams

## Models with 4 Auxiliary Outputs



**Note:** Auxiliary outputs 1 to 2 and 3 to 4 are not insulated.

# E5EC/E5AC

## Nomenclature

### E5EC



### E5AC



## Dimensions

## Controllers

## E5EC



The Setup Tool port is on the top of the Temperature Controller. It is used to connect the Temperature Controller to the computer to use the Setup Tool. The E58-CIFQ2 USB-Serial Conversion Cable is required to make the connection. Refer to the instructions that are provided with the USB-Serial Conversion Cable for the connection procedure.

**Note:** Do not leave the USB-Serial Conversion Cable connected when you use the Temperature Controller.

## Mounted Separately



## Group Mounted \*

(48 × number of units - 2.5)<sup>+1.0</sup><sub>0</sub>



\* Selections for Control Outputs 1 and 2: QQ, QR, RR, CC, PR, or CQ. If you also specify 011, 013, or 014 for the option selection and use group mounting, the ambient temperature must be 45°C or less. If the ambient temperature is 55°C, maintain the following mounting spaces between Controllers.



- Recommended panel thickness is 1 to 8 mm.
- Group mounting is not possible in the vertical direction. (Maintain the specified mounting space between Controllers.)
- To mount the Controller so that it is waterproof, insert the waterproof packing onto the Controller.
- When two or more Controllers are mounted, make sure that the surrounding temperature does not exceed the allowable operating temperature specified in the specifications.
- To attach the USB-Serial Conversion Cable to the control panel, use a panel thickness of 1 to 2.5 mm.

# E5EC/E5AC

## E5AC



The Setup Tool port is on the top of the Temperature Controller.  
 It is used to connect the Temperature Controller to the computer to use the Setup Tool.  
 The E58-CIFQ2 USB-Serial Conversion Cable is required to make the connection.  
 Refer to the instructions that are provided with the USB-Serial Conversion Cable for the connection procedure.  
**Note:** Do not leave the USB-Serial Conversion Cable connected when you use the Temperature Controller.

### Mounted Separately



### Group Mounted \*

$$(96 \times \text{number of units} - 3.5)^{+1.0}_0$$



Group mounting does not allow waterproofing.

- Recommended panel thickness is 1 to 8 mm.
- Group mounting is not possible in the vertical direction. (Maintain the specified mounting space between Controllers.)
- To mount the Controller so that it is waterproof, insert the waterproof packing onto the Controller.
- When two or more Controllers are mounted, make sure that the surrounding temperature does not exceed the allowable operating temperature specified in the specifications.
- To attach the USB-Serial Conversion Cable to the control panel, use a panel thickness of 1 to 2.5 mm.

**Accessories (Order Separately)**

● **USB-Serial Conversion Cable**  
E58-CIFQ2



● **Conversion Cable**  
E58-CIFQ2-E

Conversion Cable



Connecting to the E58-CIFQ2 USB-Serial Conversion Cable



**Note:** Always use this product together with the E58-CIFQ2.

● **Terminal Covers**  
E53-COV24 (Three Covers provided.)



● **Waterproof Packing**  
Y92S-P9 (for DIN 48 × 96)



Y92S-P10 (for DIN 96 × 96)

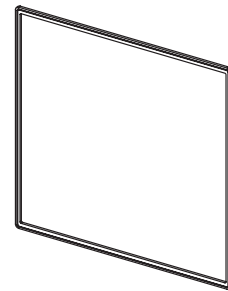

The Waterproof Packing is provided with the Temperature Controller.  
The degree of protection when the Waterproof Packing is used is IP66.  
Also, keep the Port Cover on the front-panel Setup Tool port of the E5EC/E5AC securely closed.  
To maintain an IP66 degree of protection, the Waterproof Packing and the Port Cover for the front-panel Setup Tool port must be periodically replaced because they may deteriorate, shrink, or harden depending on the operating environment. The replacement period will vary with the operating environment.  
Check the required period in the actual application. Use 3 years or sooner as a guideline.  
If a waterproof structure is not required, then the Waterproof Packing does not need to be installed.

● **Setup Tool Port Cover for top panel**  
Y92S-P7



Order this Port Cover separately if the Port Cover on the front-panel Setup Tool port is lost or damaged. The Waterproof Packing must be periodically replaced because it may deteriorate, shrink, or harden depending on the operating environment.

● **Mounting Adapter**  
Y92F-51 (for DIN 48 × 96)

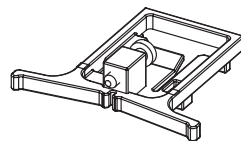

One pair is provided with the Controller. Order this Adapter separately if it becomes lost or damaged.

# E5EC/E5AC

## ● Watertight Cover Y92A-49N (48 × 96)



## ● Watertight Cover Y92A-96N (96 × 96)



## ● Current Transformers

### E54-CT1



### Thru-current (Io) vs. Output Voltage (Eo) (Reference Values)

#### E54-CT1

Maximum continuous heater current: 50 A (50/60 Hz)  
Number of windings: 400±2  
Winding resistance: 18±2 Ω



### E54-CT3



### Thru-current (Io) vs. Output Voltage (Eo) (Reference Values)

#### E54-CT3

Maximum continuous heater current: 120 A (50/60 Hz)  
(Maximum continuous heater current for an OMRON Digital Temperature Controller is 50 A.)

Number of windings: 400±2  
Winding resistance: 8±0.8 Ω



### E54-CT3 Accessories

#### ● Armature



#### ● Plug

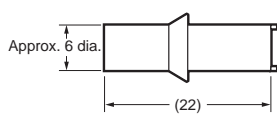

#### Connection Example





# Digital Temperature Controller

# E5DC

(22.5 mm Wide, and DIN Track-mounting Type)

The E5DC Mounts to DIN Track and Is Ideal for Connections to HMIs and PLCs.

It provides the Same Easy Operation and Advanced Performance as the Rest of the E5□C Series.

- A slim body at 85 × 22.5 mm (D × W) that fits into narrow control panels and mounts to DIN Track.
- Removable terminal block for easy replacement to simplify maintenance.
- High-speed sampling at 50 ms for applications with high-speed temperature increases.
- Easy connections to a PLC with programless communications.
- Set up the Controller without wiring the power supply by connecting to the computer with a Communications Conversion Cable (sold separately). Setup is easy with the CX-Thermo (sold separately).
- Models are available with up to 2 auxiliary outputs and 1 event input to complete basic functions.
- A white PV display (height: 8.5 mm) is easy to read when setting up, checking alarms, and making settings in a control panel.



22.5 mm Wide, and  
DIN Track-mounting Type  
E5DC

Refer to your OMRON website for the most recent information on applicable safety standards.

Refer to **Safety Precautions** on page 50.

## Main I/O Functions



This datasheet is provided as a guideline for selecting products.

Be sure to refer to the following manuals for application precautions and other information required for operation before attempting to use the product.

E5□C Digital Temperature Controllers User's Manual (Cat. No. H174)

E5□C Digital Temperature Controllers Communications Manual (Cat. No. H175)



## Model Number Legend and Standard Models

### Model Number Legend

E5DC-□□ □□□□-□□□□ (Example: E5DC-RX0ASM-015)

① ② ③ ④ ⑤ ⑥

| Model | ①                | ②                        | ③                    | ④             | ⑤          | ⑥       | Meaning   |
|-------|------------------|--------------------------|----------------------|---------------|------------|---------|---|
|       | Control output 1 | No. of auxiliary outputs | Power supply voltage | Terminal type | Input type | Options |   |
| E5DC  |                  |                          |                      |               |            |         | 22.5 mm wide and mounts to DIN Track                                  |
|       |                  |                          |                      |               |            |         | <b>Control output 1</b>   |
|       | RX               |                          |                      |               |            |         | Relay output  |
|       | QX               |                          |                      |               |            |         | Voltage output<br>(for driving SSR)                                   |
|       | CX               |                          |                      |               |            |         | Linear current output *5  |
|       |                  | 0                        |                      |               |            |         | None  |
|       |                  | 2                        |                      |               |            |         | 2 (one common)  |
|       |                  |                          | A                    |               |            |         | 100 to 240 VAC  |
|       |                  |                          | D                    |               |            |         | 24 VAC/DC   |
|       |                  |                          |                      | S             |            |         | Screw terminals   |
|       |                  |                          |                      |               | M          |         | Universal input   |
|       |                  |                          |                      |               |            |         | <b>HB alarm and HS alarm</b> <b>Communications</b> <b>Event input</b> |
|       |                  |                          |                      |               | *1         | 000     | ---    ---    ---   |
|       |                  |                          |                      |               | *2         | 002     | 1    RS-485    ---  |
|       |                  |                          |                      |               | *3         | 015     | ---    RS-485    ---  |
|       |                  |                          |                      |               | *4         | 016     | ---    ---    1   |
|       |                  |                          |                      |               | *2         | 017     | 1    ---    1   |

\*1 Option 000 can be selected only if two auxiliary outputs are selected.

\*2 Options 002 and 017 can be selected only if the control output is a relay output or voltage output and two auxiliary outputs are selected.

\*3 Option 015 cannot be selected if the control output is a relay output or voltage output and two auxiliary outputs are selected.

\*4 Options 016 can be selected only if the control output is a linear current output and two auxiliary outputs are selected.

\*5 The control output cannot be used as a transfer output.

### List of Models

| Control output                      | No. of auxiliary outputs | Options                           |                     |                | Model                |                      |
|-------------------------------------|--------------------------|-----------------------------------|---------------------|----------------|----------------------|----------------------|
|                                     |                          | HB alarm and HS alarm             | No. of event inputs | Communications | Power supply voltage | Power supply voltage |
|                                     |                          |                                   |                     |                | 100 to 240 VAC       | 24 VAC/DC            |
| Relay output                        | ---                      | ---                               | ---                 | RS-485         | E5DC-RX0ASM-015      | E5DC-RX0DSM-015      |
|                                     |                          |                                   |                     | ---            | E5DC-RX2ASM-000      | E5DC-RX2DSM-000      |
|                                     | 2                        | Detection for single-phase heater | 1                   | RS-485         | E5DC-RX2ASM-002      | E5DC-RX2DSM-002      |
|                                     |                          |                                   |                     | ---            | E5DC-RX2ASM-017      | E5DC-RX2DSM-017      |
| Voltage output<br>(for driving SSR) | ---                      | ---                               | ---                 | RS-485         | E5DC-QX0ASM-015      | E5DC-QX0DSM-015      |
|                                     |                          |                                   |                     | ---            | E5DC-QX2ASM-000      | E5DC-QX2DSM-000      |
|                                     | 2                        | Detection for single-phase heater | 1                   | RS-485         | E5DC-QX2ASM-002      | E5DC-QX2DSM-002      |
|                                     |                          |                                   |                     | ---            | E5DC-QX2ASM-017      | E5DC-QX2DSM-017      |
| Linear current output               | ---                      | ---                               | ---                 | RS-485         | E5DC-CX0ASM-015      | E5DC-CX0DSM-015      |
|                                     |                          |                                   |                     | ---            | E5DC-CX2ASM-000      | E5DC-CX2DSM-000      |
|                                     | 2                        | ---                               | 1                   | RS-485         | E5DC-CX2ASM-015      | E5DC-CX2DSM-015      |
|                                     |                          |                                   |                     | ---            | E5DC-CX2ASM-016      | E5DC-CX2DSM-016      |

**Note:** These products are sold as a set with a terminal block (i.e., Terminal Unit).

### Heating and Cooling Control

#### ●Using Heating and Cooling Control

① Control Output Assignment

An auxiliary output is used as the cooling control output.

② Control

If PID control is used, you can set PID control separately for heating and cooling.

This allows you to handle control systems with different heating and cooling response characteristics.

## Optional Products (Order Separately)

### USB-Serial Conversion Cable

| Model     |
|-----------|
| E58-CIFQ2 |

### Conversion Cable

| Model       |
|-------------|
| E58-CIFQ2-E |

**Note:** Always use this product together with the E58-CIFQ2. This Cable is used to connect to the front-panel Setup Tool port.

### Current Transformers (CTs)

| Hole diameter | Model   |
|---------------|---------|
| 5.8 mm        | E54-CT1 |
| 12.0 mm       | E54-CT3 |

### Mounting Adapters

| Model   |
|---------|
| Y92F-53 |

### Short Bars

| Model    |
|----------|
| Y92S-P11 |

### CX-Thermo Support Software

| Model       |
|-------------|
| EST2-2C-MV4 |

**Note:** CX-Thermo version 4.6 or higher is required for the E5DC. For the system requirements for the CX-Thermo, refer to information on the EST2-2C-MV4 on the OMRON website ([www.ia.omron.com](http://www.ia.omron.com)).

### End Plate

| Model |
|-------|
| PFP-M |

### Spacer

| Model |
|-------|
| PFP-S |

### DIN Tracks

| Model    |
|----------|
| PFP-100N |
| PFP-50N  |

### Unit Labels

| Model   |
|---------|
| Y92S-L2 |

## Specifications

### Ratings

|                                      |   |   |
|--------------------------------------|---|---|
| <b>Power supply voltage</b>          | A in model number: 100 to 240 VAC, 50/60 Hz<br>D in model number: 24 VAC, 50/60 Hz; 24 VDC  |   |
| <b>Operating voltage range</b>       | 85% to 110% of rated supply voltage   |   |
| <b>Power consumption</b>             | 4.9 VA max. at 100 to 240 VAC, and 2.8 VA max. at 24 VDC or 1.5 W max. at 24 VDC  |   |
| <b>Sensor input</b>                  | Temperature input<br>Thermocouple: K, J, T, E, L, U, N, R, S, B, W, or PL II<br>Platinum resistance thermometer: Pt100 or JPt100<br>Infrared temperature sensor (ES1B): 10 to 70°C, 60 to 120°C, 115 to 165°C, or 140 to 260°C<br>Analog input<br>Current input: 4 to 20 mA or 0 to 20 mA<br>Voltage input: 1 to 5 V, 0 to 5 V, or 0 to 10 V  |   |
| <b>Input impedance</b>               | Current input: 150 Ω max., Voltage input: 1 MΩ min. (Use a 1:1 connection when connecting the ES2-HB/THB.)  |   |
| <b>Control method</b>                | ON/OFF control or 2-PID control (with auto-tuning)  |   |
| <b>Control output</b>                | <b>Relay output</b>   | SPST-NO, 250 VAC, 3 A (resistive load), electrical life: 100,000 operations, minimum applicable load: 5 V, 10 mA                    |
|                                      | <b>Voltage output (for driving SSR)</b>   | Output voltage 12 VDC ±20% (PNP), max. Load current: 21 mA, with short-circuit protection circuit                                   |
|                                      | <b>Linear current output</b>  | 4 to 20 mA DC/0 to 20 mA DC, load: 500 Ω max., resolution: Approx. 10,000   |
| <b>Auxiliary outputs</b>             | <b>Number of outputs</b>  | 2 (depends on model)  |
|                                      | <b>Output specifications</b>  | SPST-NO relay outputs: 250 VAC, 2 A (resistive load),<br>Electrical life: 100,000 operations, Minimum applicable load: 10 mA at 5 V |
| <b>Event inputs</b>                  | <b>Number of inputs</b>   | 1 (depends on model)  |
|                                      | <b>External contact input specifications</b>  | Contact input ON: 1 kΩ max., OFF: 100 kΩ min.   |
|                                      |   | Non-contact input ON: Residual voltage 1.5 V max.; OFF: Leakage current 0.1 mA max.<br>Current flow: approx. 7 mA per contact       |
| <b>Setting method</b>                | Digital setting using front panel keys  |   |
| <b>Indication method</b>             | 11-segment digital displays and individual indicators<br>Character height: PV: 8.5 mm, SV: 8.0 mm   |   |
| <b>Multi SP</b>                      | Up to eight set points (SP0 to SP7) can be saved and selected using the event inputs, key operations, or serial communications.*  |   |
| <b>Bank switching</b>                | None  |   |
| <b>Other functions</b>               | Manual output, heating/cooling control, loop burnout alarm, SP ramp, other alarm functions, heater burn-out (HB) alarm (including SSR failure (HS) alarm), 40% AT, 100% AT, MV limiter, input digital filter, self tuning, robust tuning, PV input shift, run/stop, protection functions, extraction of square root, MV change rate limit, simple calculations, temperature status display, simple programming, moving average of input value, and display brightness setting |   |
| <b>Ambient operating temperature</b> | -10 to 55°C (with no condensation or icing), for 3-year warranty: -10 to 50°C (with no condensation or icing)   |   |
| <b>Ambient operating humidity</b>    | 25% to 85%  |   |
| <b>Storage temperature</b>           | -25 to 65°C (with no condensation or icing)   |   |

\* Only two set points are selectable for event inputs.

## Input Ranges

### ● Thermocouple/Platinum Resistance Thermometer (Universal inputs)



Shaded settings are the default settings.

The applicable standards for the input types are as follows:

K, J, T, E, N, R, S, B: JIS C 1602-1995, IEC 60584-1

JPt100: JIS C 1604-1989, JIS C 1606-1989

L: Fe-CuNi, DIN 43710-1985

Pt100: JIS C 1604-1997, IEC 60751

U: Cu-CuNi, DIN 43710-1985

PL II: According to Platinel II electromotive force charts from BASF (previously Engelhard)

W: W5Re/W26Re, ASTM E988-1990

### ● Analog input

| Input type          | Current   |            | Voltage  |          |           |
|---------------------|---|------------|----------|----------|-----------|
| Input specification | 4 to 20 mA  | 0 to 20 mA | 1 to 5 V | 0 to 5 V | 0 to 10 V |
| Setting range       | Usable in the following ranges by scaling:<br>-1999 to 9999, -199.9 to 999.9,<br>-19.99 to 99.99 or -1.999 to 9.999 |            |          |          |           |
| Setting number      | 25  | 26         | 27       | 28       | 29        |

## Alarm Types

Each alarm can be independently set to one of the following 17 alarm types. The default is 2: Upper limit. (See note.)

Auxiliary outputs are allocated to alarms. ON delays and OFF delays (0 to 999 s) can also be specified.

**Note:** In the default settings for models with HB or HS alarms, alarm 1 is set to a heater alarm (HA) and the Alarm Type 1 parameter is not displayed.

To use alarm 1, set the output assignment to alarm 1.

| Set value   | Alarm type                                       | Alarm output operation  |   | Description of function  |
|-------------|--|---|---|--|
|             |  | When alarm value X is positive  | When alarm value X is negative  |  |
| 0           | Alarm function OFF                               | Output OFF  |   | No alarm   |
| 1           | Upper- and lower-limit *1                        |    | *2  | Set the upward deviation in the set point for the alarm upper limit (H) and the lower deviation in the set point for the alarm lower limit (L). The alarm is ON when the PV is outside this deviation range. |
| 2 (default) | Upper-limit                                      |    |                        | Set the upward deviation in the set point by setting the alarm value (X). The alarm is ON when the PV is higher than the SP by the deviation or more.  |
| 3           | Lower-limit                                      |    |                        | Set the downward deviation in the set point by setting the alarm value (X). The alarm is ON when the PV is lower than the SP by the deviation or more.   |
| 4           | Upper- and lower-limit range *1                  |    | *3  | Set the upward deviation in the set point for the alarm upper limit (H) and the lower deviation in the set point for the alarm lower limit (L). The alarm is ON when the PV is inside this deviation range.  |
| 5           | Upper- and lower-limit with standby sequence *1  |    | *4  | A standby sequence is added to the upper- and lower-limit alarm (1). *6  |
| 6           | Upper-limit with standby sequence                |   |                       | A standby sequence is added to the upper-limit alarm (2). *6   |
| 7           | Lower-limit with standby sequence                |    |                      | A standby sequence is added to the lower-limit alarm (3). *6   |
| 8           | Absolute-value upper-limit                       |    |                      | The alarm will turn ON if the process value is larger than the alarm value (X) regardless of the set point.  |
| 9           | Absolute-value lower-limit                       |    |                      | The alarm will turn ON if the process value is smaller than the alarm value (X) regardless of the set point.   |
| 10          | Absolute-value upper-limit with standby sequence |    |                      | A standby sequence is added to the absolute-value upper-limit alarm (8). *6  |
| 11          | Absolute-value lower-limit with standby sequence |    |                      | A standby sequence is added to the absolute-value lower-limit alarm (9). *6  |
| 12          | LBA (alarm 1 type only)                          | -   |   | *7   |
| 13          | PV change rate alarm                             | -   |   | *8   |
| 14          | SP absolute-value upper-limit alarm              |    |                      | This alarm type turns ON the alarm when the set point (SP) is higher than the alarm value (X).   |
| 15          | SP absolute-value lower-limit alarm              |    |                      | This alarm type turns ON the alarm when the set point (SP) is lower than the alarm value (X).  |
| 16          | MV absolute-value upper-limit alarm *9           | Standard Control<br>                     | Standard Control<br> | This alarm type turns ON the alarm when the manipulated variable (MV) is higher than the alarm value (X).  |
|             |  | Heating/Cooling Control (Heating MV)<br> | Heating/Cooling Control (Heating MV)<br>Always ON   |  |
| 17          | MV absolute-value lower-limit alarm *9           | Standard Control<br>                     | Standard Control<br> | This alarm type turns ON the alarm when the manipulated variable (MV) is lower than the alarm value (X).   |
|             |  | Heating/Cooling Control (Cooling MV)<br> | Heating/Cooling Control (Cooling MV)<br>Always ON   |  |

\*1 With set values 1, 4, and 5, the upper- and lower-limit values can be set independently for each alarm type, and are expressed as "L" and "H."

\*2 Set value: 1, Upper- and lower-limit alarm



\*3 Set value: 4, Upper- and lower-limit range



- \*4 Set value: 5, Upper- and lower-limit with standby sequence For Upper- and Lower-Limit Alarm Described Above at \*2
  - In cases 1 and 2 above, the alarm is always OFF if the upper- and lower-limit hysteresis overlaps.
  - In case 3, the alarm is always OFF.
- \*5 Set value: 5, Upper- and lower-limit alarm with standby sequence The alarm is always OFF if upper- and lower-limit hysteresis overlaps.
- \*6 Refer to the *E5DC Digital Temperature Controllers User's Manual* (Cat. No. H174) for information on the operation of the standby sequence.
- \*7 Refer to the *E5DC Digital Temperature Controllers User's Manual* (Cat. No. H174) for information on the LBA.
- \*8 Refer to the *E5DC Digital Temperature Controllers User's Manual* (Cat. No. H174) for information on the PV change rate alarm.
- \*9 When heating/cooling control is performed, the MV absolute-value upper-limit alarm functions only for the heating operation and the MV absolute-value lower-limit alarm functions only for the cooling operation.

## Characteristics

|   |  |  |
|---|--|--|
| <b>Indication accuracy (when mounted individually, ambient temperature of 23°C)</b> | Thermocouple:*1 (±0.3% of PV or ±1°C, whichever is greater) ±1 digit max.<br>Platinum resistance thermometer: (±0.2% of PV or ±0.8°C, whichever is greater) ±1 digit max.<br>Analog input: ±0.2% FS ±1 digit max.<br>CT input: ±5% FS ±1 digit max.  |  |
| <b>Influence of temperature *2</b>  | Thermocouple input (R, S, B, W, PL II): (±1% of PV or ±10°C, whichever is greater) ±1 digit max.<br>Other thermocouple input: (±1% of PV or ±4°C, whichever is greater) ±1 digit max. *3<br>Platinum resistance thermometer: (±1% of PV or ±2°C, whichever is greater) ±1 digit max.<br>Analog input: ±1% FS ±1 digit max.<br>CT input: ±5% FS ±1 digit max.                     |  |
| <b>Influence of voltage *2</b>  |  |  |
| <b>Installation influence (E5DC only)</b>   | R, S, B, W, or PLII thermocouple: (±1% of PV or ±10°C, whichever is greater) ±1 digit max.<br>Other thermocouple: (±1% of PV or ±4°C, whichever is greater) ±1 digit max. *3   |  |
| <b>Input sampling period</b>  | 50 ms  |  |
| <b>Hysteresis</b>   | Temperature input: 0.1 to 999.9°C or °F (in units of 0.1°C or °F)<br>Analog input: 0.01% to 99.99% FS (in units of 0.01% FS)   |  |
| <b>Proportional band (P)</b>  | Temperature input: 0.1 to 999.9°C or °F (in units of 0.1°C or °F)<br>Analog input: 0.1% to 999.9% FS (in units of 0.1% FS)   |  |
| <b>Integral time (I)</b>  | 0 to 9999 s (in units of 1 s), 0.0 to 999.9 s (in units of 0.1 s) *4   |  |
| <b>Derivative time (D)</b>  | 0 to 9999 s (in units of 1 s), 0.0 to 999.9 s (in units of 0.1 s) *4   |  |
| <b>Proportional band (P) for cooling</b>  | Temperature input: 0.1 to 999.9°C or °F (in units of 0.1°C or °F)<br>Analog input: 0.1% to 999.9% FS (in units of 0.1% FS)   |  |
| <b>Integral time (I) for cooling</b>  | 0 to 9999 s (in units of 1 s), 0.0 to 999.9 s (in units of 0.1 s) *4   |  |
| <b>Derivative time (D) for cooling</b>  | 0 to 9999 s (in units of 1 s), 0.0 to 999.9 s (in units of 0.1 s) *4   |  |
| <b>Control period</b>   | 0.1, 0.2, 0.5, 1 to 99 s (in units of 1 s)   |  |
| <b>Manual reset value</b>   | 0.0% to 100.0% (in units of 0.1%)  |  |
| <b>Alarm setting range</b>  | -1,999 to 9,999 (decimal point position depends on input type)   |  |
| <b>Influence of signal source resistance</b>  | Thermocouple: 0.1°C/Ω max. (100 Ω max.), Platinum resistance thermometer: 0.1°C/Ω max. (10 Ω max.)   |  |
| <b>Insulation resistance</b>  | 20 MΩ min. (at 500 VDC)  |  |
| <b>Dielectric strength</b>  | 2,300 VAC, 50/60 Hz for 1 min between terminals of different charge  |  |
| <b>Vibration</b>  | <b>Malfunction</b>   | 10 to 55 Hz, 20 m/s <sup>2</sup> for 10 min each in X, Y and Z directions                |
|   | <b>Resistance</b>  | 10 to 55 Hz, 20 m/s <sup>2</sup> for 2 hr each in X, Y, and Z directions                 |
| <b>Shock</b>  | <b>Malfunction</b>   | 100 m/s <sup>2</sup> , 3 times each in X, Y, and Z directions                            |
|   | <b>Resistance</b>  | 300 m/s <sup>2</sup> , 3 times each in X, Y, and Z directions                            |
| <b>Weight</b>   | Controller: Approx. 120 g  |  |
| <b>Degree of protection</b>   | Main unit: IP20, Terminal unit: IP00   |  |
| <b>Memory protection</b>  | Non-volatile memory (number of writes: 1,000,000 times)  |  |
| <b>Setup Tool</b>   | CX-Thermo version 4.6 or higher  |  |
| <b>Setup Tool port</b>  | E5DC bottom panel: An E58-CIFQ2 USB-Serial Conversion Cable is used to connect a USB port on the computer. *5<br>E5DC front panel: An E58-CIFQ2 USB-Serial Conversion Cable and E58-CIFQ2-E Conversion Cable are used together to connect a USB port on the computer.*5  |  |
| <b>Standards</b>  | <b>Approved standards</b>  | UL 61010-1, CSA C22.2 No. 611010-1 (evaluated by UL), Korean Radio Waves Act (Act 10564) |
|   | <b>Conformed standards</b>   | EN 61010-1 (IEC 61010-1): Pollution level 2, overcurrent category II                     |
| <b>EMC</b>  | EMI:<br>Radiated Interference Electromagnetic Field Strength: EN61326<br>Noise Terminal Voltage: EN55011 Group 1, class A<br>EMS:<br>ESD Immunity: EN61326<br>Electromagnetic Field Immunity: EN61000-4-2<br>Burst Noise Immunity: EN61000-4-4<br>Conduction Disturbance Immunity: EN61000-4-6<br>Surge Immunity: EN61000-4-5<br>Voltage Dip/Interrupting Immunity: EN61000-4-11 |  |

\*1 The indication accuracy of K thermocouples in the -200 to 1,300°C range, T and N thermocouples at a temperature of -100°C or less, and U and L thermocouples at any temperature is ±2°C ±1 digit max. The indication accuracy of B thermocouples at a temperature of 400°C max. is not specified. The indication accuracy of B thermocouples at a temperature of 400 to 800°C is ±3°C max.

The indication accuracy of R and S thermocouples at a temperature of 200°C max. is ±3°C ±1 digit max. The indication accuracy of W thermocouples is (±0.3% of PV or ±3°C, whichever is greater) ±1 digit max.

The indication accuracy of PLII thermocouples is (±0.3% of PV or ±2°C, whichever is greater) ±1 digit max.

\*2 Ambient temperature: -10 to 23 to 55°C, Voltage range: -15% to 10% of rated voltage

\*3 K thermocouple at -100°C max: ±10°C max.

\*4 The unit is determined by the setting of the Integral/Derivative Time Unit parameter.

\*5 External serial communications (RS-485) and USB-Serial Conversion Cable communications can be used at the same time.

## USB-Serial Conversion Cable Specifications

|                               |  |
|-------------------------------|--|
| Applicable OS                 | Windows 2000, XP, Vista, or 7  |
| Applicable software           | CX-Thermo version 4.6 or higher  |
| Applicable models             | E5□C Series and E5CB Series  |
| USB interface standard        | Conforms to USB Specification 2.0  |
| DTE speed                     | 38,400 bps   |
| Connector specifications      | Computer: USB (Type A plug)<br>Digital Temperature Controller: Special serial connector        |
| Power supply                  | Bus power (supplied from the USB host controller) *  |
| Power supply voltage          | 5 VDC  |
| Current consumption           | 450 mA max.  |
| Output voltage                | 4.7±0.2 VDC (Supplied from USB-Serial Conversion Cable to the Digital Temperature Controller.) |
| Output current                | 250 mA max. (Supplied from USB-Serial Conversion Cable to the Digital Temperature Controller.) |
| Ambient operating temperature | 0 to 55°C (with no condensation or icing)  |
| Ambient operating humidity    | 10% to 80%   |
| Storage temperature           | -20 to 60°C (with no condensation or icing)  |
| Storage humidity              | 10% to 80%   |
| Altitude                      | 2,000 m max.   |
| Weight                        | Approx. 120 g  |

Windows is a registered trademark of Microsoft Corporation in the United States and other countries.

\* Use a high-power port for the USB port.

**Note:** A driver must be installed on the computer. Refer to the *Instruction Manual* included with the Cable for the installation procedure.

## Communications Specifications

|                                     |   |
|-------------------------------------|---|
| Transmission line connection method | RS-485: Multidrop   |
| Communications                      | RS-485 (two-wire, half-duplex)  |
| Synchronization method              | Start-stop synchronization  |
| Protocol                            | CompoWay/F or Modbus  |
| Baud rate                           | 9,600, 19,200, 38,400, or 57,600 bps  |
| Transmission code                   | ASCII   |
| Data bit length *                   | 7 or 8 bits   |
| Stop bit length *                   | 1 or 2 bits   |
| Error detection                     | Vertical parity (none, even, or odd)<br>Block check character (BCC) with CompoWay/F or CRC-16 with Modbus |
| Flow control                        | None  |
| Interface                           | RS-485  |
| Retry function                      | None  |
| Communications buffer               | 217 bytes   |
| Communications response wait time   | 0 to 99 ms<br>Default: 20 ms  |

\* The baud rate, data bit length, stop bit length, and vertical parity can be individually set using the Communications Setting Level.

## Communications Functions

|  |   |
|--|---|
| <b>Programless communications *</b>        | You can use the memory in the PLC to read and write E5□C parameters, start and stop operation, etc. The E5□C automatically performs communications with the PLC. No communications programming is required.<br>Number of connected Digital Temperature Controllers: 32 max.<br>Applicable PLCs: OMRON PLCs<br>SYSMAC CS Series, CJ Series, or CP Series<br>Mitsubishi Electric PLCs<br>MELSEC Q Series or L Series  |
| <b>Communications between components *</b> | When Digital Temperature Controllers are connected, the parameters can be copied from the Digital Temperature Controller that is set as the master to the Digital Temperature Controllers that are set as slaves.<br>Number of connected Digital Temperature Controllers: 32 max. (including master)<br><br>When Digital Temperature Controllers are connected, set points and RUN/STOP commands can be sent from the Digital Temperature Controller that is set as the master to the Digital Temperature Controllers that are set as slaves.<br>Slope and offsets can be set for the set point.<br>Number of connected Digital Temperature Controllers: 32 max. (including master) |

MELSEC is a registered trademark of Mitsubishi Electric Corporation.

\* A Digital Temperature Controller with version 1.0 or higher is required.

## Current Transformer (Order Separately) Ratings

|                            |   |
|----------------------------|---|
| Dielectric strength        | 1,000 VAC for 1 min                               |
| Vibration resistance       | 50 Hz, 98 m/s <sup>2</sup>                        |
| Weight                     | E54-CT1: Approx. 11.5 g,<br>E54-CT3: Approx. 50 g |
| Accessories (E54-CT3 only) | Armatures (2)<br>Plugs (2)                        |

## Heater Burnout Alarms and SSR Failure Alarms

|   |  |
|---|--|
| CT input (for heater current detection) | Models with detection for single-phase heaters: 1 input                    |
| Maximum heater current                  | 50 A AC  |
| Input current indication accuracy       | ±5% FS ±1 digit max.   |
| Heater burnout alarm setting range *1   | 0.1 to 49.9 A (in units of 0.1 A)<br>Minimum detection ON time: 100 ms *3  |
| SSR failure alarm setting range *2      | 0.1 to 49.9 A (in units of 0.1 A)<br>Minimum detection OFF time: 100 ms *4 |

- \*1 For heater burnout alarms, the heater current will be measured when the control output is ON, and the output will turn ON if the heater current is lower than the set value (i.e., heater burnout detection current value).
- \*2 For SSR failure alarms, the heater current will be measured when the control output is OFF, and the output will turn ON if the heater current is higher than the set value (i.e., SSR failure detection current value).
- \*3 The value is 30 ms for a control period of 0.1 s or 0.2 s.
- \*4 The value is 35 ms for a control period of 0.1 s or 0.2 s.

## Electrical Life Expectancy Curve for Control Output Relay (Reference Values)





# External Connections

## E5DC



- Note:**
1. The application of the terminals depends on the model.
  2. Do not wire the terminals that are shown with a gray background.
  3. When complying with EMC standards, the cable that connects the sensor must be 30 m or less. If the cable length exceeds 30m, compliance with EMC standards will not be possible.
  4. Connect M3 crimped terminals.

## Isolation/Insulation Block Diagrams



- Reinforced insulation
- Functional isolation

**Note:** Auxiliary outputs 1 to 2 are not insulated.

# E5DC

## Nomenclature

### E5DC



## Dimensions

(Unit: mm)

## Controllers

### E5DC



The Setup Tool port is on the bottom of the Temperature Controller. It is used to connect the Temperature Controller to the computer to use the Setup Tool. The E58-CIFQ2 USB-Serial Conversion Cable is required to make the connection. Refer to the instructions that are provided with the USB-Serial Conversion Cable for the connection procedure.

**Note:** Do not leave the USB-Serial Conversion Cable connected when you use the Digital Temperature Controller.



- Recommended panel thickness is 1 to 8 mm.
- Group mounting is not possible in the vertical direction. (Maintain the specified mounting space between Controllers.)
- When two or more Digital Temperature Controllers are mounted, make sure that the surrounding temperature does not exceed the allowable operating temperature specified in the specifications.
- To attach the USB-Serial Conversion Cable to the control panel, use a panel thickness of 1 to 2.5 mm.

## Accessories (Order Separately)

### ● USB-Serial Conversion Cable E58-CIFQ2



### ● Conversion Cable E58-CIFQ2-E

Conversion Cable



Connecting to the E58-CIFQ2 USB-Serial Conversion Cable



**Note:** Always use this product together with the E58-CIFQ2.

E58-CIFQ2 (sold separately)

Conversion Cable

### ● Current Transformers

#### E54-CT1



#### Thru-current (Io) vs. Output Voltage (Eo) (Reference Values)

##### E54-CT1

Maximum continuous heater current: 50 A (50/60 Hz)

Number of windings: 400±2

Winding resistance: 18±2 Ω



#### E54-CT3



#### Thru-current (Io) vs. Output Voltage (Eo) (Reference Values)

##### E54-CT3

Maximum continuous heater current: 120 A (50/60 Hz) (Maximum continuous heater current for an OMRON Digital Temperature Controller is 50 A.)

Number of windings: 400±2

Winding resistance: 8±0.8 Ω



#### E54-CT3 Accessories

##### • Armature



##### Connection Example



##### • Plug



**● Mounting Adapters**  
**Y92F-53 (Two included.)**

This accessory is not included with the product. Order it separately to mount the product to a panel.



**● Short Bars**  
**Y92S-P11 (Four included.)**

Use this product to connect between terminals (for power supplies, communications, etc.) when you use multiple E5DC Controllers.



**● End Plate**  
**PFP-M**

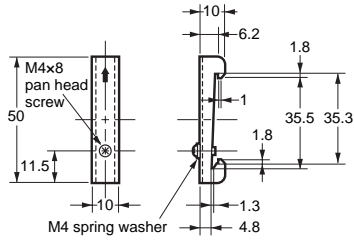

**● DIN Tracks**  
**PFP-100N**  
**PFP-50N**

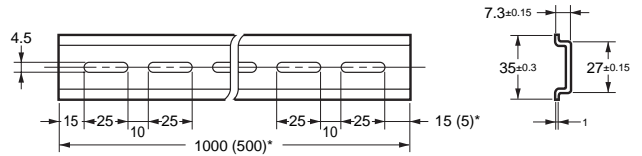
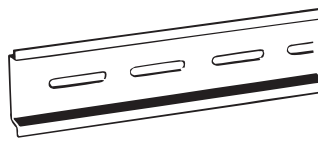

\* Dimensions in parentheses are for the PFP-50N.

**● Spacer**  
**PFP-S**

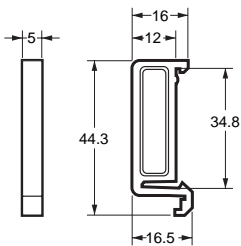

**● Unit Labels**  
**Y92S-L2**

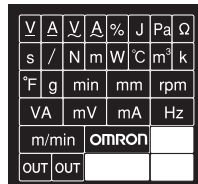

The Unit Labels for the Digital Panel Meter are used. Use either the °C or °F label from the sheet.



Operation

Setting Levels Diagram

This diagram shows all of the setting levels. To move to the advanced function setting level and calibration level, you must enter passwords. Some parameters are not displayed depending on the protect level setting and the conditions of use. Control stops when you move from the operation level to the initial setting level.



\*1. To use a key procedure to move to Manual Control Level, set the Auto/Manual Select Addition parameter to ON and set the PF Setting parameter to a-m (Auto/Manual).  
 \*2. The No. 1 display will flash in the middle when the keys are pressed for 1 s or longer.

## Error Displays (Troubleshooting)

When an error occurs, the No. 1 display or No. 2 display shows the error code.  
Take necessary measure according to the error code, referring the following table.

| Display                              | Name  | Meaning   | Action  | Operation  |
|--------------------------------------|---|---|---|--|
| <i>S.ERR</i>                         | Input error   | The input value exceeded the control range.*<br>The input type is not set correctly.<br>The sensor is disconnected or short-circuited.<br>The sensor is not wired correctly.<br>The sensor is not wired.<br><br>* Control Range<br>Temperature resistance thermometer or thermocouple input:<br>SP Lower Limit - 20°C to SP Upper Limit + 20°C<br>(SP Lower Limit - 40°F to SP Upper Limit + 40°F)<br>ESIB input:<br>Same as specified input range.<br>Analog input:<br>Scaling range -5% to 105% | Check the wiring for input to be sure it is wired correctly, not broken, and not shorted. Also check the input type.<br>If there are no problems in the wiring or input type settings, cycle the power supply.<br>If the display remains the same, replace the Digital Temperature Controller.<br>If the display is restored to normal, then the probable cause is external noise affecting the control system. Check for external noise.<br><br><b>Note:</b> For a temperature resistance thermometer, the input is considered disconnected if the A, B, or B' line is broken. | After the error occurs and it is displayed, the alarm output will operate as if the upper limit was exceeded.<br>It will also operate as if transfer output exceeded the upper limit.<br>If an input error is assigned to a control output or auxiliary output, the output will turn ON when the input error occurs.<br>The error message will appear in the display for the PV.<br><br><b>Note:</b> 1. The heating and cooling control outputs will turn OFF.<br>2. When the manual MV, MV at stop, or MV at error is set, the control output is determined by the set value. |
| <i>CCCC</i>                          | Display range exceeded  | Below -1,999  | This is not an error. It is displayed when the control range is wider than the display range and the PV exceeds the display range. The PV is displayed for the range that is given on the left (the number without the decimal point).  | -  |
| <i>KKKK</i>                          |   | Above 9,999   |   |  |
| <i>E333</i>                          | A/D converter error   | There is an error in the internal circuits.   | First, cycle the power supply. If the display remains the same, the controller must be repaired. If the display is restored to normal, then a probable cause can be external noise affecting the control system. Check for external noise.  | The control outputs, auxiliary outputs, and transfer outputs turn OFF. (A current output will be approx. 0 mA and a linear voltage output will be approx. 0V.)   |
| <i>E111</i>                          | Memory error  | There is an error in the internal memory operation.   | First, cycle the power supply. If the display remains the same, the controller must be repaired. If the display is restored to normal, then a probable cause can be external noise affecting the control system. Check for external noise.  | The control outputs, auxiliary outputs, and transfer outputs turn OFF. (A current output will be approx. 0 mA and a linear voltage output will be approx. 0V.)   |
| <i>FFFF</i>                          | Overcurrent   | This error is displayed when the peak current exceeds 55.0 A.   | -   | Control continues and operation is normal.<br>The error message will appear for the following displays.<br>Heater Current Value 1 Monitor<br>Heater Current Value 2 Monitor<br>Leakage Current Value 1 Monitor<br>Leakage Current Value 2 Monitor  |
| <i>[t1<br/>[t2<br/>LcR1<br/>LcR2</i> | HB or HS alarm  | If there is a HB or HS alarm, the No. 1 display will flash in the relevant setting level.   | -   | The No. 1 display for the following parameter flashes in Operation Level or Adjustment Level.<br>Heater Current Value 1 Monitor<br>Heater Current Value 2 Monitor<br>Leakage Current Value 1 Monitor<br>Leakage Current Value 2 Monitor<br>However, control continues and operation is normal.   |
| <i>----</i>                          | Potentiometer Input Error (Position-proportional Models Only) | "----" will be displayed for the Valve Opening Monitor parameter if any of the following error occurs.<br>• Motor calibration has not been performed.<br>• The wiring of the potentiometer is incorrect or broken.<br>• The potentiometer input value is incorrect (e.g., the input is out of range or the potentiometer has failed).   | Check for the above errors.   | Close control: The control output is OFF or the value that is set for the MV at PV Error parameter is output.<br>Floating control: Operation will be normal.   |

## Operation

### Parameters

The related setting items in each level are described below. If you press the Mode Key at the last setting item, the display will return to the first setting item in the same level.



\*1. When the PF Setting parameter is set to A-M.  
 \*2. When the PF Setting parameter is set to PFDP.  
 \*3. Used with component communications.  
 \*4. Not displayed by the E5DC.





## Safety Precautions

- Be sure to read the precautions for all E5CC/E5EC/E5AC/E5DC models in the website at: <http://www.ia.omron.com/>.

### Warning Indications

|  |   |
|--|---|
|  <b>CAUTION</b> | Indicates a potentially hazardous situation which, if not avoided, may result in minor or moderate injury or in property damage.              |
| <b>Precautions for Safe Use</b>  | Supplementary comments on what to do or avoid doing, to use the product safely.   |
| <b>Precautions for Correct Use</b>   | Supplementary comments on what to do or avoid doing, to prevent failure to operate, malfunction or undesirable effect on product performance. |

### Meaning of Product Safety Symbols

|   |   |
|---|---|
|    | Used to warn of the risk of electric shock under specific conditions.   |
|    | Used for general prohibitions for which there is no specific symbol.  |
|   | Used to indicate prohibition when there is a risk of minor injury from electrical shock or other source if the product is disassembled.   |
|  | Used for general CAUTION, WARNING, or DANGER precautions for which there is no specified symbol. (This symbol is also used as the alerting symbol, but shall not be used in this meaning on the product.) |
|  | Used for general mandatory action precautions for which there is no specified symbol.   |

### CAUTION

Do not touch the terminals while power is being supplied. Doing so may occasionally result in minor injury due to electric shock. 

Electric shock may occur. Do not touch any cables or connectors with wet hands. 

Electric shock, fire, or malfunction may occasionally occur. Do not allow metal objects, conductors, cuttings from installation work, or moisture to enter the Digital Temperature Controller or the Setup Tool port or ports. Attach the cover to the front-panel Setup Tool port whenever you are not using it to prevent foreign objects from entering the port. 

Do not use the Digital Temperature Controller where subject to flammable or explosive gas. Otherwise, minor injury from explosion may occasionally occur. 

Not doing so may occasionally result in fire. Do not allow dirt or other foreign objects to enter the Setup Tool port or ports, or between the pins on the connectors on the Setup Tool cable. 

Minor electric shock or fire may occasionally occur. Do not use any cables that are damaged. 

Never disassemble, modify, or repair the product or touch any of the internal parts. Minor electric shock, fire, or malfunction may occasionally occur. 

**CAUTION - Risk of Fire and Electric Shock**

- a. This product is UL recognised as Open Type Process Control Equipment. It must be mounted in an enclosure that does not allow fire to escape externally. 
- b. More than one disconnect switch may be required to de-energize the equipment before servicing the product.
- c. Signal inputs are SELV, limited energy. \*1
- d. Caution: To reduce the risk of fire or electric shock, do not interconnect the outputs of different Class 2 circuits. \*2

If the output relays are used past their life expectancy, contact fusing or burning may occasionally occur. Always consider the application conditions and use the output relays within their rated load and electrical life expectancy. The life expectancy of output relays varies considerably with the output load and switching conditions. 

Even if you replace only the Main Unit of the E5DC, check the condition of the Terminal Unit. If corroded terminals are used, contact failure in the terminals may cause the temperature inside the Digital Controller to increase, possibly resulting in fire. If the terminals are corroded, replace the Terminal Unit as well. 

Tighten the terminal screws to the rated torque of between 0.43 and 0.58 N·m. Loose screws may occasionally result in fire. 

Set the parameters of the product so that they are suitable for the system being controlled. If they are not suitable, unexpected operation may occasionally result in property damage or accidents. 

A malfunction in the product may occasionally make control operations impossible or prevent alarm outputs, resulting in property damage. To maintain safety in the event of malfunction of the product, take appropriate safety measures, such as installing a monitoring device on a separate line. 

\*1. An SELV (separated extra-low voltage) system is one with a power supply that has double or reinforced insulation between the primary and the secondary circuits and has an output voltage of 30 V r.m.s. max. and 42.4 V peak max. or 60 VDC max.  
\*2. A class 2 circuit is one tested and certified by UL as having the current and voltage of the secondary output restricted to specific levels.

## Precautions for Safe Use

Be sure to observe the following precautions to prevent malfunction or adverse affects on the performance or functionality of the product. Not doing so may occasionally result in faulty operation.

1. This product is specifically designed for indoor use only.
  - Do not use this product in the following places:
    - Places directly subject to heat radiated from heating equipment.
    - Places subject to splashing liquid or oil atmosphere.
    - Places subject to direct sunlight.
    - Places subject to dust or corrosive gas (in particular, sulfide gas and ammonia gas).
    - Places subject to intense temperature change.
    - Places subject to icing and condensation.
    - Places subject to vibration and large shocks.
2. Use and store the product within the rated ambient temperature and humidity.
 

Gang-mounting two or more Digital Temperature Controllers, or mounting Digital Temperature Controllers above each other may cause heat to build up inside the Digital Temperature Controllers, which will shorten their service life. In such a case, use forced cooling by fans or other means of air ventilation to cool down the Digital Temperature Controllers.
3. To allow heat to escape, do not block the area around the Digital Temperature Controller.
 

Do not block the ventilation holes on the Digital Temperature Controller.
4. Be sure to wire properly with correct polarity of terminals.
5. Use the specified size of crimp terminals for wiring (M3, width of 5.8 mm or less). For open-wired connections, use stranded or solid copper wires with a gauge of AWG24 to AWG18 (equal to a cross-sectional area of 0.205 to 0.823 mm<sup>2</sup>). (The stripping length is 6 to 8 mm.) Up to two wires of the same size and type or two crimp terminals can be connected to one terminal. Do not connect more than two wires or more than two crimp terminals to the same terminal.
6. Do not wire the terminals that are not used.
7. Use a commercial power supply for the power supply voltage input to a Digital Temperature Controller with AC input specifications. Do not use the output from an inverter as the power supply. Depending on the output characteristics of the inverter, temperature increases in the Digital Temperature Controller may cause smoke or fire damage even if the inverter has a specified output frequency of 50/60 Hz.
8. To avoid inductive noise, keep the wiring for the product's terminal block away from power cables carry high voltages or large currents. Also, do not wire power lines together with or parallel to product wiring. Using shielded cables and using separate conduits or ducts is recommended.
 

Attach a surge suppressor or noise filter to peripheral devices that generate noise (in particular, motors, transformers, solenoids, magnetic coils, or other equipment that have an inductance component).

When a noise filter is used at the power supply, first check the voltage or current, and attach the noise filter as close as possible to the product.

Allow as much space as possible between the product and devices that generate powerful high frequencies (high-frequency welders, high-frequency sewing machines, etc.) or surge.
9. Use this product within the rated load and power supply.
10. Make sure that the rated voltage is attained within two seconds of turning ON the power using a switch or relay contact. If the voltage is applied gradually, the power may not be reset or output malfunctions may occur.
11. Make sure that the Digital Temperature Controller has 30 minutes or more to warm up after turning ON the power before starting actual control operations to ensure the correct temperature display.
12. When executing self-tuning, turn ON power to the load (e.g., heater) at the same time as or before supplying power to the product. If power is turned ON to the product before turning ON power to the load, self-tuning will not be performed properly and optimum control will not be achieved.
13. A switch or circuit breaker must be provided close to the product. The switch or circuit breaker must be within easy reach of the operator, and must be marked as a disconnecting means for this unit.
14. Use a soft and dry cloth to clean the product carefully. Do not use organic solvent, such as paint thinner, benzine or alcohol to clean the product.
15. Design the system (e.g., control panel) considering the 2 seconds of delay that the product's output to be set after power ON.
16. The output may turn OFF when you move to the initial setting level. Take this into consideration when performing control operations.
17. The number of non-volatile memory write operations is limited. Therefore, use RAM write mode when frequently overwriting data during communications or other operations.
18. Use suitable tools when taking the Digital Temperature Temperature Controller apart for disposal. Sharp parts inside the Digital Temperature Controller may cause injury.
19. Do not connect cables to both the front Setup Tool port and the top-panel or bottom-panel Setup Tool port at the same time. The Digital Controller may be damaged or may malfunction.
20. Do not place heavy object on the Conversion Cable, bend the cable past its natural bending radius, or pull on the cable with undue force.
21. Do not disconnect the Communications Conversion Cable or the USB-Serial Conversion Cable while communications are in progress. Damage or malfunction may occur.
22. Do not touch the external power supply terminals or other metal parts on the Digital Temperature Controller.
23. Refer to the E5□C Digital Temperature Controllers User's Manual (Cat. No. H174) for information on the communications distances and cables.
24. Do not bend the communications cables past their natural bending radius. Do not pull on the communications cables.
25. Do not turn the power supply to the Digital Temperature Controller ON or OFF while the USB-Serial Conversion Cable is connected. The Digital Temperature Controller may malfunction.
26. Make sure that the indicators on the USB-Serial Conversion Cable are operating properly. Depending on the application conditions, deterioration in the connectors and cable may be accelerated, and normal communications may become impossible. Perform periodic inspection and replacement.
27. Connectors may be damaged if they are inserted with excessive force. When connecting a connector, always make sure that it is oriented correctly. Do not force the connector if it does not connect smoothly.
28. Noise may enter on the USB-Serial Conversion Cable, possibly causing equipment malfunctions. Do not leave the USB-Serial Conversion Cable connected constantly to the equipment.
29. For the E5DC, when you attach the Main Unit to the Terminal Unit, make sure that the hooks on the Main Unit are securely inserted into the Terminal Unit.
30. Install the DIN Track vertically to the ground.
31. For the E5DC, always turn OFF the power supply before connecting the Main Unit to or disconnecting the Main Unit from the Terminal Unit, and never touch nor apply shock to the terminals or electronic components. When connecting or disconnecting the Main Unit, do not allow the electronic components to touch the case.

## Shipping Standards

The E5CC, E5EC, and E5AC comply with Lloyd's standards. When applying the standards, the following installation and wiring requirements must be met in the application.

## Application Conditions

### ● Installation Location

The E5CC, E5EC, and E5AC comply with installation category ENV1 and ENV2 of Lloyd's standards. Therefore, they must be installed in a location equipped with air conditioning. They cannot be used on the bridge or decks, or in a location subject to strong vibration.

## Precautions for Correct Use

### ● Service Life

- Use the product within the following temperature and humidity ranges:  
 Temperature: -10 to 55°C (with no icing or condensation)  
 Humidity: 25% to 85%  
 If the product is installed inside a control board, the ambient temperature must be kept to under 55°C, including the temperature around the product.
- The service life of electronic devices like Digital Temperature Controllers is determined not only by the number of times the relay is switched but also by the service life of internal electronic components. Component service life is affected by the ambient temperature: the higher the temperature, the shorter the service life and, the lower the temperature, the longer the service life. Therefore, the service life can be extended by lowering the temperature of the Digital Temperature Controller.
- When two or more Digital Temperature Controllers are mounted horizontally close to each other or vertically next to one another, the internal temperature will increase due to heat radiated by the Digital Temperature Controllers and the service life will decrease. In such a case, use forced cooling by fans or other means of air ventilation to cool down the Digital Temperature Controllers. When providing forced cooling, however, be careful not to cool down the terminals sections alone to avoid measurement errors.

### ● Measurement Accuracy

- When extending or connecting the thermocouple lead wire, be sure to use compensating wires that match the thermocouple types.
- When extending or connecting the lead wire of the platinum resistance thermometer, be sure to use wires that have low resistance and keep the resistance of the three lead wires the same.
- Mount the product so that it is horizontally level.
- If the measurement accuracy is low, check to see if input shift has been set correctly.

### ● Waterproofing (Not applicable to the E5DC.)

The degree of protection is as shown below. Sections without any specification on their degree of protection or those with IP□0 are not waterproof.

Front panel: IP66, Rear case: IP20, Terminal section: IP00  
 When waterproofing is required, insert the Waterproof Packing on the backside of the front panel. Keep the Port Cover on the front-panel Setup Tool port of the E5EC securely closed. The degree of protection when the Waterproof Packing is used is IP66. To maintain an IP66 degree of protection, the Waterproof Packing and the Port Cover for the front-panel Setup Tool port must be periodically replaced because they may deteriorate, shrink, or harden depending on the operating environment. The replacement period will vary with the operating environment. Check the required period in the actual application. Use 3 years or sooner as a guideline. If the Waterproof Packing and Port Cover are not periodically replaced, waterproof performance may not be maintained. If a waterproof structure is not required, then the Waterproof Packing does not need to be installed.

### ● Operating Precautions

- When starting operation after the Digital Temperature Controller has warmed up, turn OFF the power and then turn it ON again at the same time as turning ON power for the load. (Instead of turning the Digital Temperature Controller OFF and ON again, switching from STOP mode to RUN mode can also be used.)
- Avoid using the Controller in places near a radio, television set, or wireless installing. These devices can cause radio disturbances which adversely affect the performance of the Controller.

### ● Others

- Do not Connect or disconnect the Conversion Cable connector repeatedly over a short period of time.  
The computer may malfunction.
- After connecting the Conversion Cable to the computer, check the COM port number before starting communications. The computer requires time to recognize the cable connection. This delay does not indicate failure.
- Do not connect the Conversion Cable through a USB hub. Doing so may damage the Conversion Cable.
- Do not use an extension cable to extend the Conversion Cable length when connecting to the computer. Doing so may damage the Conversion Cable.

### ● Mounting

#### Mounting to a Panel

#### E5CC

There are two models of Terminal Covers that you can use with the E5CC.



- For waterproof mounting, waterproof packing must be installed on the Controller. Waterproofing is not possible when group mounting several Controllers. Waterproof packing is not necessary when there is no need for the waterproofing function.
- Insert the E5CC into the mounting hole in the panel.
- Push the adapter from the terminals up to the panel, and temporarily fasten the E5CC.
- Tighten the two fastening screws on the adapter. Alternately tighten the two screws little by little to maintain a balance. Tighten the screws to a torque of 0.29 to 0.39 N·m.

## E5EC/E5AC



1. For waterproof mounting, waterproof packing must be installed on the Controller. Waterproofing is not possible when group mounting several Controllers. Waterproof packing is not necessary when there is no need for the waterproofing function.
2. Insert the E5EC/E5AC into the mounting hole in the panel.
3. Push the adapter from the terminals up to the panel, and temporarily fasten the E5EC/E5AC.
4. Tighten the two fastening screws on the adapter. Alternately tighten the two screws little by little to maintain a balance. Tighten the screws to a torque of 0.29 to 0.39 N·m.

## Mounting to and Removing from DIN Track

### E5DC

#### • Mounting a Unit

Pull down the DIN Track hook on the Terminal Unit and catch the top hook on the DIN Track. Press the Unit onto the DIN Track until the DIN Track hooks are locked in place.

2. Catch the top hook on the DIN Track.



#### • Removing a Unit

Pull down on the DIN Track Hook with a flat-blade screwdriver and lift up the Unit.



## Removing the Main Unit

Press in the two hooks on the Main Unit and remove the Main Unit from the Terminal Unit.



## End Plate Installation

Make sure to attach PFP-M End Plates to the ends of the Units.



## Mounting the DIN Track

Attach the DIN Track to the inside of the control panel with screws to at least three locations.

- DIN Track (sold separately)
  - PFP-50N (50 cm) and PFP-100N (100 cm)



Install the DIN Track vertically to the ground.



## Mounting to a Panel

### E5DC



1. Insert the E5DC into the mounting hole in the panel. (Attach the Terminal Unit after you insert the Main Unit.)
2. Push the Adapter from the Terminal Unit up to the panel, and temporarily fasten the E5DC.
3. Tighten the two fastening screws on the Adapter. Alternately tighten the two screws little by little to maintain a balance. Tighten the screws to a torque of 0.29 to 0.39 N·m.

# E5CC/E5EC/E5AC/E5DC

## Mounting the Terminal Cover E5CC

Slightly bend the E53-COV23 Terminal Cover to attach it to the terminal block as shown in the following diagram. The Terminal Cover cannot be attached in the opposite direction. E53-COV17 Terminal Cover can be also attached.

Make sure that the "UP" mark is facing up, and then attach the E53-COV17 Terminal Cover to the holes on the top and bottom of the Digital Temperature Controller.



## ● Precautions when Wiring

- Separate input leads and power lines in order to prevent external noise.
- Use a shielded, AWG24 to AWG18 (cross-sectional area of 0.205 to 0.8231 mm<sup>2</sup>) twisted-pair cable.
- Use crimp terminals when wiring the terminals.
- Use the suitable wiring material and crimp tools for crimp terminals.
- Tighten the terminal screws to a torque of 0.43 to 0.58 N•m.
- Use the following types of crimp terminals for M3 screws.



## E5EC/E5AC

Slightly bend the E53-COV24 Terminal Cover to attach it to the terminal block as shown in the following diagram. The Terminal Cover cannot be attached in the opposite direction.



## Three-year Guarantee

### ● Period of Guarantee

The guarantee period of the Unit is three years starting from the date the Unit is shipped from the factory.

### Scope of Guarantee

The Unit is guaranteed under the following operating conditions.

1. Average Operating Temperature (see note): -10°C to 50°C
2. Mounting Method: Standard mounting



### Note: Average Operating Temperature

Refer to the process temperature of the Unit mounted to a control panel and connected to peripheral devices on condition that the Unit is in stable operation, sensor input type K is selected for the Unit, the positive and negative thermocouple input terminals of the Unit are short-circuited, and the ambient temperature is stable.

Should the Unit malfunction during the guarantee period, OMRON shall repair the Unit or replace any parts of the Unit at the expense of OMRON.

## Read and Understand this Catalog

Please read and understand this catalog before purchasing the product. Please consult your OMRON representative if you have any questions or comments.

## Warranty and Limitations of Liability

### WARRANTY

OMRON's exclusive warranty is that the products are free from defects in materials and workmanship for a period of one year (or other period if specified) from date of sale by OMRON.

OMRON MAKES NO WARRANTY OR REPRESENTATION, EXPRESS OR IMPLIED, REGARDING NON-INFRINGEMENT, MERCHANTABILITY, OR FITNESS FOR PARTICULAR PURPOSE OF THE PRODUCTS. ANY BUYER OR USER ACKNOWLEDGES THAT THE BUYER OR USER ALONE HAS DETERMINED THAT THE PRODUCTS WILL SUITABLY MEET THE REQUIREMENTS OF THEIR INTENDED USE. OMRON DISCLAIMS ALL OTHER WARRANTIES, EXPRESS OR IMPLIED.

### LIMITATIONS OF LIABILITY

OMRON SHALL NOT BE RESPONSIBLE FOR SPECIAL, INDIRECT, OR CONSEQUENTIAL DAMAGES, LOSS OF PROFITS OR COMMERCIAL LOSS IN ANY WAY CONNECTED WITH THE PRODUCTS, WHETHER SUCH CLAIM IS BASED ON CONTRACT, WARRANTY, NEGLIGENCE, OR STRICT LIABILITY.

In no event shall the responsibility of OMRON for any act exceed the individual price of the product on which liability is asserted.

IN NO EVENT SHALL OMRON BE RESPONSIBLE FOR WARRANTY, REPAIR, OR OTHER CLAIMS REGARDING THE PRODUCTS UNLESS OMRON'S ANALYSIS CONFIRMS THAT THE PRODUCTS WERE PROPERLY HANDLED, STORED, INSTALLED, AND MAINTAINED AND NOT SUBJECT TO CONTAMINATION, ABUSE, MISUSE, OR INAPPROPRIATE MODIFICATION OR REPAIR.

## Application Considerations

### SUITABILITY FOR USE

OMRON shall not be responsible for conformity with any standards, codes, or regulations that apply to the combination of the product in the customer's application or use of the product.

Take all necessary steps to determine the suitability of the product for the systems, machines, and equipment with which it will be used.

Know and observe all prohibitions of use applicable to this product.

NEVER USE THE PRODUCT FOR AN APPLICATION INVOLVING SERIOUS RISK TO LIFE OR PROPERTY WITHOUT ENSURING THAT THE SYSTEM AS A WHOLE HAS BEEN DESIGNED TO ADDRESS THE RISKS, AND THAT THE OMRON PRODUCT IS PROPERLY RATED AND INSTALLED FOR THE INTENDED USE WITHIN THE OVERALL EQUIPMENT OR SYSTEM.

### PROGRAMMABLE PRODUCTS

OMRON shall not be responsible for the user's programming of a programmable product, or any consequence thereof.

## Disclaimers

### CHANGE IN SPECIFICATIONS

Product specifications and accessories may be changed at any time based on improvements and other reasons. Consult with your OMRON representative at any time to confirm actual specifications of purchased product.

### DIMENSIONS AND WEIGHTS

Dimensions and weights are nominal and are not to be used for manufacturing purposes, even when tolerances are shown.

### PERFORMANCE DATA

Performance data given in this catalog is provided as a guide for the user in determining suitability and does not constitute a warranty. It may represent the result of OMRON's test conditions, and the users must correlate it to actual application requirements. Actual performance is subject to the OMRON Warranty and Limitations of Liability.

**Note: Do not use this document to operate the Unit.**

**OMRON Corporation Industrial Automation Company**  
Tokyo, JAPAN

Contact: [www.ia.omron.com](http://www.ia.omron.com)

**Regional Headquarters**

**OMRON EUROPE B.V.**

Wegalaan 67-69-2132 JD Hoofddorp  
The Netherlands  
Tel: (31)2356-81-300/Fax: (31)2356-81-388

**OMRON ELECTRONICS LLC**

One Commerce Drive Schaumburg,  
IL 60173-5302 U.S.A.  
Tel: (1) 847-843-7900/Fax: (1) 847-843-7787

**OMRON ASIA PACIFIC PTE. LTD.**

No. 438A Alexandra Road # 05-05/08 (Lobby 2),  
Alexandra Technopark,  
Singapore 119967  
Tel: (65) 6835-3011/Fax: (65) 6835-2711

**OMRON (CHINA) CO., LTD.**

Room 2211, Bank of China Tower,  
200 Yin Cheng Zhong Road,  
PuDong New Area, Shanghai, 200120, China  
Tel: (86) 21-5037-2222/Fax: (86) 21-5037-2200

**Authorized Distributor:**

© OMRON Corporation 2011-2013 All Rights Reserved.  
In the interest of product improvement,  
specifications are subject to change without notice.

CSM\_8\_1\_0713  
Cat. No. H177-E1-04

0613 (1111)



# Mouser Electronics

Authorized Distributor

Click to View Pricing, Inventory, Delivery & Lifecycle Information:

## Omron:

[E5AC-CC4D5M-005](#) [E5AC-CQ4A5M-009](#) [E5AC-CQ4D5M-009](#) [E5AC-CC4A5M-005](#) [E5AC-CC4D5M-004](#) [E5AC-CQ4A5M-000](#) [E5AC-CQ4D5M-000](#) [E5AC-CX1DSM-800](#) [E5AC-CX3DSM-804](#) [E5AC-CX4A5M-013](#) [E5AC-CX4D5M-005](#) [E5AC-PR2ASM-800](#) [E5AC-PR4A5M-014](#) [E5AC-QQ4A5M-000](#) [E5AC-QQ4D5M-000](#) [E5AC-CC4A5M-000](#) [E5AC-CC4A5M-014](#) [E5AC-CC4D5M-013](#) [E5AC-CQ4A5M-010](#) [E5AC-CQ4D5M-010](#) [E5AC-CX3ASM-800](#) [E5AC-CX1ASM-800](#) [E5AC-CX3DSM-800](#) [E5AC-CX4A5M-005](#) [E5AC-CX4D5M-004](#) [E5AC-PR0ASM-800](#) [E5AC-PR4A5M-004](#) [E5AC-CC4A5M-013](#) [Y92A-48H](#) [Y92S-P8](#) [E5AC-PR4D5M-014](#) [E5AC-QQ4A5M-011](#) [E5AC-QQ4D5M-011](#) [E5AC-QR4A5M-011](#) [E5AC-QR4D5M-011](#) [E5AC-QX3ASM-808](#) [E5AC-QX3DSM-810](#) [E5AC-QX4A5M-011](#) [E5AC-QX4D5M-011](#) [E5AC-RR4A5M-011](#) [E5AC-CX3ASM-804](#) [E5AC-CX4A5M-004](#) [E5AC-CX4D5M-000](#) [E5AC-CX4D5M-014](#) [E5AC-PR4A5M-000](#) [E5AC-PR4D5M-004](#) [E5AC-QQ4A5M-010](#) [E5AC-CC4A5M-004](#) [E5AC-CC4D5M-000](#) [E5AC-CC4D5M-014](#) [E5AC-CQ4A5M-011](#) [E5AC-CQ4D5M-011](#) [E5AC-QX1DSM-800](#) [E5AC-QX3DSM-800](#) [E5AC-QX4A5M-009](#) [E5AC-QX4D5M-009](#) [E5AC-RR4A5M-009](#) [E5AC-RR4D5M-010](#) [E5EC-PR4A5M-014](#) [E5AC-QR4A5M-009](#) [E5AC-QR4D5M-009](#) [E5AC-RX1ASM-800](#) [E5AC-RX3ASM-810](#) [E5AC-RX4A5M-000](#) [E5AC-RX4D5M-000](#) [E5EC-CQ4A5M-000](#) [E5EC-CQ4D5M-000](#) [E5EC-PR2ASM-804](#) [E5EC-PR4D5M-000](#) [E5AC-QQ4D5M-010](#) [E5AC-QR4A5M-010](#) [E5AC-QR4D5M-010](#) [E5AC-QX3ASM-800](#) [E5AC-QX3DSM-808](#) [E5AC-QX4A5M-010](#) [E5AC-QX4D5M-010](#) [E5AC-RR4A5M-010](#) [E5AC-CX4A5M-000](#) [E5AC-CX4A5M-014](#) [E5AC-CX4D5M-013](#) [E5AC-PR2ASM-804](#) [E5AC-PR4D5M-000](#) [E5AC-QQ4A5M-009](#) [E5AC-QQ4D5M-009](#) [E5AC-RR4D5M-011](#) [E5AC-RX3ASM-808](#) [E5AC-RX3DSM-810](#) [E5AC-RX4A5M-011](#) [E5AC-RX4D5M-011](#) [E5EC-CQ4A5M-011](#) [E5EC-CQ4D5M-011](#) [E5EC-PR2ASM-800](#) [E5EC-QR4A5M-000](#) [E5EC-QR4D5M-000](#) [E5EC-QX4A5M-000](#) [E5EC-QX4D5M-000](#) [E5EC-RR4A5M-000](#) [E5EC-RR4D5M-000](#) [E5EC-RX4A5M-000](#) [E5EC-RX4D5M-000](#)

## Данный компонент на территории Российской Федерации

### Вы можете приобрести в компании MosChip.

Для оперативного оформления запроса Вам необходимо перейти по данной ссылке:

<http://moschip.ru/get-element>

Вы можете разместить у нас заказ для любого Вашего проекта, будь то серийное производство или разработка единичного прибора.

В нашем ассортименте представлены ведущие мировые производители активных и пассивных электронных компонентов.

Нашей специализацией является поставка электронной компонентной базы двойного назначения, продукции таких производителей как XILINX, Intel (ex.ALTERA), Vicor, Microchip, Texas Instruments, Analog Devices, Mini-Circuits, Amphenol, Glenair.

Сотрудничество с глобальными дистрибьюторами электронных компонентов, предоставляет возможность заказывать и получать с международных складов практически любой перечень компонентов в оптимальные для Вас сроки.

На всех этапах разработки и производства наши партнеры могут получить квалифицированную поддержку опытных инженеров.

Система менеджмента качества компании отвечает требованиям в соответствии с ГОСТ Р ИСО 9001, ГОСТ РВ 0015-002 и ЭС РД 009

### Офис по работе с юридическими лицами:

105318, г.Москва, ул.Щербаковская д.3, офис 1107, 1118, ДЦ «Щербаковский»

Телефон: +7 495 668-12-70 (многоканальный)

Факс: +7 495 668-12-70 (доб.304)

E-mail: [info@moschip.ru](mailto:info@moschip.ru)

Skype отдела продаж:

moschip.ru

moschip.ru\_4

moschip.ru\_6

moschip.ru\_9