



## Features

- Axial leaded
- Fully compatible with current industry standards
- Weldable nickel terminals
- Very low internal resistance
- Agency recognition:   
- RoHS compliant\*

## Applications

- Rechargeable battery pack protection
- Provides overcurrent protection with 125 °C trip temperature

## MF-S Series - PTC Resettable Fuses

### Electrical Characteristics

Model	V max. Volts	I max. Amps	I <sub>hold</sub>	I <sub>trip</sub>	Initial Resistance		1 Hour (R <sub>1</sub> ) Post-Trip Resistance	Max. Time to Trip		Tripped Power Dissipation
			Amperes at 23 °C		Ohms at 23 °C		Ohms at 23 °C	Amperes at 23 °C	Seconds at 23 °C	Watts at 23 °C
			Hold	Trip	Min.	Max.	Max.			Typ.
MF-S120	15	100	1.20	2.70	0.085	0.160	0.220	6	5.0	1.20
MF-S120S	15	100	1.20	2.70	0.085	0.160	0.220	6	5.0	1.20
MF-S150	15	100	1.50	3.00	0.050	0.090	0.113	8	5.0	1.30
MF-S175	15	100	1.75	3.80	0.050	0.090	0.120	9	4.0	1.50
MF-S175S	15	100	1.75	3.80	0.050	0.090	0.120	9	4.0	1.50
MF-S200	30	100	2.00	4.40	0.030	0.060	0.080	10	4.0	1.90
MF-S350	30	100	3.50	6.30	0.017	0.031	0.040	20	3.0	2.50
MF-S420	30	100	4.20	7.60	0.012	0.024	0.040	20	6.0	2.90

NOTE: Slotted lead option available on all models.

### Environmental Characteristics

Operating/Storage Temperature.....	-40 °C to +85 °C
Maximum Device Surface Temperature in Tripped State .....	125 °C
Passive Aging.....	+85 °C, 1000 hours..... ±5 % typical resistance change
Humidity Aging.....	+85 °C, 85% R.H. 7 days..... ±5 % typical resistance change
Vibration .....	MIL-STD-883C, Method 2007.1,..... No change Condition A

### Test Procedures And Requirements For Model MF-S Series

Test	Test Conditions	Accept/Reject Criteria
Visual/Mech.....	Verify dimensions and materials.....	Per MF physical description
Resistance.....	In still air @ 23 °C.....	R <sub>min</sub> ≤ R ≤ R <sub>1max</sub>
Time to Trip.....	At specified current, V <sub>max</sub> , 23 °C.....	T ≤ max. time to trip (seconds)
Hold Current.....	30 min. at I <sub>hold</sub> .....	No trip
Trip Cycle Life.....	V <sub>max</sub> , I <sub>max</sub> , 100 cycles.....	No arcing or burning
Trip Endurance.....	V <sub>max</sub> , 48 hours.....	No arcing or burning

UL File Number .....	E 174545S
CSA File Number.....	CA 110338
TÜV File Number .....	R2057213

### Thermal Derating Chart - I<sub>hold</sub> / I<sub>trip</sub> (Amps)

Model	Ambient Operating Temperature								
	-40 °C	-20 °C	0 °C	23 °C	40 °C	50 °C	60 °C	70 °C	85 °C
MF-S120	1.90 / 4.28	1.70 / 3.83	1.50 / 3.38	1.20 / 2.70	1.00 / 2.25	0.90 / 2.03	0.80 / 1.80	0.70 / 1.58	0.50 / 1.13
MF-S120S	1.90 / 4.28	1.70 / 3.83	1.50 / 3.38	1.20 / 2.70	1.00 / 2.25	0.90 / 2.03	0.80 / 1.80	0.70 / 1.58	0.50 / 1.13
MF-S150	2.20 / 4.40	2.00 / 4.00	1.80 / 3.60	1.50 / 3.00	1.30 / 2.60	1.10 / 2.20	1.00 / 2.00	0.90 / 1.80	0.70 / 1.40
MF-S175	2.50 / 5.59	2.30 / 5.14	2.00 / 4.47	1.70 / 3.80	1.50 / 3.35	1.30 / 2.91	1.20 / 2.68	1.10 / 2.46	0.90 / 2.01
MF-S175S	2.50 / 5.59	2.30 / 5.14	2.00 / 4.47	1.70 / 3.80	1.50 / 3.35	1.30 / 2.91	1.20 / 2.68	1.10 / 2.46	0.90 / 2.01
MF-S200	3.20 / 7.04	2.80 / 6.16	2.50 / 5.50	2.00 / 4.40	1.70 / 3.74	1.60 / 3.52	1.40 / 3.08	1.20 / 2.64	0.90 / 1.98
MF-S350	5.40 / 9.72	4.80 / 8.64	4.30 / 7.74	3.50 / 6.30	3.00 / 5.40	2.80 / 5.04	2.50 / 4.50	2.20 / 3.96	1.70 / 3.06
MF-S420	6.40 / 11.5	5.70 / 10.3	5.10 / 9.23	4.20 / 7.60	3.60 / 6.51	3.30 / 5.97	3.00 / 5.43	2.60 / 4.70	2.10 / 3.80

\*RoHS Directive 2002/95/EC Jan 27, 2003 including Annex.

Specifications are subject to change without notice.

Customers should verify actual device performance in their specific applications.

# MF-S Series - PTC Resettable Fuses

**BOURNS®**

## Product Dimensions

Model	A		B		C		D		F	
	Min.	Max.	Min.	Max.	Min.	Max.	Min.	Max.	Min.	Max.
MF-S120	$\frac{19.9}{(0.783)}$	$\frac{22.1}{(0.870)}$	$\frac{4.9}{(0.193)}$	$\frac{5.2}{(0.205)}$	$\frac{0.6}{(0.024)}$	$\frac{1.0}{(0.039)}$	$\frac{5.5}{(0.217)}$	$\frac{7.5}{(0.295)}$	$\frac{3.8}{(0.150)}$	$\frac{4.1}{(0.161)}$
MF-S120S	$\frac{19.9}{(0.783)}$	$\frac{22.1}{(0.870)}$	$\frac{4.9}{(0.193)}$	$\frac{5.2}{(0.205)}$	$\frac{0.6}{(0.024)}$	$\frac{1.0}{(0.039)}$	$\frac{5.5}{(0.217)}$	$\frac{7.5}{(0.295)}$	$\frac{3.8}{(0.150)}$	$\frac{4.1}{(0.161)}$
MF-S150	$\frac{21.3}{(0.839)}$	$\frac{23.4}{(0.921)}$	$\frac{10.2}{(0.402)}$	$\frac{11.0}{(0.433)}$	$\frac{0.5}{(0.020)}$	$\frac{1.1}{(0.043)}$	$\frac{4.1}{(0.161)}$	$\frac{5.5}{(0.217)}$	$\frac{4.8}{(0.189)}$	$\frac{5.4}{(0.213)}$
MF-S175	$\frac{20.9}{(0.823)}$	$\frac{23.1}{(0.909)}$	$\frac{4.9}{(0.193)}$	$\frac{5.2}{(0.205)}$	$\frac{0.6}{(0.024)}$	$\frac{1.0}{(0.039)}$	$\frac{4.1}{(0.161)}$	$\frac{5.5}{(0.217)}$	$\frac{3.8}{(0.150)}$	$\frac{4.1}{(0.161)}$
MF-S175S	$\frac{20.9}{(0.823)}$	$\frac{23.1}{(0.909)}$	$\frac{4.9}{(0.193)}$	$\frac{5.2}{(0.205)}$	$\frac{0.6}{(0.024)}$	$\frac{1.0}{(0.039)}$	$\frac{4.1}{(0.161)}$	$\frac{5.5}{(0.217)}$	$\frac{3.8}{(0.150)}$	$\frac{4.1}{(0.161)}$
MF-S200	$\frac{21.3}{(0.839)}$	$\frac{23.4}{(0.921)}$	$\frac{10.2}{(0.402)}$	$\frac{11.0}{(0.433)}$	$\frac{0.5}{(0.020)}$	$\frac{1.1}{(0.043)}$	$\frac{5.0}{(0.197)}$	$\frac{7.6}{(0.299)}$	$\frac{4.8}{(0.189)}$	$\frac{5.4}{(0.213)}$
MF-S350	$\frac{28.4}{(1.119)}$	$\frac{31.8}{(1.252)}$	$\frac{13.0}{(0.512)}$	$\frac{13.5}{(0.531)}$	$\frac{0.5}{(0.020)}$	$\frac{1.1}{(0.043)}$	$\frac{6.3}{(0.248)}$	$\frac{8.9}{(0.350)}$	$\frac{6.0}{(0.236)}$	$\frac{6.6}{(0.260)}$
MF-S420	$\frac{30.6}{(1.205)}$	$\frac{32.4}{(1.276)}$	$\frac{12.9}{(0.508)}$	$\frac{13.6}{(0.535)}$	$\frac{0.5}{(0.020)}$	$\frac{1.1}{(0.043)}$	$\frac{5.0}{(0.197)}$	$\frac{7.5}{(0.295)}$	$\frac{6.0}{(0.236)}$	$\frac{6.6}{(0.260)}$

Packaging: Bulk - 500 pcs. per bag.  
Tape and Reel - Consult factory.

DIMENSIONS:  $\frac{\text{MM}}{\text{(INCHES)}}$

### Standard Style

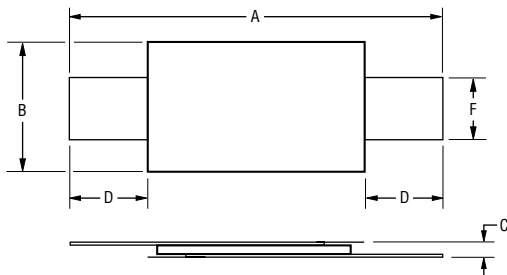

### "S" Style

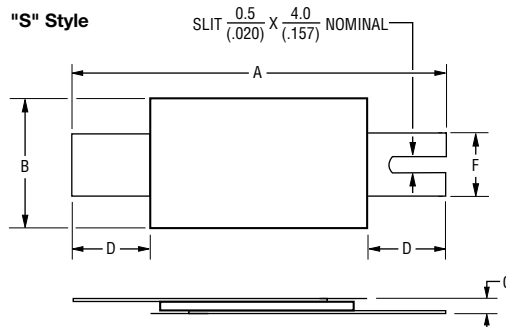

Terminal material: quarter-hard nickel

### Typical Part Marking

Represents total content. Layout may vary.

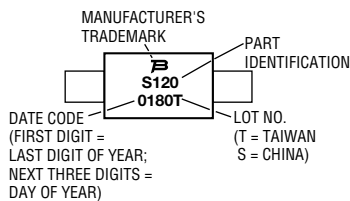

Specifications are subject to change without notice.  
Customers should verify actual device performance in their specific applications.

# MF-S Series - PTC Resettable Fuses

**BOURNS®**

## Typical Time to Trip at 23 °C

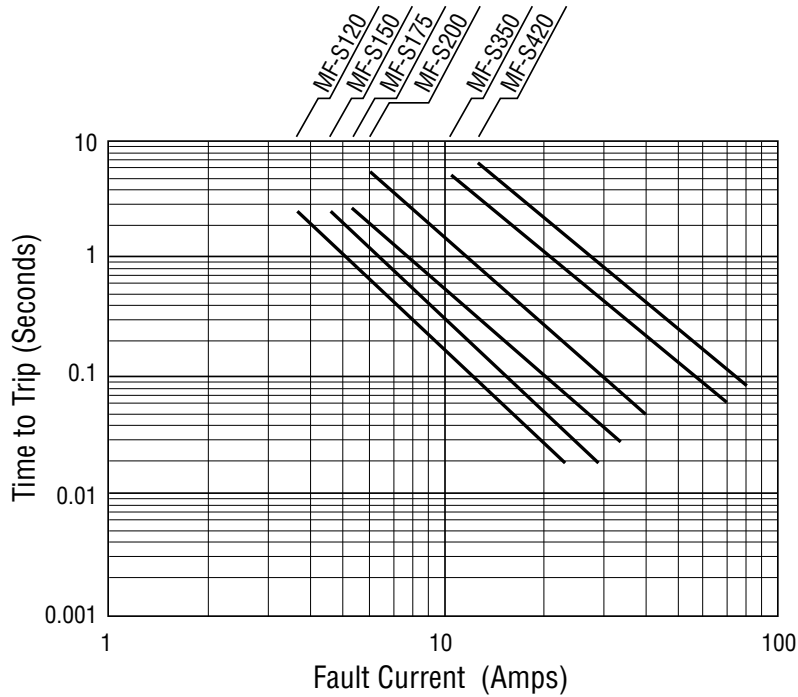

## How to Order

**MF - S 120 S -**

Multifuse® Product Designator \_\_\_\_\_

Series \_\_\_\_\_

S = Axial Leaded "Strap" Component

Hold Current,  $I_{hold}$  \_\_\_\_\_  
 120-420 (1.20 Amps - 4.20 Amps)

Slotted Lead Option \_\_\_\_\_

Packaging Options \_\_\_\_\_

- = Bulk Packaging
- 2 = Tape and Reel\*

\*Packaged per EIA486-B

**Taped Component Dimensions**

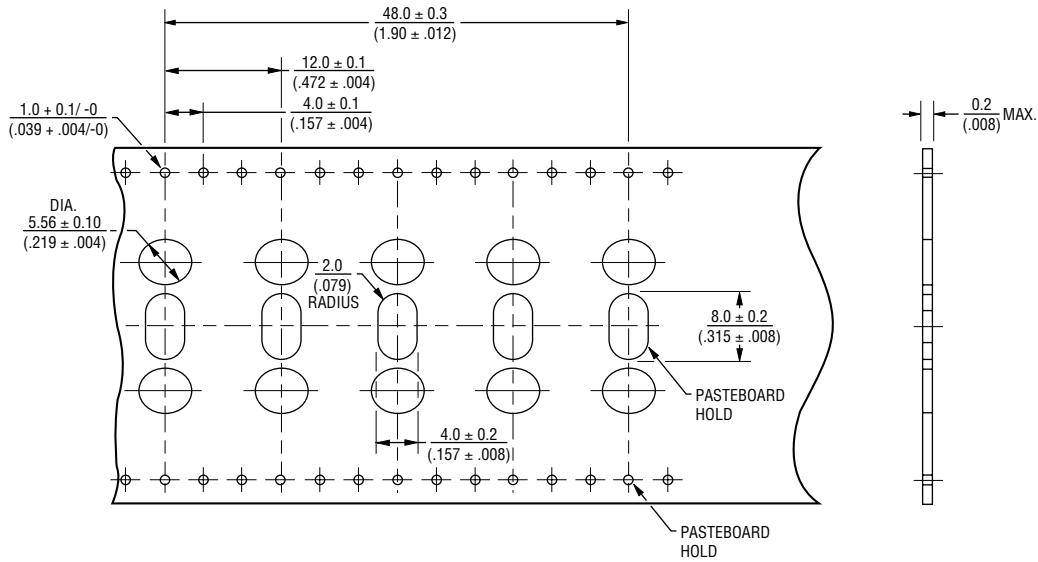

**Reel Dimensions**

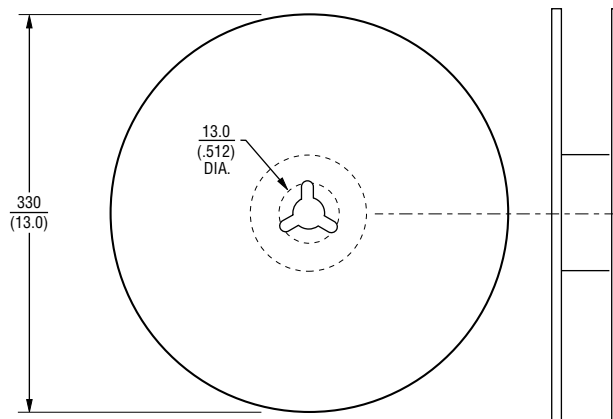

DIMENSIONS:  $\frac{\text{MM}}{\text{(INCHES)}}$

## Данный компонент на территории Российской Федерации

### Вы можете приобрести в компании MosChip.

Для оперативного оформления запроса Вам необходимо перейти по данной ссылке:

<http://moschip.ru/get-element>

Вы можете разместить у нас заказ для любого Вашего проекта, будь то серийное производство или разработка единичного прибора.

В нашем ассортименте представлены ведущие мировые производители активных и пассивных электронных компонентов.

Нашей специализацией является поставка электронной компонентной базы двойного назначения, продукции таких производителей как XILINX, Intel (ex.ALTERA), Vicor, Microchip, Texas Instruments, Analog Devices, Mini-Circuits, Amphenol, Glenair.

Сотрудничество с глобальными дистрибьюторами электронных компонентов, предоставляет возможность заказывать и получать с международных складов практически любой перечень компонентов в оптимальные для Вас сроки.

На всех этапах разработки и производства наши партнеры могут получить квалифицированную поддержку опытных инженеров.

Система менеджмента качества компании отвечает требованиям в соответствии с ГОСТ Р ИСО 9001, ГОСТ РВ 0015-002 и ЭС РД 009

### Офис по работе с юридическими лицами:

105318, г.Москва, ул.Щербаковская д.3, офис 1107, 1118, ДЦ «Щербаковский»

Телефон: +7 495 668-12-70 (многоканальный)

Факс: +7 495 668-12-70 (доб.304)

E-mail: [info@moschip.ru](mailto:info@moschip.ru)

Skype отдела продаж:

moschip.ru

moschip.ru\_4

moschip.ru\_6

moschip.ru\_9