

Single-PLL General Purpose EPROM Programmable Clock Generator

Features

- Single phase locked loop (PLL) architecture
- EPROM programmability
- Factory programmable (CY2907) or field programmable (CY2907F) device options
- Up to two configurable outputs
- Low skew, low jitter, high accuracy outputs
- Power management (power-down, OE)
- Frequency select option
- Configurable 5 V or 3.3 V Operation
- 8-pin SOIC package

Benefits

- Generates a custom frequency from an external source
- Easy customization and fast turnaround
- Programming support available for all opportunities
- Provides clocking requirements from a single device
- Meets critical industry standard timing requirements
- Supports low power applications
- Up to 16 user selectable frequencies
- Supports industry standard design platforms
- Industry standard packaging saves on board space

Functional Description

For a complete list of related documentation, click [here](#).

Logic Block Diagram

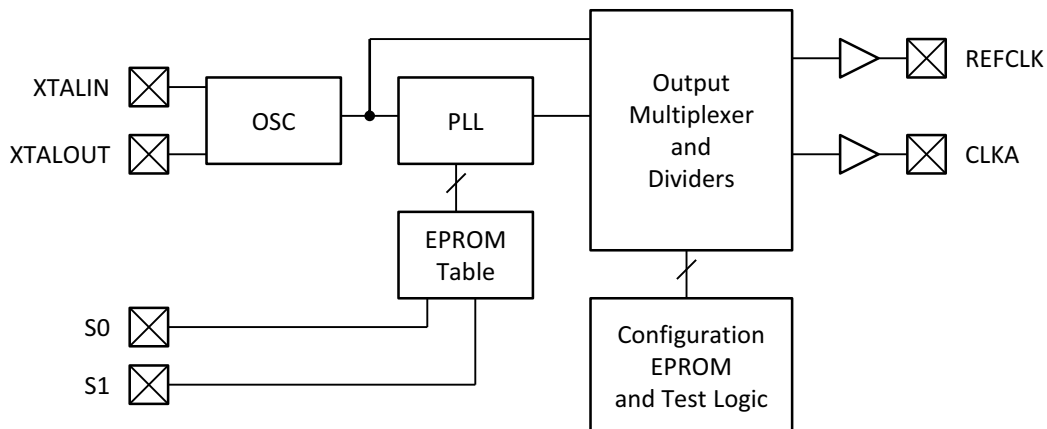

Contents

Pin Configurations	3	Ordering Information	10
Pin Description	3	Ordering Code Definitions	10
Functional Overview	4	Package Characteristics	10
Device Programming	4	Package Diagrams	11
CyberClocks™ Software	4	Acronyms	12
Cypress CY3670 Programming Kit	4	Document Conventions	12
Maximum Ratings	5	Units of Measure	12
Operating Conditions	5	Document History Page	13
Electrical Characteristics	6	Sales, Solutions, and Legal Information	15
Electrical Characteristics	6	Worldwide Sales and Design Support	15
Switching Characteristics	7	Products	15
Switching Characteristics	8	PSoC® Solutions	15
Switching Waveforms	9	Cypress Developer Community	15
Test Circuit	9	Technical Support	15

Pin Configurations

Figure 1. 8-pin SOIC pinout (Top View)

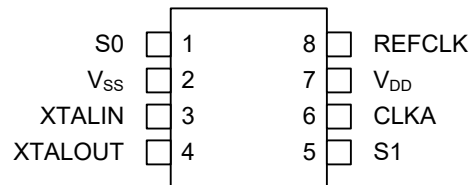

Pin Description

Name	Pin Number	Description
	8-pin SOIC	
S1	5	Frequency select (CLKA) (internal pull-up resistor to V _{DD})
V _{SS}	2	Ground
XTALIN ^[1]	3	Reference crystal input
XTALOUT ^[1, 2]	4	Reference crystal feedback
CLKA	6	Clock output
V _{DD}	7	Voltage supply
REFCLK	8	Reference clock output (default, can be driven by PLL if desired)
S0	1	Frequency select (CLKA) (internal pull-up resistor to V _{DD})

Notes

- For best accuracy, use a parallel resonant crystal, C_{LOAD} ≈ 17 pF.
- Float XTALOUT pin if XTALIN is driven by reference clock (as opposed to crystal).

Functional Overview

The CY2907 is a general purpose clock generator designed for use in a wide variety of applications — from graphics to PC peripherals to disk drives. It generates selectable system clock frequencies from a single reference input (crystal or reference clock). The CY2907 is configured with an EPROM array, similar to the other devices in the Cypress EPROM Programmable Clock family, making it easy to customize for any application. Furthermore, the CY2907 is compatible with all industry standard 9107 and 9108 clock synthesizers.

Device Programming

Two versions of the CY2907 are available - Field Programmable and Factory Programmable. Field programmable devices must be programmed before being installed in an application. They are one-time-programmable (OTP). Customers can program small quantities in-house using the Cypress CY3670 programmer. Production quantities are available through Cypress's value-added distribution partners, or by using third party programmers from BP Microsystems, Hi-Lo Systems, and others.

For high volume orders, devices can be factory programmed by Cypress. All requests must be submitted to the local Cypress Field Application Engineer (FAE) or sales representative. After the request is processed, you receive a new part number, samples, and a data sheet with the programmed values. This part number is used for additional sample requests and production orders.

CyberClocks™ Software

CyberClocks is an easy-to-use software application that enables the user to configure any one of the EPROM Programmable Clocks offered by Cypress. You may specify the input frequency, PLL and output frequencies, and different functional options. Note the output frequency ranges in this data sheet when specifying them in CyberClocks to make sure that you stay within the limits. After a configuration is established, you can print the configuration and save programming files in ENT and JED formats.

CyberClocks runs on PCs running the Windows™ operating system, and is available for free download on the Cypress Semiconductor website at www.cypress.com.

Within the CyberClocks application, the CY2907 is found in the CyClocks™ section. Note that the standalone CyberClocks software should not be confused with the CyberClocks Online software, which is a web-based application that is used to configure other programmable clock devices.

Cypress CY3670 Programming Kit

Cypress's CY3670 is a portable programmer that connects to a PC serial port and enables users of CyClocks software to quickly and easily program any of the CY2291F, CY2292F, CY2071AF, and CY2907F devices. An adapter is also required and is ordered separately. The CY3097 is the adapter for the CY2907F8.

Maximum Ratings

Exceeding maximum ratings may shorten the useful life of the device. User guidelines are not tested.

Supply voltage -0.5 to +7.0 V
 Input voltage -0.5 V to V_{DD} + 0.5 V

Storage temperature
 (non-condensing) -65 °C to +150 °C
 Max soldering temperature (10 sec) +260 °C
 Junction temperature +150 °C
 Static discharge voltage
 (per MIL-STD-883, method 3015) > 2000 V

Operating Conditions

Parameter ^[3]	Description	Min	Max	Unit
V _{DD}	Supply voltage, 5 V operation	4.5	5.5	V
	Supply voltage, 3.3 V operation	3.0	3.6	V
T _A	Commercial operating temperature, Ambient	0	70	°C
C _L	Maximum capacitive load	–	15	pF
f _{REF}	External reference crystal	10.0	25.0	MHz
	External reference clock ^[4, 5]	1.0	30.0	MHz

Notes

- 3. Electrical parameters are guaranteed with these operating conditions.
- 4. Guaranteed by design, not 100% tested in production.
- 5. Load = max typical configuration, f_{REF} = 14.318 MHz. Specific configurations may vary. A close approximation of I_{DD} can be derived by the following formula:
 $I_{DD} \text{ (mA)} = V_{DD} \times (6.25 + (0.055 \times f_{REF}) + (0.0017 \times C_{LOAD} \times (F_{CLKA} + REFCLK)))$. C_{LOAD} is specified in pF and F is specified in MHz.

:

Electrical Characteristics

At 5.0 V Commercial ($V_{DD} = 4.5\text{ V to }5.5\text{ V}$, $T_A = 0\text{ }^\circ\text{C to }+70\text{ }^\circ\text{C}$)

Parameter	Description	Test Conditions	Min	Max	Unit
V_{IH}	High-level input voltage	Except crystal inputs	2.0	–	V
V_{IL}	Low-level input voltage	Except crystal inputs	–	0.8	V
$V_{OH}^{[6]}$	High-level output voltage	$V_{DD} = V_{DD}\text{ Min.}$ $I_{OH} = -30\text{ mA}$ CLKA	2.4	–	V
$V_{OL}^{[6]}$	Low-level output voltage	$V_{DD} = V_{DD}\text{ Min.}$ $I_{OL} = 10\text{ mA}$ CLKA	–	0.4	V
$I_{OH}^{[6]}$	Output high current	$V_{OH} = 2.0\text{ V}$	–	–35	mA
$I_{OL}^{[6]}$	Output low current	$V_{OL} = 0.8\text{ V}$	22	–	mA
I_{IH}	Input high current	$V_{IH} = V_{DD}$	–2	2	μA
I_{IL}	Input low current	$V_{IL} = 0\text{ V}$	–	20	μA
$I_{DD}^{[7]}$	Power supply current	$\overline{\text{PD}}$ HIGH, CLKA = 50 MHz	–	42	mA
I_{DD}	Power supply current	$\overline{\text{PD}}$ LOW, Logic inputs LOW	–	100	μA
I_{DD}	Power supply current	$\overline{\text{PD}}$ LOW, Logic inputs HIGH	–	40	μA
$R_{PU}^{[6]}$	Pull-up resistor	$V_{IN} = V_{DD} - 1.0\text{ V}$	–	700	k Ω

Electrical Characteristics

At 3.3 V Commercial ($V_{DD} = 3.0\text{ V to }3.6\text{ V}$, $T_A = 0\text{ }^\circ\text{C to }+70\text{ }^\circ\text{C}$)

Parameter	Description	Test Conditions	Min	Max	Unit
V_{IH}	High-level input voltage	Except crystal inputs	$0.7 \times V_{DD}$	–	V
V_{IL}	Low-level input voltage	Except crystal inputs	–	$0.2 \times V_{DD}$	V
$V_{OH}^{[6]}$	High-level output voltage	CLKA, $I_{OH} = -5\text{ mA}$	$0.85 \times V_{DD}$	–	V
$V_{OL}^{[6]}$	Low-level output voltage	CLKA, $I_{OL} = 6\text{ mA}$	–	$0.1 \times V_{DD}$	V
$I_{OH}^{[6]}$	Output high current	$V_{OH} = 0.7 \times V_{DD}$	–	–10	mA
$I_{OL}^{[6]}$	Output low current	$V_{OL} = 0.2 \times V_{DD}$	15	–	mA
I_{IH}	Input high current	$V_{IH} = V_{DD}$	–2	2	μA
I_{IL}	Input low current	$V_{IL} = 0\text{ V}$	–	10	μA
$I_{DD}^{[7]}$	Power supply current	$\overline{\text{PD}}$ HIGH, CLKA = 50 MHz	–	40	mA
I_{DD}	Power supply current	$\overline{\text{PD}}$ LOW, Logic inputs LOW	–	40	μA
I_{DD}	Power supply current	$\overline{\text{PD}}$ LOW, Logic inputs HIGH	–	12	μA
$R_{PU}^{[6]}$	Pull-up resistor	$V_{IN} = V_{DD} - 0.5\text{ V}$	–	900	k Ω

Notes

6. Guaranteed by design, not 100% tested in production.

7. Load = max. typical configuration, $f_{REF} = 14.318\text{ MHz}$. Specific configurations may vary. A close approximation of I_{DD} can be derived by the following formula:
 $I_{DD}\text{ (mA)} = V_{DD} \times (6.25 + (0.055 \times F_{REF}) + (0.0017 \times C_{LOAD} \times (F_{CLKA} + REFCLK)))$. C_{LOAD} is specified in pF and F is specified in MHz.

Switching Characteristics

At 5.0 V Commercial

Parameter ^[8]	Output ^[9]	Description	Test Conditions	Min	Max	Unit
t _R	CLKA	Output rise time 0.8 V to 2.0 V	15 pF load	–	1.40	ns
t _F	CLKA	Output fall time 2.0 V to 0.8 V	15 pF load	–	1.00	ns
t _R	CLKA	Output rise time 20% to 80%	15 pF load	–	3.5	ns
t _F	CLKA	Output fall time 80% to 20%	15 pF load	–	2.5	ns
t _D	CLKA	Duty cycle	15 pF load at 1.4 V	45.0	55.0	%
F _I	XTALIN	Input frequency	Crystal oscillator	10	25	MHz
F _I	XTALIN	Input frequency	External input clock ^[10]	1	30	MHz
F _O	CLKA	Output frequency	CY2907, 15 pF load	0.5	130.0	MHz
			CY2907F, 15 pF load	0.5	100.0	MHz
t _{JIS}	CLKA	Jitter (one sigma)	20 MHz to 130 MHz	–	150	ps
t _{JIS}	CLKA	Jitter (one sigma)	14 MHz to 20 MHz	–	200	ps
t _{JIS}	CLKA	Jitter (one sigma)	Less than 14 MHz	–	1	%
t _{JAB}	CLKA	Jitter (absolute)	20 MHz to 130 MHz	–250	+ 250	ps
t _{JAB}	CLKA	Jitter (absolute)	14 MHz to 20 MHz	–500	+ 500	ps
t _{JAB}	CLKA	Jitter (absolute)	Less than 14 MHz	–	3	%
t _{PU}		Power-up time		–	18	ms
t _{FT}	CLKA	Transition time	8 MHz to 66.6 MHz	–	13	ms

Notes

8. Guaranteed by design, not 100% tested in production.

9. REFCLK output can also be configured to be driven by the PLL. In that case these characteristics are also valid.

10. Refer to the application note *Crystal Oscillator Topics* when using an external reference clock as an input frequency source.

Switching Characteristics

At 3.3 V Commercial

Parameter ^[11]	Output ^[12]	Description	Test Conditions	Min	Max	Unit
t_R	CLKA	Output rise time 20% to 80%	15 pF Load	–	3.5	ns
t_F	CLKA	Output fall time 80% to 20%	15 pF Load	–	2.5	ns
t_D	CLKA	Duty cycle	15 pF Load at 1.4 V	40.0	53.0	%
F_I	XTALIN	Input frequency	Crystal Oscillator	10	25	MHz
F_I	XTALIN	Input frequency	External Input Clock ^[13]	1	30	MHz
F_O	CLKA	Output frequency	CY2907, 15 pF Load	0.5	100.0	MHz
			CY2907F, 15 pF Load	0.5	80.0	MHz
t_{JIS}	CLKA	Jitter (one sigma)	25 MHz to 100 MHz	–	150	ps
t_{JIS}	CLKA	Jitter (one sigma)	14 MHz to 25 MHz	–	200	ps
t_{JIS}	CLKA	Jitter (one sigma)	Less than 14 MHz	–	1	%
t_{JAB}	CLKA	Jitter (absolute)	25 MHz to 120 MHz	–250	+250	ps
t_{JAB}	CLKA	Jitter (absolute)	14 MHz to 25 MHz	–500	+500	ps
t_{JAB}	CLKA	Jitter (absolute)	Less than 14 MHz	–	3	%
t_{PU}		Power-up time		–	18	ms
t_{FT}	CLKA	Transition time	8 MHz to 66.6 MHz	–	13	ms

Notes

11. Guaranteed by design, not 100% tested in production.

12. REFCLK output can also be configured to be driven by the PLL. In that case these characteristics are also valid.

13. Refer to the application note *Crystal Oscillator Topics* when using an external reference clock as an input frequency source.

Switching Waveforms

Figure 2. Frequency Select Change (Transition Time)

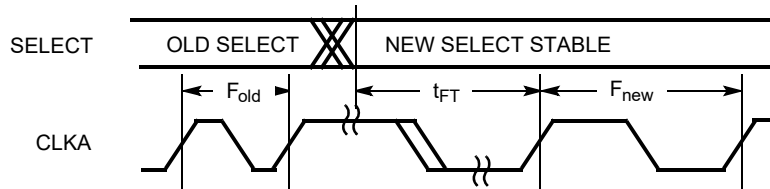

Figure 3. Duty Cycle Timing

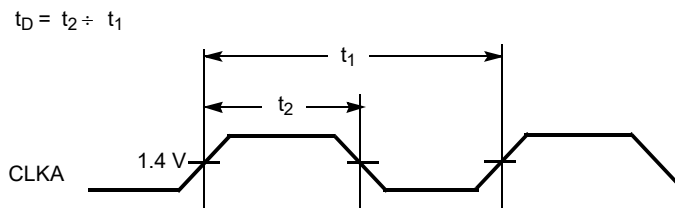
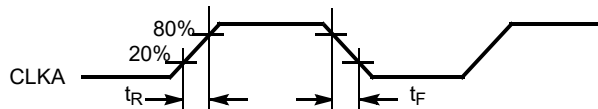
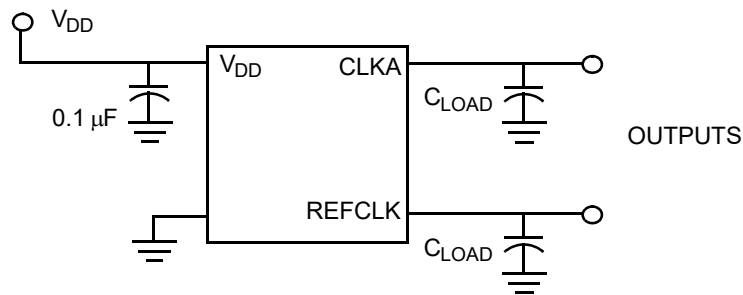

Figure 4. All Outputs Rise/Fall Time



Test Circuit

Figure 5. Test Circuit



Note: All capacitors should be placed as close to each pin as possible.

Package Diagrams

Figure 6. 8-pin SOIC (150 Mils) S0815/SZ815/SW815 Package Outline, 51-85066

1. DIMENSIONS IN INCHES[MM] MIN.
MAX.
2. PIN 1 ID IS OPTIONAL,
ROUND ON SINGLE LEADFRAME
RECTANGULAR ON MATRIX LEADFRAME
3. REFERENCE JEDEC MS-012
4. PACKAGE WEIGHT 0.07gms

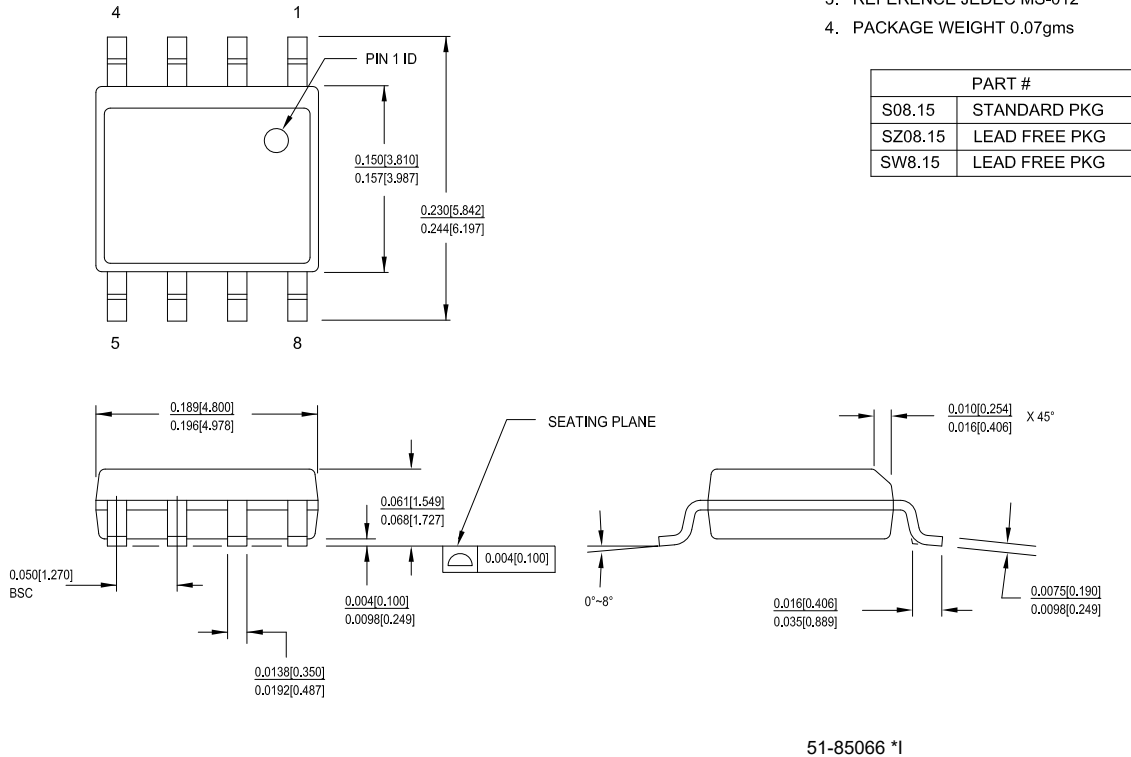

PART #	
S08.15	STANDARD PKG
SZ08.15	LEAD FREE PKG
SW8.15	LEAD FREE PKG

51-85066 *I

Acronyms

Acronym	Description
EPROM	Erasable Programmable Read Only Memory
OE	Output Enable
PLL	Phase-Locked Loop
SOIC	Small-Outline Integrated Circuit
TSSOP	Thin-Shrink Small Outline Package

Document Conventions

Units of Measure

Symbol	Unit of Measure
°C	degree Celsius
kΩ	kilohm
MHz	megahertz
μA	microampere
mA	milliampere
ms	millisecond
mW	milliwatt
ns	nanosecond
ppm	parts per million
%	percent
pF	picofarad
ps	picosecond
V	volt

Document History Page

Document Title: CY2907, Single-PLL General Purpose EPROM Programmable Clock Generator Document Number: 38-07137				
Revision	ECN	Orig. of Change	Submission Date	Description of Change
**	110246	SZV	12/18/2001	Changed from Spec number: 38-00505 to 38-07137.
*A	1088524	KVM / KKVTMP	05/21/2007	Added Device Programming . Updated Ordering Information : Updated part numbers. Updated to new template.
*B	2715646	KVM / AESA	06/10/2009	Removed Industrial Temperature Range related information in all instances across the document. Removed Selector Guide. Updated Ordering Information : Updated part numbers. Added Note 14 and referred the same note in all MPNs except CY3670. Completing Sunset Review.
*C	2948496	KVM	06/09/2010	Updated Ordering Information : Updated part numbers. Updated Package Diagrams : spec 51-85066 – Changed revision from *C to *D. spec 51-85067 – Changed revision from *B to *C. Completing Sunset Review.
*D	3051170	BASH	10/07/2010	Updated Ordering Information : Updated part numbers. Added Ordering Code Definitions . Added Acronyms and Units of Measure . Minor edits.
*E	3155189	BASH	01/27/2011	Minor Change: Post to external web.
*F	3402027	BASH	10/11/2011	Updated Ordering Information : Updated part numbers. Updated Package Diagrams : spec 51-85066 – Changed revision from *D to *E. spec 51-85067 – Changed revision from *C to *D.
*G	4047640	CINM	07/02/2013	Updated Package Diagrams : spec 51-85066 – Changed revision from *E to *F. Completing Sunset Review.
*H	4399810	AJU	06/05/2014	Added watermark “Not Recommended for New Designs”. Updated to new template.
*I	4587350	AJU	12/05/2014	Removed watermark “Not Recommended for New Designs”. Updated Functional Description : Added “For a complete list of related documentation, click here .” at the end. Updated Ordering Information : Updated part numbers.
*J	5366091	TAVA	07/22/2016	Removed 14-pin SOIC package related information in all instances across the document. Updated Logic Block Diagram . Updated Cypress CY3670 Programming Kit : Updated description. Updated Package Diagrams : spec 51-85066 – Changed revision from *F to *H. Removed spec 51-85067 *D. Updated to new template. Completing Sunset Review.

Document History Page (continued)

Document Title: CY2907, Single-PLL General Purpose EPROM Programmable Clock Generator Document Number: 38-07137				
Revision	ECN	Orig. of Change	Submission Date	Description of Change
*K	6074874	PAWK	02/19/2018	Updated Package Diagrams : spec 51-85066 – Changed revision from *H to *I. Updated to new template.

Sales, Solutions, and Legal Information

Worldwide Sales and Design Support

Cypress maintains a worldwide network of offices, solution centers, manufacturer's representatives, and distributors. To find the office closest to you, visit us at [Cypress Locations](#).

Products

Arm® Cortex® Microcontrollers	cypress.com/arm
Automotive	cypress.com/automotive
Clocks & Buffers	cypress.com/clocks
Interface	cypress.com/interface
Internet of Things	cypress.com/iot
Memory	cypress.com/memory
Microcontrollers	cypress.com/mcu
PSoC	cypress.com/psoc
Power Management ICs	cypress.com/pmic
Touch Sensing	cypress.com/touch
USB Controllers	cypress.com/usb
Wireless Connectivity	cypress.com/wireless

PSoC® Solutions

[PSoC 1](#) | [PSoC 3](#) | [PSoC 4](#) | [PSoC 5LP](#) | [PSoC 6 MCU](#)

Cypress Developer Community

[Community](#) | [Projects](#) | [Video](#) | [Blogs](#) | [Training](#) | [Components](#)

Technical Support

cypress.com/support

© Cypress Semiconductor Corporation, 2001-2018. This document is the property of Cypress Semiconductor Corporation and its subsidiaries, including Spansion LLC ("Cypress"). This document, including any software or firmware included or referenced in this document ("Software"), is owned by Cypress under the intellectual property laws and treaties of the United States and other countries worldwide. Cypress reserves all rights under such laws and treaties and does not, except as specifically stated in this paragraph, grant any license under its patents, copyrights, trademarks, or other intellectual property rights. If the Software is not accompanied by a license agreement and you do not otherwise have a written agreement with Cypress governing the use of the Software, then Cypress hereby grants you a personal, non-exclusive, nontransferable license (without the right to sublicense) (1) under its copyright rights in the Software (a) for Software provided in source code form, to modify and reproduce the Software solely for use with Cypress hardware products, only internally within your organization, and (b) to distribute the Software in binary code form externally to end users (either directly or indirectly through resellers and distributors), solely for use on Cypress hardware product units, and (2) under those claims of Cypress's patents that are infringed by the Software (as provided by Cypress, unmodified) to make, use, distribute, and import the Software solely for use with Cypress hardware products. Any other use, reproduction, modification, translation, or compilation of the Software is prohibited.

TO THE EXTENT PERMITTED BY APPLICABLE LAW, CYPRESS MAKES NO WARRANTY OF ANY KIND, EXPRESS OR IMPLIED, WITH REGARD TO THIS DOCUMENT OR ANY SOFTWARE OR ACCOMPANYING HARDWARE, INCLUDING, BUT NOT LIMITED TO, THE IMPLIED WARRANTIES OF MERCHANTABILITY AND FITNESS FOR A PARTICULAR PURPOSE. To the extent permitted by applicable law, Cypress reserves the right to make changes to this document without further notice. Cypress does not assume any liability arising out of the application or use of any product or circuit described in this document. Any information provided in this document, including any sample design information or programming code, is provided only for reference purposes. It is the responsibility of the user of this document to properly design, program, and test the functionality and safety of any application made of this information and any resulting product. Cypress products are not designed, intended, or authorized for use as critical components in systems designed or intended for the operation of weapons, weapons systems, nuclear installations, life-support devices or systems, other medical devices or systems (including resuscitation equipment and surgical implants), pollution control or hazardous substances management, or other uses where the failure of the device or system could cause personal injury, death, or property damage ("Unintended Uses"). A critical component is any component of a device or system whose failure to perform can be reasonably expected to cause the failure of the device or system, or to affect its safety or effectiveness. Cypress is not liable, in whole or in part, and you shall and hereby do release Cypress from any claim, damage, or other liability arising from or related to all Unintended Uses of Cypress products. You shall indemnify and hold Cypress harmless from and against all claims, costs, damages, and other liabilities, including claims for personal injury or death, arising from or related to any Unintended Uses of Cypress products.

Cypress, the Cypress logo, Spansion, the Spansion logo, and combinations thereof, WICED, PSoC, CapSense, EZ-USB, F-RAM, and Traveo are trademarks or registered trademarks of Cypress in the United States and other countries. For a more complete list of Cypress trademarks, visit cypress.com. Other names and brands may be claimed as property of their respective owners.

Данный компонент на территории Российской Федерации

Вы можете приобрести в компании MosChip.

Для оперативного оформления запроса Вам необходимо перейти по данной ссылке:

<http://moschip.ru/get-element>

Вы можете разместить у нас заказ для любого Вашего проекта, будь то серийное производство или разработка единичного прибора.

В нашем ассортименте представлены ведущие мировые производители активных и пассивных электронных компонентов.

Нашей специализацией является поставка электронной компонентной базы двойного назначения, продукции таких производителей как XILINX, Intel (ex.ALTERA), Vicor, Microchip, Texas Instruments, Analog Devices, Mini-Circuits, Amphenol, Glenair.

Сотрудничество с глобальными дистрибьюторами электронных компонентов, предоставляет возможность заказывать и получать с международных складов практически любой перечень компонентов в оптимальные для Вас сроки.

На всех этапах разработки и производства наши партнеры могут получить квалифицированную поддержку опытных инженеров.

Система менеджмента качества компании отвечает требованиям в соответствии с ГОСТ Р ИСО 9001, ГОСТ РВ 0015-002 и ЭС РД 009

Офис по работе с юридическими лицами:

105318, г.Москва, ул.Щербаковская д.3, офис 1107, 1118, ДЦ «Щербаковский»

Телефон: +7 495 668-12-70 (многоканальный)

Факс: +7 495 668-12-70 (доб.304)

E-mail: info@moschip.ru

Skype отдела продаж:

moschip.ru

moschip.ru_4

moschip.ru_6

moschip.ru_9