

CAT5113

100-Tap Digitally Programmable Potentiometer (DPP)

Description

The CAT5113 is a single digitally programmable potentiometer (DPP) designed as an electronic replacement for mechanical potentiometers. Ideal for automated adjustments on high volume production lines, they are also well suited for applications where equipment requiring periodic adjustment is either difficult to access or located in a hazardous or remote environment.

The CAT5113 contains a 100-tap series resistor array connected between two terminals R_H and R_L . An up/down counter and decoder that are controlled by three input pins, determines which tap is connected to the wiper, R_W . The wiper setting, stored in nonvolatile memory, is not lost when the device is powered down and is automatically reinstated when power is returned. The wiper can be adjusted to test new system values without affecting the stored setting. Wiper-control of the CAT5113 is accomplished with three input control pins, \overline{CS} , U/\overline{D} , and \overline{INC} . The \overline{INC} input increments the wiper in the direction which is determined by the logic state of the U/\overline{D} input. The \overline{CS} input is used to select the device and also store the wiper position prior to power down.

The digitally programmable potentiometer can be used as a three-terminal resistive divider or as a two-terminal variable resistor.

Features

- 100-position Linear Taper Potentiometer
- Non-volatile EEPROM Wiper Storage
- 10 nA Ultra-low Standby Current
- Single Supply Operation: 2.5 V – 6.0 V
- Increment Up/Down Serial Interface
- Resistance Values: 1 k Ω , 10 k Ω , 50 k Ω and 100 k Ω
- Available in PDIP, SOIC, TSSOP and MSOP Packages
- These Devices are Pb-Free, Halogen Free/BFR Free and are RoHS Compliant

Applications

- Automated Product Calibration
- Remote Control Adjustments
- Offset, Gain and Zero Control
- Tamper-proof Calibrations
- Contrast, Brightness and Volume Controls
- Motor Controls and Feedback Systems
- Programmable Analog Functions



ON Semiconductor®

<http://onsemi.com>



SOIC-8
V SUFFIX
CASE 751BD



MSOP-8
Z SUFFIX
CASE 846AD



PDIP-8
L SUFFIX
CASE 646AA



TSSOP-8
Y SUFFIX
CASE 948AL

PIN CONFIGURATIONS

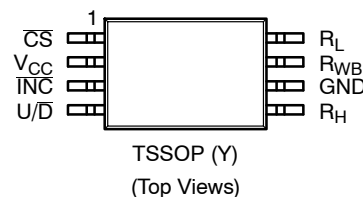
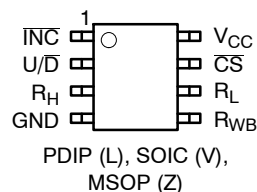

PIN FUNCTION

Pin Name	Function
\overline{INC}	Increment Control
U/\overline{D}	Up/Down Control
R_H	Potentiometer High Terminal
GND	Ground
R_W	Wiper Terminal
R_L	Potentiometer Low Terminal
\overline{CS}	Chip Select
V_{CC}	Supply Voltage

ORDERING INFORMATION

See detailed ordering and shipping information in the package dimensions section on page 9 of this data sheet.

CAT5113

DEVICE MARKING INFORMATION

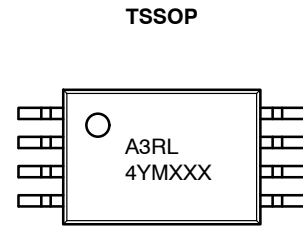
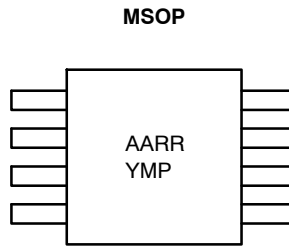
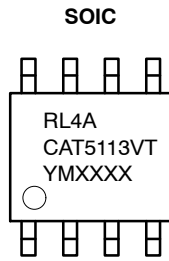
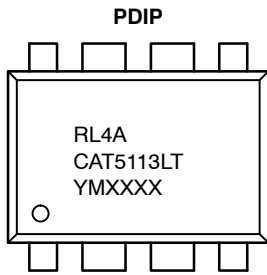

R = Resistance:

0 = 1 k Ω

2 = 10 k Ω

4 = 50 k Ω

5 = 100 k Ω

L = Assembly Location

4 = Lead Finish - NiPdAu

A = Product Revision (Fixed as "A")

CAT5113L = Device Code (PDIP)

CAT5113V = Device Code (SOIC)

T = Temperature Range (Industrial)

Y = Production Year (Last Digit)

M = Production Month (1-9, A, B, C)

XXXX = Last Four Digits of Assembly Lot Number

AARR = CAT5113ZI-10-T3

AARC = CAT5113ZI-50-T3

AARG = CAT5113ZI-00-T3

Y = Production Year (Last Digit)

M = Production Month (1-9, A, B, C)

P = Product Revision

A3 = Device Code

R = Resistance:

2 = 10 k Ω

4 = 50 k Ω

5 = 100 k Ω

L = Assembly Location

4 = Lead Finish - NiPdAu

Y = Production Year (Last Digit)

M = Production Month (1-9, A, B, C)

XXX = Last Three Digits of

Assembly Lot Number

Functional Diagram



Figure 1. General

Figure 2. Detailed

Figure 3. Electronic Potentiometer Implementation

Pin Description

\overline{INC} : Increment Control Input

The \overline{INC} input moves the wiper in the up or down direction determined by the condition of the U/\overline{D} input.

U/\overline{D} : Up/Down Control Input

The U/\overline{D} input controls the direction of the wiper movement. When in a high state and \overline{CS} is low, any high-to-low transition on \overline{INC} will cause the wiper to move one increment toward the R_H terminal. When in a low state and \overline{CS} is low, any high-to-low transition on \overline{INC} will cause the wiper to move one increment towards the R_L terminal.

R_H : High End Potentiometer Terminal

R_H is the high end terminal of the potentiometer. It is not required that this terminal be connected to a potential greater than the R_L terminal. Voltage applied to the R_H terminal cannot exceed the supply voltage, V_{CC} or go below ground, GND .

R_W : Wiper Potentiometer Terminal

R_W is the wiper terminal of the potentiometer. Its position on the resistor array is controlled by the control inputs, \overline{INC} , U/\overline{D} and \overline{CS} . Voltage applied to the R_W terminal cannot exceed the supply voltage, V_{CC} or go below ground, GND .

R_L : Low End Potentiometer Terminal

R_L is the low end terminal of the potentiometer. It is not required that this terminal be connected to a potential less than the R_H terminal. Voltage applied to the R_L terminal cannot exceed the supply voltage, V_{CC} or go below ground, GND . R_L and R_H are electrically interchangeable.

\overline{CS} : Chip Select

The chip select input is used to activate the control input of the CAT5113 and is active low. When in a high state, activity on the \overline{INC} and U/\overline{D} inputs will not affect or change the position of the wiper.

Device Operation

The CAT5113 operates like a digitally controlled potentiometer with R_H and R_L equivalent to the high and low terminals and R_W equivalent to the mechanical potentiometer's wiper. There are 100 available tap positions including the resistor end points, R_H and R_L terminals. The wiper terminal is connected to one of the 100 taps and controlled by three inputs, \overline{INC} , U/\overline{D} and \overline{CS} . These inputs control a seven-bit up/down counter whose output is decoded to select the wiper position. The selected wiper position can be stored in nonvolatile memory using the \overline{INC} and \overline{CS} inputs.

With \overline{CS} set LOW the CAT5113 is selected and will respond to the U/\overline{D} and \overline{INC} inputs. HIGH to LOW transitions on \overline{INC} will increment or decrement the wiper (depending on the state of the U/\overline{D} input and seven-bit counter). The wiper, when at either fixed terminal, acts like its mechanical equivalent and does not move beyond the last position. The value of the counter is stored in nonvolatile memory whenever \overline{CS} transitions HIGH while the \overline{INC} input is also HIGH. When the CAT5113 is powered-down, the last stored wiper counter position is maintained in the nonvolatile memory. When power is restored, the contents of the memory are recalled and the counter is set to the value stored.

With \overline{INC} set low, the CAT5113 may be de-selected and powered down without storing the current wiper position in nonvolatile memory. This allows the system to always power up to a preset value stored in nonvolatile memory.

CAT5113

Table 1. OPERATION MODES

$\overline{\text{INC}}$	$\overline{\text{CS}}$	$\text{U}/\overline{\text{D}}$	Operation
High to Low	Low	High	Wiper toward H
High to Low	Low	Low	Wiper toward L
High	Low to High	X	Store Wiper Position
Low	Low to High	X	No Store, Return to Standby
X	High	X	Standby

Table 2. ABSOLUTE MAXIMUM RATINGS

Parameters	Ratings	Units
Supply Voltage V_{CC} to GND	-0.5 to +7	V
Inputs $\overline{\text{CS}}$ to GND	-0.5 to $V_{\text{CC}} + 0.5$	V
$\overline{\text{INC}}$ to GND	-0.5 to $V_{\text{CC}} + 0.5$	V
$\text{U}/\overline{\text{D}}$ to GND	-0.5 to $V_{\text{CC}} + 0.5$	V
H to GND	-0.5 to $V_{\text{CC}} + 0.5$	V
L to GND	-0.5 to $V_{\text{CC}} + 0.5$	V
W to GND	-0.5 to $V_{\text{CC}} + 0.5$	V
Operating Ambient Temperature Commercial ('C' or Blank suffix)	0 to 70	°C
Industrial ('I' suffix)	-40 to +85	°C
Junction Temperature	+150	°C
Storage Temperature	-65 to 150	°C
Lead Soldering (10 s max)	+300	°C

Stresses exceeding Maximum Ratings may damage the device. Maximum Ratings are stress ratings only. Functional operation above the Recommended Operating Conditions is not implied. Extended exposure to stresses above the Recommended Operating Conditions may affect device reliability.

Table 3. RELIABILITY CHARACTERISTICS

Symbol	Parameter	Test Method	Min	Typ	Max	Units
V_{ZAP} (Note 1)	ESD Susceptibility	MIL-STD-883, Test Method 3015	2000			V
I_{LTH} (Notes 1, 2)	Latch-Up	JEDEC Standard 17	100			mA
T_{DR}	Data Retention	MIL-STD-883, Test Method 1008	100			Years
N_{END}	Endurance	MIL-STD-883, Test Method 1003	1,000,000			Stores

1. This parameter is tested initially and after a design or process change that affects the parameter.
2. Latch-up protection is provided for stresses up to 100 mA on address and data pins from -1 V to $V_{\text{CC}} + 1$ V

CAT5113

Table 4. DC ELECTRICAL CHARACTERISTICS ($V_{CC} = +2.5\text{ V to }+6\text{ V}$ unless otherwise specified)

Symbol	Parameter	Conditions	Min	Typ	Max	Units
POWER SUPPLY						
V_{CC}	Operating Voltage Range		2.5	–	6.0	V
I_{CC1}	Supply Current (Increment)	$V_{CC} = 6\text{ V}, f = 1\text{ MHz}, I_W = 0$	–	–	100	μA
		$V_{CC} = 6\text{ V}, f = 250\text{ kHz}, I_W = 0$	–	–	50	μA
I_{CC2}	Supply Current (Write)	Programming, $V_{CC} = 6\text{ V}$	–	–	1000	μA
		$V_{CC} = 3\text{ V}$	–	–	500	μA
I_{SB1} (Note 3)	Supply Current (Standby)	$\overline{CS} = V_{CC} - 0.3\text{ V}$ $U/\overline{D}, \overline{INC} = V_{CC} - 0.3\text{ V}$ or GND	–	0.01	1	μA
LOGIC INPUTS						
I_{IH}	Input Leakage Current	$V_{IN} = V_{CC}$	–	–	10	μA
I_{IL}	Input Leakage Current	$V_{IN} = 0\text{ V}$	–	–	–10	μA
V_{IH2}	CMOS High Level Input Voltage	$2.5\text{ V} \leq V_{CC} \leq 6\text{ V}$	$V_{CC} \times 0.7$	–	$V_{CC} + 0.3$	V
V_{IL2}	CMOS Low Level Input Voltage		–0.3	–	$V_{CC} \times 0.2$	V
POTENTIOMETER CHARACTERISTICS						
R_{POT}	Potentiometer Resistance	–01 Device		1		k Ω
		–10 Device		10		
		–50 Device		50		
		–00 Device		100		
	Pot. Resistance Tolerance				± 20	%
V_{RH}	Voltage on R_H pin		0		V_{CC}	V
V_{RL}	Voltage on R_L pin		0		V_{CC}	V
	Resolution			1		%
INL	Integral Linearity Error	$I_W \leq 2\ \mu\text{A}$		0.5	1	LSB
DNL	Differential Linearity Error	$I_W \leq 2\ \mu\text{A}$		0.25	0.5	LSB
R_{WI}	Wiper Resistance	$V_{CC} = 5\text{ V}, I_W = 1\text{ mA}$			400	Ω
		$V_{CC} = 2.5\text{ V}, I_W = 1\text{ mA}$			1000	Ω
I_W	Wiper Current	(Note 4)	–4.4		4.4	mA
TC_{RPOT}	TC of Pot Resistance			300		ppm/ $^{\circ}\text{C}$
TC_{RATIO}	Ratiometric TC				20	ppm/ $^{\circ}\text{C}$
V_N	Noise	100 kHz / 1 kHz		8/24		nV/ $\sqrt{\text{Hz}}$
$C_H/C_L/C_W$	Potentiometer Capacitances			8/8/25		pF
fc	Frequency Response	Passive Attenuator, 10 k Ω		1.7		MHz

3. Latch-up protection is provided for stresses up to 100 mA on address and data pins from -1 V to $V_{CC} + 1\text{ V}$

4. This parameter is not 100% tested.

Table 5. AC TEST CONDITIONS

V _{CC} Range	2.5 V ≤ V _{CC} ≤ 6 V
Input Pulse Levels	0.2 V _{CC} to 0.7 V _{CC}
Input Rise and Fall Times	10 ns
Input Reference Levels	0.5 V _{CC}

Table 6. AC OPERATING CHARACTERISTICS (V_{CC} = +2.5 V to +6.0 V, V_H = V_{CC}, V_L = 0 V, unless otherwise specified)

Symbol	Parameter	Min	Typ (Note 5)	Max	Units
t _{CI}	\overline{CS} to \overline{INC} Setup	100	-	-	ns
t _{DI}	U/ \overline{D} to \overline{INC} Setup	50	-	-	ns
t _{ID}	U/ \overline{D} to \overline{INC} Hold	100	-	-	ns
t _{IL}	\overline{INC} LOW Period	250	-	-	ns
t _{IH}	\overline{INC} HIGH Period	250	-	-	ns
t _{IC}	\overline{INC} Inactive to \overline{CS} Inactive	1	-	-	μs
t _{CPH}	\overline{CS} Deselect Time (NO STORE)	100	-	-	ns
t _{CPH}	\overline{CS} Deselect Time (STORE)	10	-	-	ms
t _{IW}	\overline{INC} to V _{OUT} Change	-	1	5	μs
t _{CYC}	\overline{INC} Cycle Time	1	-	-	μs
t _R , t _F (Note 6)	\overline{INC} Input Rise and Fall Time	-	-	500	μs
t _{PU} (Note 6)	Power-up to Wiper Stable	-	-	1	ms
t _{WR}	Store Cycle	-	5	10	ms

5. Typical values are for T_A = 25°C and nominal supply voltage.

6. This parameter is periodically sampled and not 100% tested.

7. MI in the A.C. Timing diagram refers to the minimum incremental change in the W output due to a change in the wiper position.



Figure 4. A.C. Timing

CAT5113

Applications Information



Figure 5. Potentiometer Configuration

Applications

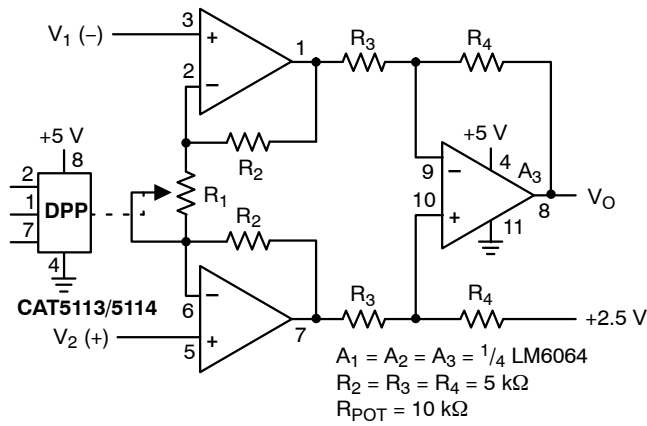

Figure 6. Programmable Instrumentation Amplifier



Figure 7. Programmable Sq. Wave Oscillator (555)



Figure 8. Sensor Auto Referencing Circuit

CAT5113



Figure 9. Programmable Voltage Regulator



Figure 10. Programmable I to V Converter



Figure 11. Automatic Gain Control

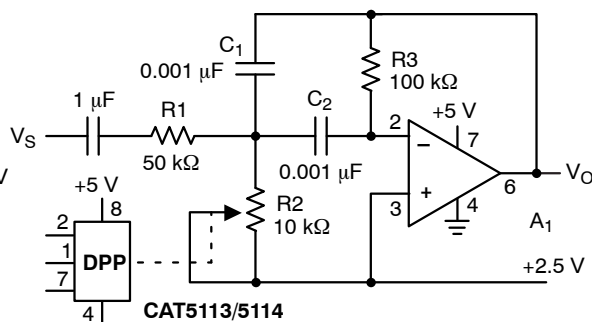

Figure 12. Programmable Bandpass Filter



Figure 13. Programmable Current Source/Sink

CAT5113

Table 7. ORDERING INFORMATION

Orderable Part Number	Resistance (kΩ)	Lead Finish	Package-Pins	Shipping [†]
CAT5113LI-01-G	1	NiPdAu	PDIP-8 (Pb-Free)	50 Units / Rail
CAT5113LI-10-G	10			
CAT5113LI-50-G	50			
CAT5113LI-00-G	100			
CAT5113VI-01-GT3	1	NiPdAu	SOIC-8 (Pb-Free)	3000 / Tape & Reel
CAT5113VI-10-GT3	10			
CAT5113VI-50-GT3	50			
CAT5113VI-00-GT3	100			
CAT5113YI-01-GT3	1	NiPdAu	TSSOP-8 (Pb-Free)	3000 / Tape & Reel
CAT5113YI-10-GT3	10			
CAT5113YI-50-GT3	50			
CAT5113YI-00-GT3	100			
CAT5113ZI-01-T3	1	Matte-Tin	MSOP-8 (Pb-Free)	3000 / Tape & Reel
CAT5113ZI-10-T3	10			
CAT5113ZI-50-T3	50			
CAT5113ZI-00-T3	100			

[†]For information on tape and reel specifications, including part orientation and tape sizes, please refer to our Tape and Reel Packaging Specifications Brochure, BRD8011/D.

8. All packages are RoHS-compliant (Pb-Free, Halogen-Free).

9. The standard lead finish is NiPdAu, except MSOP package is Matte-Tin.

10. Contact factory for Matte-Tin finish availability for PDIP, SOIC and TSSOP packages.

CAT5113

PACKAGE DIMENSIONS

PDIP-8, 300 mils
CASE 646AA-01
ISSUE A



SYMBOL	MIN	NOM	MAX
A			5.33
A1	0.38		
A2	2.92	3.30	4.95
b	0.36	0.46	0.56
b2	1.14	1.52	1.78
c	0.20	0.25	0.36
D	9.02	9.27	10.16
E	7.62	7.87	8.25
E1	6.10	6.35	7.11
e	2.54 BSC		
eB	7.87		10.92
L	2.92	3.30	3.80

TOP VIEW



SIDE VIEW



END VIEW

Notes:

- (1) All dimensions are in millimeters.
- (2) Complies with JEDEC MS-001.

CAT5113

PACKAGE DIMENSIONS

SOIC 8, 150 mils
CASE 751BD-01
ISSUE O

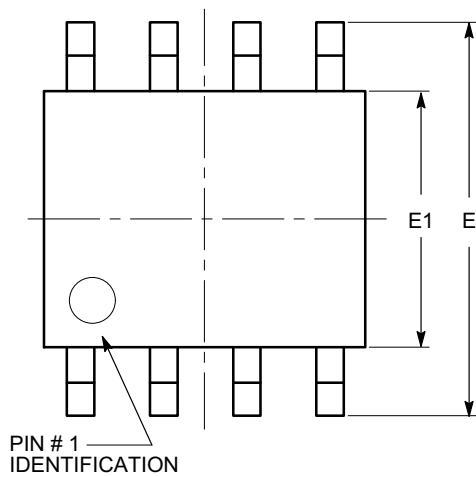

TOP VIEW

SYMBOL	MIN	NOM	MAX
A	1.35		1.75
A1	0.10		0.25
b	0.33		0.51
c	0.19		0.25
D	4.80		5.00
E	5.80		6.20
E1	3.80		4.00
e	1.27 BSC		
h	0.25		0.50
L	0.40		1.27
θ	0°		8°

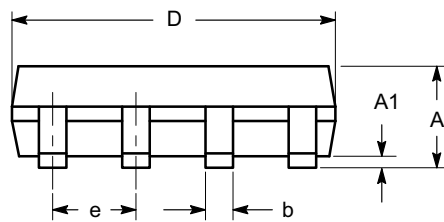

SIDE VIEW

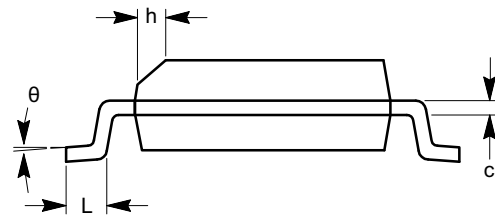

END VIEW

Notes:

- (1) All dimensions are in millimeters. Angles in degrees.
- (2) Complies with JEDEC MS-012.

CAT5113

PACKAGE DIMENSIONS

TSSOP8, 4.4x3
CASE 948AL-01
ISSUE O



SYMBOL	MIN	NOM	MAX
A			1.20
A1	0.05		0.15
A2	0.80	0.90	1.05
b	0.19		0.30
c	0.09		0.20
D	2.90	3.00	3.10
E	6.30	6.40	6.50
E1	4.30	4.40	4.50
e	0.65 BSC		
L	1.00 REF		
L1	0.50	0.60	0.75
θ	0°		8°

TOP VIEW



SIDE VIEW



END VIEW

Notes:

- (1) All dimensions are in millimeters. Angles in degrees.
- (2) Complies with JEDEC MO-153.

CAT5113

PACKAGE DIMENSIONS

MSOP 8, 3x3
CASE 846AD-01
ISSUE O

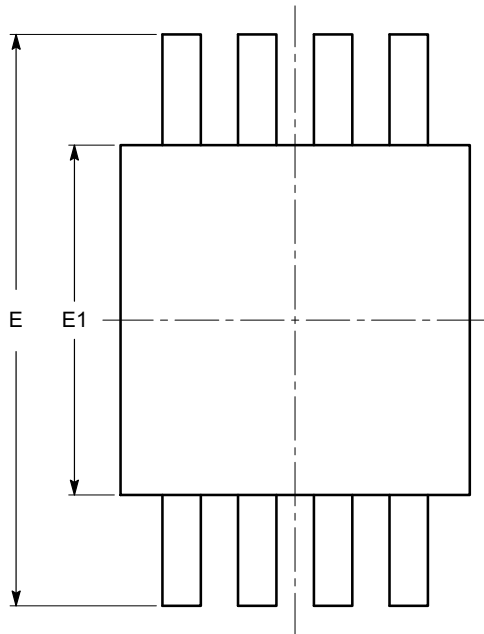

TOP VIEW

SYMBOL	MIN	NOM	MAX
A			1.10
A1	0.05	0.10	0.15
A2	0.75	0.85	0.95
b	0.22		0.38
c	0.13		0.23
D	2.90	3.00	3.10
E	4.80	4.90	5.00
E1	2.90	3.00	3.10
e	0.65 BSC		
L	0.40	0.60	0.80
L1	0.95 REF		
L2	0.25 BSC		
θ	0°		6°

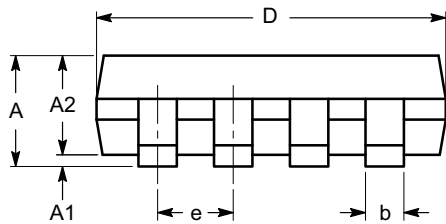

SIDE VIEW

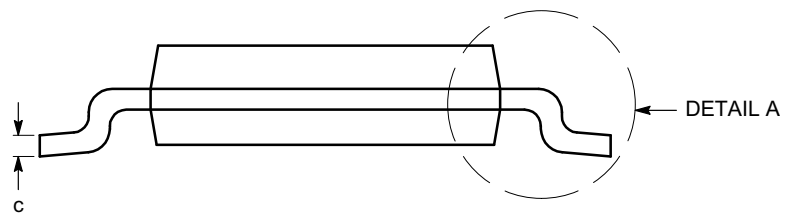

END VIEW

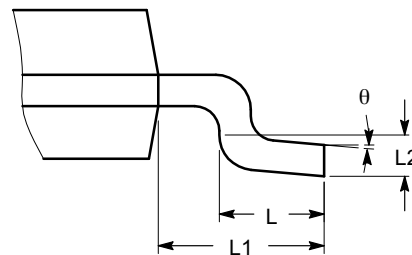

DETAIL A

Notes:

- (1) All dimensions are in millimeters. Angles in degrees.
- (2) Complies with JEDEC MO-187.

ON Semiconductor and  are registered trademarks of Semiconductor Components Industries, LLC (SCILLC). SCILLC reserves the right to make changes without further notice to any products herein. SCILLC makes no warranty, representation or guarantee regarding the suitability of its products for any particular purpose, nor does SCILLC assume any liability arising out of the application or use of any product or circuit, and specifically disclaims any and all liability, including without limitation special, consequential or incidental damages. "Typical" parameters which may be provided in SCILLC data sheets and/or specifications can and do vary in different applications and actual performance may vary over time. All operating parameters, including "Typicals" must be validated for each customer application by customer's technical experts. SCILLC does not convey any license under its patent rights nor the rights of others. SCILLC products are not designed, intended, or authorized for use as components in systems intended for surgical implant into the body, or other applications intended to support or sustain life, or for any other application in which the failure of the SCILLC product could create a situation where personal injury or death may occur. Should Buyer purchase or use SCILLC products for any such unintended or unauthorized application, Buyer shall indemnify and hold SCILLC and its officers, employees, subsidiaries, affiliates, and distributors harmless against all claims, costs, damages, and expenses, and reasonable attorney fees arising out of, directly or indirectly, any claim of personal injury or death associated with such unintended or unauthorized use, even if such claim alleges that SCILLC was negligent regarding the design or manufacture of the part. SCILLC is an Equal Opportunity/Affirmative Action Employer. This literature is subject to all applicable copyright laws and is not for resale in any manner.

PUBLICATION ORDERING INFORMATION

LITERATURE FULFILLMENT:

Literature Distribution Center for ON Semiconductor
P.O. Box 5163, Denver, Colorado 80217 USA
Phone: 303-675-2175 or 800-344-3860 Toll Free USA/Canada
Fax: 303-675-2176 or 800-344-3867 Toll Free USA/Canada
Email: orderlit@onsemi.com

N. American Technical Support: 800-282-9855 Toll Free
USA/Canada
Europe, Middle East and Africa Technical Support:
Phone: 421 33 790 2910
Japan Customer Focus Center
Phone: 81-3-5817-1050

ON Semiconductor Website: www.onsemi.com
Order Literature: <http://www.onsemi.com/orderlit>
For additional information, please contact your local
Sales Representative

Данный компонент на территории Российской Федерации

Вы можете приобрести в компании MosChip.

Для оперативного оформления запроса Вам необходимо перейти по данной ссылке:

<http://moschip.ru/get-element>

Вы можете разместить у нас заказ для любого Вашего проекта, будь то серийное производство или разработка единичного прибора.

В нашем ассортименте представлены ведущие мировые производители активных и пассивных электронных компонентов.

Нашей специализацией является поставка электронной компонентной базы двойного назначения, продукции таких производителей как XILINX, Intel (ex.ALTERA), Vicor, Microchip, Texas Instruments, Analog Devices, Mini-Circuits, Amphenol, Glenair.

Сотрудничество с глобальными дистрибьюторами электронных компонентов, предоставляет возможность заказывать и получать с международных складов практически любой перечень компонентов в оптимальные для Вас сроки.

На всех этапах разработки и производства наши партнеры могут получить квалифицированную поддержку опытных инженеров.

Система менеджмента качества компании отвечает требованиям в соответствии с ГОСТ Р ИСО 9001, ГОСТ РВ 0015-002 и ЭС РД 009

Офис по работе с юридическими лицами:

105318, г.Москва, ул.Щербаковская д.3, офис 1107, 1118, ДЦ «Щербаковский»

Телефон: +7 495 668-12-70 (многоканальный)

Факс: +7 495 668-12-70 (доб.304)

E-mail: info@moschip.ru

Skype отдела продаж:

moschip.ru

moschip.ru_4

moschip.ru_6

moschip.ru_9