



(for DA-Type only)



(for ELG-100-C1050, C1400 only)



(for ELG-100-C1050, 1400 only)



**Features**

- Constant Current mode output
- Metal housing design
- Built-in active PFC function
- No load / Standby power consumption <0.5W
- IP67 / IP65 rating for indoor or outdoor installations
- Function options: output adjustable via potentiometer; 3 in 1 dimming (dim-to-off); Smart timer dimming; DALI
- Typical lifetime>50000 hours
- 5 years warranty

**Applications**

- LED street lighting
- LED harbor lighting
- LED bay lighting
- LED greenhouse lighting
- LED flood lighting
- Type “HL” for use in Class I, Division 2 hazardous (Classified) location.

**Description**

ELG-100-C series is a 100W LED AC/DC power supply featuring the constant current mode and high voltage output. ELG-100-C operates from 100~305VAC and offers models with different rated current ranging between 350mA and 1400mA. Thanks to the high efficiency up to 92%, with the fanless design, the entire series is able to operate for -40°C~+90°C case temperature under free air convection. The design of metal housing and IP67/IP65 ingress protection level allows this series to fit both indoor and outdoor applications. ELG-100-C is equipped with various function options, such as dimming methodologies, so as to provide the optimal design flexibility for LED lighting system.

**Model Encoding**

**ELG - 100 - C500 A**

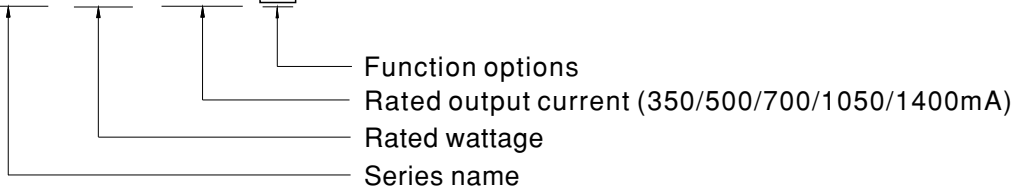

| Type  | IP Level | Function   | Note       |
|-------|----------|--|------------|
| Blank | IP67     | Io fixed.  | In Stock   |
| A     | IP65     | Io adjustable through built-in potentiometer.                    | In Stock   |
| B     | IP67     | 3 in 1 dimming function (0~10Vdc, 10V PWM signal and resistance) | In Stock   |
| DA    | IP67     | DALI control technology.   | In Stock   |
| Dx    | IP67     | Built-in Smart timer dimming function by user request.           | By request |
| D2    | IP67     | Built-in Smart timer dimming and programmable function.          | In Stock   |



**SPECIFICATION**

| MODEL                             |  | ELG-100-C350 □   | ELG-100-C500 □ | ELG-100-C700 □ | ELG-100-C1050□ | ELG-100-C1400□ |
|-----------------------------------|--|--|----------------|----------------|----------------|----------------|
| OUTPUT                            | RATED CURRENT  | 350mA  | 500mA          | 700mA          | 1050mA         | 1400mA         |
|                                   | RATED POWER  | 100.1W   | 100W           | 100.1W         | 99.75W         | 100.8W         |
|                                   | CONSTANT CURRENT REGION <small>Note.2</small>  | 143 ~ 286V   | 100 ~ 200V     | 71 ~ 143V      | 48 ~ 95V       | 35 ~ 72V       |
|                                   | OPEN CIRCUIT VOLTAGE <sub>(max.)</sub>   | 297V   | 210V           | 149V           | 105V           | 75V            |
|                                   | CURRENT ADJ. RANGE   | Adjustable for A-Type only (via built-in potentiometer)  |                |                |                |                |
|                                   |  | 175 ~ 350mA  | 250 ~ 500mA    | 350 ~ 700mA    | 525 ~ 1050mA   | 700 ~ 1400mA   |
|                                   | CURRENT RIPPLE   | 5.0% max. @rated current   |                |                |                |                |
|                                   | CURRENT TOLERANCE  | ±5.0%  |                |                |                |                |
| SET UP TIME <small>Note.4</small> | 1000ms/115VAC  | 500ms/230VAC   |                |                |                |                |
| INPUT                             | VOLTAGE RANGE <small>Note.3</small>  | 100 ~ 305VAC 142 ~ 431VDC<br>(Please refer to "STATIC CHARACTERISTIC" section)   |                |                |                |                |
|                                   | FREQUENCY RANGE  | 47 ~ 63Hz  |                |                |                |                |
|                                   | POWER FACTOR (Typ.)  | PF ≥ 0.97/115VAC, PF ≥ 0.95/230VAC, PF ≥ 0.92/277VAC@full load<br>(Please refer to "POWER FACTOR (PF) CHARACTERISTIC" section)       |                |                |                |                |
|                                   | TOTAL HARMONIC DISTORTION  | THD < 20% (@load ≥ 50%/115VAC; @load ≥ 60%/230VAC; @load ≥ 75%/277VAC)<br>(Please refer to "TOTAL HARMONIC DISTORTION(THD)" section) |                |                |                |                |
|                                   | EFFICIENCY (Typ.)  | 92%  | 91%            | 90%            | 90%            | 90%            |
|                                   | AC CURRENT (Typ.)  | 1.1A / 115VAC 0.6A / 230VAC 0.5A/277VAC  |                |                |                |                |
|                                   | INRUSH CURRENT(Typ.)   | COLD START 40A(twidth=760μs measured at 50% Ipeak)/230VAC; Per NEMA 410  |                |                |                |                |
|                                   | MAX. No. of PSUs on 16A CIRCUIT BREAKER  | 3 units (circuit breaker of type B) / 6 units (circuit breaker of type C) at 230VAC  |                |                |                |                |
|                                   | LEAKAGE CURRENT  | <0.75mA / 277VAC   |                |                |                |                |
|                                   | NO LOAD / STANDBY POWER CONSUMPTION  | No load power consumption <0.5W for Blank / A / Dx / D2-Type<br>Standby power consumption <0.5W for B / DA-Type                      |                |                |                |                |
| PROTECTION                        | SHORT CIRCUIT  | Hiccup mode, recovers automatically after fault condition is removed   |                |                |                |                |
|                                   | OVER VOLTAGE   | 305 ~ 333V   | 222 ~ 242V     | 154 ~ 174V     | 110 ~ 130V     | 79 ~ 95V       |
|                                   | OVER TEMPERATURE   | Shut down o/p voltage, re-power on to recover  |                |                |                |                |
| ENVIRONMENT                       | WORKING TEMP.  | Tcase=-40 ~ +90°C (Please refer to " OUTPUT LOAD vs TEMPERATURE" section)  |                |                |                |                |
|                                   | MAX. CASE TEMP.  | Tcase=+90°C  |                |                |                |                |
|                                   | WORKING HUMIDITY   | 20 ~ 95% RH non-condensing   |                |                |                |                |
|                                   | STORAGE TEMP., HUMIDITY  | -40 ~ +80°C, 10 ~ 95% RH   |                |                |                |                |
|                                   | TEMP. COEFFICIENT  | ±0.03%/°C (0 ~ 60°C)   |                |                |                |                |
|                                   | VIBRATION  | 10 ~ 500Hz, 5G 12min./1cycle, period for 72min. each along X, Y, Z axes  |                |                |                |                |
| SAFETY & EMC                      | SAFETY STANDARDS <small>Note.6</small>   | UL8750(type"HL"), CSA C22.2 No. 250.13-12; ENEC EN61347-1, EN61347-2-13 independent, EN62384; IP65 or IP67 approved                  |                |                |                |                |
|                                   | WITHSTAND VOLTAGE  | I/P-O/P:3.75KVAC I/P-FG:2.0KVAC O/P-FG:1.5KVAC   |                |                |                |                |
|                                   | ISOLATION RESISTANCE   | I/P-O/P, I/P-FG, O/P-FG:100M Ohms / 500VDC / 25°C / 70% RH   |                |                |                |                |
|                                   | EMC EMISSION <small>Note.6</small>   | Compliance to EN55015,EN61000-3-2 Class C (@ load ≥ 60%) ; EN61000-3-3   |                |                |                |                |
|                                   | EMC IMMUNITY   | Compliance to EN61000-4-2,3,4,5,6,8,11; EN61547, light industry level (surge immunity Line-Earth 6KV, Line-Line 4KV)                 |                |                |                |                |
| OTHERS                            | MTBF   | 300.6Khrs min. MIL-HDBK-217F (25°C)  |                |                |                |                |
|                                   | DIMENSION  | 199*63*35.5 mm (L*W*H)   |                |                |                |                |
|                                   | PACKING  | 0.75kg; 16pcs/13kg/0.72CUFT  |                |                |                |                |
| NOTE                              | <ol style="list-style-type: none"> <li>All parameters NOT specially mentioned are measured at 230VAC input, rated current and 25°C of ambient temperature.</li> <li>Please refer to "DRIVING METHODS OF LED MODULE". For DA-Type, Constant Current region is 60%~100% of maximum voltage under rated power delivery.</li> <li>De-rating may be needed under low input voltages. Please refer to "STATIC CHARACTERISTIC" sections for details.</li> <li>Length of set up time is measured at first cold start. Turning ON/OFF the power supply may lead to increase of the set up time.</li> <li>The driver is considered as a component that will be operated in combination with final equipment. Since EMC performance will be affected by the complete installation, the final equipment manufacturers must re-qualify EMC Directive on the complete installation again.</li> <li>The model certified for CCC(GB19510.14, GB19510.1, GB17743 and GB17625.1) is an optional model . Please contact MEAN WELL for details.</li> <li>This series meets the typical life expectancy of &gt;50,000 hours of operation when Tcase, particularly (Tc) point (or TMP, per DLC), is about 80°C or less.</li> <li>Please refer to the warranty statement on MEAN WELL'S website at <a href="http://www.meanwell.com">http://www.meanwell.com</a></li> </ol> |  |                |                |                |                |

■ BLOCK DIAGRAM

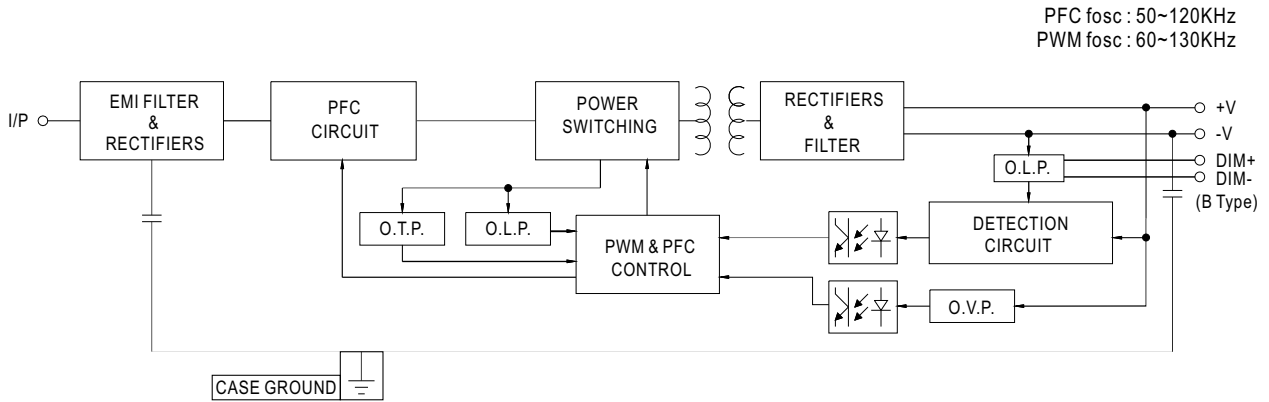

■ DRIVING METHODS OF LED MODULE

※ This series works in constant current mode to directly drive the LEDs.

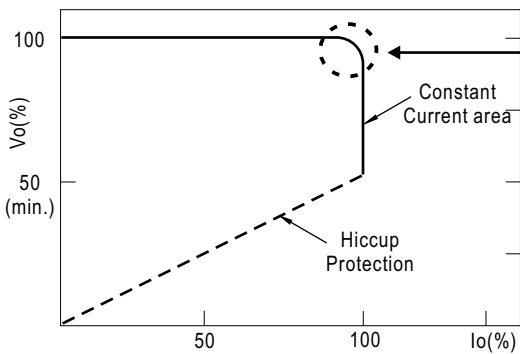

Typical output current normalized by rated current (%)

In the constant current region, the highest voltage at the output of the driver depends on the configuration of the end systems.  
Should there be any compatibility issues, please contact MEAN WELL.

© This characteristic applies to Blank/A/B/DX/D2-Type,  
For DA-Type, the Constant Current area is 60%~100% Vo.

## ■ DIMMING OPERATION

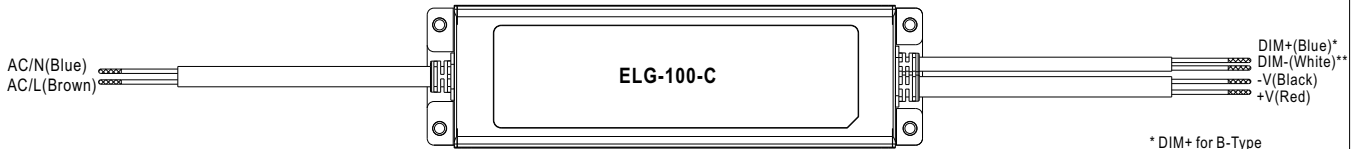

\* DIM+ for B-Type  
DA+ for DA-Type  
PROG+ for D2-Type  
\*\* DIM- for B-Type  
DA- for DA-Type  
PROG- for D2-Type

### ※ 3 in 1 dimming function (for B-Type)

- Output constant current level can be adjusted by applying one of the three methodologies between DIM+ and DIM-:  
0 ~ 10VDC, or 10V PWM signal or resistance.
- Direct connecting to LEDs is suggested. It is not suitable to be used with additional drivers.
- Dimming source current from power supply: 100 $\mu$ A (typ.)

#### ◎ Applying additive 0 ~ 10VDC

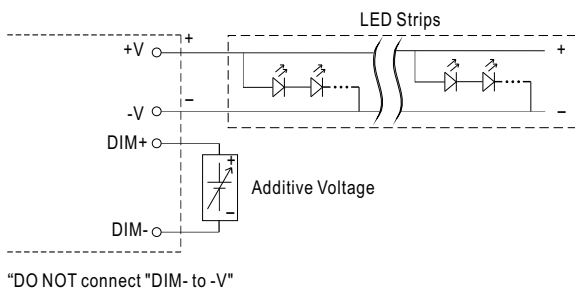

#### ◎ Applying additive 10V PWM signal (frequency range 100Hz ~ 3KHz):

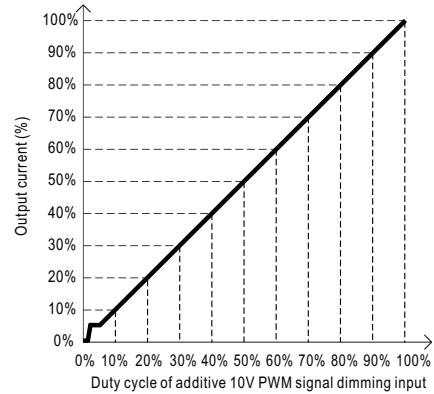
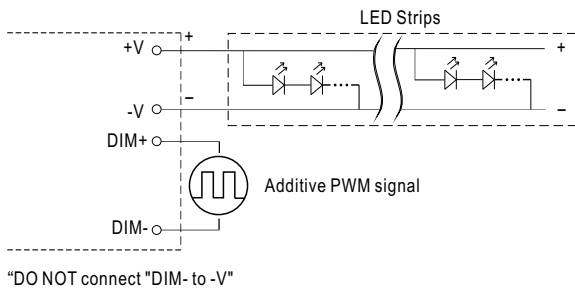

#### ◎ Applying additive resistance:

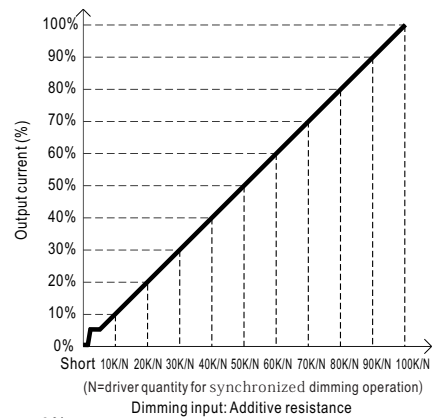
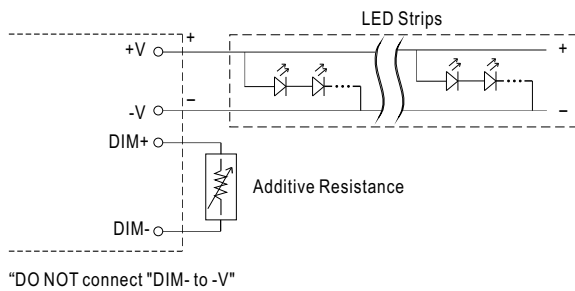

Note : 1. Min. dimming level is about 8% and the output current is not defined when 0% < I<sub>out</sub> < 8%.  
2. The output current could drop down to 0% when dimming input is about 0k $\Omega$  or 0Vdc, or 10V PWM signal with 0% duty cycle.

※ **DALI Interface (primary side; for DA-Type)**

- Apply DALI signal between DA+ and DA-.
- DALI protocol comprises 16 groups and 64 addresses.
- First step is fixed at 8% of output.

※ **Smart timer dimming function (for Dxx-Type by User definition)**

MEAN WELL Smart timer dimming primarily provides the adaptive proportion dimming profile for the output constant current level to perform up to 14 consecutive hours. 3 dimming profiles hereunder are defined accounting for the most frequently seen applications. If other options may be needed, please contact MEAN WELL for details.

Ex : ☉ D01-Type: the profile recommended for residential lighting



Set up for D01-Type in Smart timer dimming software program:

|         | T1    | T2    | T3    | T4  |
|---------|-------|-------|-------|-----|
| TIME**  | 06:00 | 07:00 | 11:00 | --- |
| LEVEL** | 100%  | 70%   | 50%   | 70% |

\*\* : TIME matches Operating Time in the diagram whereas LEVEL matches Dimming Level.

Example: If a residential lighting application adopts D01-Type, when turning on the power supply at 6:00pm, for instance:

- [1] The power supply will switch to the constant current level at 100% starting from 6:00pm.
- [2] The power supply will switch to the constant current level at 70% in turn, starting from 0:00am, which is 06:00 after the power supply turns on.
- [3] The power supply will switch to the constant current level at 50% in turn, starting from 1:00am, which is 07:00 after the power supply turns on.
- [4] The power supply will switch to the constant current level at 70% in turn, starting from 5:00am, which is 11:00 after the power supply turns on.

The constant current level remains till 8:00am, which is 14:00 after the power supply turns on.

Ex : ☉ D02-Type: the profile recommended for street lighting

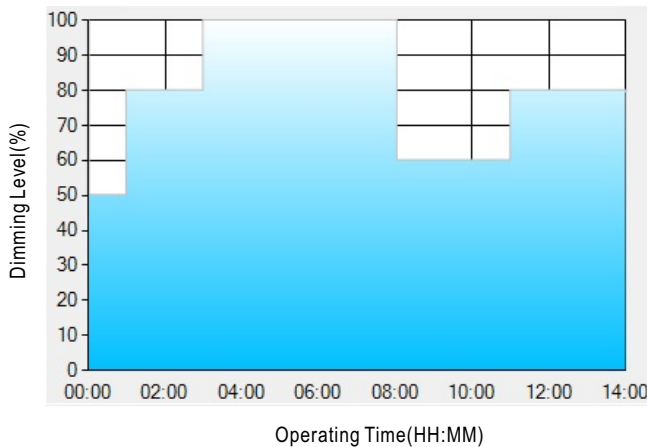

Set up for D02-Type in Smart timer dimming software program:

|         | T1    | T2    | T3   | T4    | T5  |
|---------|-------|-------|------|-------|-----|
| TIME**  | 01:00 | 03:00 | 8:00 | 11:00 | --- |
| LEVEL** | 50%   | 80%   | 100% | 60%   | 80% |

\*\* : TIME matches Operating Time in the diagram whereas LEVEL matches Dimming Level.

Example: If a street lighting application adopts D02-Type, when turning on the power supply at 5:00pm, for instance:

- [1] The power supply will switch to the constant current level at 50% starting from 5:00pm.
- [2] The power supply will switch to the constant current level at 80% in turn, starting from 6:00pm, which is 01:00 after the power supply turns on.
- [3] The power supply will switch to the constant current level at 100% in turn, starting from 8:00pm, which is 03:00 after the power supply turns on.
- [4] The power supply will switch to the constant current level at 60% in turn, starting from 1:00am, which is 08:00 after the power supply turns on.
- [5] The power supply will switch to the constant current level at 80% in turn, starting from 4:00am, which is 11:00 after the power supply turns on. The constant current level remains till 6:30am, which is 14:00 after the power supply turns on.

Ex: © D03-Type: the profile recommended for tunnel lighting

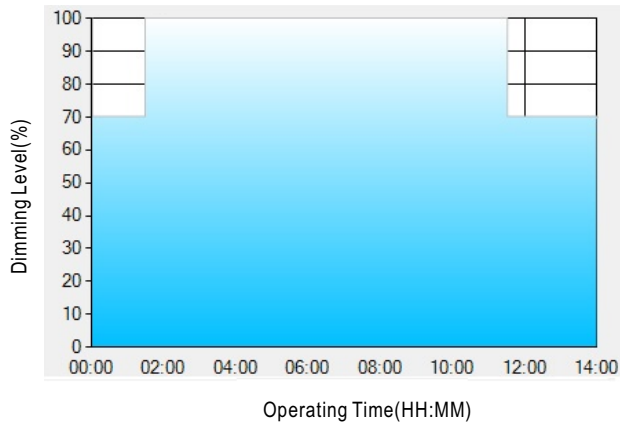

Set up for D03-Type in Smart timer dimming software program:

|         | T1    | T2    | T3  |
|---------|-------|-------|-----|
| TIME**  | 01:30 | 11:00 | --- |
| LEVEL** | 70%   | 100%  | 70% |

\*\* : TIME matches Operating Time in the diagram whereas LEVEL matches Dimming Level.

Example: If a tunnel lighting application adopts D03-Type, when turning on the power supply at 4:30pm, for instance:

[1] The power supply will switch to the constant current level at 70% starting from 4:30pm.

[2] The power supply will switch to the constant current level at 100% in turn, starting from 6:00pm, which is 01:30 after the power supply turns on.

[3] The power supply will switch to the constant current level at 70% in turn, starting from 5:00am, which is 11:00 after the power supply turns on.

The constant current level remains till 6:30am, which is 14:00 after the power supply turns on.

**OUTPUT LOAD vs TEMPERATURE**

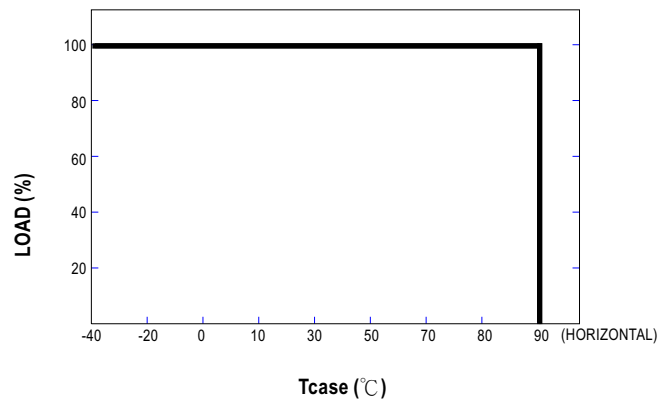
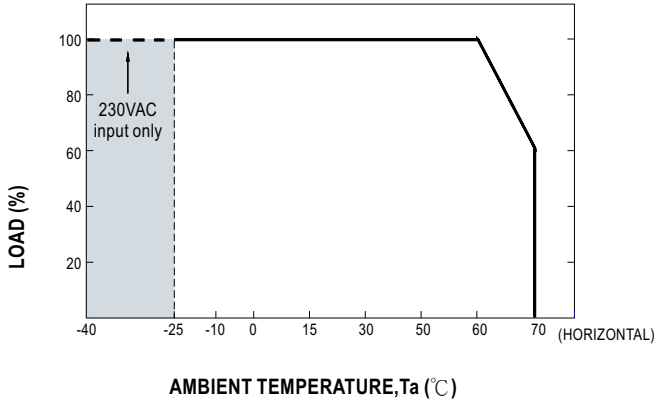

**STATIC CHARACTERISTIC**

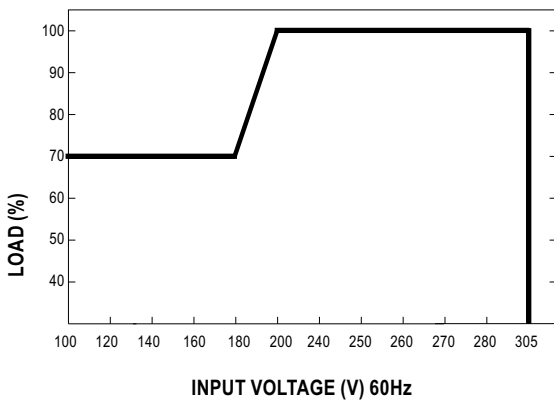

※ De-rating is needed under low input voltage.

**POWER FACTOR (PF) CHARACTERISTIC**

※ Tcase at 80°C

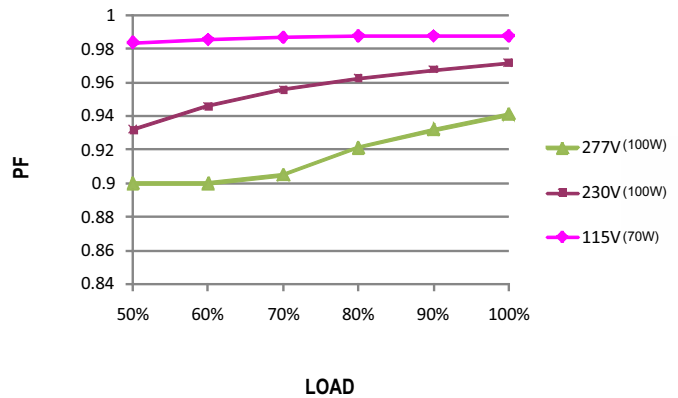

**TOTAL HARMONIC DISTORTION (THD)**

※ 350mA Model, Tcase at 80°C

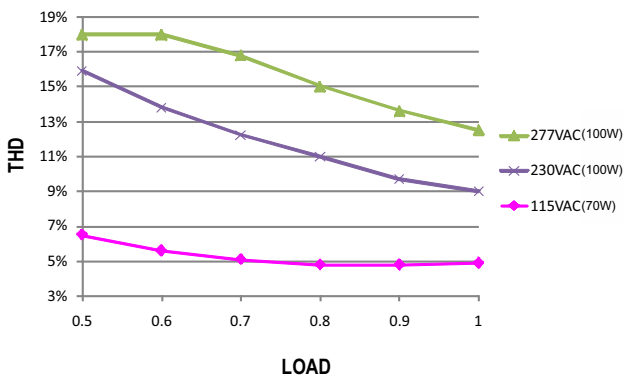

**EFFICIENCY vs LOAD**

ELG-100-C series possess superior working efficiency that up to 92% can be reached in field applications.

※ 350mA Model, Tcase at 80°C

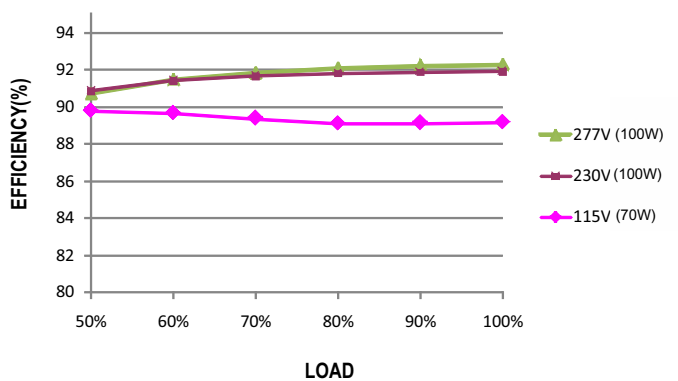

■ LIFE TIME

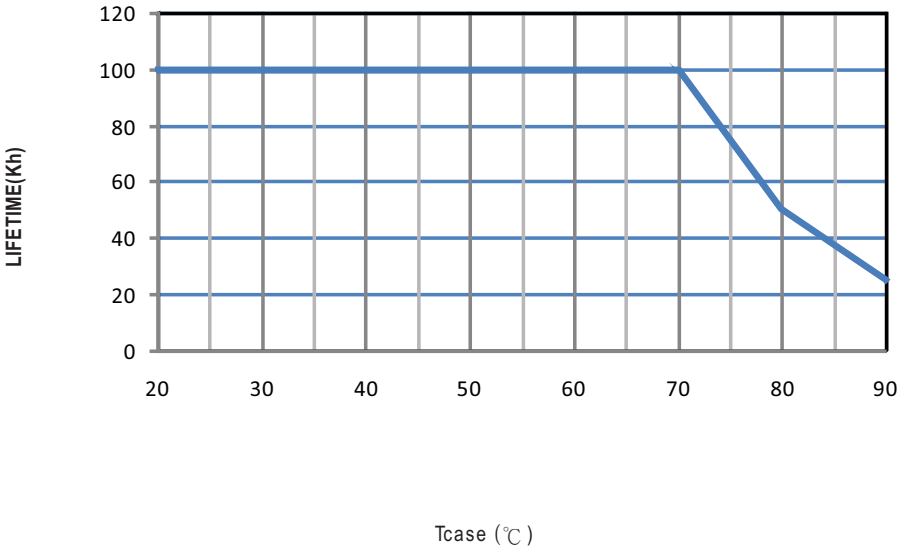



MECHANICAL SPECIFICATION

※ Blank-Type

CASE NO.: 244A Unit:mm

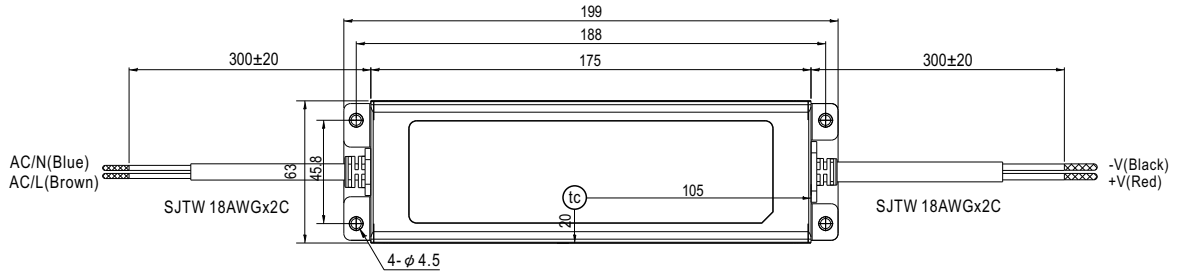

•  $t_c$  : Max. Case Temperature



※ A-Type

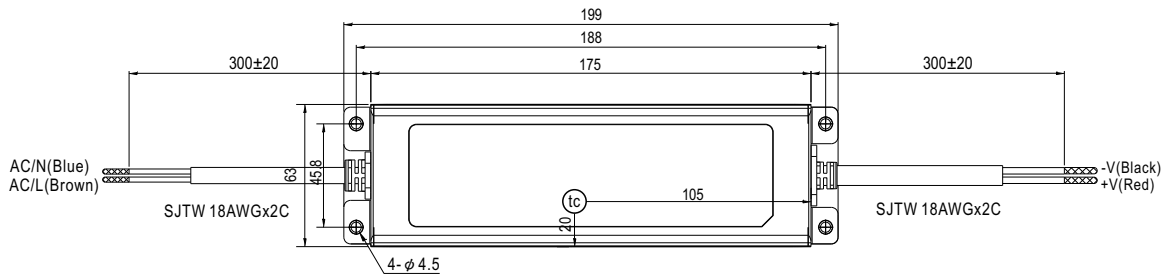

•  $t_c$  : Max. Case Temperature

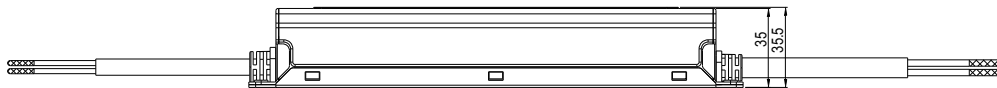

※ B/DA/D2-Type

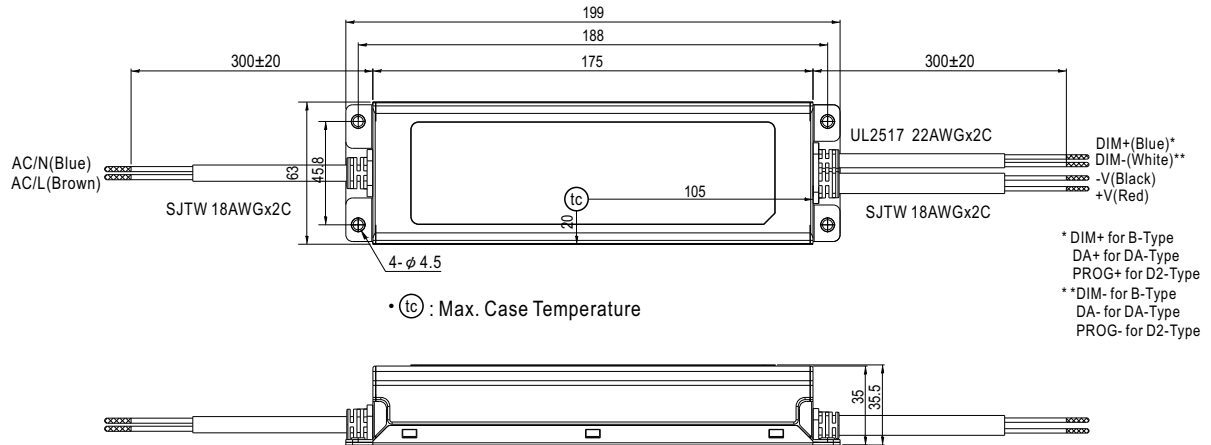

- Note1: Please connect the case to FG for the complete EMC deliverance.
- Note2: Please contact MEAN WELL for input wiring option with FG.

**■ INSTALLATION MANUAL**

Please refer to : <http://www.meanwell.com/webnet/search/InstallationSearch.html>

## Данный компонент на территории Российской Федерации

### Вы можете приобрести в компании MosChip.

Для оперативного оформления запроса Вам необходимо перейти по данной ссылке:

<http://moschip.ru/get-element>

Вы можете разместить у нас заказ для любого Вашего проекта, будь то серийное производство или разработка единичного прибора.

В нашем ассортименте представлены ведущие мировые производители активных и пассивных электронных компонентов.

Нашей специализацией является поставка электронной компонентной базы двойного назначения, продукции таких производителей как XILINX, Intel (ex.ALTERA), Vicor, Microchip, Texas Instruments, Analog Devices, Mini-Circuits, Amphenol, Glenair.

Сотрудничество с глобальными дистрибьюторами электронных компонентов, предоставляет возможность заказывать и получать с международных складов практически любой перечень компонентов в оптимальные для Вас сроки.

На всех этапах разработки и производства наши партнеры могут получить квалифицированную поддержку опытных инженеров.

Система менеджмента качества компании отвечает требованиям в соответствии с ГОСТ Р ИСО 9001, ГОСТ РВ 0015-002 и ЭС РД 009

### Офис по работе с юридическими лицами:

105318, г.Москва, ул.Щербаковская д.3, офис 1107, 1118, ДЦ «Щербаковский»

Телефон: +7 495 668-12-70 (многоканальный)

Факс: +7 495 668-12-70 (доб.304)

E-mail: [info@moschip.ru](mailto:info@moschip.ru)

Skype отдела продаж:

moschip.ru

moschip.ru\_4

moschip.ru\_6

moschip.ru\_9