

## Optocoupler, Phototriac Output, 400 V<sub>DRM</sub>

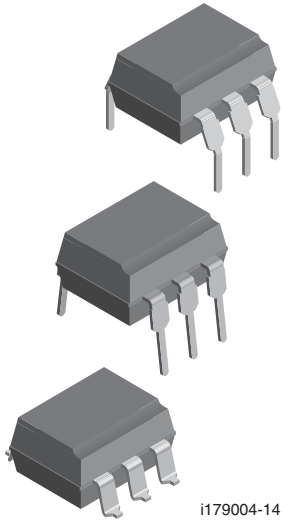

i179004-14

Note: pin 5 must not be connected

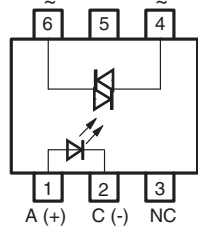

### FEATURES

- 400 V blocking voltage
- Isolation test voltage, 5000 V<sub>RMS</sub>, t = 1 min
- Material categorization: for definitions of compliance please see [www.vishay.com/doc?99912](http://www.vishay.com/doc?99912)



RoHS COMPLIANT

### APPLICATIONS

- High current triac driver
- Solid-state relay
- Switch small AC loads

### AGENCY APPROVALS

(all parts are certified under base model VO3020)

- UL1577, file no. E52744 double protection
- cUL tested to CSA 22.2 bulletin 5A
- DIN EN 60747-5-5 (VDE 0884-5), available with option 1
- FIMKO EN 60950-1
- CQC GB8898-2011, GB4943.1-2011

### DESCRIPTION

The VO3020 series consists of a phototriac optically coupled to a gallium arsenide infrared-emitting diode in a 6-lead plastic dual inline package

| ORDERING INFORMATION  |  |                                  |                |              |              |
|---|--|----------------------------------|----------------|--------------|--------------|
| <div style="display: flex; justify-content: space-around; align-items: center;"> <div style="border: 1px solid black; padding: 2px;">V</div> <div style="border: 1px solid black; padding: 2px;">O</div> <div style="border: 1px solid black; padding: 2px;">3</div> <div style="border: 1px solid black; padding: 2px;">0</div> <div style="border: 1px solid black; padding: 2px;">2</div> <div style="border: 1px solid black; padding: 2px;">#</div> <div style="border: 1px solid black; padding: 2px;">-</div> <div style="border: 1px solid black; padding: 2px;">X</div> <div style="border: 1px solid black; padding: 2px;">0</div> <div style="border: 1px solid black; padding: 2px;">0</div> <div style="border: 1px solid black; padding: 2px;">#</div> <div style="border: 1px solid black; padding: 2px;">T</div> </div> |  |                                  |                |              |              |
| PART NUMBER   |  |                                  | PACKAGE OPTION |              |              |
|   |  |                                  | TAPE AND REEL  |              |              |
|   |  |                                  |                |              |              |
| AGENCY CERTIFIED / PACKAGE  |  | TRIGGER CURRENT, I <sub>FT</sub> |                |              |              |
| UL, cUL, CQC  |  | 5 mA                             | 10 mA          | 15 mA        | 30 mA        |
| DIP-6   |  | VO3023                           | VO3022         | VO3021       | VO3020       |
| DIP-6, 400 mil, option 6  |  | VO3023-X006                      | VO3022-X006    | VO3021-X006  | VO3020-X006  |
| SMD-6, option 7   |  | VO3023-X007T                     | VO3022-X007T   | VO3021-X007T | VO3020-X007T |
| VDE, UL, cUL, FIMKO, CQC  |  | 5 mA                             | 10 mA          | 15 mA        | 30 mA        |
| DIP-6   |  | VO3023-X001                      | VO3022-X001    | VO3021-X001  | VO3020-X001  |
| SMD-6, option 7   |  | VO3023-X017T                     | -              | VO3021-X017T | VO3020-X017T |

### Note

- Additional options may be possible, please contact sales office



| ABSOLUTE MAXIMUM RATINGS (T <sub>amb</sub> = 25 °C, unless otherwise specified) |                          |                     |             |                  |
|---|--------------------------|---------------------|-------------|------------------|
| PARAMETER   | TEST CONDITION           | SYMBOL              | VALUE       | UNIT             |
| <b>INPUT</b>  |                          |                     |             |                  |
| Reverse voltage   |                          | V <sub>R</sub>      | 6           | V                |
| Forward current   |                          | I <sub>F</sub>      | 50          | mA               |
| Peak surge current  | 100 μs, 200 pps          | I <sub>FSM</sub>    | 0.5         | A                |
| Power dissipation   |                          | P <sub>diss</sub>   | 70          | mW               |
| <b>OUTPUT</b>   |                          |                     |             |                  |
| Peak off-state voltage  |                          | V <sub>DRM</sub>    | 400         | V                |
| RMS on-state current  |                          | I <sub>T(RMS)</sub> | 0.1         | A                |
| Peak non-repetitive surge current   | PW = 100 ms, 120 pps     | I <sub>TSM</sub>    | 1           | A                |
| Power dissipation   |                          | P <sub>diss</sub>   | 300         | mW               |
| <b>COUPLER</b>  |                          |                     |             |                  |
| Isolation voltage   | t = 1 min                | V <sub>ISO</sub>    | 5000        | V <sub>RMS</sub> |
| Total power dissipation   |                          | P <sub>tot</sub>    | 330         | mW               |
| Storage temperature range   |                          | T <sub>stg</sub>    | -55 to +150 | °C               |
| Ambient temperature   |                          | T <sub>amb</sub>    | -40 to +100 | °C               |
| Lead soldering temperature <sup>(1)</sup>                                       | 2 mm from case, t < 10 s | T <sub>slid</sub>   | 260         | °C               |
| Junction temperature  |                          | T <sub>j</sub>      | 125         | °C               |

Notes

- Stresses in excess of the absolute maximum ratings can cause permanent damage to the device. Functional operation of the device is not implied at these or any other conditions in excess of those given in the operational sections of this document. Exposure to absolute maximum ratings for extended periods of the time can adversely affect reliability.
- <sup>(1)</sup> Refer to reflow profile for soldering conditions for surface mounted devices (SMD). Refer to wave profile for soldering conditions for through hole devices (DIP)

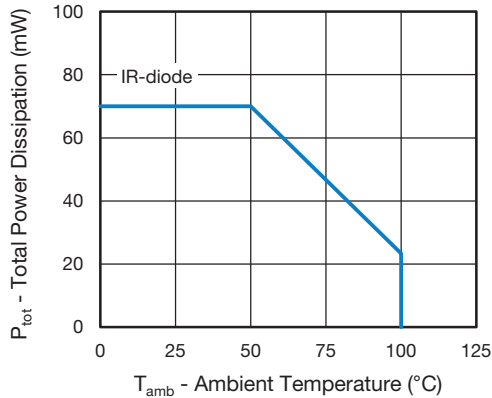

Fig. 1 - Total Power Dissipation vs. Ambient Temperature (IR-Diode)

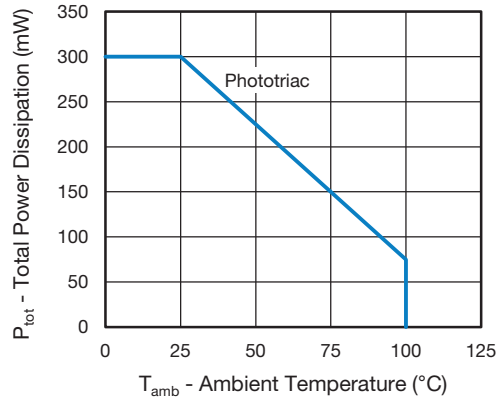

Fig. 2 - Total Power Dissipation vs. Ambient Temperature (Phototriac)



| <b>ELECTRICAL CHARACTERISTICS</b> ( $T_{amb} = 25\text{ }^{\circ}\text{C}$ , unless otherwise specified) |  |        |              |      |      |      |                  |
|--|--|--------|--------------|------|------|------|------------------|
| PARAMETER  | TEST CONDITION                                   | PART   | SYMBOL       | MIN. | TYP. | MAX. | UNIT             |
| <b>INPUT</b>   |  |        |              |      |      |      |                  |
| Forward voltage  | $I_F = 20\text{ mA}$                             |        | $V_F$        | -    | 1.3  | 1.5  | V                |
| Reverse voltage  | $I_R = 10\text{ }\mu\text{A}$                    |        | $V_R$        | 6    | -    | -    | V                |
| Reverse current  | $V_R = 6\text{ V}$                               |        | $I_R$        | -    | -    | 10   | $\mu\text{A}$    |
| Junction capacitance   | $V_R = 0\text{ V}$ , $f = 1\text{ MHz}$          |        | $C_j$        | -    | 50   | -    | pF               |
| <b>OUTPUT</b>  |  |        |              |      |      |      |                  |
| Peak off-state current, either direction   | $V_{DRM} = 400\text{ V}^{(1)}$                   |        | $I_{DRM}$    | -    | 10   | 100  | nA               |
| Peak off-state voltage, either direction   | $I_{TM} = 100\text{ mA}$                         |        | $V_{TM}$     | -    | 1.7  | 3    | V                |
| Critical rate of rise of off-state voltage   | $I_F = 0\text{ A}$ , $V_D = 0.67\text{ }V_{DRM}$ |        | $dV/dt_{cr}$ | 100  | -    | -    | V/ $\mu\text{s}$ |
| <b>COUPLER</b> <sup>(2)</sup>  |  |        |              |      |      |      |                  |
| Emitting diode trigger current   | $V_S = 3\text{ V}$ , $R_L = 150\text{ }\Omega$   | VO3020 | $I_{FT}$     | -    | 15   | 30   | mA               |
|  |  | VO3021 | $I_{FT}$     | -    | 8    | 15   | mA               |
|  |  | VO3022 | $I_{FT}$     | -    | 5    | 10   | mA               |
|  |  | VO3023 | $I_{FT}$     | -    | 3    | 5    | mA               |
| Holding current  | $I_F = 10\text{ mA}$ , $V_S \geq 3\text{ V}$     |        | $I_H$        | -    | 200  | -    | $\mu\text{A}$    |

**Notes**

- Minimum and maximum values are testing requirements. Typical values are characteristics of the device and are the result of engineering evaluation. Typical values are for information only and are not part of the testing requirements
- (1) Test voltage must be applied within dV/dt ratings
- (2)  $I_{FT}$  is defined as a minimum trigger current

| <b>SAFETY AND INSULATION RATINGS</b>                         |   |            |                     |                    |
|--|---|------------|---------------------|--------------------|
| PARAMETER  |   | SYMBOL     | VALUE               | UNIT               |
| <b>MAXIMUM SAFETY RATINGS</b>                                |   |            |                     |                    |
| Output safety power  |   | $P_{SO}$   | 700                 | mW                 |
| Input safety current   |   | $I_{si}$   | 400                 | mA                 |
| Safety temperature   |   | $T_S$      | 175                 | $^{\circ}\text{C}$ |
| Comparative tracking index                                   |   | CTI        | 175                 |                    |
| <b>INSULATION RATED PARAMETERS</b>                           |   |            |                     |                    |
| Maximum withstanding isolation voltage                       |   | $V_{ISO}$  | 5000                | $V_{RMS}$          |
| Maximum transient isolation voltage                          |   | $V_{IOTM}$ | 8000                | $V_{peak}$         |
| Maximum repetitive peak isolation voltage                    |   | $V_{IORM}$ | 890                 | $V_{peak}$         |
|  |   | $V_{IORM}$ | 1140 <sup>(1)</sup> | $V_{peak}$         |
| Insulation resistance  | $T_{amb} = 25\text{ }^{\circ}\text{C}$ , $V_{DC} = 500\text{ V}$  | $R_{IO}$   | $10^{12}$           | $\Omega$           |
| Isolation resistance   | $T_{amb} = 100\text{ }^{\circ}\text{C}$ , $V_{DC} = 500\text{ V}$ | $R_{IO}$   | $10^{11}$           | $\Omega$           |
| Climatic classification (according to IEC 68 part 1)         |   |            | 55 / 115 / 21       |                    |
| Environment (pollution degree in accordance to DIN VDE 0109) |   |            | 2                   |                    |
| Creepage distance (standard DIP-6)                           |   |            | $\geq 7$            | mm                 |
| Creepage distance (400 mil DIP-6)                            |   |            | $\geq 8$            | mm                 |
| Clearance distance (standard DIP-6)                          |   |            | $\geq 7$            | mm                 |
| Clearance distance (400 mil DIP-6)                           |   |            | $\geq 8$            | mm                 |
| Insulation thickness   |   |            | $\geq 0.4$          | mm                 |

**Notes**

- As per DIN EN 60747-5-5, § 7.4.3.8.2, this optocoupler is suitable for “safe electrical insulation” only within the safety ratings. Compliance with the safety ratings shall be ensured by means of protective circuits
- (1) 400 mil, option 6 only



TYPICAL CHARACTERISTICS (T<sub>amb</sub> = 25 °C, unless otherwise specified)

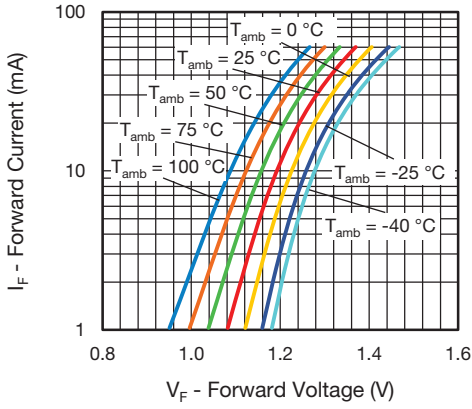

Fig. 3 - Forward Current vs. Forward Voltage

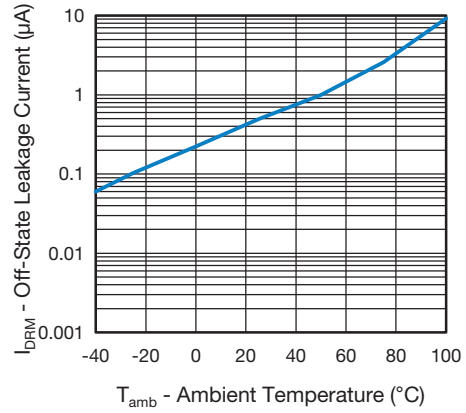

Fig. 6 - Off-State Leakage Current vs. Ambient Temperature

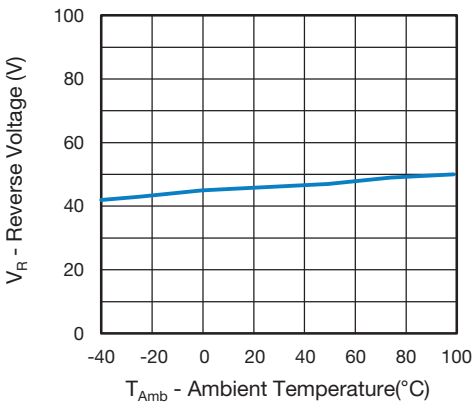

Fig. 4 - Reverse Voltage vs. Ambient Temperature

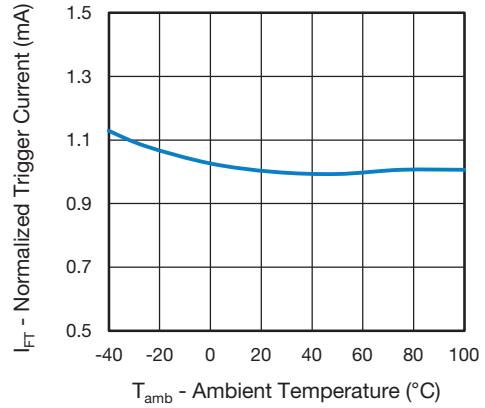

Fig. 7 - Normalized Trigger Current vs. Ambient Temperature

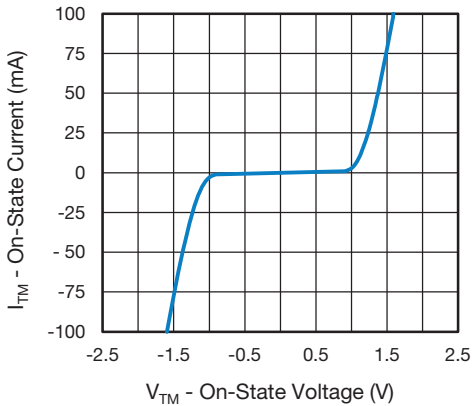

Fig. 5 - On-State Current vs. On-State Voltage

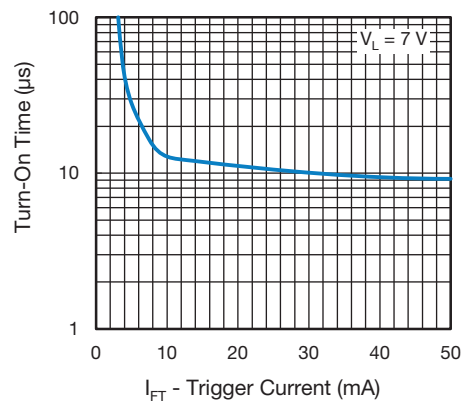

Fig. 8 - Turn-On Time vs. Trigger Current

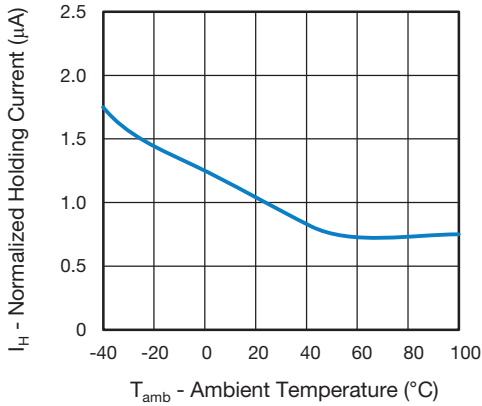

Fig. 9 - Normalized Holding Current vs. Ambient Temperature

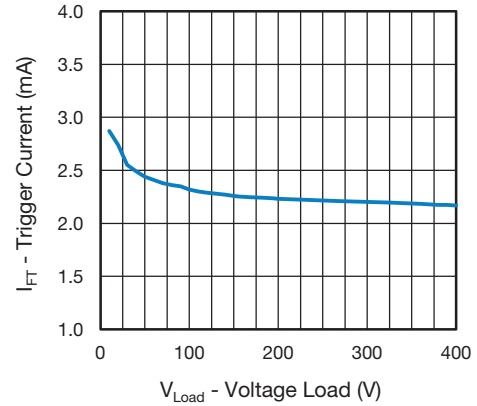

Fig. 12 - Trigger Current vs. Voltage Load

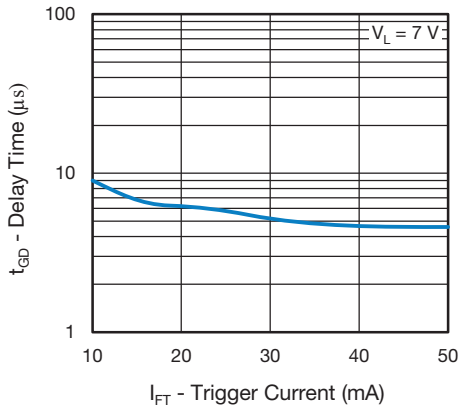

Fig. 10 - Delay Time vs. Trigger Current

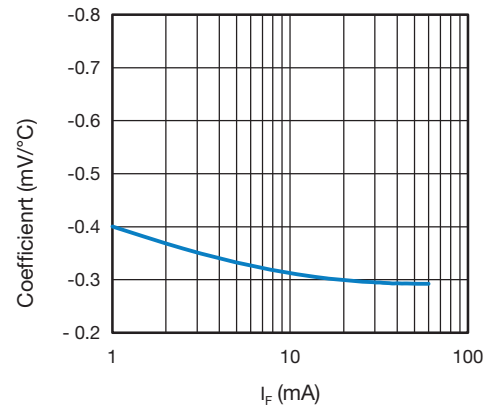

Fig. 13 - Coefficient vs. Forward Current

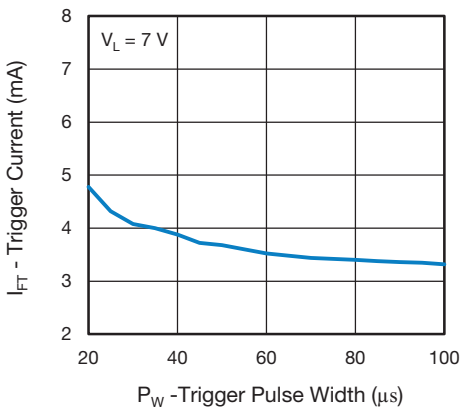

Fig. 11 - Trigger Current vs. Trigger Pulse Width

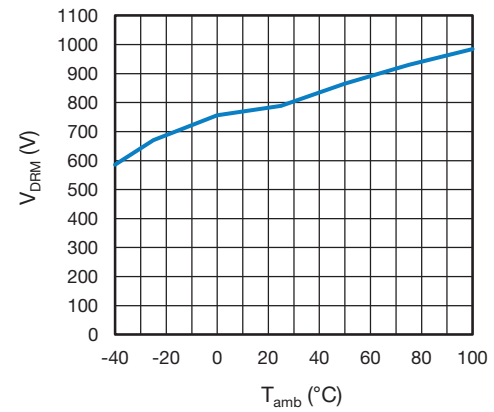

Fig. 14 - Peak Off-State Voltage vs. Ambient Temperature

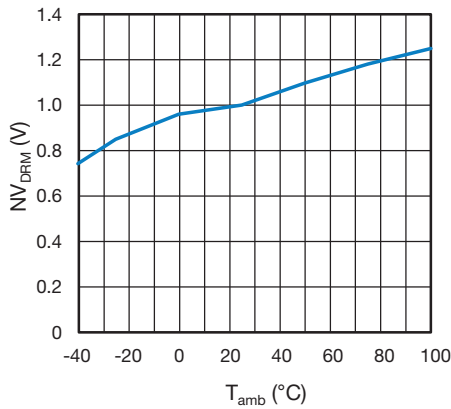
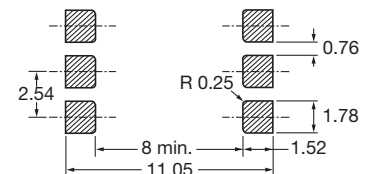
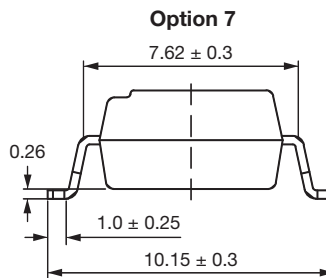
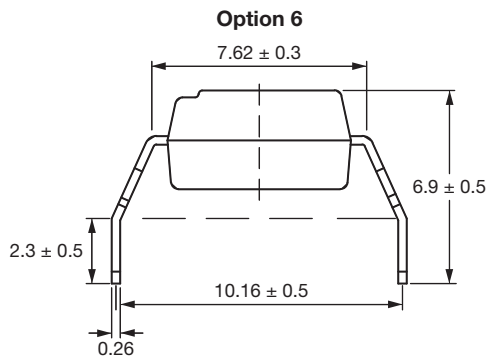
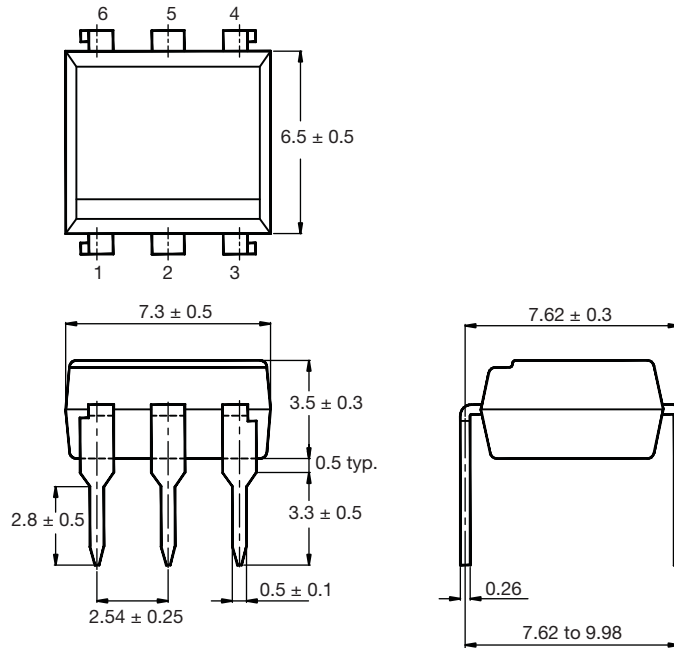

Fig. 15 - Normalized Off-State Voltage M2/M1 vs. Ambient Temperature

**PACKAGE DIMENSIONS** in millimeters



**PACKAGE MARKING**

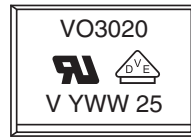

Fig. 16 - Example VO3020-X017T

**Notes**

- VDE logo is only marked on option 1 parts. Option information is not marked on the part
- Tape and reel suffix (T) is not part of the package marking

**PACKING INFORMATION**

| DEVICES PER TUBE |            |           |           |
|------------------|------------|-----------|-----------|
| TYPE             | UNITS/TUBE | TUBES/BOX | UNITS/BOX |
| DIP-6            | 50         | 40        | 2000      |

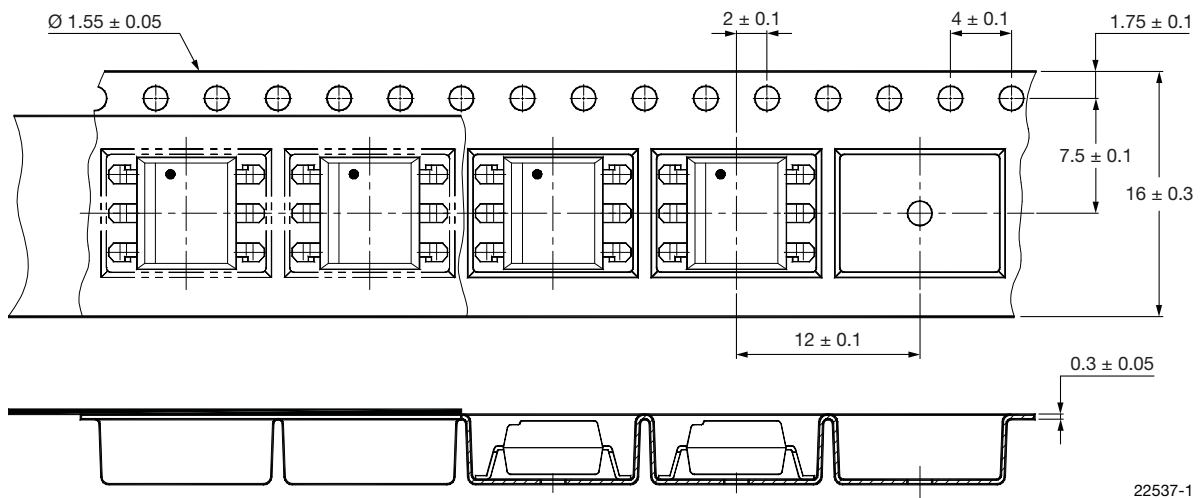

22537-1

Fig. 17 - Tape and Reel Drawing, 1000 Units per Reel

**REEL DIMENSIONS** in millimeters

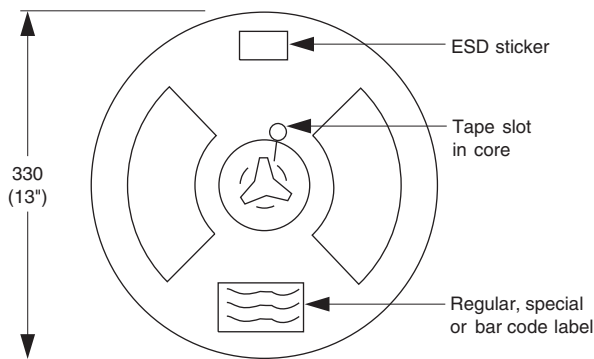

17999

Fig. 18 - Reel Dimensions



## **Disclaimer**

ALL PRODUCT, PRODUCT SPECIFICATIONS AND DATA ARE SUBJECT TO CHANGE WITHOUT NOTICE TO IMPROVE RELIABILITY, FUNCTION OR DESIGN OR OTHERWISE.

Vishay Intertechnology, Inc., its affiliates, agents, and employees, and all persons acting on its or their behalf (collectively, "Vishay"), disclaim any and all liability for any errors, inaccuracies or incompleteness contained in any datasheet or in any other disclosure relating to any product.

Vishay makes no warranty, representation or guarantee regarding the suitability of the products for any particular purpose or the continuing production of any product. To the maximum extent permitted by applicable law, Vishay disclaims (i) any and all liability arising out of the application or use of any product, (ii) any and all liability, including without limitation special, consequential or incidental damages, and (iii) any and all implied warranties, including warranties of fitness for particular purpose, non-infringement and merchantability.

Statements regarding the suitability of products for certain types of applications are based on Vishay's knowledge of typical requirements that are often placed on Vishay products in generic applications. Such statements are not binding statements about the suitability of products for a particular application. It is the customer's responsibility to validate that a particular product with the properties described in the product specification is suitable for use in a particular application. Parameters provided in datasheets and / or specifications may vary in different applications and performance may vary over time. All operating parameters, including typical parameters, must be validated for each customer application by the customer's technical experts. Product specifications do not expand or otherwise modify Vishay's terms and conditions of purchase, including but not limited to the warranty expressed therein.

Except as expressly indicated in writing, Vishay products are not designed for use in medical, life-saving, or life-sustaining applications or for any other application in which the failure of the Vishay product could result in personal injury or death. Customers using or selling Vishay products not expressly indicated for use in such applications do so at their own risk. Please contact authorized Vishay personnel to obtain written terms and conditions regarding products designed for such applications.

No license, express or implied, by estoppel or otherwise, to any intellectual property rights is granted by this document or by any conduct of Vishay. Product names and markings noted herein may be trademarks of their respective owners.



## Данный компонент на территории Российской Федерации

### Вы можете приобрести в компании MosChip.

Для оперативного оформления запроса Вам необходимо перейти по данной ссылке:

<http://moschip.ru/get-element>

Вы можете разместить у нас заказ для любого Вашего проекта, будь то серийное производство или разработка единичного прибора.

В нашем ассортименте представлены ведущие мировые производители активных и пассивных электронных компонентов.

Нашей специализацией является поставка электронной компонентной базы двойного назначения, продукции таких производителей как XILINX, Intel (ex.ALTERA), Vicor, Microchip, Texas Instruments, Analog Devices, Mini-Circuits, Amphenol, Glenair.

Сотрудничество с глобальными дистрибьюторами электронных компонентов, предоставляет возможность заказывать и получать с международных складов практически любой перечень компонентов в оптимальные для Вас сроки.

На всех этапах разработки и производства наши партнеры могут получить квалифицированную поддержку опытных инженеров.

Система менеджмента качества компании отвечает требованиям в соответствии с ГОСТ Р ИСО 9001, ГОСТ РВ 0015-002 и ЭС РД 009

### Офис по работе с юридическими лицами:

105318, г.Москва, ул.Щербаковская д.3, офис 1107, 1118, ДЦ «Щербаковский»

Телефон: +7 495 668-12-70 (многоканальный)

Факс: +7 495 668-12-70 (доб.304)

E-mail: [info@moschip.ru](mailto:info@moschip.ru)

Skype отдела продаж:

moschip.ru

moschip.ru\_4

moschip.ru\_6

moschip.ru\_9