

# Cree® XLamp® ML-E LEDs



## PRODUCT DESCRIPTION

The Cree XLamp ML-E LED brings lighting-class reliability and performance to ½-watt LEDs. The XLamp ML-E expands Cree’s lighting-class leadership to LED bulbs and linear and distributed lighting applications. With XLamp lighting-class reliability, a wide viewing angle, uniform light output, and industry-leading chromaticity binning in a 3.5-mm X 3.5-mm package, the XLamp ML-E LED continues Cree’s history of segment-focused product innovation in LEDs for lighting applications.

The XLamp ML-E LED brings high performance and a smooth look to a wide range of lighting applications, including linear lighting, LED light bulbs, fluorescent retrofits and retail-display lighting.

## FEATURES

- Available in white (2600 K to 8300 K CCT), 80-, 85- and 90-CRI minimum
- Available in royal blue, blue, green, amber and red
- Available in parallel and series Vf configurations for white
- ANSI-compatible sub-bins
- Maximum drive current: 500 mA for parallel white, 167 mA for series white, 350 mA for blue, green and red, 250 mA for amber
- 120° viewing angle for white, 125° viewing angle for color
- Uniform chromaticity profile
- Electrically neutral thermal path
- RoHS- and REACH-compliant
- UL-recognized component (E349212)

## TABLE OF CONTENTS

|   |    |
|---|----|
| Characteristics .....                                 | 2  |
| Flux Characteristics.....                             | 3  |
| Relative Spectral Power Distribution.....             | 6  |
| Relative Luminous Flux vs. Junction Temperature ..... | 7  |
| Relative Radiant Flux vs. Junction Temperature .....  | 8  |
| Electrical Characteristics .....                      | 8  |
| Relative Luminous Flux vs. Current .....              | 10 |
| Relative Radiant Flux vs. Current ..                  | 11 |
| Thermal Design .....                                  | 12 |
| Typical Spatial Distribution.....                     | 15 |
| Reflow Soldering Characteristics ...                  | 17 |
| Notes.....  | 18 |
| Mechanical Dimensions.....                            | 20 |
| Tape and Reel .....                                   | 21 |
| Packaging.....  | 22 |



**CHARACTERISTICS (T<sub>j</sub> = 25 °C)**

| Characteristics  | Unit    | Minimum | Typical | Maximum |
|--|---------|---------|---------|---------|
| Thermal resistance, junction to solder point - white, royal blue, blue | °C/W    |         | 11      |         |
| Thermal resistance, junction to solder point - green, red              | °C/W    |         | 15      |         |
| Thermal resistance, junction to solder point - amber                   | °C/W    |         | 24      |         |
| Viewing angle (FWHM) - white   | degrees |         | 120     |         |
| Viewing angle (FWHM) - royal blue, blue, green, amber, red             | degrees |         | 125     |         |
| Temperature coefficient of voltage - parallel - white                  | mV/°C   |         | -3.3    |         |
| Temperature coefficient of voltage - series - white                    | mV/°C   |         | -10     |         |
| Temperature coefficient of voltage - royal blue, blue                  | mV/°C   |         | -3.3    |         |
| Temperature coefficient of voltage - green                             | mV/°C   |         | -4      |         |
| Temperature coefficient of voltage - red                               | mV/°C   |         | -1.8    |         |
| Temperature coefficient of voltage - amber                             | mV/°C   |         | -1      |         |
| ESD classification (HBM per Mil-Std-883D)                              |         |         | Class 2 |         |
| DC forward current - parallel - white                                  | mA      |         |         | 500     |
| DC forward current - series - white                                    | mA      |         |         | 167     |
| DC forward current - royal blue, blue, green, red                      | mA      |         |         | 350     |
| DC forward current - amber   | mA      |         |         | 250     |
| Reverse voltage  | V       |         |         | -5      |
| Forward voltage (@ 150 mA) - parallel - white                          | V       |         | 3.2     | 3.4     |
| Forward voltage (@ 50 mA) - series - white                             | V       |         | 9.6     | 10.2    |
| Forward voltage (@ 150 mA) - royal blue, blue                          | V       |         | 3.2     |         |
| Forward voltage (@ 150 mA) - green                                     | V       |         | 3.45    |         |
| Forward voltage (@ 150 mA) - red                                       | V       |         | 2.2     |         |
| Forward voltage (@ 150 mA) - amber                                     | V       |         | 2.4     |         |
| LED junction temperature   | °C      |         |         | 150     |

**FLUX CHARACTERISTICS - ML-E PARALLEL WHITE ( $T_j = 25\text{ }^\circ\text{C}$ )**

The following table provides several base order codes for XLamp ML-E LEDs. It is important to note that the base order codes listed here are a subset of the total available order codes for the product family. For more order codes, as well as a complete description of the order-code nomenclature, please consult the XLamp ML-E LED Binning and Labeling document.

| Color             | CCT Range |        | Base Order Codes Minimum Luminous Flux (lm) @ 150 mA |           | Calculated Minimum Luminous Flux (lm)* |        | Order Code            |
|-------------------|-----------|--------|--|-----------|--|--------|-----------------------|
|                   | Min.      | Max.   | Group  | Flux (lm) | 350 mA                                 | 500 mA |                       |
| Cool White        | 5000 K    | 8300 K | N2   | 51.7      | 104.8                                  | 132.9  | MLEAWT-A1-0000-000451 |
|                   |           |        | M3   | 45.7      | 92.6                                   | 117.4  | MLEAWT-A1-0000-000351 |
| 80-CRI Cool White | 6000 K    | 7000 K | M3   | 45.7      | 92.6                                   | 117.4  | MLEAWT-H1-0000-0003E1 |
|                   | 4750 K    | 5250 K | M3   | 45.7      | 92.6                                   | 117.4  | MLEAWT-H1-0000-0003E3 |
| Warm White        | 3700 K    | 4300 K | M3   | 45.7      | 92.6                                   | 117.4  | MLEAWT-A1-0000-0003E5 |
|                   |           |        | M2   | 39.8      | 80.7                                   | 102.3  | MLEAWT-A1-0000-0002E5 |
|                   | 2800 K    | 3200 K | M2   | 39.8      | 80.7                                   | 102.3  | MLEAWT-A1-0000-0002E7 |
|                   |           |        | K3   | 35.2      | 71.4                                   | 90.5   | MLEAWT-A1-0000-0001E7 |
| 80-CRI Warm White | 3700 K    | 4300 K | M2   | 39.8      | 80.7                                   | 102.3  | MLEAWT-H1-0000-0002E5 |
|                   | 2800 K    | 3200 K | K3   | 35.2      | 71.4                                   | 90.5   | MLEAWT-H1-0000-0001E7 |
| 85-CRI Warm White | 2800 K    | 3200 K | K3   | 35.2      | 71.4                                   | 90.5   | MLEAWT-P1-0000-0001E7 |
| 90-CRI Warm White | 2800 K    | 3200 K | K2   | 30.6      | 62                                     | 78.6   | MLEAWT-U1-0000-0000E7 |

**Notes:**

- Cree maintains a tolerance of  $\pm 7\%$  on flux and power measurements,  $\pm 0.005$  on chromaticity (CCx, CCy) measurements and  $\pm 2$  on CRI measurements.
  - Typical CRI for Cool White (4300 K – 8300 K CCT) is 75.
  - Typical CRI for Warm White (2600 K – 4300 K CCT) is 80.
  - Minimum CRI for 80-CRI White is 80.
  - Minimum CRI for 85-CRI White is 85.
  - Minimum CRI for 90-CRI White is 90
- \* Calculated flux values are for reference only.

## FLUX CHARACTERISTICS - ML-E SERIES WHITE ( $T_j = 25\text{ }^\circ\text{C}$ )

The following table provides several base order codes for XLamp ML-E LEDs. It is important to note that the base order codes listed here are a subset of the total available order codes for the product family. For more order codes, as well as a complete description of the order-code nomenclature, please consult the XLamp ML-E LED Binning and Labeling document.

| Color             | CCT Range |        | Base Order Codes Minimum Luminous Flux (lm) @ 50 mA |           | Calculated Minimum Luminous Flux (lm)* |        | Order Code            |
|-------------------|-----------|--------|---|-----------|--|--------|-----------------------|
|                   | Min.      | Max.   | Group   | Flux (lm) | 117 mA                                 | 166 mA |                       |
| Cool White        | 5000 K    | 8300 K | N2  | 51.7      | 104.8                                  | 132.9  | MLESWT-A1-0000-000451 |
|                   |           |        | M3  | 45.7      | 92.6                                   | 117.4  | MLESWT-A1-0000-000351 |
| 80-CRI Cool White | 6000 K    | 7000 K | M3  | 45.7      | 92.6                                   | 117.4  | MLESWT-H1-0000-0003E1 |
|                   | 4750 K    | 5250 K | M3  | 45.7      | 92.6                                   | 117.4  | MLESWT-H1-0000-0003E3 |
| Warm White        | 3700 K    | 4300 K | M3  | 45.7      | 92.6                                   | 117.4  | MLESWT-A1-0000-0003E5 |
|                   |           |        | M2  | 39.8      | 80.7                                   | 102.3  | MLESWT-A1-0000-0002E5 |
|                   | 2800 K    | 3200 K | M2  | 39.8      | 80.7                                   | 102.3  | MLESWT-A1-0000-0002E7 |
|                   |           |        | K3  | 35.2      | 71.4                                   | 90.5   | MLESWT-A1-0000-0001E7 |
| 80-CRI Warm White | 3700 K    | 4300 K | M2  | 39.8      | 80.7                                   | 102.3  | MLESWT-H1-0000-0002E5 |
|                   | 2800 K    | 3200 K | K3  | 35.2      | 71.4                                   | 90.5   | MLESWT-H1-0000-0001E7 |
| 85-CRI Warm White | 2800 K    | 3200 K | K3  | 35.2      | 71.4                                   | 90.5   | MLESWT-P1-0000-0001E7 |
| 90-CRI Warm White | 2800 K    | 3200 K | K2  | 30.6      | 62                                     | 78.6   | MLESWT-U1-0000-0000E7 |

### Notes:

- Cree maintains a tolerance of  $\pm 7\%$  on flux and power measurements,  $\pm 0.005$  on chromaticity (CCx, CCy) measurements and  $\pm 2$  on CRI measurements.
- Typical CRI for Cool White (4300 K – 8300 K CCT) is 75.
- Typical CRI for Warm White (2600 K – 4300 K CCT) is 80.
- Minimum CRI for 80-CRI White is 80.
- Minimum CRI for 85-CRI White is 85.
- Minimum CRI for 90-CRI White is 90.
- \* Calculated flux values are for reference only.

**FLUX CHARACTERISTICS - COLOR ( $T_j = 25\text{ }^\circ\text{C}$ )**

The following table provides several base order codes for XLamp ML-E color LEDs. It is important to note that the base order codes listed here are a subset of the total available order codes for the product family. For more order codes, as well as a complete description of the order-code nomenclature, please consult the XLamp ML Family Binning and Labeling document.

| Color      | Dominant Wavelength Range |          |       |          | Base Order Codes Minimum Radiant Flux (mW) @ 150 mA |           | Order Code            |
|------------|---------------------------|----------|-------|----------|---|-----------|-----------------------|
|            | Min.                      |          | Max.  |          | Group   | Flux (mW) |                       |
|            | Group                     | DWL (nm) | Group | DWL (nm) |   |           |                       |
| Royal Blue | D3                        | 450      | D5    | 465      | 10  | 175       | MLEROY-A1-0000-000501 |

| Color | Dominant Wavelength Range |          |       |          | Base Order Codes Minimum Luminous Flux (lm) @ 150 mA |           | Order Code            |
|-------|---------------------------|----------|-------|----------|--|-----------|-----------------------|
|       | Min.                      |          | Max.  |          | Group  | Flux (lm) |                       |
|       | Group                     | DWL (nm) | Group | DWL (nm) |  |           |                       |
| Blue  | B3                        | 465      | B6    | 485      | G0   | 13.9      | MLEBLU-A1-0000-000U01 |
|       |                           |          |       |          | F0   | 10.7      | MLEBLU-A1-0000-000T01 |

| Color | Dominant Wavelength Range |          |       |          | Base Order Codes Minimum Luminous Flux (lm) @ 150 mA |           | Order Code            |
|-------|---------------------------|----------|-------|----------|--|-----------|-----------------------|
|       | Min.                      |          | Max.  |          | Group  | Flux (lm) |                       |
|       | Group                     | DWL (nm) | Group | DWL (nm) |  |           |                       |
| Green | G2                        | 520      | G4    | 535      | K3   | 35.2      | MLEGRN-A1-0000-000101 |
|       |                           |          |       |          | K2   | 30.6      | MLEGRN-A1-0000-000001 |
|       |                           |          |       |          | J3   | 26.8      | MLEGRN-A1-0000-000X01 |

| Color | Dominant Wavelength Range |          |       |          | Base Order Codes Minimum Luminous Flux (lm) @ 150 mA |           | Order Code            |
|-------|---------------------------|----------|-------|----------|--|-----------|-----------------------|
|       | Min.                      |          | Max.  |          | Group  | Flux (lm) |                       |
|       | Group                     | DWL (nm) | Group | DWL (nm) |  |           |                       |
| Amber | A2                        | 585      | A3    | 595      | K2   | 30.6      | MLEAMB-A1-0000-000001 |
|       |                           |          |       |          | J3   | 26.8      | MLEAMB-A1-0000-000X01 |

| Color | Dominant Wavelength Range |          |       |          | Base Order Codes Minimum Luminous Flux (lm) @ 150 mA |           | Order Code            |
|-------|---------------------------|----------|-------|----------|--|-----------|-----------------------|
|       | Min.                      |          | Max.  |          | Group  | Flux (lm) |                       |
|       | Group                     | DWL (nm) | Group | DWL (nm) |  |           |                       |
| Red   | R2                        | 620      | R3    | 630      | J2   | 23.5      | MLERED-A1-0000-000W01 |
|       |                           |          |       |          | H0   | 18.1      | MLERED-A1-0000-000V01 |

- Note:
- Cree maintains a tolerance of  $\pm 7\%$  on flux and power measurements,  $\pm 0.005$  on chromaticity (CCx, CCy) measurements,  $\pm 2$  on CRI measurements and  $\pm 1$  nm on dominant wavelength measurements.

**RELATIVE SPECTRAL POWER DISTRIBUTION - WHITE**

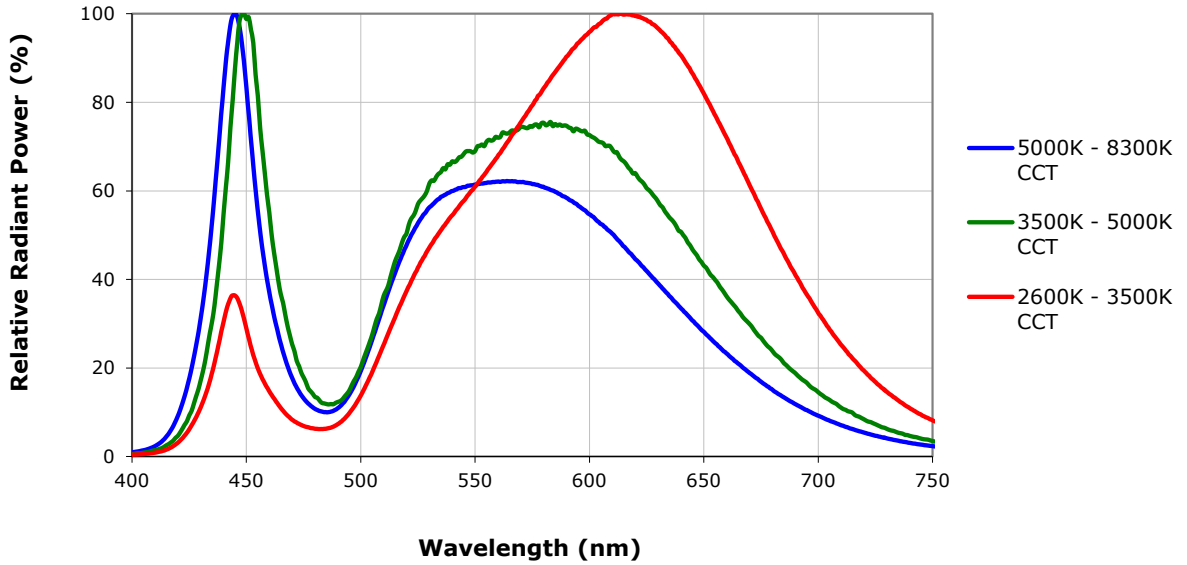

**RELATIVE SPECTRAL POWER DISTRIBUTION - COLOR**

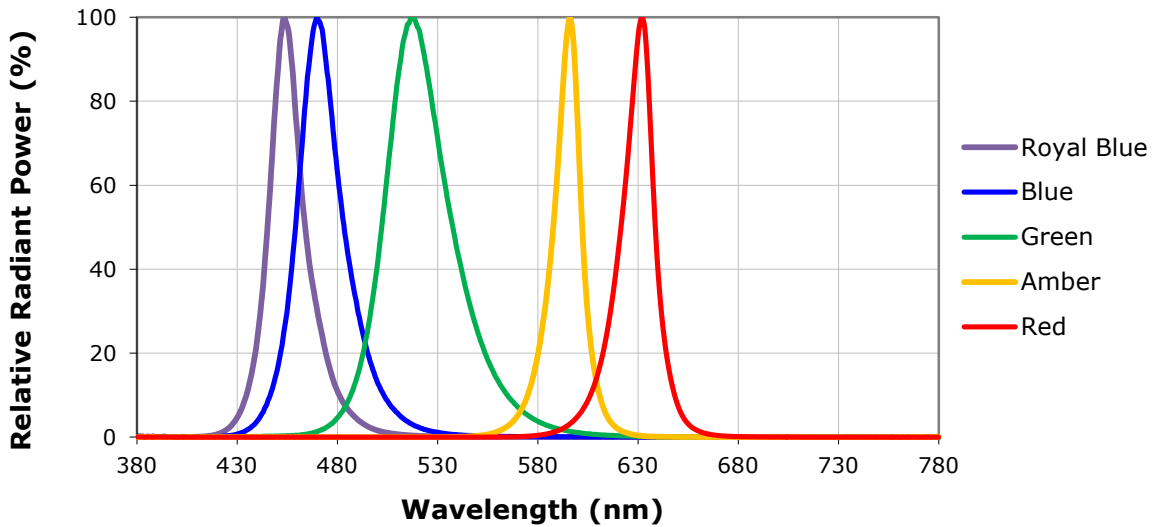

**RELATIVE LUMINOUS FLUX VS. JUNCTION TEMPERATURE - WHITE (ML-E PARALLEL:  
 $I_f = 150\text{ mA}$ , ML-E SERIES:  $I_f = 50\text{ mA}$ )**

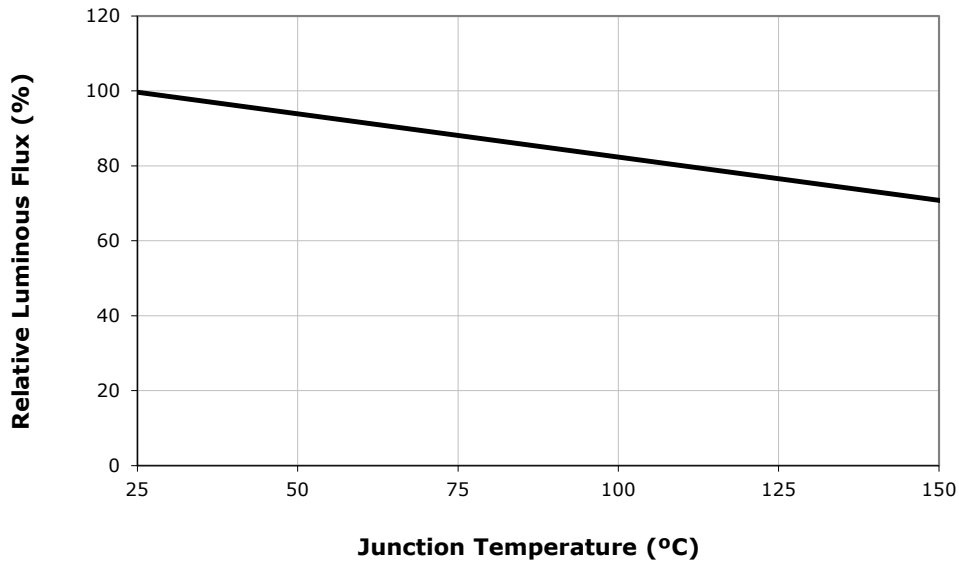

**RELATIVE LUMINOUS FLUX VS. JUNCTION TEMPERATURE - BLUE, GREEN, AMBER, RED  
 $(I_f = 350\text{ mA})$**

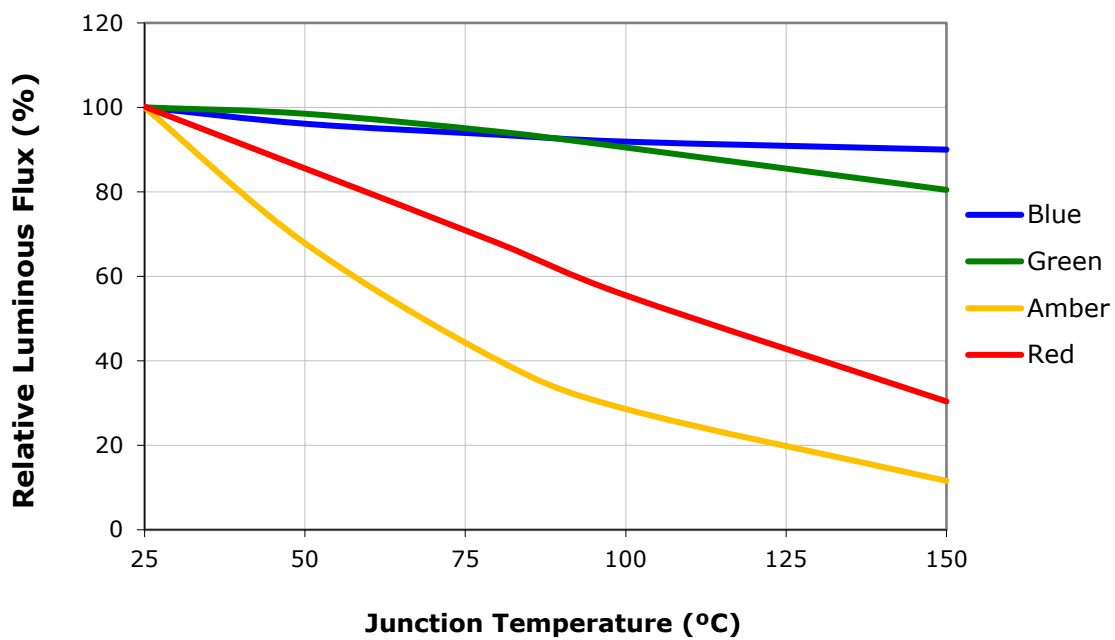

**RELATIVE RADIANT FLUX VS. JUNCTION TEMPERATURE - ROYAL BLUE ( $I_F = 350 \text{ mA}$ )**

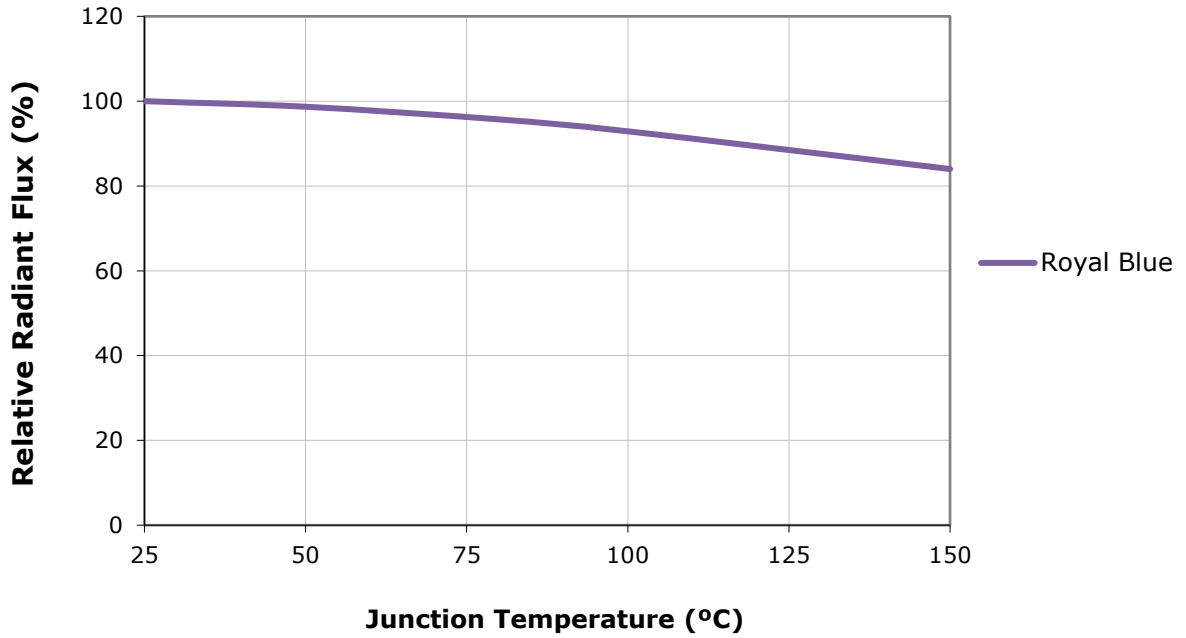

**ELECTRICAL CHARACTERISTICS - ML-E PARALLEL WHITE ( $T_J = 25 \text{ °C}$ )**

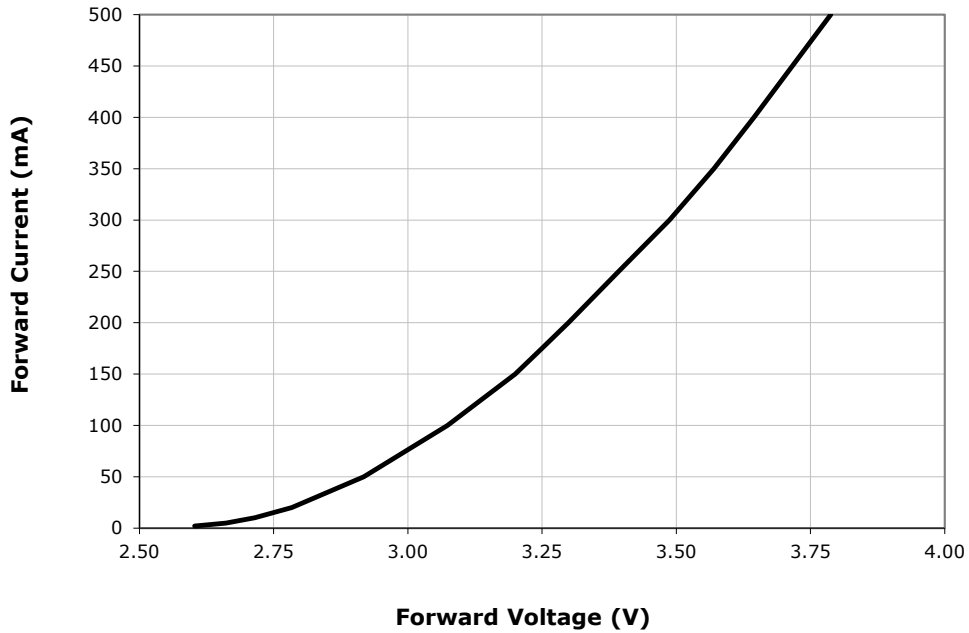



**ELECTRICAL CHARACTERISTICS - ML-E SERIES WHITE ( $T_j = 25\text{ }^\circ\text{C}$ )**

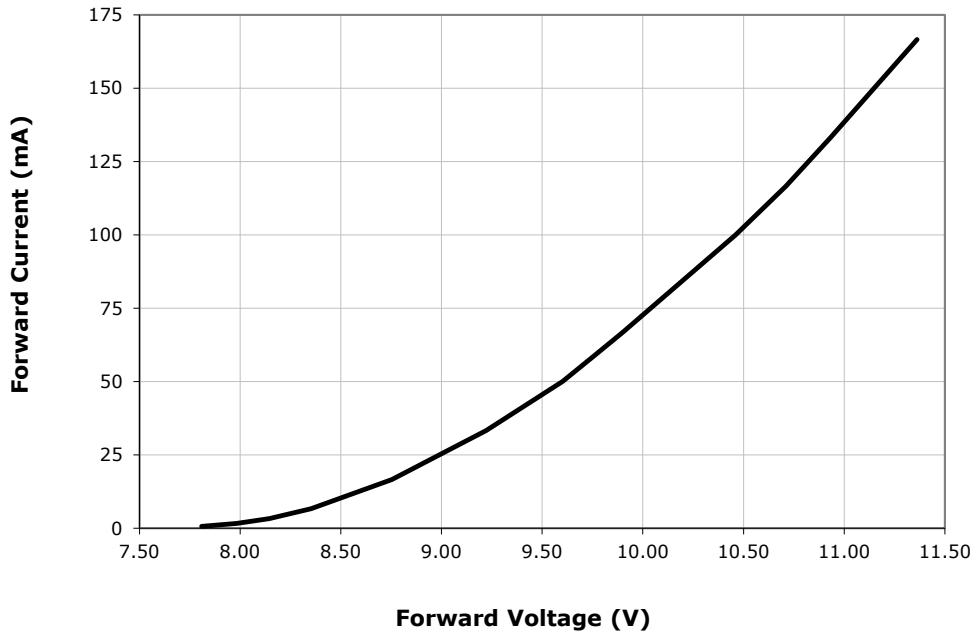

**ELECTRICAL CHARACTERISTICS - COLOR ( $T_j = 25\text{ }^\circ\text{C}$ )**

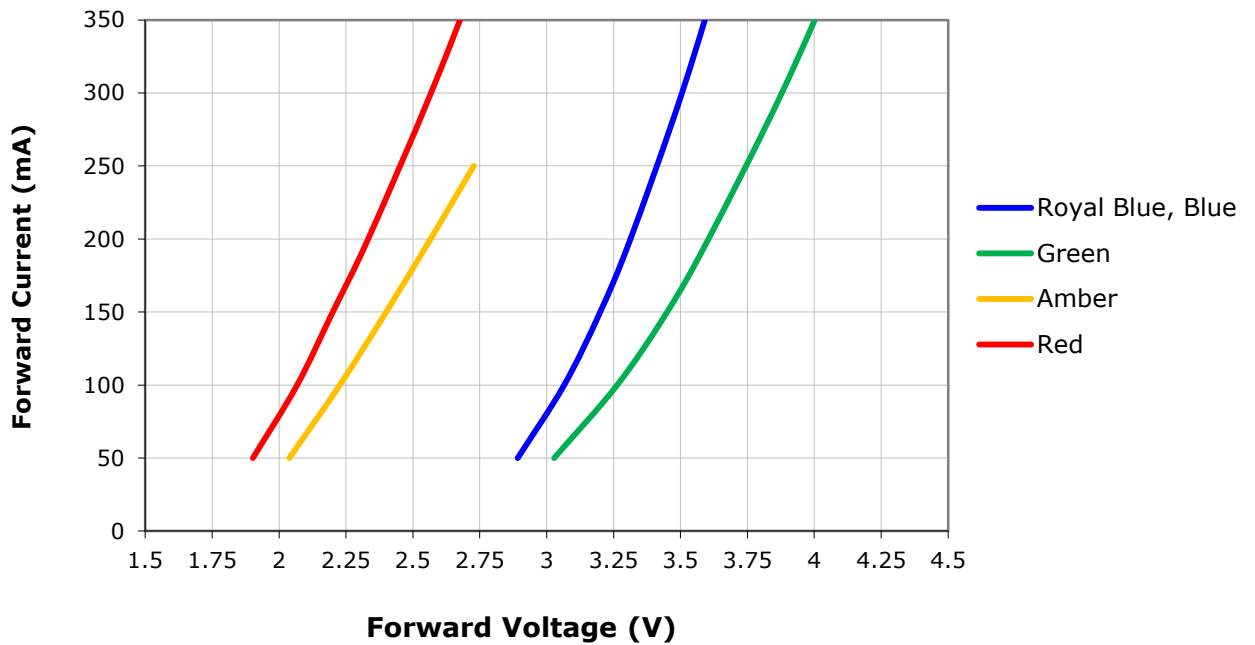

**RELATIVE LUMINOUS FLUX VS. CURRENT - ML-E PARALLEL WHITE ( $T_j = 25\text{ }^\circ\text{C}$ )**

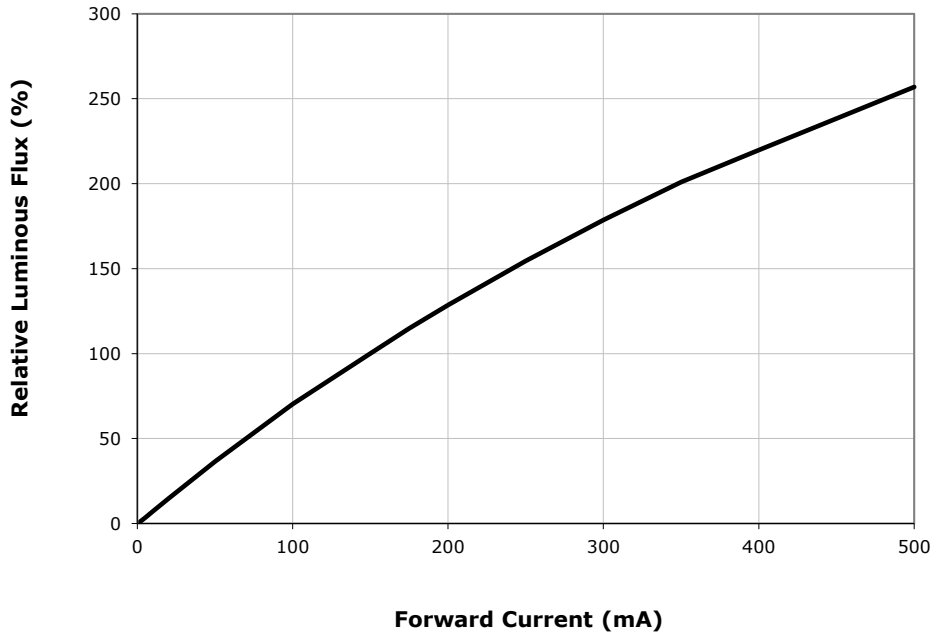

**RELATIVE LUMINOUS FLUX VS. CURRENT - ML-E SERIES WHITE ( $T_j = 25\text{ }^\circ\text{C}$ )**

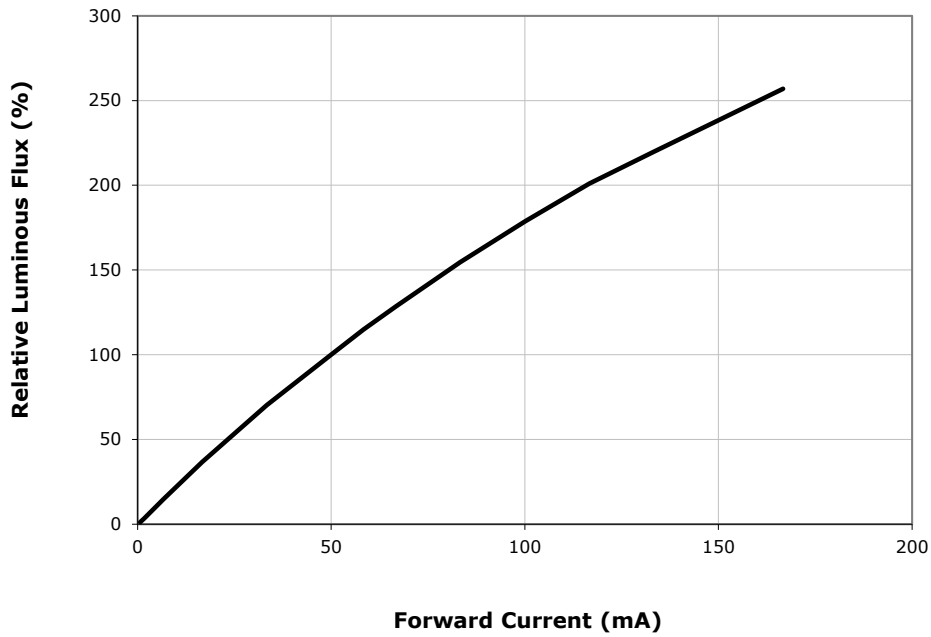

**RELATIVE LUMINOUS FLUX VS. CURRENT - BLUE, GREEN, AMBER, RED ( $T_j = 25\text{ }^\circ\text{C}$ )**

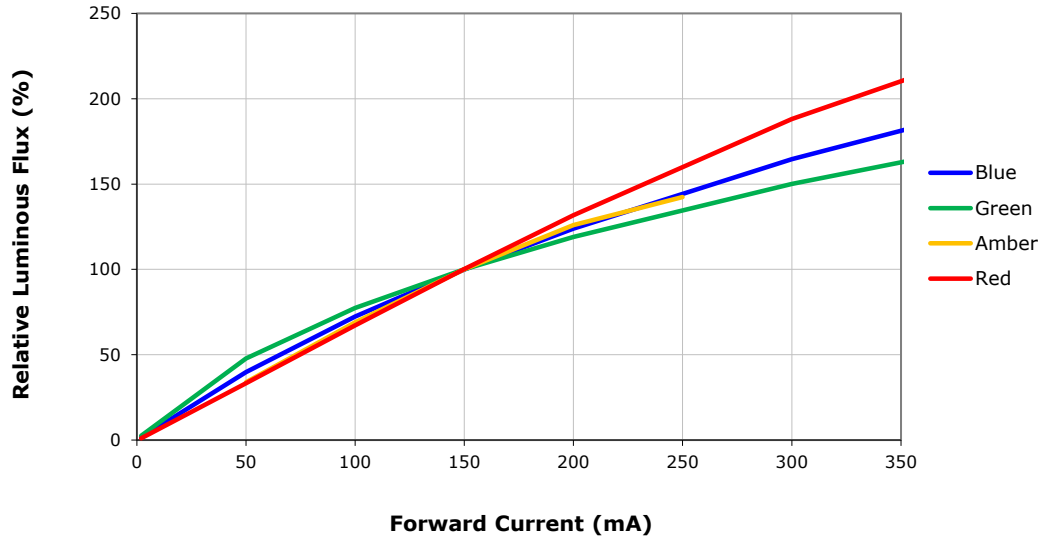

**RELATIVE RADIANT FLUX VS. CURRENT - ROYAL BLUE ( $T_j = 25\text{ }^\circ\text{C}$ )**

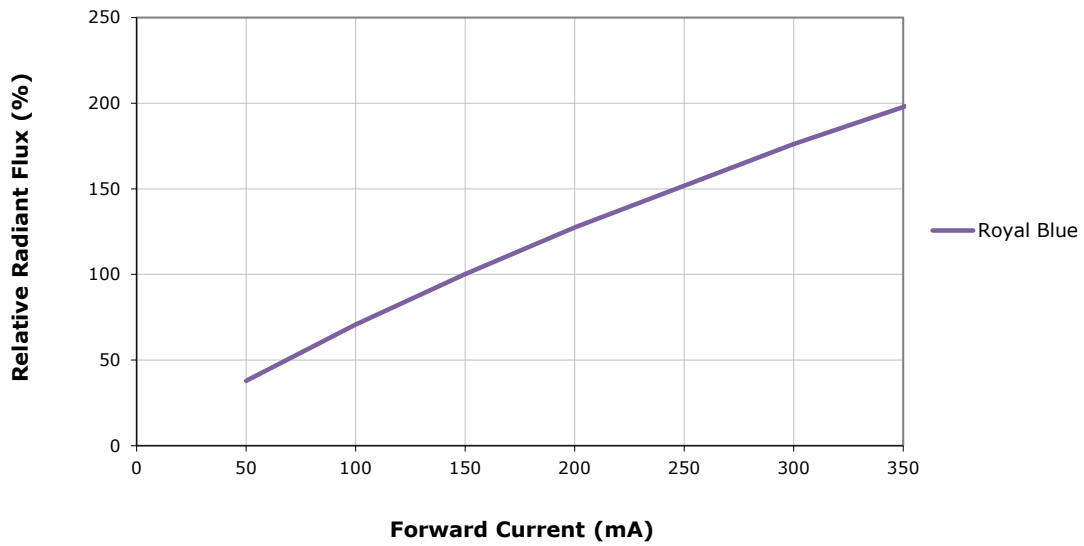

### THERMAL DESIGN - ML-E PARALLEL WHITE

The maximum forward current is determined by the thermal resistance between the LED junction and ambient. It is crucial for the end product to be designed in a manner that minimizes the thermal resistance from the solder point to ambient in order to optimize lamp life and optical characteristics.

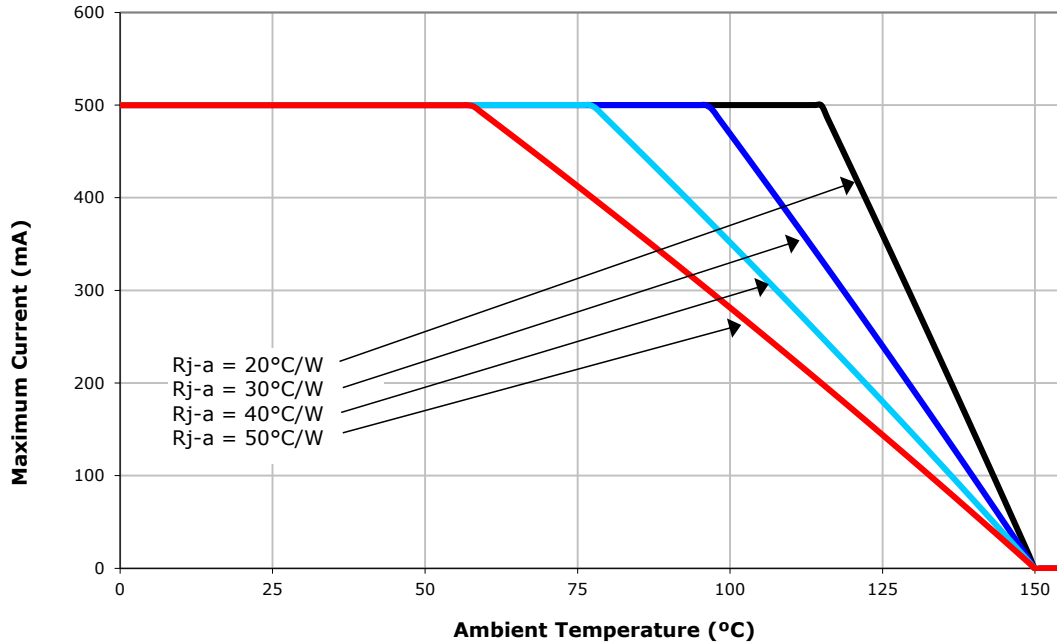

### THERMAL DESIGN - ML-E SERIES WHITE

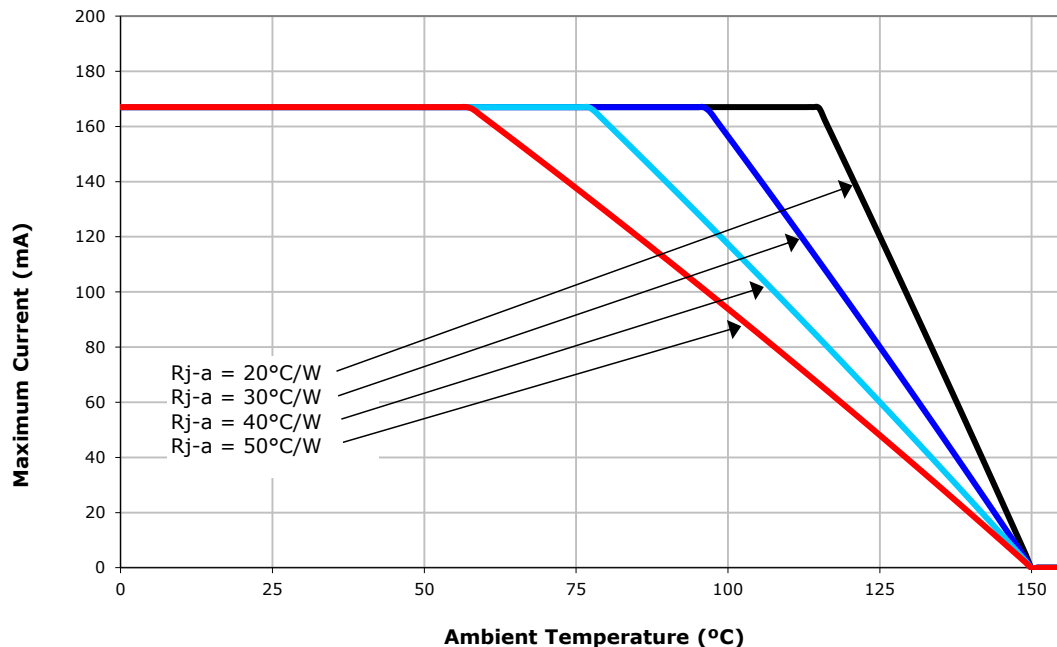

**THERMAL DESIGN - ROYAL BLUE, BLUE**

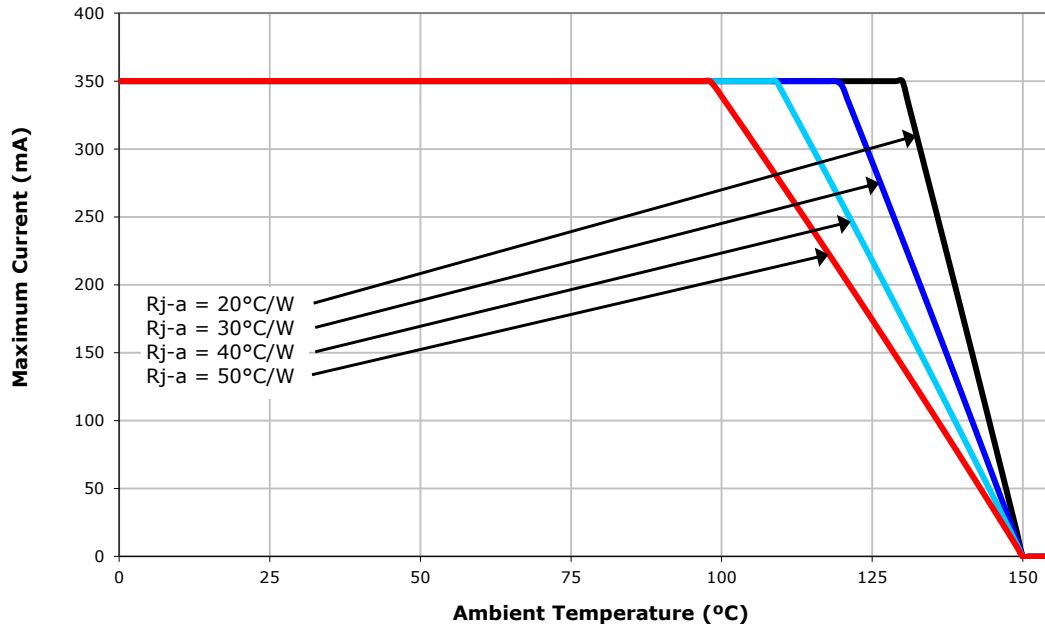

**THERMAL DESIGN - GREEN**

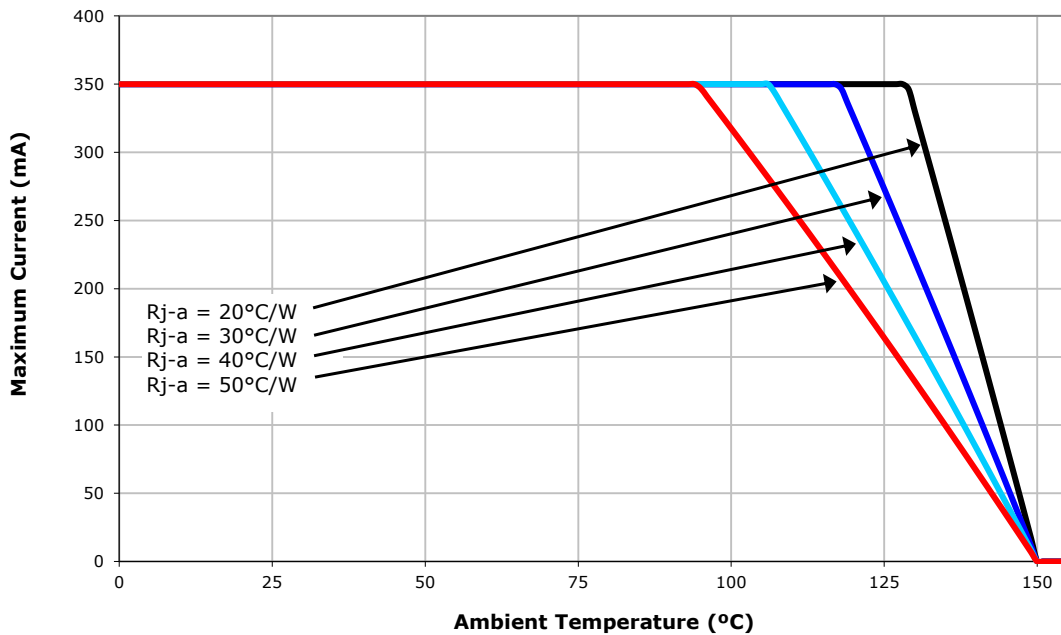

**THERMAL DESIGN - AMBER**

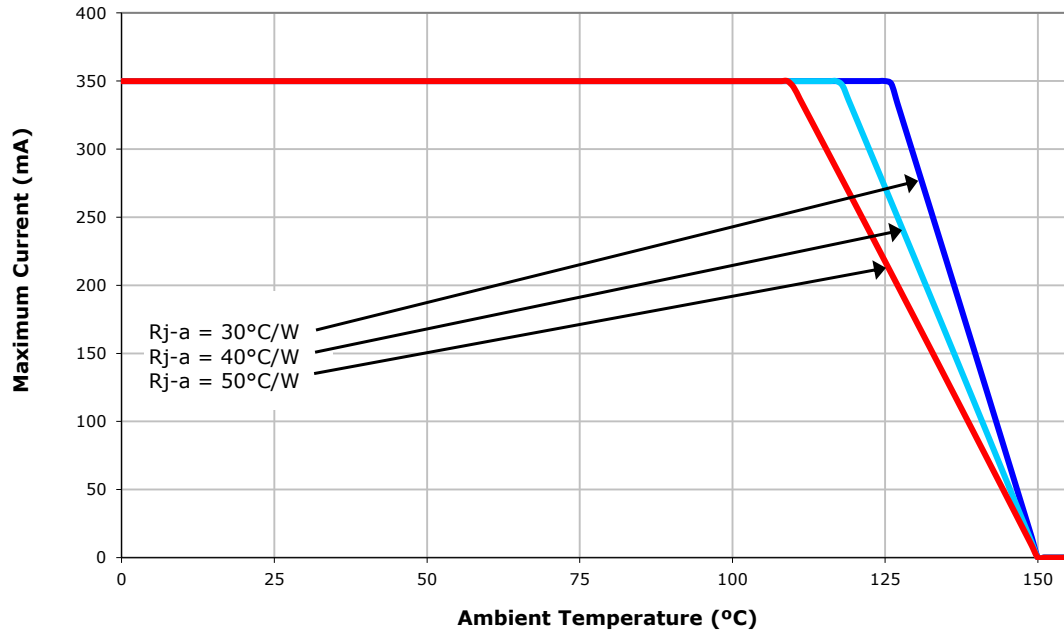

**THERMAL DESIGN - RED**

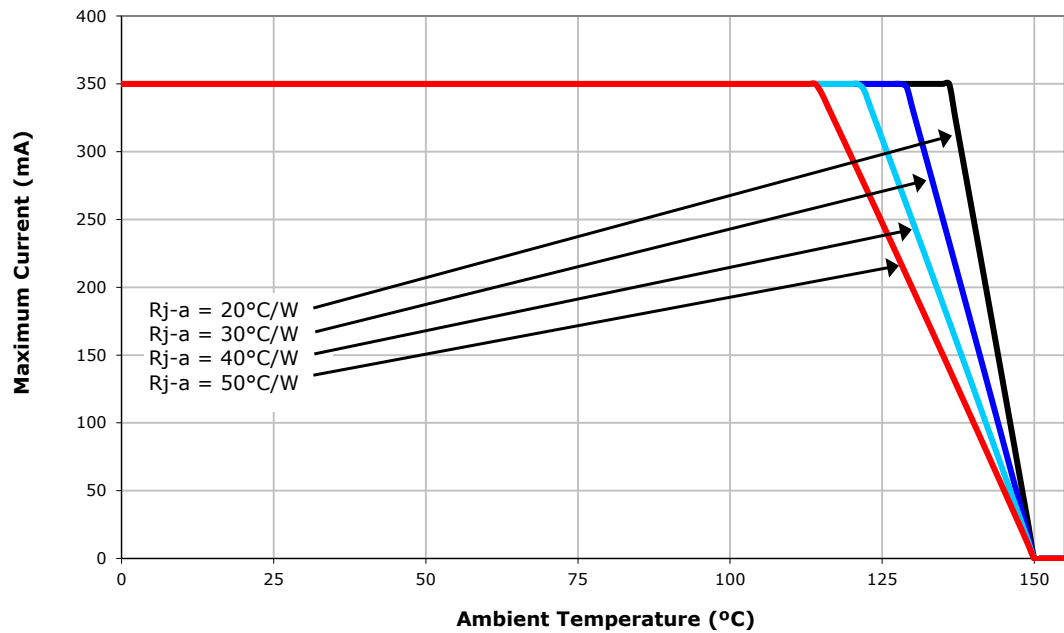

**TYPICAL SPATIAL DISTRIBUTION - WHITE**

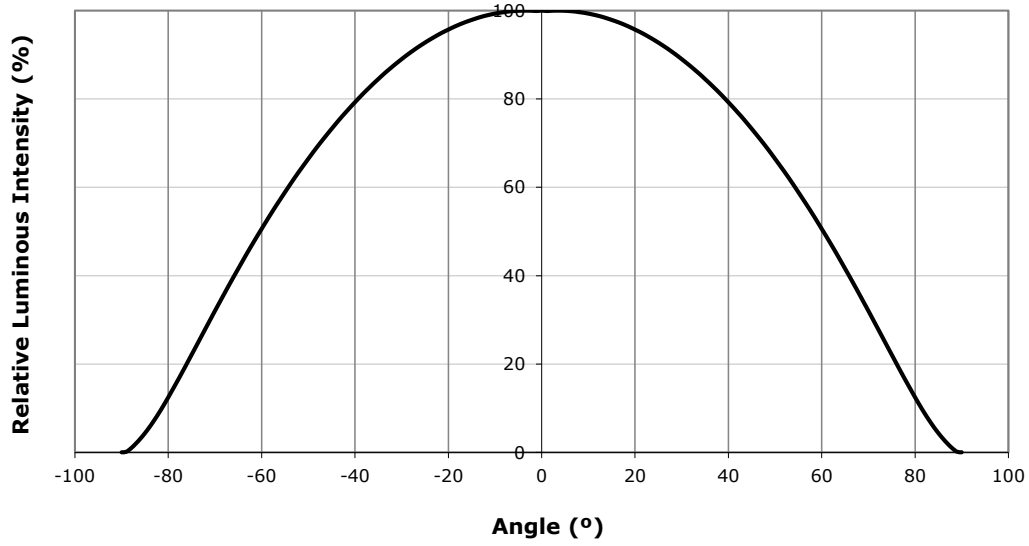

**TYPICAL SPATIAL DISTRIBUTION - ROYAL BLUE, BLUE, GREEN**

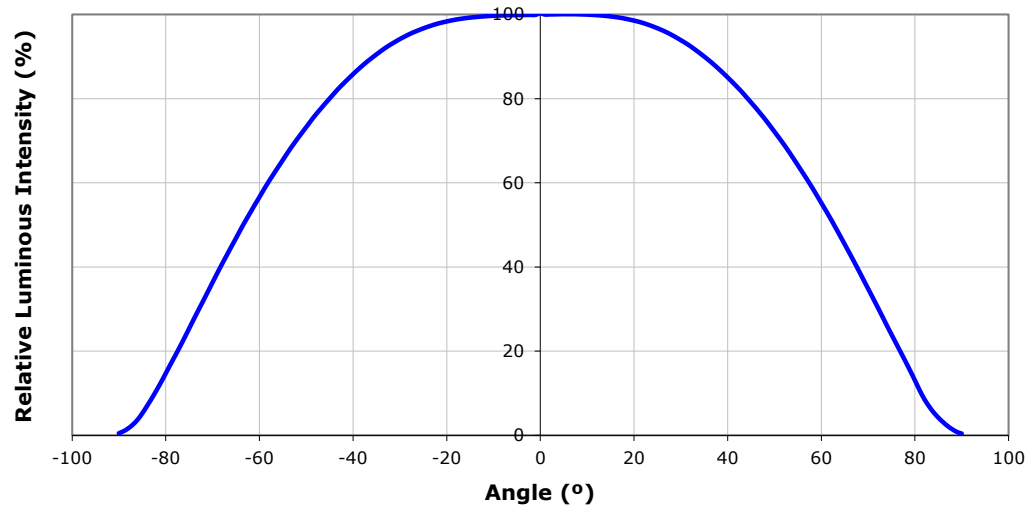

**TYPICAL SPATIAL DISTRIBUTION - AMBER, RED**

---

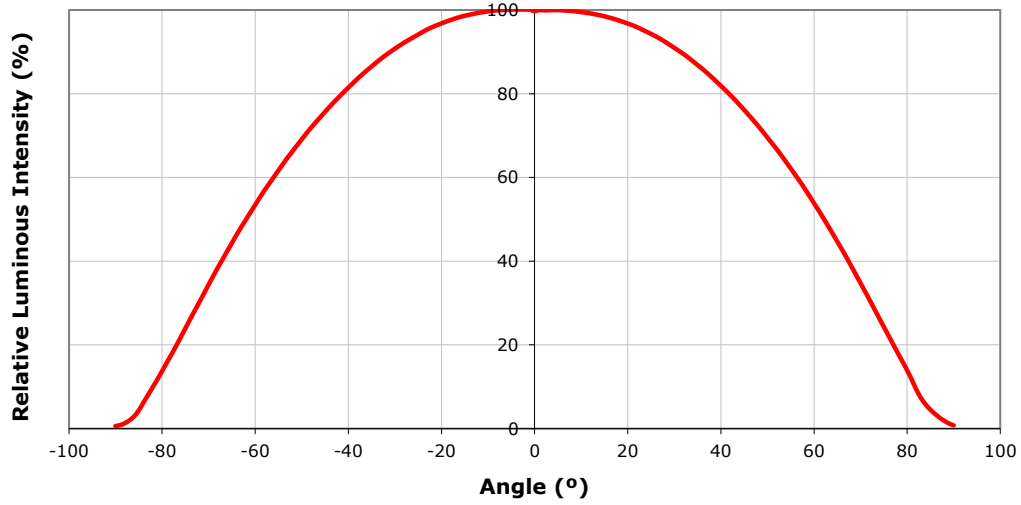



## REFLOW SOLDERING CHARACTERISTICS

In testing, Cree has found XLamp ML-E LEDs to be compatible with JEDEC J-STD-020C, using the parameters listed below. As a general guideline, Cree recommends that users follow the recommended soldering profile provided by the manufacturer of the solder paste used.

Note that this general guideline may not apply to all PCB designs and configurations of reflow soldering equipment.

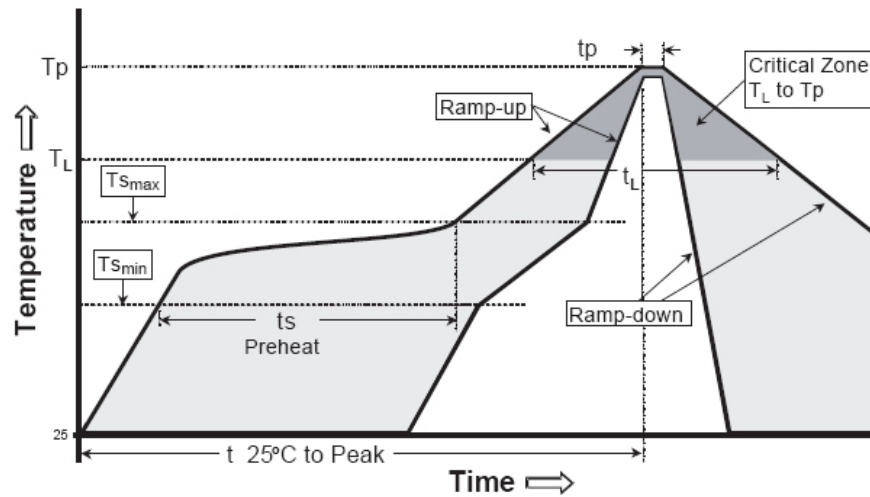

IPC/JEDEC J-STD-020C

| Profile Feature   | Lead-Based Solder | Lead-Free Solder |
|---|-------------------|------------------|
| Average Ramp-Up Rate (Ts <sub>max</sub> to Tp)          | 3 °C/second max.  | 3 °C/second max. |
| Preheat: Temperature Min (Ts <sub>min</sub> )           | 100 °C            | 150 °C           |
| Preheat: Temperature Max (Ts <sub>max</sub> )           | 150 °C            | 200 °C           |
| Preheat: Time (ts <sub>min</sub> to ts <sub>max</sub> ) | 60-120 seconds    | 60-180 seconds   |
| Time Maintained Above: Temperature (T <sub>l</sub> )    | 183 °C            | 217 °C           |
| Time Maintained Above: Time (t <sub>l</sub> )           | 60-150 seconds    | 60-150 seconds   |
| Peak/Classification Temperature (Tp)                    | 215 °C            | 260 °C           |
| Time Within 5 °C of Actual Peak Temperature (tp)        | 10-30 seconds     | 20-40 seconds    |
| Ramp-Down Rate  | 6 °C/second max.  | 6 °C/second max. |
| Time 25 °C to Peak Temperature                          | 6 minutes max.    | 8 minutes max.   |

Note: All temperatures refer to topside of the package, measured on the package body surface.

Note: While the high reflow temperatures (above) have been approved, Cree’s best practice guideline for reflow is to use as low a temperature as possible during the reflow soldering process for these LEDs.

**NOTES**

**Lumen Maintenance Projections**

Cree now uses standardized IES LM-80-08 and TM-21-11 methods for collecting long-term data and extrapolating LED lumen maintenance. For information on the specific LM-80 data sets available for this LED, refer to the public LM-80 results document at [www.cree.com/xlamp\\_app\\_notes/LM80\\_results](http://www.cree.com/xlamp_app_notes/LM80_results).

Please read the XLamp Long-Term Lumen Maintenance application note at [www.cree.com/xlamp\\_app\\_notes/lumen\\_maintenance](http://www.cree.com/xlamp_app_notes/lumen_maintenance) for more details on Cree’s lumen maintenance testing and forecasting. Please read the XLamp Thermal Management application note at [www.cree.com/xlamp\\_app\\_notes/thermal\\_management](http://www.cree.com/xlamp_app_notes/thermal_management) for details on how thermal design, ambient temperature, and drive current affect the LED junction temperature.

**Moisture Sensitivity**

XLamp ML-E LEDs are shipped in sealed, moisture-barrier bags (MBB) designed for long shelf life. If XLamp ML-E LEDs are exposed to moist environments after opening the MBB packaging but before soldering, damage to the LED may occur during the soldering operation. The derating table at right defines the maximum exposure time (in days) for an XLamp ML-E LED in the listed humidity and temperature conditions.

| Temp. | Maximum Percent Relative Humidity |     |     |     |     |     |     |
|-------|-----------------------------------|-----|-----|-----|-----|-----|-----|
|       | 30%                               | 40% | 50% | 60% | 70% | 80% | 90% |
| 35 °C | -                                 | -   | -   | 17  | 1   | .5  | .5  |
| 30 °C | -                                 | -   | -   | 28  | 1   | 1   | 1   |
| 25 °C | -                                 | -   | -   | -   | 2   | 1   | 1   |
| 20 °C | -                                 | -   | -   | -   | 2   | 1   | 1   |

LEDs with exposure time longer than the time specified below must be baked according to the baking conditions listed below.

Cree recommends keeping XLamp LEDs in their sealed moisture-barrier packaging until immediately prior to use. Cree also recommends returning any unused LEDs to the resealable moisture-barrier bag and closing the bag immediately after use.

**Baking Conditions**

It is not necessary to bake all XLamp ML-E LEDs. Only the LEDs that meet all of the following criteria must be baked:

1. LEDs that have been removed from the original MBB packaging.
2. LEDs that have been exposed to a humid environment longer than listed in the Moisture Sensitivity section above.
3. LEDs that have not been soldered.

LEDs should be baked at 70 °C for 24 hours. LEDs may be baked on the original reels. Remove LEDs from MBB packaging before baking. Do not bake parts at temperatures higher than 70 °C. This baking operation resets the exposure time as defined in the Moisture Sensitivity section above.

## Storage Conditions

XLamp ML-E LEDs that have been removed from the original MBB packaging but not soldered should be stored in one of the following ways:

- Store the parts in a rigid metal container with a tight-fitting lid. Verify that the storage temperature is  $<30^{\circ}\text{C}$ , and place fresh desiccant and an RH indicator in the container to verify that the RH is no greater than 60%.
- Store the parts in a dry, nitrogen-purged cabinet or container that actively maintains the temperature at  $<30^{\circ}$  and the RH at no greater than 60%.
- For short-term store only: LEDs can be resealed in the original MBB bag soon after opening. Fresh desiccant may be needed. Use the included humidity indicator card to verify  $<60\%$  RH.

If an environment of  $<60\%$  RH is not available for storage, XLamp ML-E LEDs should be baked (described above) before reflow soldering.

## RoHS Compliance

The levels of RoHS restricted materials in this product are below the maximum concentration values (also referred to as the threshold limits) permitted for such substances, or are used in an exempted application, in accordance with EU Directive 2011/65/EC (RoHS2), as amended through June 8, 2011. RoHS Declarations for this product can be obtained from your Cree representative or obtained from the Product Ecology section of [www.cree.com](http://www.cree.com).

## REACH Compliance

REACH substances of high concern (SVHCs) information is available for this product. Since the European Chemical Agency (ECHA) has published notices of their intent to frequently revise the SVHC listing for the foreseeable future, please contact a Cree representative to insure you get the most up-to-date REACH Declaration. Historical REACH banned substance information (substances restricted or banned in the EU prior to 2010) is also available upon request.

## UL Recognized Component

Level 4 enclosure consideration. The LED package or a portion thereof has been investigated as a fire and electrical enclosure per ANSI/UL 8750.

## Vision Advisory Claim

**WARNING:** Do not look at an exposed lamp in operation. Eye injury can result. See LED Eye Safety at [www.cree.com/xlamp\\_app\\_notes/led\\_eye\\_safety](http://www.cree.com/xlamp_app_notes/led_eye_safety).

**MECHANICAL DIMENSIONS (T<sub>A</sub> = 25 °C)**

All measurements are ±.13 mm unless otherwise indicated.

Top View

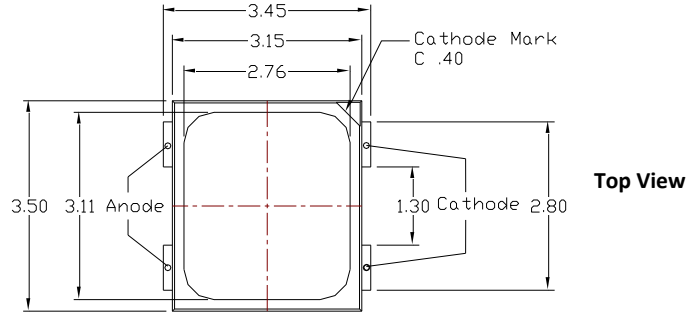
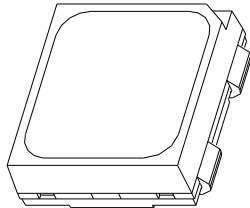

Bottom View

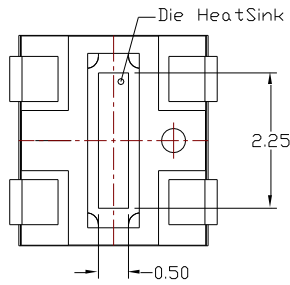

Side View

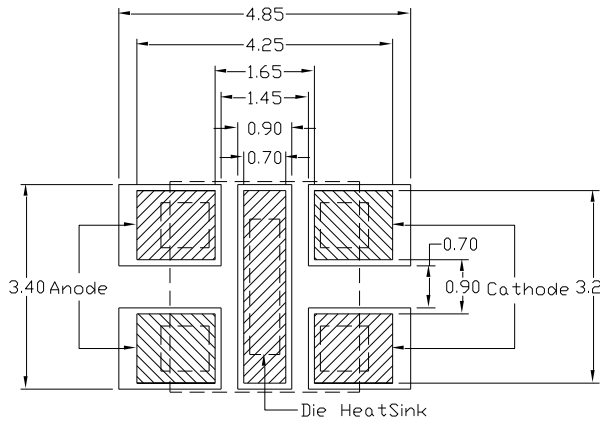
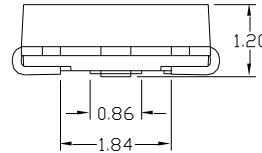

**Recommended PCB Solder Pad**

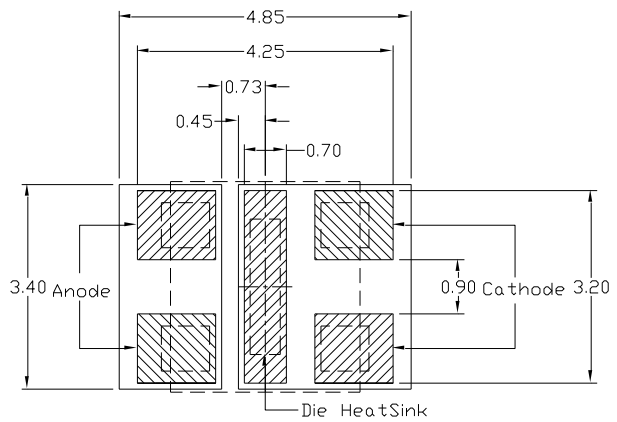

**Alternative Solder Pad**

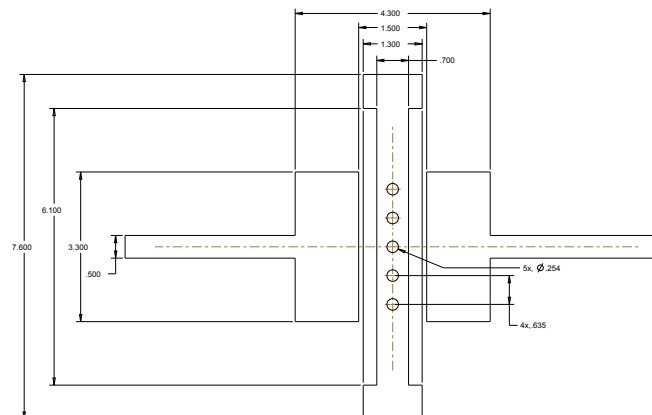

**Recommended FR4 Solder Pad w/Thermal Vias**

**TAPE AND REEL**

All Cree carrier tapes conform to EIA-481D, Automated Component Handling Systems Standard.

All dimensions in mm.

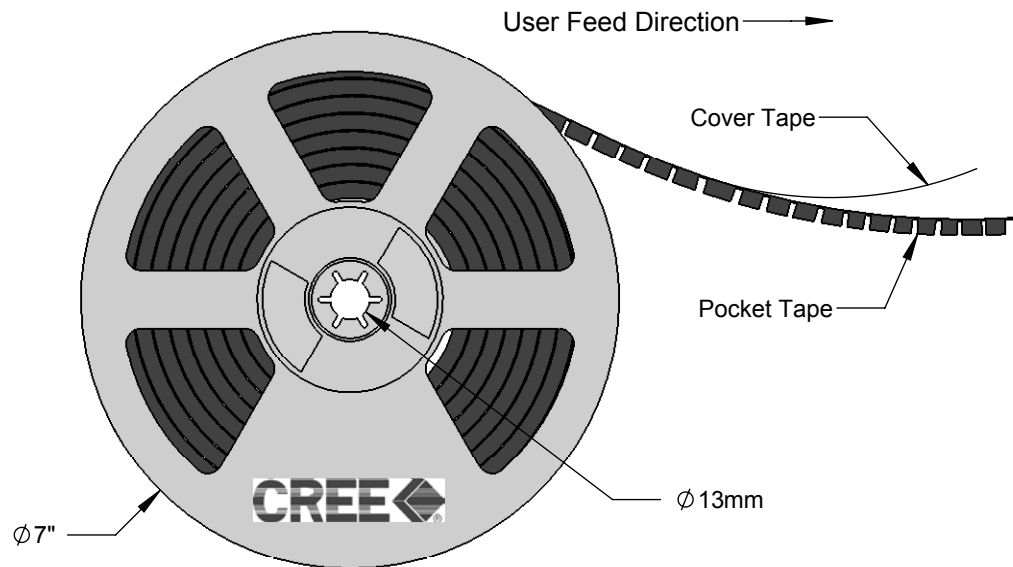
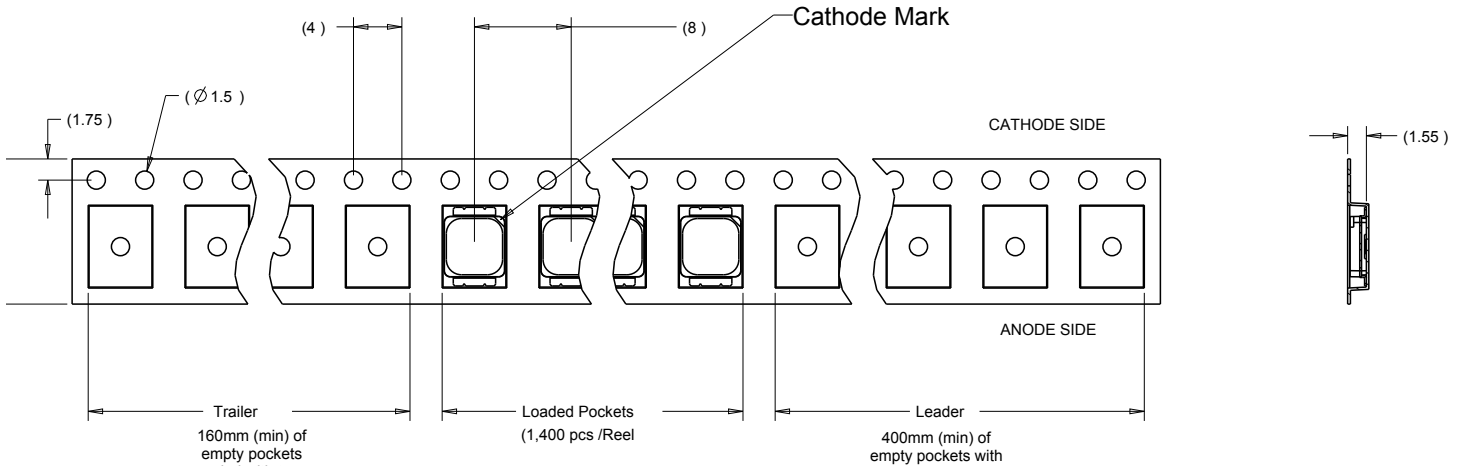

**PACKAGING**

**Unpackaged Reel**

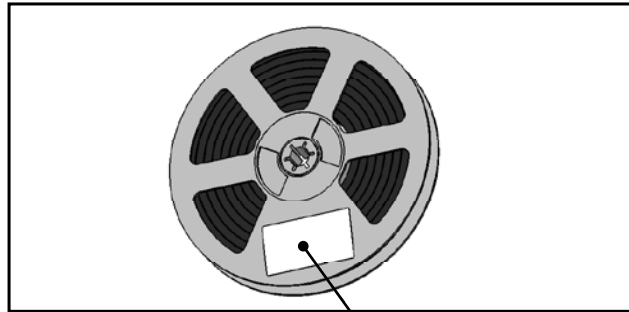

Label with Cree Bin Code, Qty, Reel ID

**Packaged Reel**

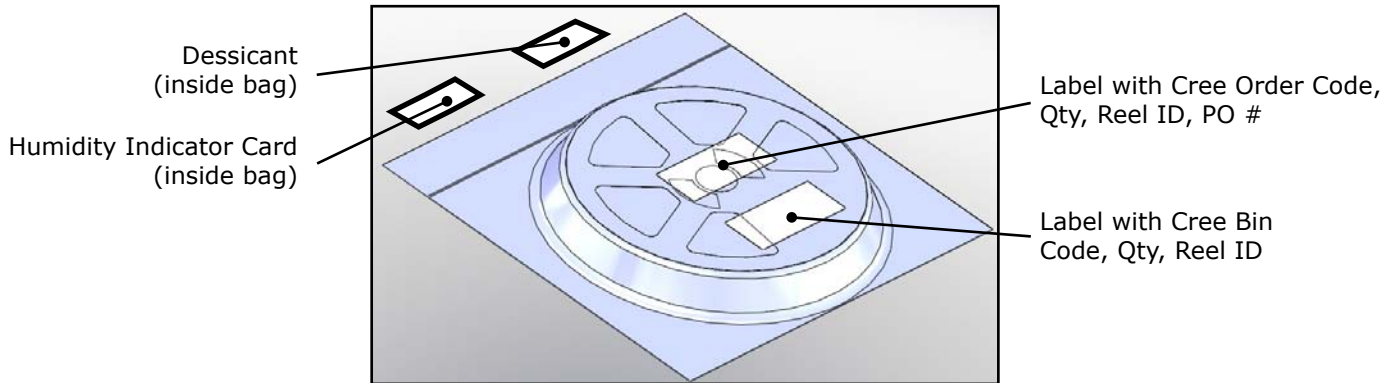

**Boxed Reel**

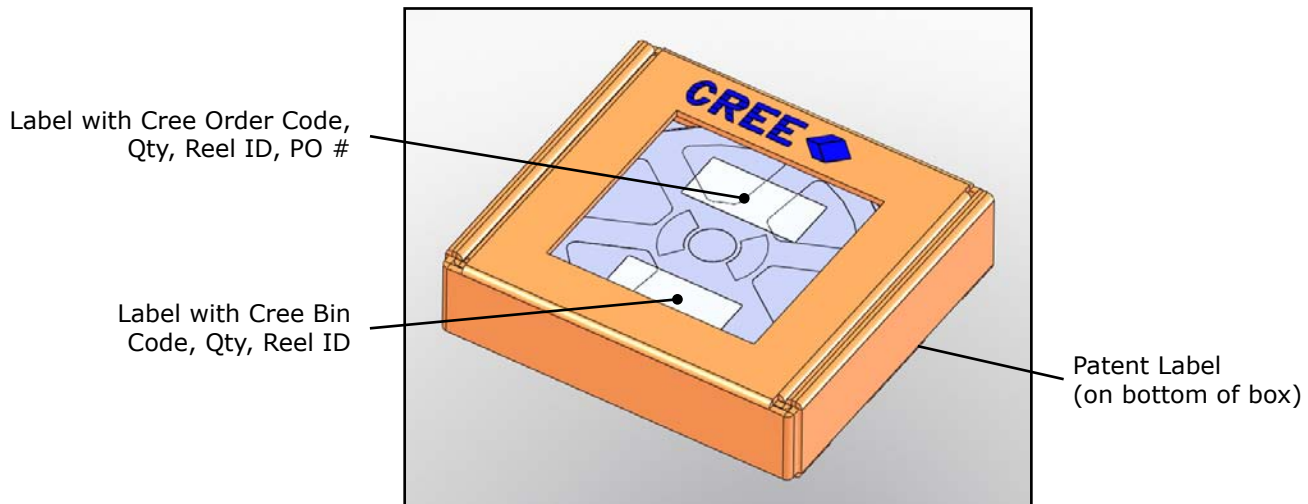

## Данный компонент на территории Российской Федерации

### Вы можете приобрести в компании MosChip.

Для оперативного оформления запроса Вам необходимо перейти по данной ссылке:

<http://moschip.ru/get-element>

Вы можете разместить у нас заказ для любого Вашего проекта, будь то серийное производство или разработка единичного прибора.

В нашем ассортименте представлены ведущие мировые производители активных и пассивных электронных компонентов.

Нашей специализацией является поставка электронной компонентной базы двойного назначения, продукции таких производителей как XILINX, Intel (ex.ALTERA), Vicor, Microchip, Texas Instruments, Analog Devices, Mini-Circuits, Amphenol, Glenair.

Сотрудничество с глобальными дистрибьюторами электронных компонентов, предоставляет возможность заказывать и получать с международных складов практически любой перечень компонентов в оптимальные для Вас сроки.

На всех этапах разработки и производства наши партнеры могут получить квалифицированную поддержку опытных инженеров.

Система менеджмента качества компании отвечает требованиям в соответствии с ГОСТ Р ИСО 9001, ГОСТ РВ 0015-002 и ЭС РД 009

### Офис по работе с юридическими лицами:

105318, г.Москва, ул.Щербаковская д.3, офис 1107, 1118, ДЦ «Щербаковский»

Телефон: +7 495 668-12-70 (многоканальный)

Факс: +7 495 668-12-70 (доб.304)

E-mail: [info@moschip.ru](mailto:info@moschip.ru)

Skype отдела продаж:

moschip.ru

moschip.ru\_4

moschip.ru\_6

moschip.ru\_9