

## Hyperfast Rectifier, 15 A FRED Pt®

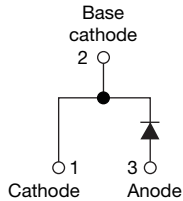

2L TO-220AC



VS-ETH1506-M3



2L TO-220 FULL-PAK

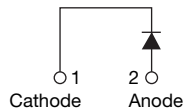

VS-ETH1506FP-M3

### FEATURES

- Hyperfast soft recovery time
- Low forward voltage drop
- 175 °C operating junction temperature
- Low leakage current
- Fully isolated package ( $V_{INS} = 2500 V_{RMS}$ )
- True 2 pin package
- Compliant to RoHS Directive 2002/95/EC
- Halogen-free according to IEC 61249-2-21 definition
- Designed and qualified according to JEDEC-JESD47



**RoHS**  
COMPLIANT  
HALOGEN  
**FREE**

### DESCRIPTION/APPLICATIONS

Hyperfast recovery rectifiers designed with optimized performance of forward voltage drop, hyperfast recovery time, and soft recovery.

The planar structure and the platinum doped life time control guarantee the best overall performance, ruggedness and reliability characteristics.

These devices are intended for use in PFC boost stage in the AC/DC section of SMPS, inverters or as freewheeling diodes.

The extremely optimized stored charge and low recovery current minimize the switching losses and reduce over dissipation in the switching element and snubbers.

### PRODUCT SUMMARY

Package	2L TO-220AC, 2L TO-220FP
$I_{F(AV)}$	15 A
$V_R$	600 V
$V_F$ at $I_F$	2.45 V
$t_{rr}$ (typ.)	21 ns
$T_J$ max.	175 °C
Diode variation	Single die

### ABSOLUTE MAXIMUM RATINGS

PARAMETER	SYMBOL	TEST CONDITIONS	VALUES	UNITS
Peak repetitive reverse voltage	$V_{RRM}$		600	V
Average rectified forward current in DC	$I_{F(AV)}$	$T_C = 149\text{ °C}$	15	A
		$T_C = 94\text{ °C}$		
Non-repetitive peak surge current	$I_{FSM}$	$T_J = 25\text{ °C}$	160	
Operating junction and storage temperatures	$T_J, T_{Stg}$		- 65 to 175	°C

### ELECTRICAL SPECIFICATIONS ( $T_J = 25\text{ °C}$ unless otherwise specified)

PARAMETER	SYMBOL	TEST CONDITIONS	MIN.	TYP.	MAX.	UNITS
Breakdown voltage, blocking voltage	$V_{BR}, V_R$	$I_R = 100\text{ }\mu\text{A}$	600	-	-	V
Forward voltage	$V_F$	$I_F = 15\text{ A}$	-	1.8	2.45	
		$I_F = 15\text{ A}, T_J = 150\text{ °C}$	-	1.25	1.6	
Reverse leakage current	$I_R$	$V_R = V_R$ rated	-	0.01	15	$\mu\text{A}$
		$T_J = 150\text{ °C}, V_R = V_R$ rated	-	20	200	
Junction capacitance	$C_T$	$V_R = 600\text{ V}$	-	12	-	pF
Series inductance	$L_S$	Measured lead to lead 5 mm from package body	-	8	-	nH

# VS-ETH1506-M3, VS-ETH1506FP-M3



Vishay Semiconductors Hyperfast Rectifier, 15 A FRED Pt®

DYNAMIC RECOVERY CHARACTERISTICS ( $T_J = 25\text{ }^\circ\text{C}$ unless otherwise specified)							
PARAMETER	SYMBOL	TEST CONDITIONS	MIN.	TYP.	MAX.	UNITS	
Reverse recovery time	$t_{rr}$	$I_F = 1\text{ A}$ , $di_F/dt = 100\text{ A}/\mu\text{s}$ , $V_R = 30\text{ V}$	-	21	26	ns	
		$I_F = 15\text{ A}$ , $di_F/dt = 100\text{ A}/\mu\text{s}$ , $V_R = 30\text{ V}$	-	25	36		
		$T_J = 25\text{ }^\circ\text{C}$	-	29	-		
		$T_J = 125\text{ }^\circ\text{C}$	-	65	-		
Peak recovery current	$I_{RRM}$	$T_J = 25\text{ }^\circ\text{C}$	-	3.9	-	A	
		$T_J = 125\text{ }^\circ\text{C}$	-	7.0	-		
Reverse recovery charge	$Q_{rr}$	$T_J = 25\text{ }^\circ\text{C}$	-	60	-	nC	
		$T_J = 125\text{ }^\circ\text{C}$	-	240	-		
Reverse recovery time	$t_{rr}$	$T_J = 125\text{ }^\circ\text{C}$	$I_F = 15\text{ A}$ $di_F/dt = 800\text{ A}/\mu\text{s}$ $V_R = 390\text{ V}$	-	42	-	ns
Peak recovery current	$I_{RRM}$			-	21	-	A
Reverse recovery charge	$Q_{rr}$			-	480	-	nC

THERMAL - MECHANICAL SPECIFICATIONS						
PARAMETER	SYMBOL	TEST CONDITIONS	MIN.	TYP.	MAX.	UNITS
Maximum junction and storage temperature range	$T_J, T_{Stg}$		- 65	-	175	$^\circ\text{C}$
Thermal resistance, junction to case FULL-PAK	$R_{thJC}$		-	1.2	1.4	$^\circ\text{C}/\text{W}$
			-	3.7	4.3	
Thermal resistance, junction to ambient	$R_{thJA}$	Typical socket mount	-	-	70	
Typical thermal resistance, case to heatsink	$R_{thCS}$	Mounting surface, flat, smooth and greased	-	0.5	-	
Weight			-	2	-	g
			-	0.07	-	oz.
Mounting torque			6 (5)	-	12 (10)	kgf · cm (lbf · in)
Marking device		Case style 2L TO-220AC	ETH1506			
		Case style 2L TO-220 FULL-PAK	ETH1506FP			



# VS-ETH1506-M3, VS-ETH1506FP-M3

Hyperfast Rectifier, 15 A FRED Pt<sup>®</sup> Vishay Semiconductors

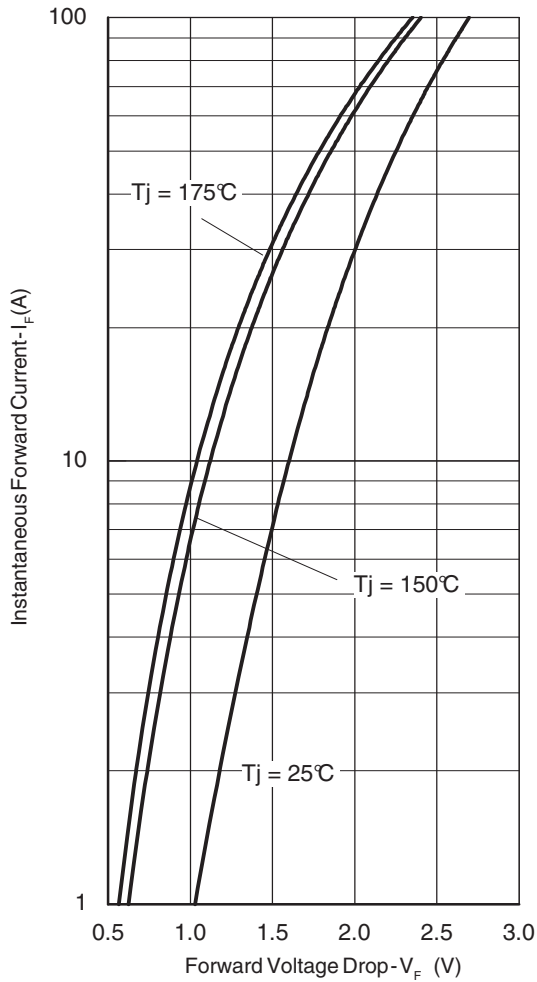

Fig. 1 - Typical Forward Voltage Drop Characteristics

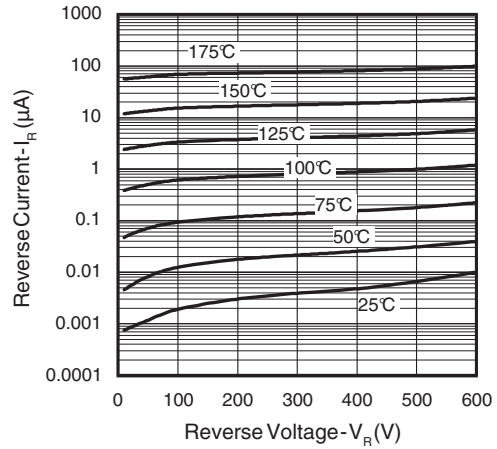

Fig. 2 - Typical Values of Reverse Current vs. Reverse Voltage

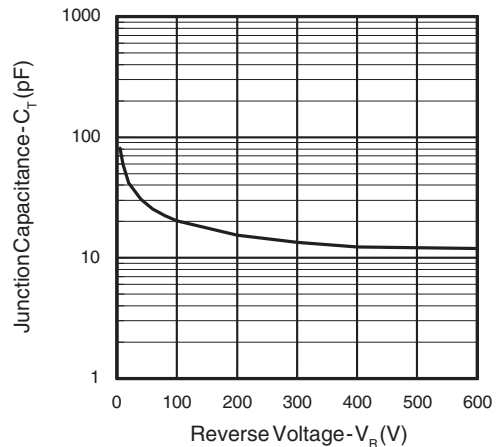

Fig. 3 - Typical Junction Capacitance vs. Reverse Voltage

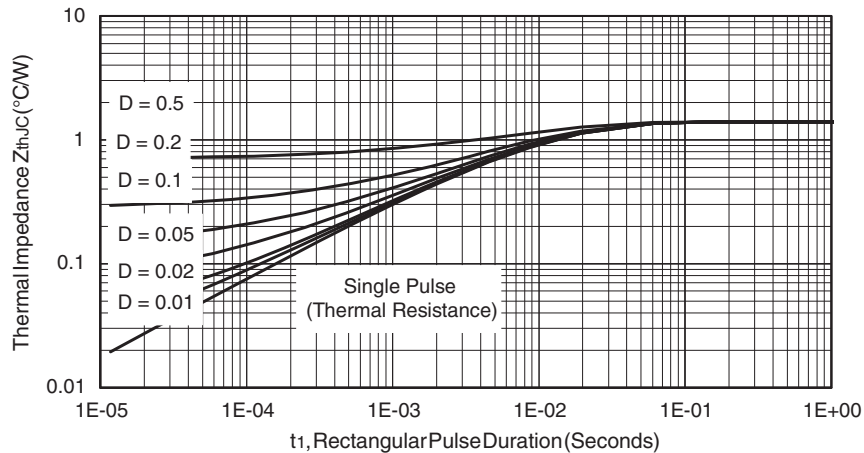

Fig. 4 - Maximum Thermal Impedance  $Z_{thJC}$  Characteristics

# VS-ETH1506-M3, VS-ETH1506FP-M3

Vishay Semiconductors Hyperfast Rectifier, 15 A FRED Pt®

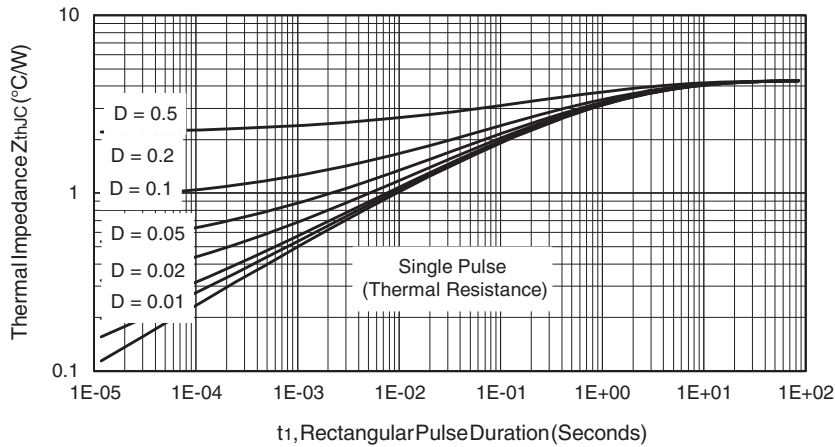

Fig. 5 - Maximum Thermal Impedance  $Z_{thJC}$  Characteristics (FULL-PAK)

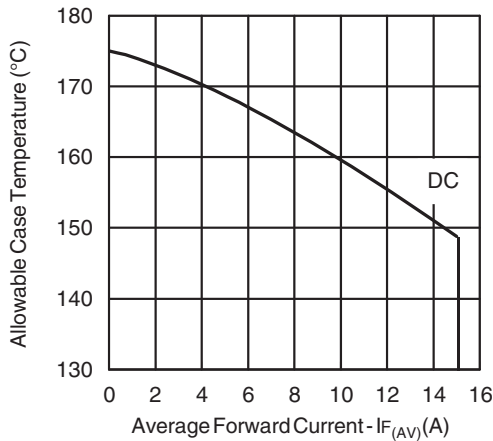

Fig. 6 - Maximum Allowable Case Temperature vs. Average Forward Current

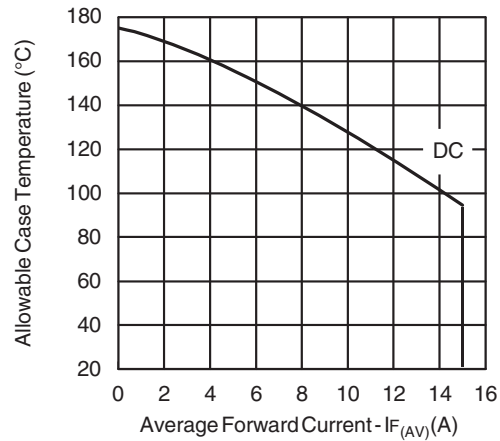

Fig. 7 - Maximum Allowable Case Temperature vs. Average Forward Current (FULL-PAK)

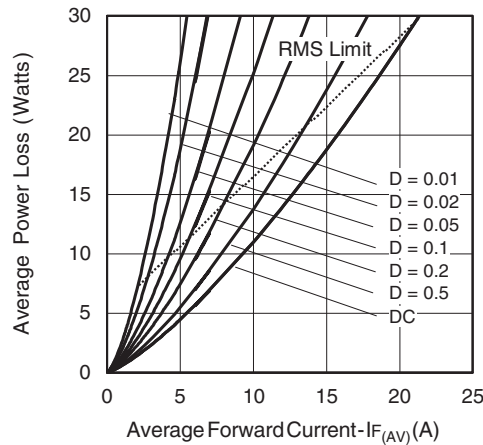

Fig. 8 - Forward Power Loss Characteristics

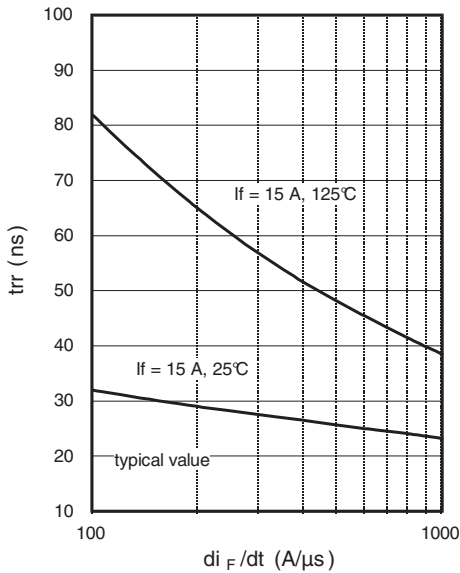

Fig. 9 - Typical Reverse Recovery vs.  $di_F/dt$

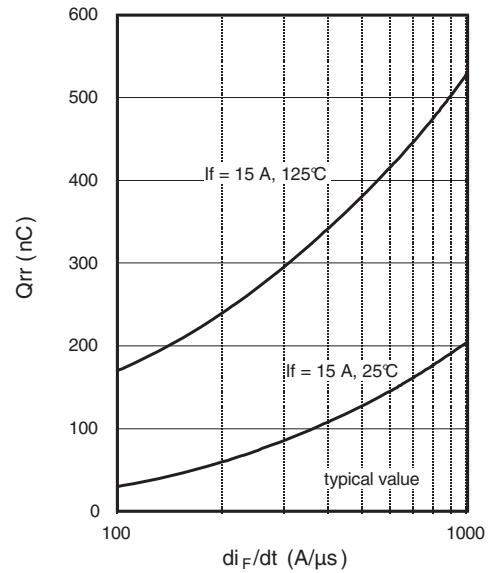
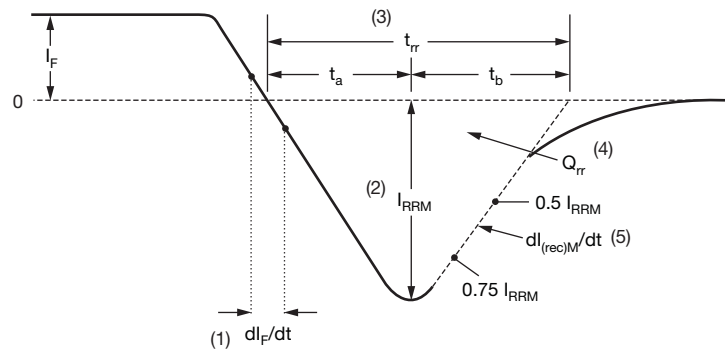

Fig. 10 - Typical Stored Charge vs.  $di_F/dt$



Fig. 11 - Reverse Recovery Parameter Test Circuit



- (1)  $di_F/dt$  - rate of change of current through zero crossing
- (2)  $I_{RRM}$  - peak reverse recovery current
- (3)  $t_{rr}$  - reverse recovery time measured from zero crossing point of negative going  $I_F$  to point where a line passing through  $0.75 I_{RRM}$  and  $0.50 I_{RRM}$  extrapolated to zero current.
- (4)  $Q_{rr}$  - area under curve defined by  $t_{rr}$  and  $I_{RRM}$
- (5)  $dl_{(rec)M}/dt$  - peak rate of change of current during  $t_b$  portion of  $t_{rr}$

$$Q_{rr} = \frac{t_{rr} \times I_{RRM}}{2}$$

Fig. 12 - Reverse Recovery Waveform and Definitions

# VS-ETH1506-M3, VS-ETH1506FP-M3

Vishay Semiconductors Hyperfast Rectifier, 15 A FRED Pt®



## ORDERING INFORMATION TABLE

Device code	<b>VS-</b>	<b>E</b>	<b>T</b>	<b>H</b>	<b>15</b>	<b>06</b>	<b>FP</b>	<b>-M3</b>
	①	②	③	④	⑤	⑥	⑦	⑧

- 1** - Vishay Semiconductors product
- 2** - Circuit configuration:  
E = Single diode
- 3** - T = TO-220
- 4** - H = Hyperfast recovery time
- 5** - Current code: 15 = 15 A
- 6** - Voltage code: 06 = 600 V
- 7** -
  - None = TO-220
  - FP = FULL-PAK
- 8** - Environmental digit:  
-M3 = Halogen-free, RoHS compliant and terminations lead (Pb)-free

ORDERING INFORMATION (Example)			
PREFERRED P/N	QUANTITY PER TUBE	MINIMUM ORDER QUANTITY	PACKAGING DESCRIPTION
VS-ETH1506-M3	50	1000	Antistatic plastic tube
VS-ETH1506FP-M3	50	1000	Antistatic plastic tube

LINKS TO RELATED DOCUMENTS		
Dimensions	2L TO-220AC	<a href="http://www.vishay.com/doc?95259">www.vishay.com/doc?95259</a>
	2L TO-220 FULL-PAK	<a href="http://www.vishay.com/doc?95260">www.vishay.com/doc?95260</a>
Part marking information	2L TO-220AC	<a href="http://www.vishay.com/doc?95391">www.vishay.com/doc?95391</a>
	2L TO-220 FULL-PAK	<a href="http://www.vishay.com/doc?95392">www.vishay.com/doc?95392</a>

### True 2 Pin TO-220

**DIMENSIONS** in millimeters and inches

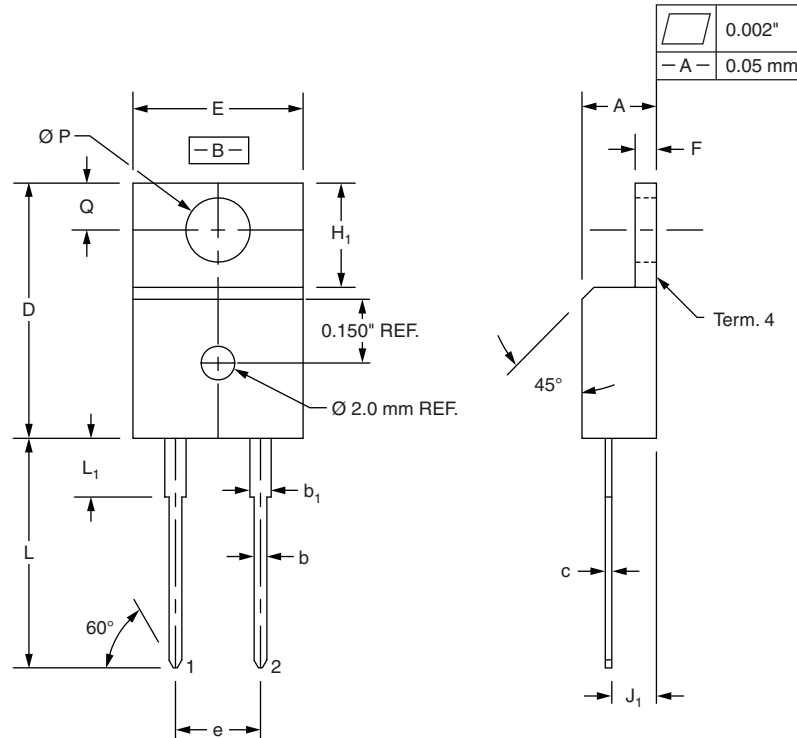

SYMBOL	MILLIMETERS		INCHES	
	MIN.	MAX.	MIN.	MAX.
A	4.32	4.57	0.170	0.180
b	0.71	0.91	0.028	0.036
b <sub>1</sub>	1.15	1.39	0.045	0.055
c	0.36	0.53	0.014	0.021
D	14.99	15.49	0.590	0.610
E	10.04	10.41	0.395	0.410
e	5.08 BSC		0.200 BSC	
F	1.22	1.37	0.048	0.054
H <sub>1</sub>	5.97	6.47	0.235	0.255
J <sub>1</sub>	2.54	2.79	0.100	0.110
L	13.47	13.97	0.530	0.550
L <sub>1</sub> <sup>(1)</sup>	3.31	3.81	0.130	0.150
Ø P	3.79	3.88	0.149	0.153
Q	2.60	2.84	0.102	0.112

**Notes**

<sup>(1)</sup> Lead dimension and finish uncontrolled in L<sub>1</sub>

- These dimensions are within allowable dimensions of JEDEC TO-220AB rev. J outline dated 3-24-87
- Controlling dimension: Inch



## True 2 Pin TO-220 FULL-PAK

**DIMENSIONS** in millimeters and inches



SYMBOL	MILLIMETERS		INCHES	
	MIN.	MAX.	MIN.	MAX.
A	4.53	4.93	0.178	0.194
b	0.71	0.91	0.028	0.036
b <sub>1</sub>	1.15	1.39	0.045	0.055
C	0.36	0.53	0.014	0.021
D	15.67	16.07	0.617	0.633
E	9.96	10.36	0.392	0.408
e	5.08 typical		0.200 typical	
F	2.34	2.74	0.092	0.107
H <sub>1</sub>	6.50	6.90	0.256	0.272
J <sub>1</sub>	2.56	2.96	0.101	0.117
L	12.78	13.18	0.503	0.519
L <sub>1</sub>	2.23	2.63	0.088	0.104
Ø Q	2.98	3.38	0.117	0.133
Q <sub>1</sub>	3.10	3.50	0.122	0.138
Q <sub>2</sub>	14.80	15.20	0.583	0.598
θ	0°	5°	0°	5°





## Disclaimer

ALL PRODUCT, PRODUCT SPECIFICATIONS AND DATA ARE SUBJECT TO CHANGE WITHOUT NOTICE TO IMPROVE RELIABILITY, FUNCTION OR DESIGN OR OTHERWISE.

Vishay Intertechnology, Inc., its affiliates, agents, and employees, and all persons acting on its or their behalf (collectively, "Vishay"), disclaim any and all liability for any errors, inaccuracies or incompleteness contained in any datasheet or in any other disclosure relating to any product.

Vishay makes no warranty, representation or guarantee regarding the suitability of the products for any particular purpose or the continuing production of any product. To the maximum extent permitted by applicable law, Vishay disclaims (i) any and all liability arising out of the application or use of any product, (ii) any and all liability, including without limitation special, consequential or incidental damages, and (iii) any and all implied warranties, including warranties of fitness for particular purpose, non-infringement and merchantability.

Statements regarding the suitability of products for certain types of applications are based on Vishay's knowledge of typical requirements that are often placed on Vishay products in generic applications. Such statements are not binding statements about the suitability of products for a particular application. It is the customer's responsibility to validate that a particular product with the properties described in the product specification is suitable for use in a particular application. Parameters provided in datasheets and/or specifications may vary in different applications and performance may vary over time. All operating parameters, including typical parameters, must be validated for each customer application by the customer's technical experts. Product specifications do not expand or otherwise modify Vishay's terms and conditions of purchase, including but not limited to the warranty expressed therein.

Except as expressly indicated in writing, Vishay products are not designed for use in medical, life-saving, or life-sustaining applications or for any other application in which the failure of the Vishay product could result in personal injury or death. Customers using or selling Vishay products not expressly indicated for use in such applications do so at their own risk. Please contact authorized Vishay personnel to obtain written terms and conditions regarding products designed for such applications.

No license, express or implied, by estoppel or otherwise, to any intellectual property rights is granted by this document or by any conduct of Vishay. Product names and markings noted herein may be trademarks of their respective owners.

## Material Category Policy

**Vishay Intertechnology, Inc. hereby certifies that all its products that are identified as RoHS-Compliant fulfill the definitions and restrictions defined under Directive 2011/65/EU of The European Parliament and of the Council of June 8, 2011 on the restriction of the use of certain hazardous substances in electrical and electronic equipment (EEE) - recast, unless otherwise specified as non-compliant.**

**Please note that some Vishay documentation may still make reference to RoHS Directive 2002/95/EC. We confirm that all the products identified as being compliant to Directive 2002/95/EC conform to Directive 2011/65/EU.**

**Vishay Intertechnology, Inc. hereby certifies that all its products that are identified as Halogen-Free follow Halogen-Free requirements as per JEDEC JS709A standards. Please note that some Vishay documentation may still make reference to the IEC 61249-2-21 definition. We confirm that all the products identified as being compliant to IEC 61249-2-21 conform to JEDEC JS709A standards.**

## Данный компонент на территории Российской Федерации

### Вы можете приобрести в компании MosChip.

Для оперативного оформления запроса Вам необходимо перейти по данной ссылке:

<http://moschip.ru/get-element>

Вы можете разместить у нас заказ для любого Вашего проекта, будь то серийное производство или разработка единичного прибора.

В нашем ассортименте представлены ведущие мировые производители активных и пассивных электронных компонентов.

Нашей специализацией является поставка электронной компонентной базы двойного назначения, продукции таких производителей как XILINX, Intel (ex.ALTERA), Vicor, Microchip, Texas Instruments, Analog Devices, Mini-Circuits, Amphenol, Glenair.

Сотрудничество с глобальными дистрибьюторами электронных компонентов, предоставляет возможность заказывать и получать с международных складов практически любой перечень компонентов в оптимальные для Вас сроки.

На всех этапах разработки и производства наши партнеры могут получить квалифицированную поддержку опытных инженеров.

Система менеджмента качества компании отвечает требованиям в соответствии с ГОСТ Р ИСО 9001, ГОСТ РВ 0015-002 и ЭС РД 009

### Офис по работе с юридическими лицами:

105318, г.Москва, ул.Щербаковская д.3, офис 1107, 1118, ДЦ «Щербаковский»

Телефон: +7 495 668-12-70 (многоканальный)

Факс: +7 495 668-12-70 (доб.304)

E-mail: [info@moschip.ru](mailto:info@moschip.ru)

Skype отдела продаж:

moschip.ru

moschip.ru\_4

moschip.ru\_6

moschip.ru\_9