

Features

- ID1 full size card acceptance
- Card detection sealed switch
- Compatible with pick and place and lead free soldering

Typical Applications

- Transaction
- POS
- Identification



Mechanical

Number of contacts	6 or 8
Mechanical life	50,000 cycles
Card insertion force	10N max
Card extraction force	1N min / 10N max
Contact force	0,4N to 0,7N
Card detection switch	0,8 N max for actuation (end travel switch actuation force actuates when card is 0,9mm from card stop)
	1,8 N max for complete depression
Vibration Frequency	10 to 500 Hz. Acceleration 50m/s ² Duration 6 hours - amplitude 0,35mm
Shock	Peak value 500 m/s ² – Duration 11 ms 3 shocks in each direction of each axis
Max elect. discontinuity	1µs

Packaging

See table below

Soldering Process

Compatible with lead free SMT reflow soldering process

Contact Electrical Data

Insulation resistance	1000 MΩ min
Contact resistance max	100 mΩ max
Switching current	10 µA min / 1 A max
Dielectric strength	750 Vrms min

Switch Electrical Data

Card detection switch	Normally open
Rc card detection switch	100 mΩ max
Dielectric strength	250 Vrms min
Switch current rating	1 mA min / 10 mA max
Maximum switch power	0.2 VA

Environmental Data

Operating temperature	-40°C to +85°C
Salt mist	IEC 512 test number 11f (96 hours)
Damp heat	IEC 512 test number 11c (10 days)
Card detection switch	Sealed against dust
RoHS compliant	

Designation	Housing Type	# of Contacts	Contact Force	Total Height (mm)	Total Dim. (mm)	Packaging
CCM04-5427LFT	standard	8	0,4N to 0,7N	2,65	18,75 X 25	reels of 1,000 pcs
CCM04-5436LFT	standard	8	0,4N to 0,7N	0,90	18,75 X 26,9	reels of 1,000 pcs
CCM04-5468LFT	stand-off	8	0,4N to 0,7N	3,5	18,75 X 24	reels of 1,000 pcs
CCM04-5454LFT	standard	8	0,4N to 0,7N	0,90	18,75 X 26,9	reels of 1,000 pcs
CCM04-5455LFT	standard	8	0,4N to 0,7N	0,90	18,75 X 26,9	reels of 1,000 pcs

CCM04 MK4 Series

CCM04-5427 LFT

Full Size

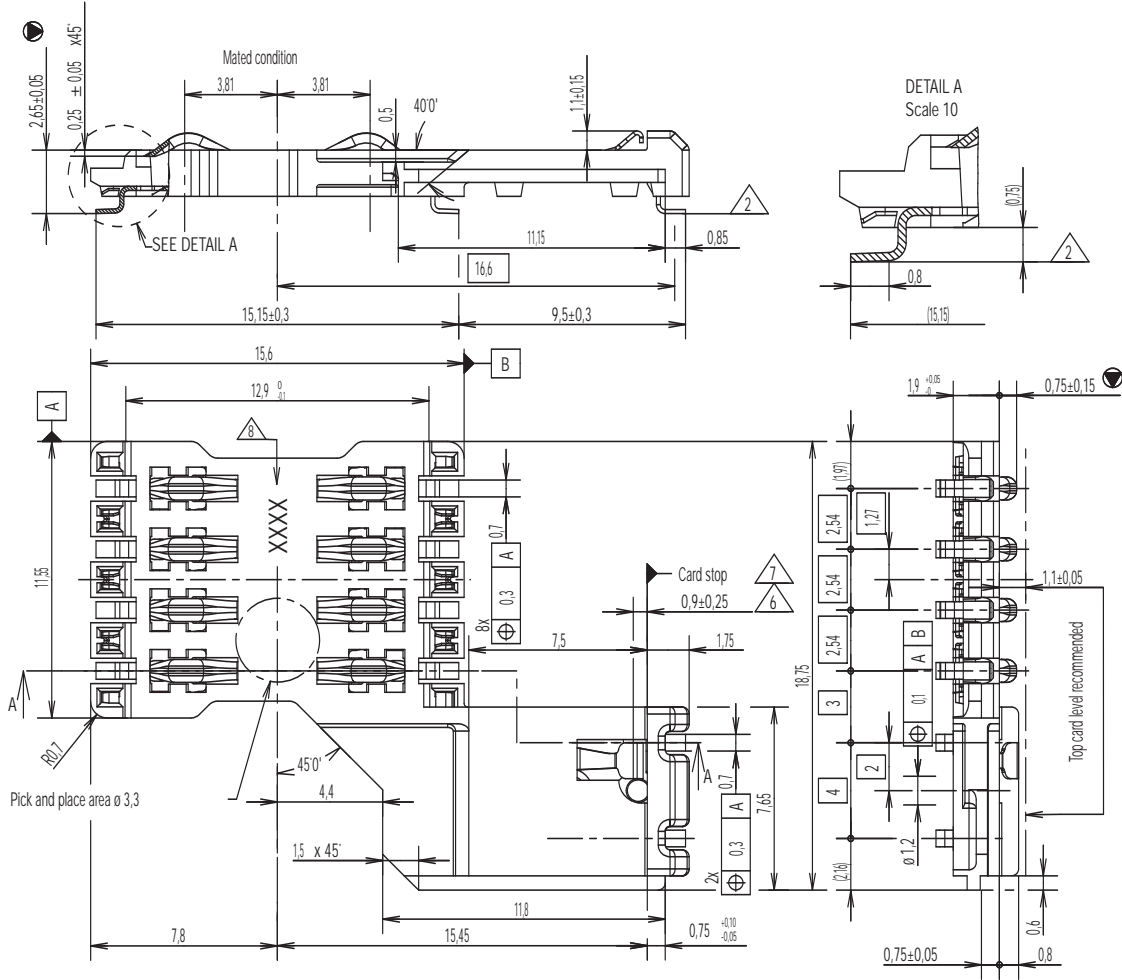

RECOMMENDED PC BOARD LAYOUT
(Component side)

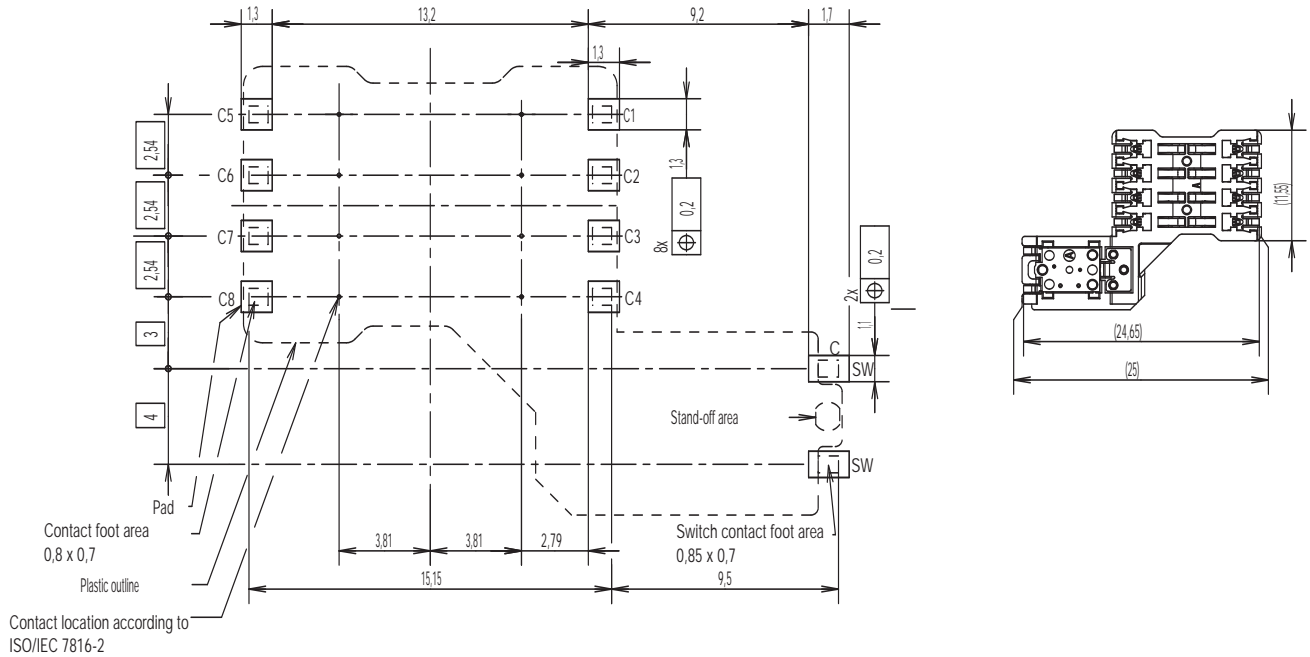

Dimensions are shown in mm
Specifications and dimensions subject to change

www.ck-components.com

CCM04 MK4 Series

CCM04-5436 LFT

Full Size

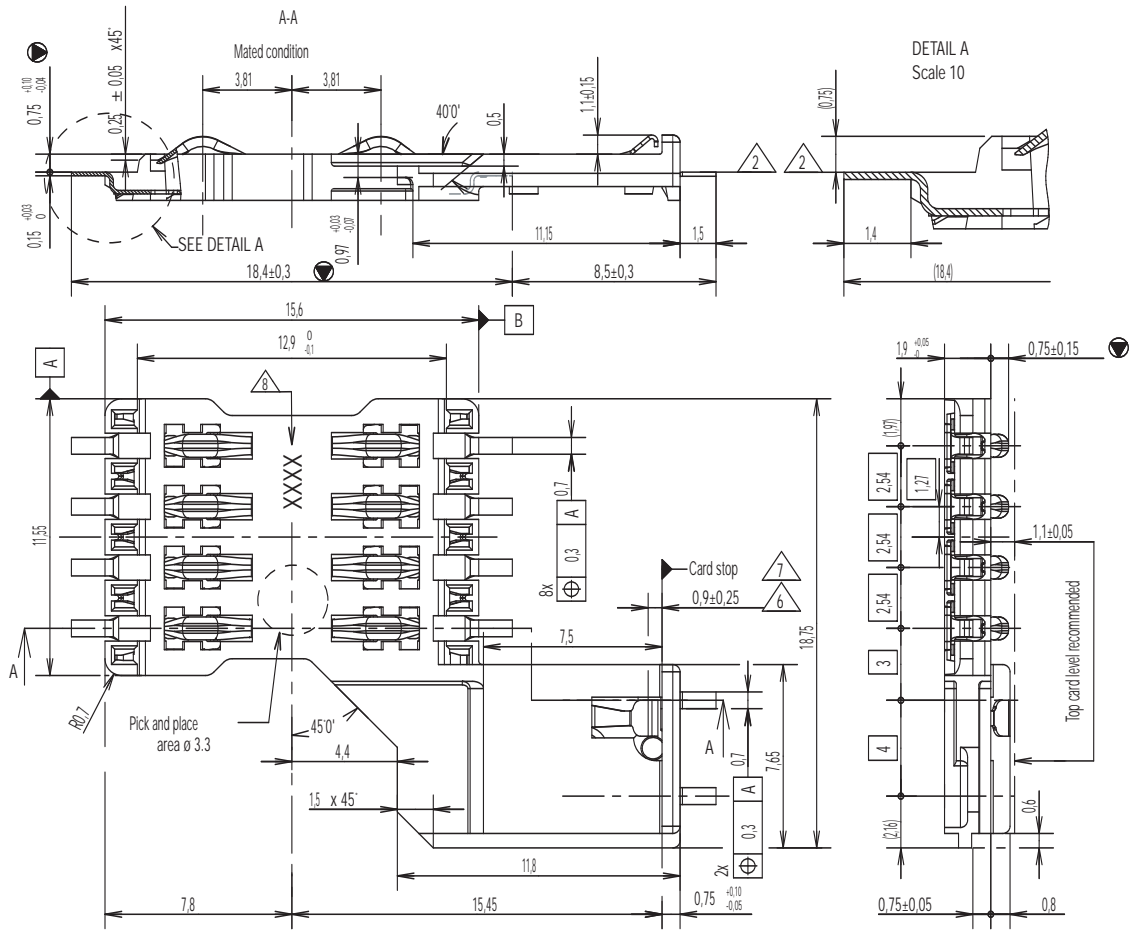

RECOMMENDED PC BOARD LAYOUT
(Component side)

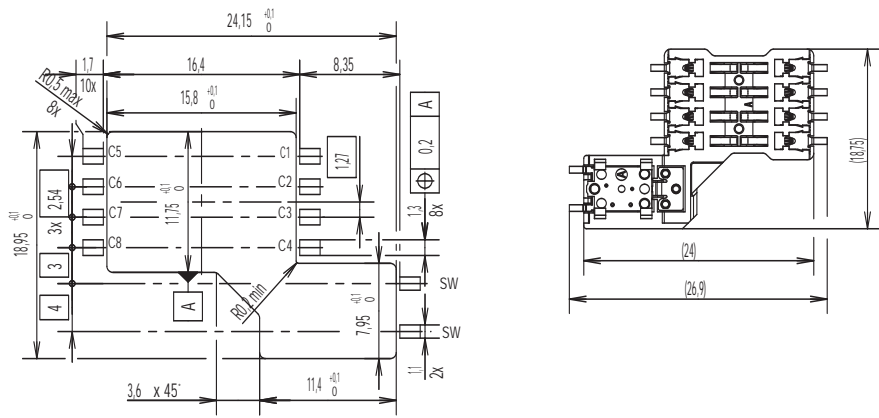

Dimensions are shown in mm
Specifications and dimensions subject to change

www.ck-components.com

CCM04 MK4 Series

CCM04-5468 LFT

Full Size

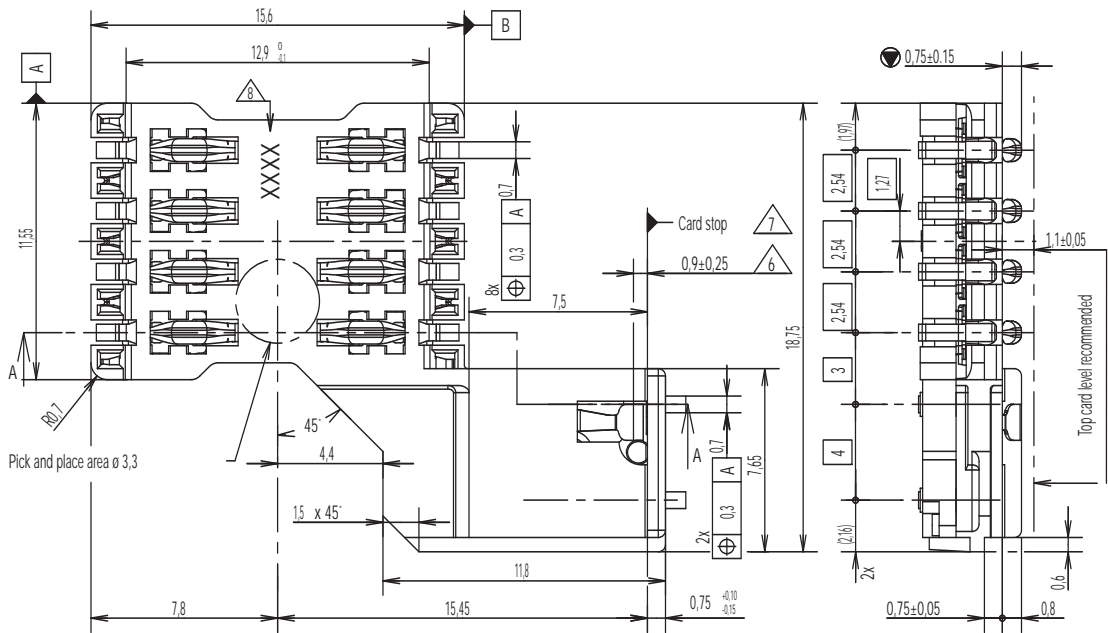
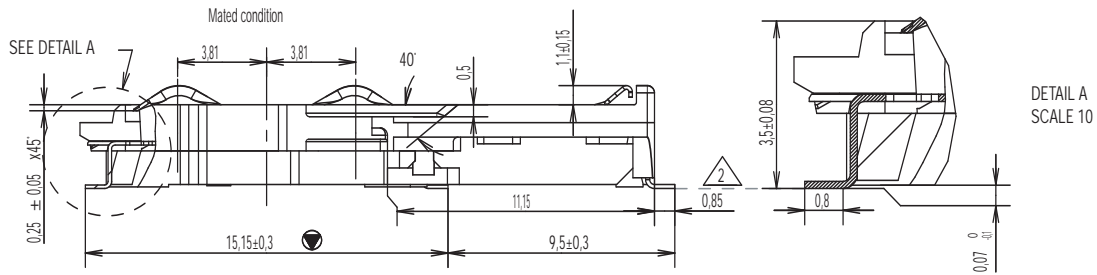

RECOMMENDED PC BOARD LAYOUT
(Component side)

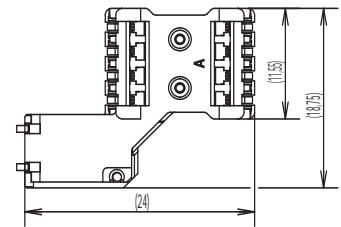
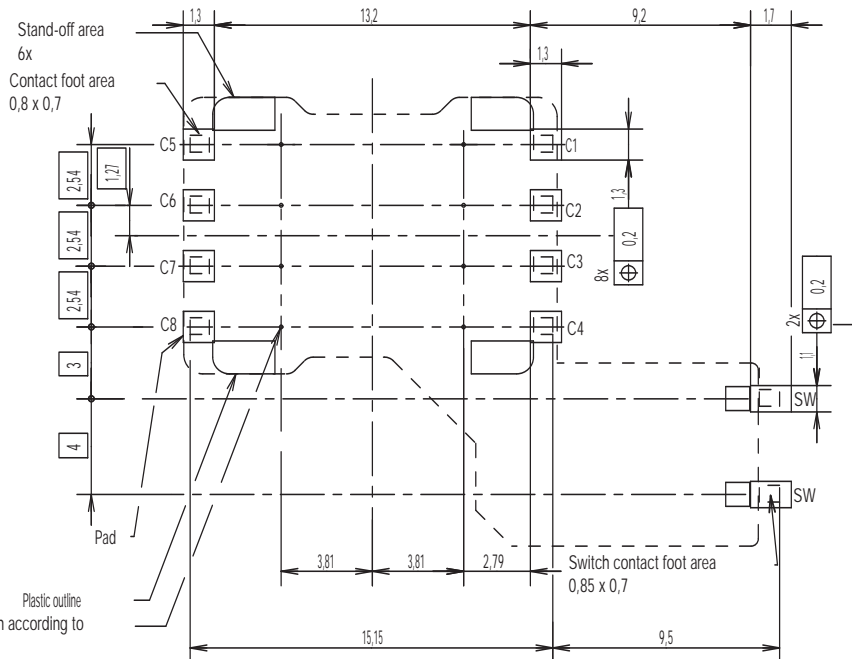

Plastic outline
Contact location according to
ISO/IEC 7816-2

First Angle
Projection



Dimensions are shown in mm
Specifications and dimensions subject to change

www.ck-components.com

CCM04 MK4 Series

CCM04-5454 LFT

Full Size

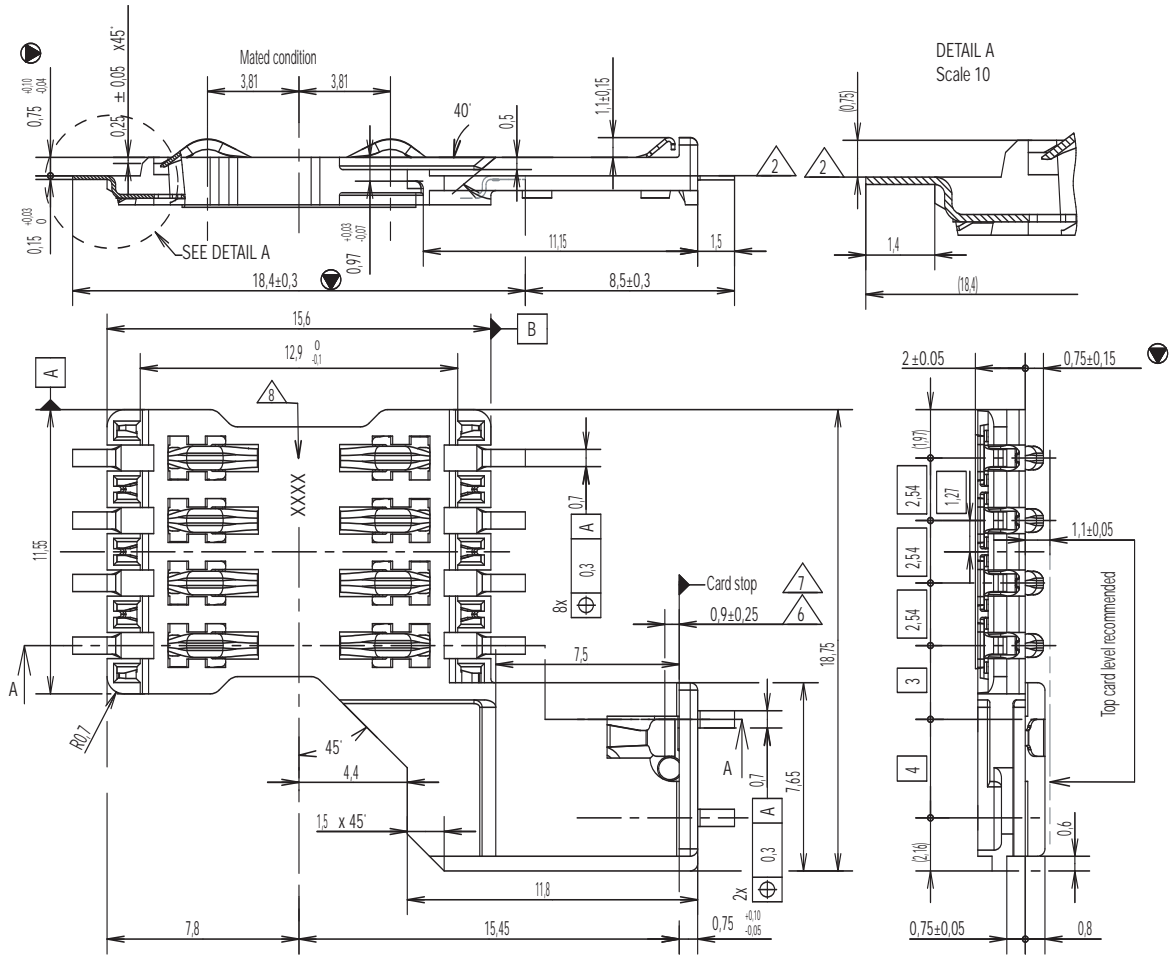

RECOMMENDED PC BOARD LAYOUT
(Component side)
Scale 2,5

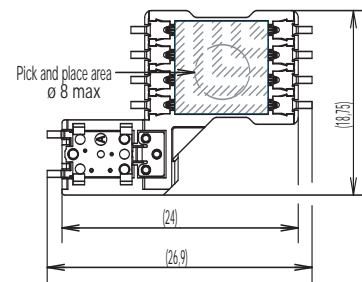
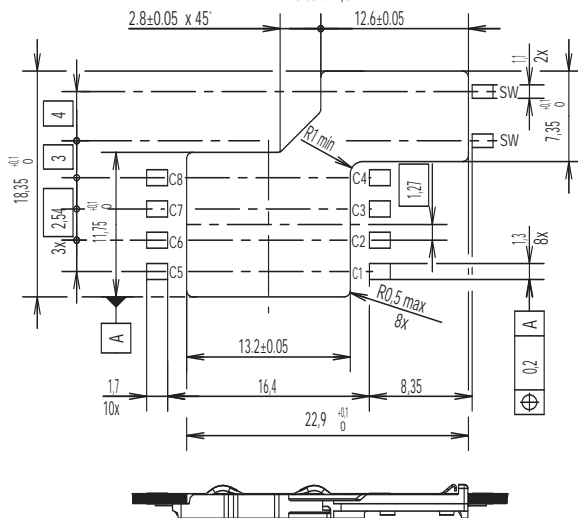

Dimensions are shown in mm
Specifications and dimensions subject to change

www.ck-components.com

CCM04 MK4 Series

CCM04-5455 LFT

Full Size

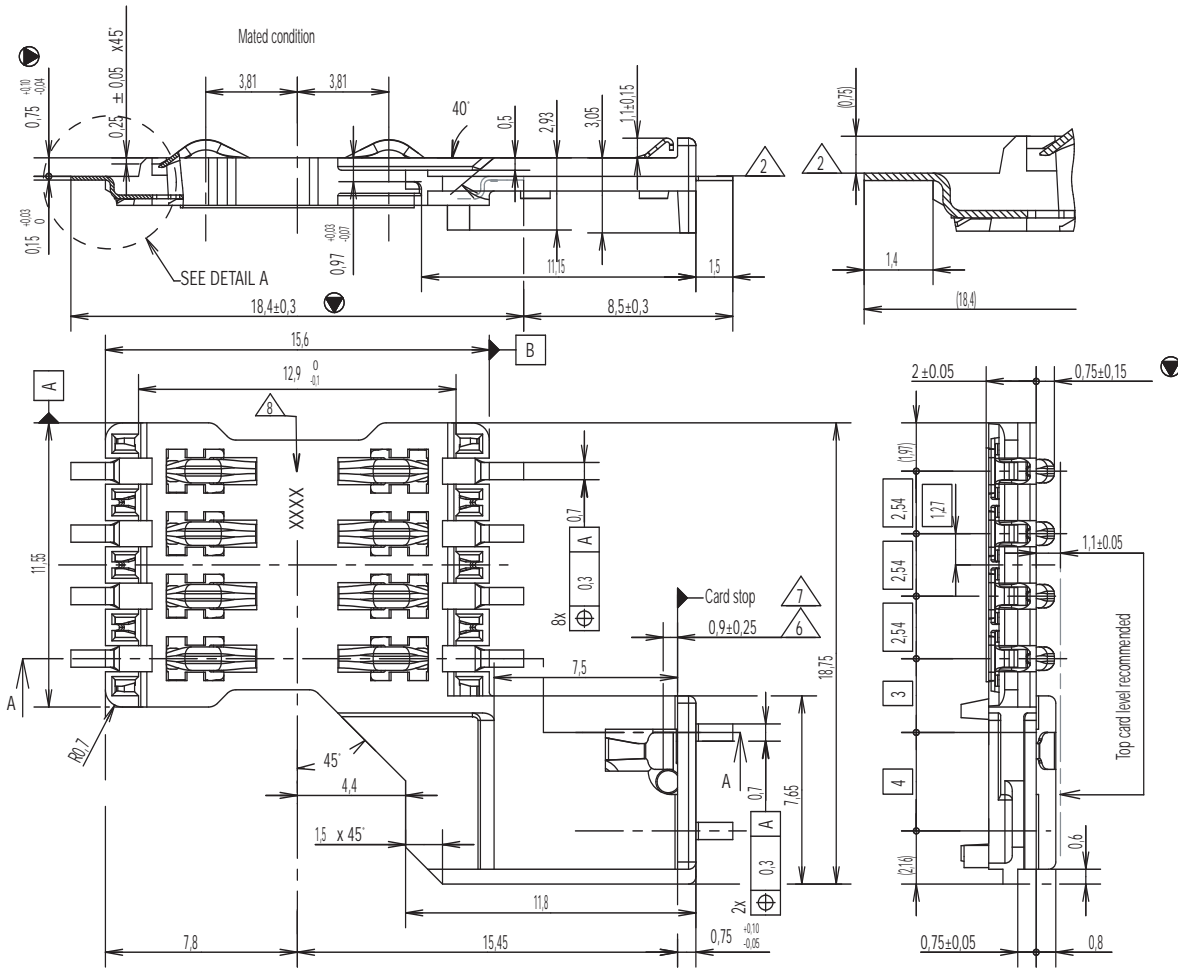

RECOMMENDED PC BOARD LAYOUT
(Component side)

Scale 2,5

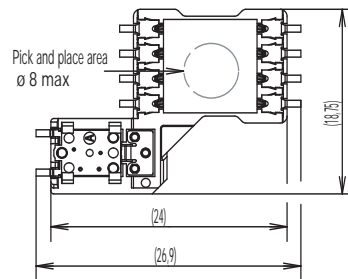
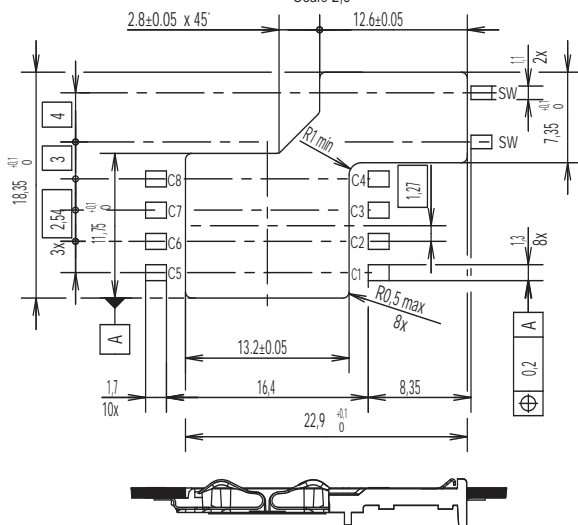

Dimensions are shown in mm
Specifications and dimensions subject to change

www.ck-components.com

Данный компонент на территории Российской Федерации

Вы можете приобрести в компании MosChip.

Для оперативного оформления запроса Вам необходимо перейти по данной ссылке:

<http://moschip.ru/get-element>

Вы можете разместить у нас заказ для любого Вашего проекта, будь то серийное производство или разработка единичного прибора.

В нашем ассортименте представлены ведущие мировые производители активных и пассивных электронных компонентов.

Нашей специализацией является поставка электронной компонентной базы двойного назначения, продукции таких производителей как XILINX, Intel (ex.ALTERA), Vicor, Microchip, Texas Instruments, Analog Devices, Mini-Circuits, Amphenol, Glenair.

Сотрудничество с глобальными дистрибьюторами электронных компонентов, предоставляет возможность заказывать и получать с международных складов практически любой перечень компонентов в оптимальные для Вас сроки.

На всех этапах разработки и производства наши партнеры могут получить квалифицированную поддержку опытных инженеров.

Система менеджмента качества компании отвечает требованиям в соответствии с ГОСТ Р ИСО 9001, ГОСТ РВ 0015-002 и ЭС РД 009

Офис по работе с юридическими лицами:

105318, г.Москва, ул.Щербаковская д.3, офис 1107, 1118, ДЦ «Щербаковский»

Телефон: +7 495 668-12-70 (многоканальный)

Факс: +7 495 668-12-70 (доб.304)

E-mail: info@moschip.ru

Skype отдела продаж:

moschip.ru

moschip.ru_4

moschip.ru_6

moschip.ru_9