

5.Style and Dimensions

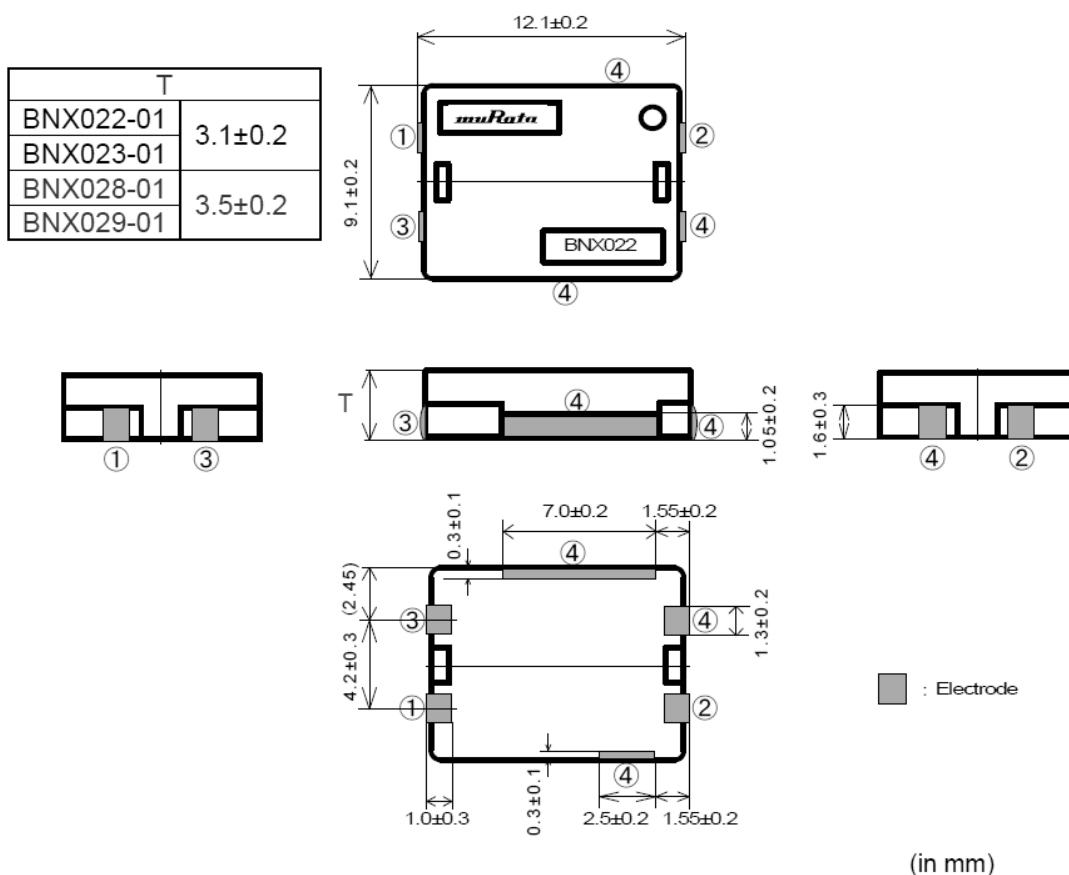

※Coplanarity 0.10mm max

■Equivalent Circuit

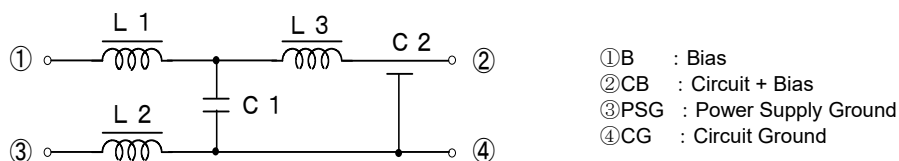

■ Unit Mass (Typical value)

0.80g

6.Marking

Filter shall be marked as follows.

- (1) Murata Mark : **muRata**
- (2) Part Number : BNX022-01 : (BNX022)
- BNX023-01 : (BNX023)
- BNX028-01 : (BNX028)
- BNX029-01 : (BNX029)
- (3) Polarity Marking : ○

7.Electrical Performance

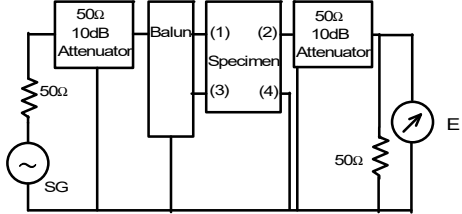
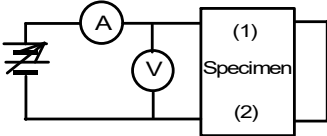
No.	Item	Specification	Test Method
7.1	Insertion Loss	Meet item 3.	 <p>*Method of measurement based on MIL-STD-220 Insertion Loss = $-20 \log E_1/E_0$ (dB) E₀ : Level without FILTER (short) E₁: Level with FILTER</p>
7.2	Capacitance		Measured by the following condition between Terminal ①② and ③④. (see item 5.) Frequency : 1 ± 0.1kHz (BNX022/BNX023) 120±24Hz (BNX028/BNX029) Voltage : 1 V(rms) max. (BNX022/BNX023) 0.5±0.1V(rms). (BNX028/BNX029) Measuring Equipment : Agilent4278A or the equivalent (BNX022/BNX023) Agilent4284A or the equivalent (BNX028/BNX029)
7.3	DC Resistance		Measured by the way of 4 terminal method between ① and ② and between ③ and ④. (see item 5.)
7.4	Insulation Resistance		Measured at DC rated voltage between terminal ①② and ③④. (see item 5.) Time : 60 s max Charging current : 50 mA max. Measuring Equipment : R8340A or the equivalent
7.5	Withstanding Voltage	Filter shall be no failure.	Withstanding voltage shall be applied between terminal ①② and ③④. (see item 5.) Test Voltage : BNX022-01 125V(DC) BNX023-01 250 V(DC) BNX028-01 40 V(DC) BNX029-01 15.8 V(DC) Time : 5 ± 1 s Charging current : 50 mA max.
7.6	Voltage Drop	Meet item 3.	After soldering the part on the test substrate, measure the voltage with passing the rated current as shown in the schematic below.  <p>Where the terminals of the part shall be connected as follows: Referring to the terminal No. shown in item 5, connect terminal No. ② and ④ by soldering copper wire with diameter more than 1mm / length less than 6mm. Then connect terminal No. ① as (1) and terminal No. ③ as (2) the measurement circuit as mentioned above. The probe for measuring the voltage shall be touched on the solder fillet of ①③.</p>

8.Mechanical Performance

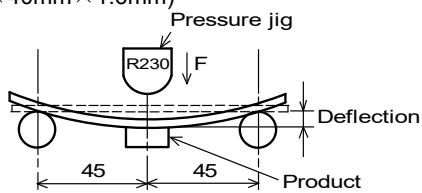
No.	Item	Specification	Test Method																
8.1	Appearance and Dimensions	Meet item 5.	Visual Inspection and measured with Micrometer caliper and Slide Caliper.																
8.2	Marking	Meet item 5.	Visual Inspection																
8.3	Reflow Solderability	Appropriate solder fillet is formed.	It shall be soldered with the Standard Profile condition as shown No.13.6(2) Soldering Condition. · thickness of solder paste : 150 to 200 μm · Land dimension : see No.13.5.																
8.4	Resistance to soldering iron	Meet Table 1. <u>Table 1</u> <table border="1" style="width: 100%; border-collapse: collapse;"> <tr> <td>Appearance</td> <td colspan="2">No damaged</td> </tr> <tr> <td rowspan="4">Cap.Change</td> <td>BNX022</td> <td rowspan="2">within ±7.5%</td> </tr> <tr> <td>BNX023</td> </tr> <tr> <td>BNX028</td> <td rowspan="2">within ±15%</td> </tr> <tr> <td>BNX029</td> </tr> <tr> <td>I.R.</td> <td colspan="2">meet item 3</td> </tr> <tr> <td>Dielectric Strength</td> <td colspan="2">No failure</td> </tr> </table>	Appearance	No damaged		Cap.Change	BNX022	within ±7.5%	BNX023	BNX028	within ±15%	BNX029	I.R.	meet item 3		Dielectric Strength	No failure		Soldering iron : 100 W max. Tip Temperature : 450 °C ± 5 °C Soldering Time : 5 s , 2 Times Do not touch the products directly with the tip of the soldering iron. <About BNX028,BNX029> · Initial values: measured after heat treatment (150± ⁰ ₁₀ °C, 1hour) and exposure in the room condition for 24±2 hours. · Values After Testing:measured after heat treatment (150± ⁰ ₁₀ °C, 1hour) and exposure in the room condition for 24±2 hours.
Appearance	No damaged																		
Cap.Change	BNX022	within ±7.5%																	
	BNX023																		
	BNX028	within ±15%																	
	BNX029																		
I.R.	meet item 3																		
Dielectric Strength	No failure																		
8.5	Bending Strength		It shall be soldered on the glass-epoxy substrate. (100mm×40mm×1.6mm) <div style="text-align: center;">  </div> Deflection : 2 mm Keeping Time : 30 s Speed : 0.5 mm/s <About BNX028,BNX029> · Initial values: measured after heat treatment (150± ⁰ ₁₀ °C, 1hour) and exposure in the room condition for 24±2 hours. · Values After Testing:measured after heat treatment (150± ⁰ ₁₀ °C, 1hour) and exposure in the room condition for 24±2 hours.																
8.6	Drop	Meet Table 2. <u>Table 2</u> <table border="1" style="width: 100%; border-collapse: collapse;"> <tr> <td>Appearance</td> <td>No damaged</td> </tr> <tr> <td>Cap.Change</td> <td>within ±15%</td> </tr> <tr> <td>I.R.</td> <td>meet item 3</td> </tr> <tr> <td>Dielectric Strength</td> <td>No failure</td> </tr> </table>	Appearance	No damaged	Cap.Change	within ±15%	I.R.	meet item 3	Dielectric Strength	No failure	It shall be dropped on concrete or steel board. Method : free fall Height : 1 m The Number of Time : 10 times <About BNX028,BNX029> · Initial values: measured after heat treatment (150± ⁰ ₁₀ °C, 1hour) and exposure in the room condition for 24±2 hours. · Values After Testing:measured after heat treatment (150± ⁰ ₁₀ °C, 1hour) and exposure in the room condition for 24±2 hours.								
Appearance	No damaged																		
Cap.Change	within ±15%																		
I.R.	meet item 3																		
Dielectric Strength	No failure																		

No.	Item	Specification	Test Method																					
9.2	Humidity Life ①	Meet Table 3. Table 3 <table border="1"> <thead> <tr> <th>Appearance</th> <th colspan="2">No damaged</th> </tr> </thead> <tbody> <tr> <td rowspan="4">Cap.Change</td> <td>BNX022</td> <td>within</td> </tr> <tr> <td>BNX023</td> <td>±12.5%</td> </tr> <tr> <td>BNX028</td> <td>within</td> </tr> <tr> <td>BNX029</td> <td>±15%</td> </tr> <tr> <td rowspan="4">I.R.</td> <td>BNX022</td> <td>25MΩ</td> </tr> <tr> <td>BNX023</td> <td>min.</td> </tr> <tr> <td>BNX028</td> <td>0.11M Ω min.</td> </tr> <tr> <td>BNX029</td> <td>0.05MΩ min.</td> </tr> </tbody> </table>	Appearance	No damaged		Cap.Change	BNX022	within	BNX023	±12.5%	BNX028	within	BNX029	±15%	I.R.	BNX022	25MΩ	BNX023	min.	BNX028	0.11M Ω min.	BNX029	0.05MΩ min.	Temperature : 60 ± 2 °C Humidity : 90 ~ 95 %(RH) Voltage : Rated Voltage Time : 1000 h (+ 48h , - 0h) Then measure values after exposure in the room condition for 48 ± 4 hours. <About BNX028,BNX029> · Initial values: measured after heat treatment ($150 \pm 0_{10}$ °C, 1hour) and exposure in the room condition for 24 ± 2 hours. · Values After Testing:measured after heat treatment ($150 \pm 0_{10}$ °C, 1hour) and exposure in the room condition for 24 ± 2 hours.
	Appearance	No damaged																						
Cap.Change	BNX022	within																						
	BNX023	±12.5%																						
	BNX028	within																						
	BNX029	±15%																						
I.R.	BNX022	25MΩ																						
	BNX023	min.																						
	BNX028	0.11M Ω min.																						
	BNX029	0.05MΩ min.																						
Humidity Life ②		Temperature : 85 ± 2 °C Humidity : 80 ~ 85 %(RH) Voltage : Rated Voltage Time : 1000 h (+ 48h , - 0h) Then measure values after exposure in the room condition for 48 ± 4 hours. <About BNX028,BNX029> · Initial values: measured after heat treatment ($150 \pm 0_{10}$ °C, 1hour) and exposure in the room condition for 24 ± 2 hours. · Values After Testing:measured after heat treatment ($150 \pm 0_{10}$ °C, 1hour) and exposure in the room condition for 24 ± 2 hours.																						
9.3	Heat Life	Meet Table 4. Table 4 <table border="1"> <thead> <tr> <th>Appearance</th> <th colspan="2">No damaged</th> </tr> </thead> <tbody> <tr> <td rowspan="4">Cap.Change</td> <td>BNX022</td> <td>within</td> </tr> <tr> <td>BNX023</td> <td>±12.5%</td> </tr> <tr> <td>BNX028</td> <td>within</td> </tr> <tr> <td>BNX029</td> <td>±15%</td> </tr> <tr> <td rowspan="4">I.R.</td> <td>BNX022</td> <td>50MΩ</td> </tr> <tr> <td>BNX023</td> <td>min.</td> </tr> <tr> <td>BNX028</td> <td>0.11M Ω min.</td> </tr> <tr> <td>BNX029</td> <td>0.05MΩ min.</td> </tr> </tbody> </table>	Appearance	No damaged		Cap.Change	BNX022	within	BNX023	±12.5%	BNX028	within	BNX029	±15%	I.R.	BNX022	50MΩ	BNX023	min.	BNX028	0.11M Ω min.	BNX029	0.05MΩ min.	Temperature : 125 ± 2 °C Voltage : Rated Voltage $\times 2$ Time : 1000 h (+ 48h , - 0h) Then measure values after exposure in the room condition for 48 ± 4 hours. <About BNX028,BNX029> · Initial values: measured after heat treatment ($150 \pm 0_{10}$ °C, 1hour) and exposure in the room condition for 24 ± 2 hours. · Values After Testing:measured after heat treatment ($150 \pm 0_{10}$ °C, 1hour) and exposure in the room condition for 24 ± 2 hours.
Appearance	No damaged																							
Cap.Change	BNX022	within																						
	BNX023	±12.5%																						
	BNX028	within																						
	BNX029	±15%																						
I.R.	BNX022	50MΩ																						
	BNX023	min.																						
	BNX028	0.11M Ω min.																						
	BNX029	0.05MΩ min.																						

10.Insertion Loss Characteristics (I.L.) (Typ.)

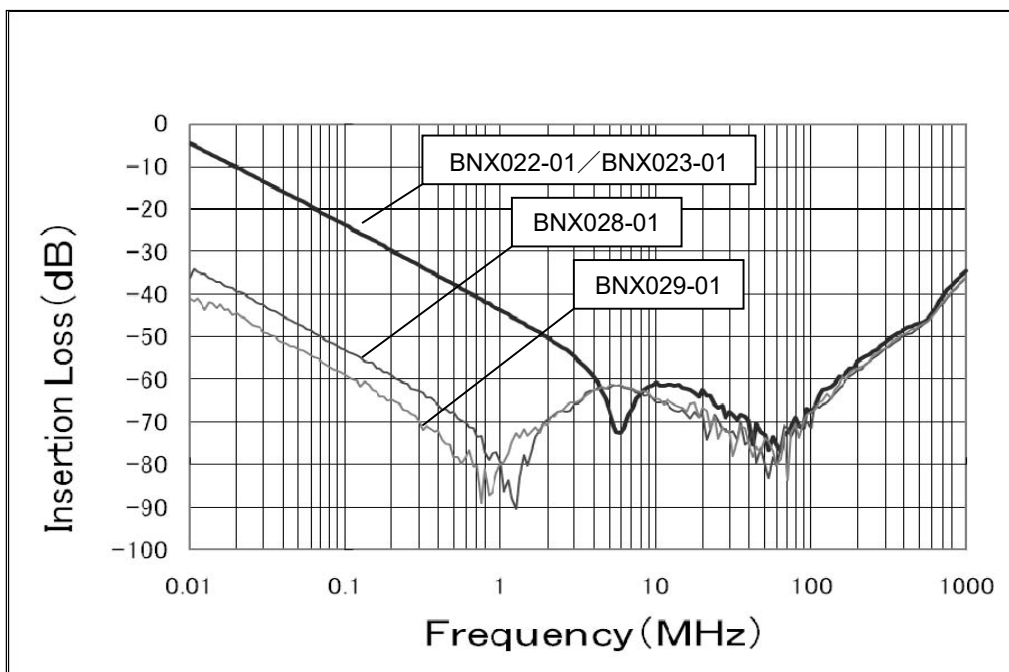

11. Specification of Packaging

11.1 Appearance and Dimensions (24mm-wide plastic tape)

(1) plastic tape

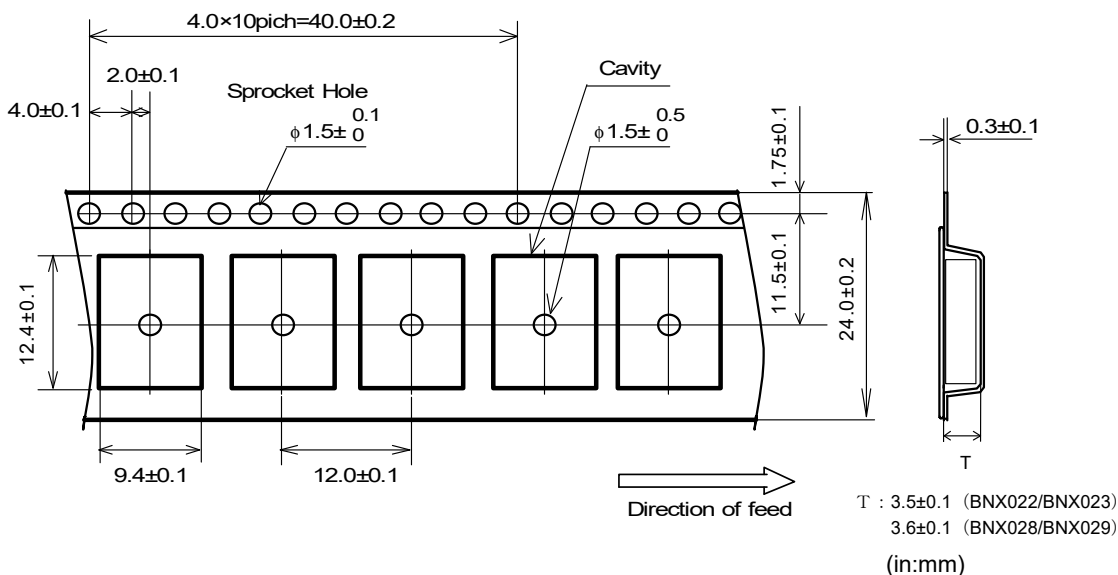

*Dimension of the Cavity is measured at the bottom side.

(2)Direction of the product

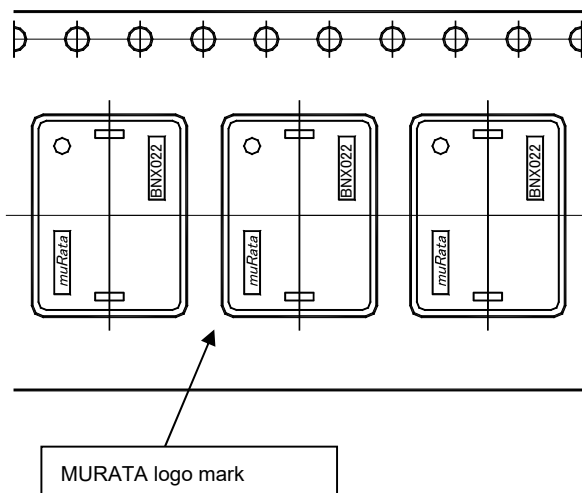

11.2 Specification of Taping

- (1) Packing quantity (standard quantity)
 - φ178mm reel : 400 pcs. / reel
 - φ330mm reel : 1500 pcs. / reel
- (2) Packing Method
 - Products shall be packaged in the cavity of the plastic tape and sealed with cover tape.
- (3) Spliced point
 - The cover tape have no spliced point.
- (4) Sprocket Hole
 - The sprocket holes are to the right as the tape is pulled toward the user.
- (5) Missing components number
 - Missing components number within 0.1% of the number per reel or 1 pc., whichever is greater, and are not continuous. The specified quantity per reel is kept.

11.3 Pull Strength of Plastic Tape and Cover Tape

Plastic tape	10N min.
Cover tape	

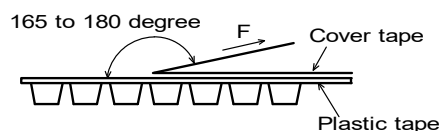

11.4 Peeling off force of Cover tape

0.2N to 0.7N (minimum value is typical)
 * Speed of Peeling off : 300 mm / min

11.7 Marking for Outside package (corrugated paper box)

Customer name, Purchasing Order Number, Customer Part Number, MURATA part number, RoHS discrimination(□*2) , Quantity , etc

11.8 Specification of Outer Case

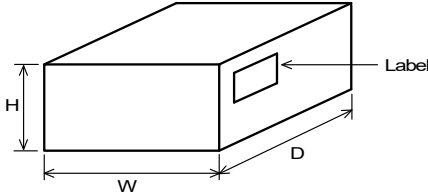

Reel	Outer Case Dimensions (mm)			Standard Reel Quantity in Outer Case (Reel)
	W	D	H	
φ178mm	186	186	93	3
φ330mm	340	340	85	2

* Above Outer Case size is typical. It depends on a quantity of an order.

12. ⚠ Caution

12.1.Direction of mounting

Please make sure of the direction of mounting and connect to the circuit properly.
 As shown in the equivalent circuit shown in item 5, this product has a directionality.
 Wrong connection to the circuit may cause open/short circuit of the part, burnout and serious accidents.

12.2.Limitation of Applications

Please contact us before using our products for the applications listed below which require especially high reliability for the prevention of defects which might directly cause damage to the third party's life,body or property.
 (1)Aircraft equipment (2)Aerospace equipment (3)Undersea equipment (4)Power plant control equipment
 (5)Medical equipment (6)Transportation equipment(automobiles,trains,ships,etc.) (7)Traffic signal equipment
 (8)Disaster prevention / crime prevention equipment (9)Data-processing equipment
 (10)Applications of similar complexity or with reliability requirements comparable to the applications listed in the above

12.3.ESD

ESD to this product, exceeding condition of IEC61000-4-2 with 30kV, may cause short circuit and fuming or firing.

13.Notice

Products can only be soldered with reflow.
 This product is designed for solder mounting.
 Please consult us in advance for applying other mounting method such as conductive adhesive.

13.1. Flux and Solder

Flux	Use rosin-based flux, Do not use highly acidic flux (with chlorine content exceeding 0.2(wt)%). Do not use water soluble flux.
Solder	Use Sn-3.0Ag-0.5Cu solder

Other flux (except above) Please contact us for details, then use.

13.2. Note for Assembling

- <Exclusive Use of Reflow Soldering>
 - When installing by the flow soldering, the degradation of the insulation resistance sometimes occurs.
 - Products can only be soldered with reflow.
 - The use in flow soldering be reserved.
- < Thermal Shock >
 - Pre-heating should be in such a way that the temperature difference between solder and products surface is limited to 100 °C max. Also cooling into solvent after soldering should be in such a way that the temperature difference is limited to 100 °C max.
 - Insufficient pre-heating may cause cracks on the ferrite, resulting in the deterioration of product quality.

13.3. Attention Regarding P.C.B. Bending

The following shall be considered when designing P.C.B.'s and laying out products.

- (1) P.C.B. shall be designed so that products are not subject to the mechanical stress for board warpage.

[Products direction]

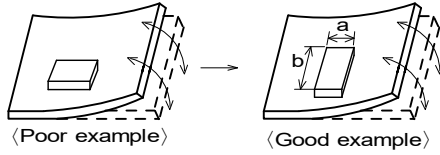

Products shall be located in the sideways direction (Length: $a < b$) to the mechanical stress.

- (2) Products location on P.C.B. near seam for separation.

Products (A,B,C,D) shall be located carefully so that products are not subjected to the mechanical stress due to warping the board. Because they may be subjected to the mechanical stress in order of $A > C > B \cong D$.

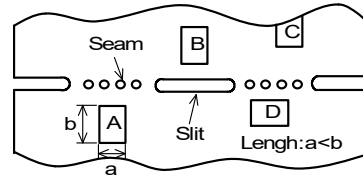

13.4. Attention Regarding P.C.B. Design

< The Arrangement of Products >

P.C.B. shall be designed so that products are far from the portion of perforation.

The portion of perforation shall be designed as narrow as possible, and shall be designed so as not to be applied the stress in the case of P.C.B. separation.

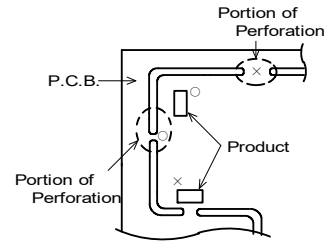

Products shall not be arranged on the line of a series of holes when there are big holes in P.C.B. (Because the stress concentrate on the line of holes.)

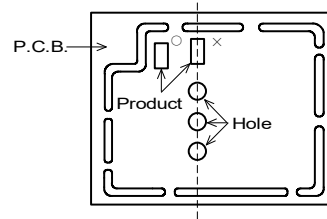

< Products Placing >

Support pins shall be set under P.C.B. to prevent causing a warp to P.C.B. during placing the products on the other side of P.C.B.

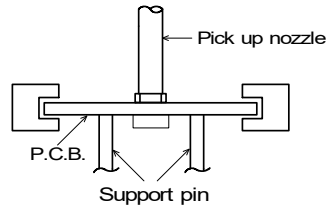

< P.C.B. Separation >

P.C.B. shall not be separated with hand. P.C.B. shall be separated with the fixture so as not to cause P.C.B. bending.

13.5. Standard Land Dimensions

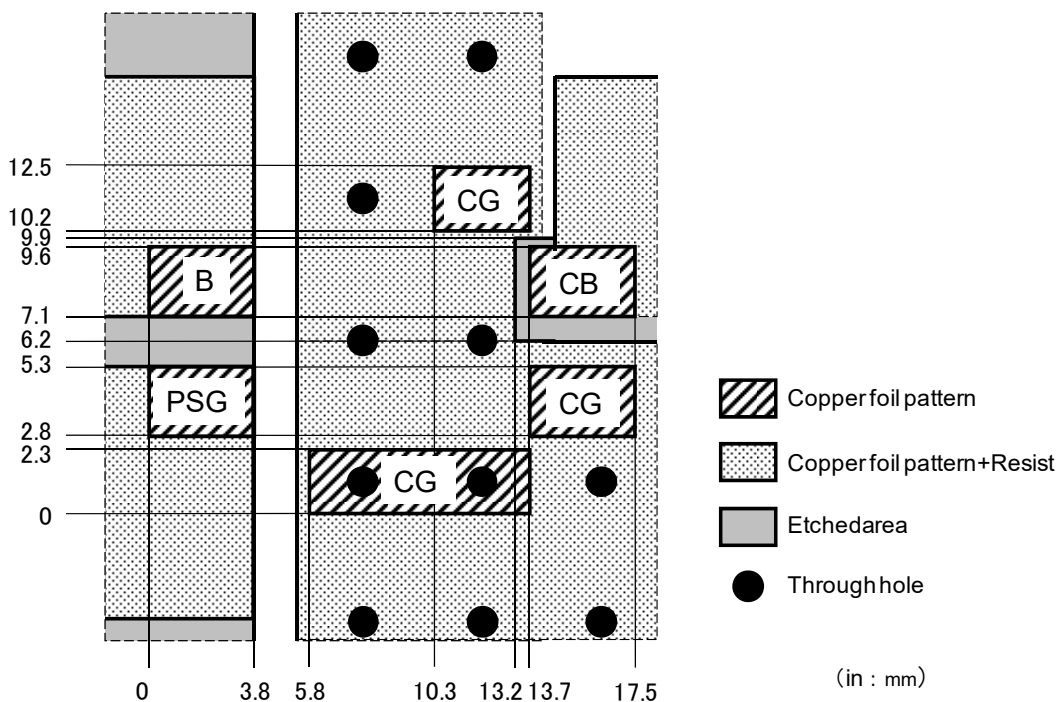

- (1) Design the land pads for this part as shown above on both side printed circuit board (or a multiple layered substrate).
- (2) This product is designed to meet large current.
Please design PCB pattern which is connected to this product not to become too hot by applied large current.
- (3) Ground area of CG should be connected to ground layer on the other side (or ground layer of multiple layered substrate) with through holes as shown above.
It is recommended to take the ground area as wide as possible.
- (4) It is recommended to use the connection to the ground layer with through holes and the ground layer to be circuit board wide.
- (5) Even in case that it isn't possible to use a both side printed circuit board (or a multiple layered substrate), the land pads for CG should be designed as wide as possible.

13.6. Reflow Soldering

- (1) Solder paste printing for reflow soldering
 - Standard thickness of solder paste should be 150 to 200 μm .
Incidentally, depending on the reflow condition and the way of heat conduction, the solder would not wet up the terminal, being possible to lead to not enough connection between terminals and lands on the circuit board / open circuit in the circuit board. In case of use, always evaluate this part in your products with actual use condition.
 - For the solder paste printing pattern, use standard land dimensions.
 - For the resist and copper foil pattern, use standard land dimensions.
 - Use Sn / Pn = 60 / 40 or Sn-3.0Ag-0.5Cu solder

(2) Soldering Conditions

Standard soldering profile and the limit soldering profile is as follows.

The excessive soldering conditions may cause leaching of the electrode and/or resulting in the deterioration of product quality.

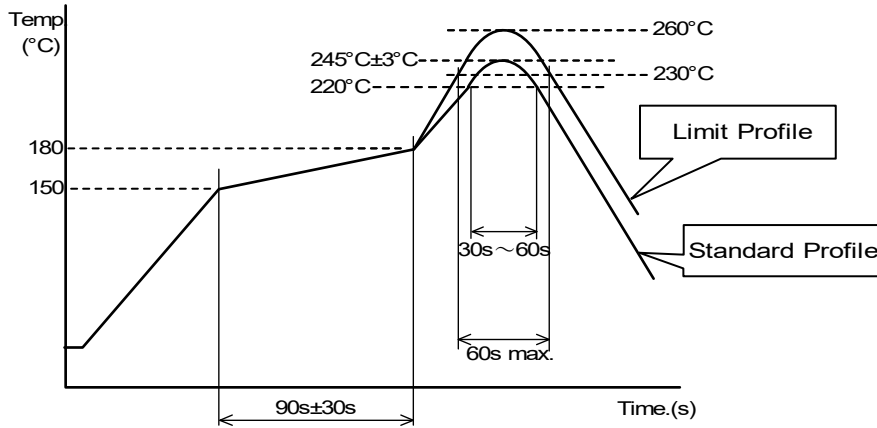

	Standard Profile	Limit Profile
Pre-heating	150°C ~ 180°C , 90s ± 30s	
Heating	above 220°C , 30s ~ 60s	above 230°C , 60s max.
Peak temperature	245°C ± 3°C	260°C , 10s
Cycle of reflow	2 times	2 times

13.7. Reworking with Soldering iron

· The following conditions shall be strictly followed when using a soldering iron.

Pre-heating	150°C, 1 min
Tip temperature	450°C max.
Soldering iron output	100W max.
Soldering time	5s
Time	2 times

Note : Do not touch the products directly with the tip of the soldering iron.

13.8. Cleaning Conditions

Don't cleaning product due to non-waterproof construction.

13.9. Operating Environment

Do not use this product under the following environmental conditions, on deterioration of the performance, such as insulation resistance may result from the use.

- (1) in the corrodible atmosphere (acidic gases, alkaline gases, chlorine, sulfur gases, organic gases and etc.)
- (2) in the atmosphere where liquid such as organic solvent, may splash on the products.

13.10. Handling of a substrate

After mounting products on a substrate, do not apply any stress to the product caused by bending or twisting to the substrate when cropping the substrate, inserting and removing a connector from the substrate or tightening screw to the substrate.

Excessive mechanical stress may cause cracking in the product.

Bending

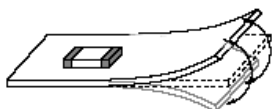

Twisting

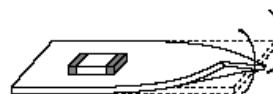

13.11 Storage condition

(1) Storage period

Use the products within 12 months after delivered.

Solderability should be checked if this period is exceeded.

(2) Storage environment condition

· Products should be stored in the warehouse on the following conditions.

Temperature : - 10 °C to + 40 °C

Humidity : 15 % to 85% relative humidity No rapid change on temperature and humidity

· Don't keep products in corrosive gases such as sulfur, chlorine gas or acid, or it may cause oxidization of electrode, resulting in poor solderability.

· Products should be stored on the palette for the prevention of the influence from humidity, dust and so on.

· Products should be stored in the warehouse without heat shock, vibration, direct sunlight and so on.

· Products should be stored under the airtight packaged condition.

(3) Delivery

Care should be taken when transporting or handling product to avoid excessive vibration or mechanical shock.

14.  Notes

(1) Please make sure that your product has been evaluated in view of your specifications with our product being mounted to your product.

(2) You are requested not to use our product deviating from the reference specifications.

(3) The contents of this reference specification are subject to change without advance notice. Please approve our product specifications or transact the approval sheet for product specifications before ordering.

Данный компонент на территории Российской Федерации

Вы можете приобрести в компании MosChip.

Для оперативного оформления запроса Вам необходимо перейти по данной ссылке:

<http://moschip.ru/get-element>

Вы можете разместить у нас заказ для любого Вашего проекта, будь то серийное производство или разработка единичного прибора.

В нашем ассортименте представлены ведущие мировые производители активных и пассивных электронных компонентов.

Нашей специализацией является поставка электронной компонентной базы двойного назначения, продукции таких производителей как XILINX, Intel (ex.ALTERA), Vicor, Microchip, Texas Instruments, Analog Devices, Mini-Circuits, Amphenol, Glenair.

Сотрудничество с глобальными дистрибьюторами электронных компонентов, предоставляет возможность заказывать и получать с международных складов практически любой перечень компонентов в оптимальные для Вас сроки.

На всех этапах разработки и производства наши партнеры могут получить квалифицированную поддержку опытных инженеров.

Система менеджмента качества компании отвечает требованиям в соответствии с ГОСТ Р ИСО 9001, ГОСТ РВ 0015-002 и ЭС РД 009

Офис по работе с юридическими лицами:

105318, г.Москва, ул.Щербаковская д.3, офис 1107, 1118, ДЦ «Щербаковский»

Телефон: +7 495 668-12-70 (многоканальный)

Факс: +7 495 668-12-70 (доб.304)

E-mail: info@moschip.ru

Skype отдела продаж:

moschip.ru

moschip.ru_4

moschip.ru_6

moschip.ru_9