

RK168 Rotary Motor-driven Type

Remote controllable and available in a wide variety of products

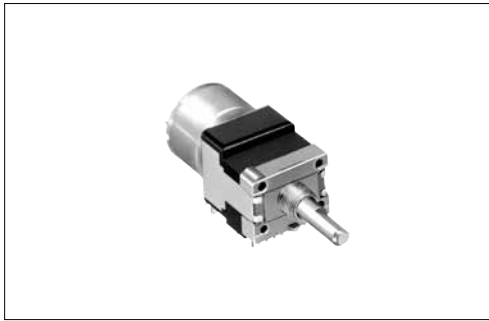

Typical Specifications



| Items | Specifications |
|---|--|
| Total resistance tolerance | ±20% |
| Maximum operating voltage | 50V AC |
| Total rotational angle | 300° ±5° |
| Rotational torque | 10 to 40mN·m |
| Operating life | 15,000 cycles |
| Operating temperature range | -10°C to +70°C |
| Motor voltage | 4 to 6V DC (Standard: 4.5VDC) |
| Potentiometer rotational speed (sec/300°) | 12±3 (4.5V DC) |
| Maximum operating current | At rotation: 100mA / At end slip: 150mA |

Product Line

| Number of resistor elements | Mounting direction | Shaft type | Length of the shaft L ₁ (mm) | Total resistance (kΩ) | Resistance taper | Motor print terminal | Minimum order unit (pcs.) | | Products No. | Drawing No. |
|-----------------------------|--------------------|------------|---|-----------------------|------------------|----------------------|---------------------------|--------|---------------------|-------------|
| | | | | | | | Japan | Export | | |
| Dual-unit | Horizontal type | Flat | 25 | 100 | 3B | With | 200 | 200 | RK16812MG099 | 1 |
| | | | | 10 | | Without | | | RK16812MG09T | 2 |
| Quad-unit | | | | 100 | 15A | | | | RK16814MGA0K | 3 |

Note

Other varieties are also available. Refer to "Other Specifications" (P.340, 341).

Packing Specifications

Tray

| Number of packages (pcs.) | | Export package measurements (mm) |
|---------------------------|------------------------|----------------------------------|
| 1 case /Japan | 1 case /export packing | |
| 200 | 200 | 527×368×215 |

Dimensions

Unit:mm

| No. | Photo | Style | PC board mounting hole dimensions (Viewed from mounting side) |
|-----|---|---|---|
| 1 | <p>16mm size Single-shaft, dual-unit RK16812MG</p> | <p>Shaft shown in full CCW position</p> | |
| 2 | <p>16mm size Single-shaft, dual-unit RK16812MG</p> | <p>Shaft shown in full CCW position</p> | |

Refer to P.340 for other specifications.
 Refer to P.341 for attached parts.
 Refer to P.342 for ordering products not listed.
 Refer to P.343 for soldering conditions.

Rotary Potentiometers
 Slide Potentiometers
 Metal Shaft
 Insulated Shaft
 Knob Operating
 Through Shaft Type
 Ring Type

RK168 Rotary Motor-driven Type

Dimensions

Unit:mm

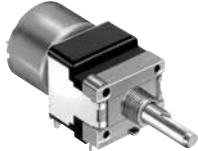
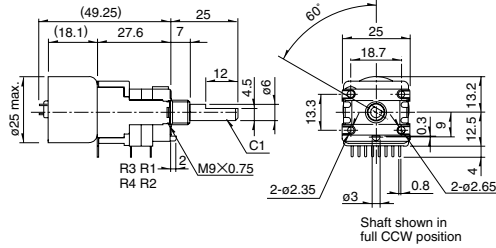
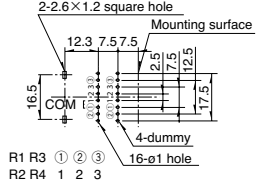
| No. | Photo | Style | PC board mounting hole dimensions (Viewed from mounting side) |
|-----|--|--|--|
| 3 |  <p>16mm size Single-shaft, quad.-unit RK16814MG</p> |  <p>Shaft shown in full CCW position</p> |  <p>2-2.6×1.2 square hole Mounting surface COM R1 R3 ① ② ③ R2 R4 1 2 3 4-dummy 16-φ1 hole</p> |

Terminal Layout / Circuit Diagram

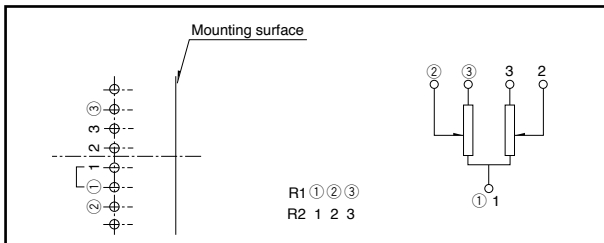

Rotary Motor-driven Type / Other Specifications

In addition to the products listed, we can accommodate the follow specifications.

Basic Motor Specifications

| Number of unit | Model | Motor type | | Motor voltage | Potentiometer rotational speed | Max. operating current |
|-------------------------|-----------|-------------|------------------------|-------------------------------|--------------------------------|---|
| | | Sealed case | Motor printed terminal | | | |
| Single-shaft, dual-unit | RK16812MG | Available | Available | 4 to 6V DC (Standard: 4.5) | 12±3sec./300° (4.5V DC) | At rotation 100mA At end slip 150mA (4.5V DC) |
| Single-shaft, quad-unit | RK16814MG | | | | | |

Total Resistance Variety

| Total resistance (kΩ) | 10 | 20 | 50 | 100 |
|-----------------------|----|----|----|-----|
| | | | | |

Resistance Taper

| Resistance taper | 15A | 3B |
|------------------|-----|----|
| | | |

Rotary Motor-driven Type / Other Specifications

Shaft Variety

Unit:mm

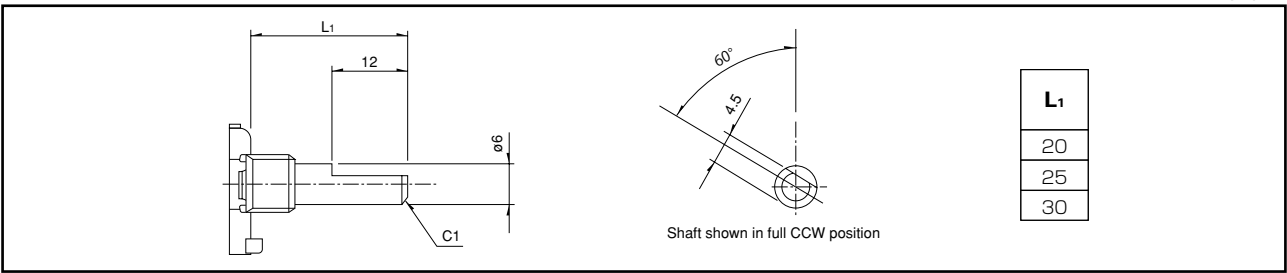

Standard Dimensions of Bushing and Fixing Lug

Unit:mm

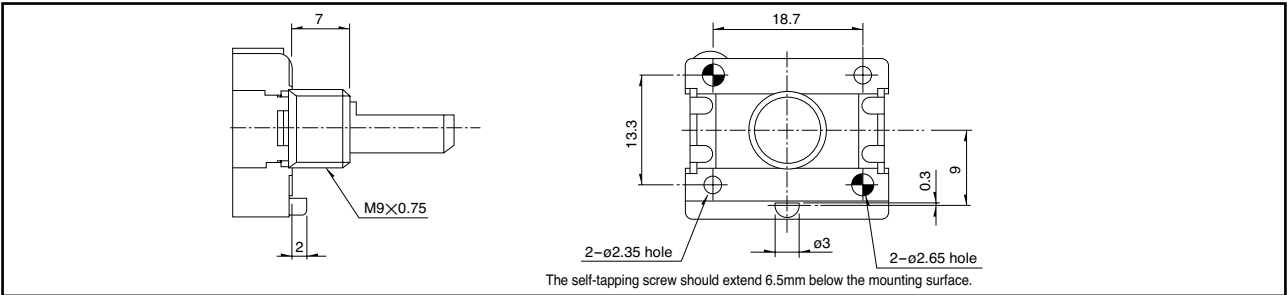

Style of Printed Terminal for Motor

Unit:mm

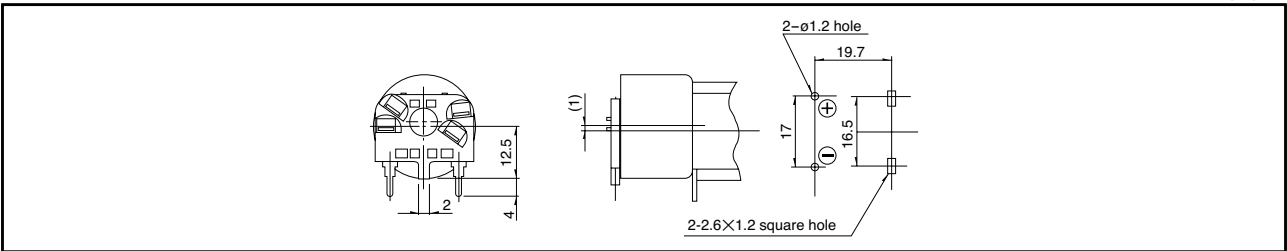

Note

Marked are specifications recommended by Alps Alpine.

Rotary Motor-driven Type / Attached Parts

The following parts are included with the product.

Unit:mm

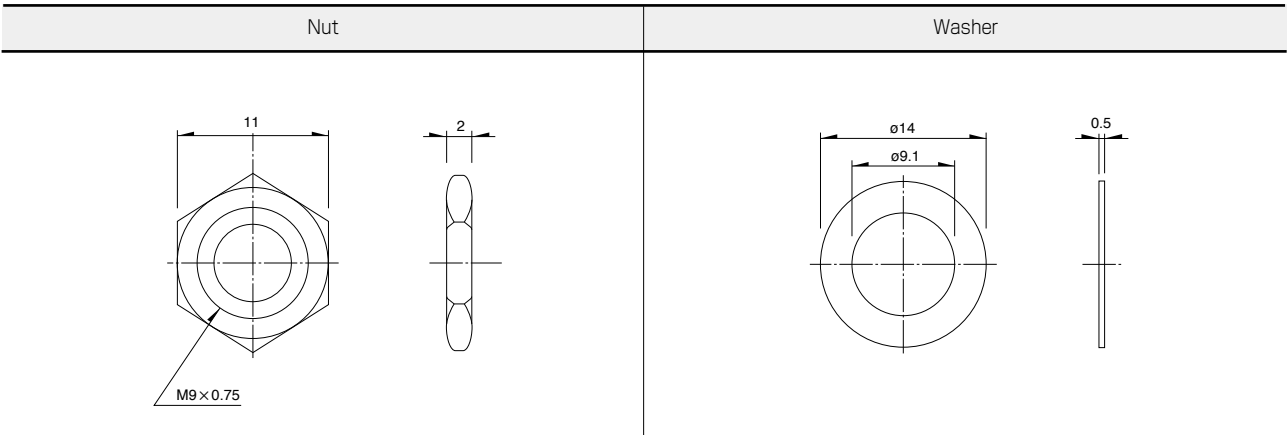

Rotary Motor-driven Type / Ordering Products Not Listed

When ordering product varieties that are not listed, specify referring to the examples below.

Sample Part Number

R K 1 6 8 1 2 M G - **F 2 0** - **B 1 0 3** - **M 0**

Model type

| Code | Model type |
|------|-------------------------|
| 12 | Single-shaft, dual-unit |
| 14 | Single-shaft, quad-unit |

Shaft type

| Code | Shaft type |
|------|------------|
| F | Flat |

※ Flat shaft only

Length of the shaft L₁ (mm)

| Code | Length of the shaft |
|------|---------------------|
| 20 | 20 |
| 25 | 25 |
| 30 | 30 |

Resistance taper

| Code | Resistance taper |
|------|------------------|
| A | 15A |
| V | 3B |

※ 1B can be accommodated on request. Please inquire.

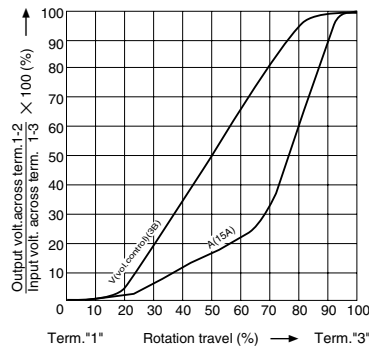

Total resistance

| Code | Total resistance (k Ω) |
|------|------------------------|
| 10 | 103 |
| 20 | 203 |
| 50 | 503 |
| 100 | 104 |











Printed terminal for motor

| Code | Printed terminal for motor |
|------|----------------------------|
| M0 | without |
| M1 | with |

Note

Marked are specifications recommended by Alps Alpine.

Rotary Potentiometers
Slide Potentiometers
Metal Shaft
Insulated Shaft
Knob Operating
Through Shaft Type
Ring Type

| Type | 16mm size | 20mm size | 27mm size | 50mm size | Rotary motor-driven | |
|------------------------------|---|--|---|--|---|---|
| Series | RK163 | RK203 | RK271 | RK501 | RK168 | |
| | Single-shaft | | | | | |
| Number of resistor elements | Single/dual | Single | Single/dual/quad | Dual/quad | Dual/quad/5-ganged/6-ganged | |
| Photo |  |  |  |  |  | |
| Terminal mounting | Horizontal | Vertical | Horizontal | | | |
| Fixing method of bushing | Bushing screw clamp | | | | | |
| Operating temperature range | -10°C to +70°C | -40°C to +85°C | -10°C to +70°C | | | |
| Operating life | 15,000 cycles | 30,000 cycles | 15,000 cycles | | | |
| Available for automotive use | — | ○ | — | — | — | |
| Life cycle (availability) |  |  |  |  |  | |
| Electrical performance | Total resistance (kΩ) | 5, 10, 20, 50, 100, 200 | 10 | 5, 10, 20, 50, 100, 250 | 10, 20, 50, 100 | |
| | Resistance taper | 15A, 1B, 3B, 15C | B | 15A, 3B | | |
| | Rated Power | 0.1W 0.05W (15A) | 0.05W | | 0.1W | 0.05W |
| | Residual resistance | R≤10kΩ 20Ω max. 10kΩ<R≤50kΩ 30Ω max. 50kΩ<R<3MΩ Nominal total resistance of 0.1% or less% | — | R≤10kΩ 20Ω max. 10kΩ<R<50kΩ 30Ω max. 50kΩ≤R Nominal total resistance of 0.1% or less% | — | — |
| | Maximum attenuation (Volume control) | 5kΩ≤R<10kΩ 70dB min. 10kΩ≤R<50kΩ 80dB min. 50kΩ≤R<100kΩ 90dB min. 100kΩ≤R 100dB min. | — | 5kΩ≤R<10kΩ 70dB min. 10kΩ≤R<50kΩ 80dB min. 50kΩ≤R<100kΩ 90dB min. 100kΩ≤R 100dB min. | 120dB min. | 5kΩ≤R<10kΩ 70dB min. 10kΩ≤R<50kΩ 80dB min. 50kΩ≤R<100kΩ 90dB min. 100kΩ≤R 100dB min. |
| | Gang error applicable to Dual-unit parts for audio volume control purposes | -40dB to 0dB 3dB max. | — | -70dB to -60dB 3dB max. -60dB to 0dB 2dB max. | -100dB to 0dB 2dB max. | -60dB to -40dB 5dB max. -40dB to 0dB 3dB max. |
| | Insulation resistance | 100MΩ min. 500V DC | 10MΩ min. 250V DC | 100MΩ min. 500V DC | | 100MΩ min. 250V DC |
| | Voltage proof | 500V AC for 1minute | 300V AC for 1minute | 500V AC for 1minute | | 300V AC for 1minute |
| | Center-taps | Without | | | | |
| Mechanical performance | Detent | Without, Cente | 17 | Without, Center, 21, 31, 41 | Without | |
| | Stopper strength | 0.9 N·m | 0.5 N·m | 0.9 N·m | 1.5 N·m | 0.9 N·m |
| | Push-pull strength | 100N max. | | 150N max. | 100N max. | |
| | Vibration | 10 to 55 to 10Hz/min., the amplitude is 1.5mm for all the frequencies, in the 3 direction of X, Y and Z for 2 hours respectively | | | | |
| Shaft style | Serrated type, Flat type, Slotted type | Flat type | Slotted type, Flat type | Slotted type | Flat type | |
| Terminal style | Insertion, Lead | Insertion | | | | |
| Attached switch | — | — | — | — | — | |
| Page | 325 | 330 | 333 | 337 | 339 | |

| | |
|---|-----|
| Metal Shaft Potentiometers Soldering Conditions | 343 |
| Potentiometers Cautions | 418 |
| Potentiometers Measurement and Test Methods | 420 |
| Potentiometers Resistance Taper | 422 |

Note

○ Indicates applicability to some products in the series.

Reference for Manual Soldering

| Series | Tip temperature | Soldering time | No. of solders |
|---------------------|-------------------------------|--------------------------------|----------------|
| RK09L, RK097 | 350°C max. | 3s max. | 1 time |
| RK203 | 300°C max. | 3s max. | 1 time |
| RK119 | 350±10°C | 3 ⁺¹ ₀ s | 1 time |
| RK271 | 350°C max. | 5s max. | 1 time |
| RK501 | 350±10°C | 5 ⁺¹ ₀ s | 1 time |
| RK163 | 350°C max. | 5s max. | 1 time |
| RK168 | Potentiometer terminal | 300°C max. | 3s max. |
| | Motor terminal | 350°C max. | 2s max. |

Reference for Dip Soldering

| Series | Preheating | | Dip soldering | | No. of solders |
|----------------------------|-------------------------------|--------------|-----------------------|----------------|----------------|
| | Soldering surface temperature | Heating time | Soldering temperature | Soldering time | |
| RK09L, RK097, RK203 | 100°C max. | 2 min. max. | 260±5°C | 5±1s | 2 time max. |
| RK501 | 120±10°C | 2 min. max. | 260±5°C | 5±1s | 2 time |

Example of Reflow Soldering Condition

Temperature profile

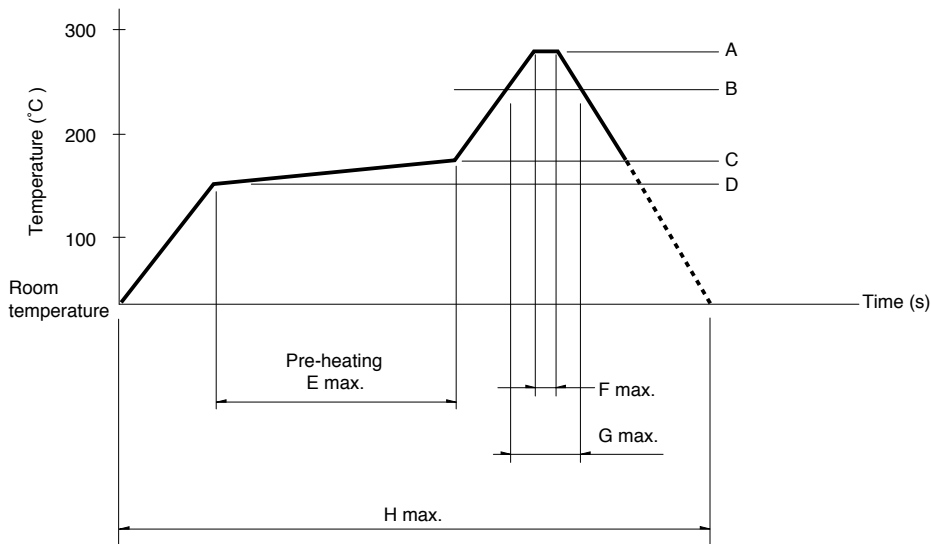

| Series | A | B | C | D | E | F | G | H | No. of reflows |
|--------------|-------|-------|-------|-------|--------|----|-----|--------|----------------|
| RK119 | 260°C | 230°C | 180°C | 150°C | 2 min. | 3s | 40s | 4 min. | 2 time max. |

Notes

1. When using an infrared reflow oven, solder may sometimes not be applied. Be sure to use a hot air reflow oven or at type that uses infrared rays in combination with hot air.
2. The temperatures given above are the maximum temperatures at the terminals of the potentiometer when employing a hot air reflow method. The temperature of the PC board and the surface temperature of the potentiometer may vary greatly depending on the PC board material, its size and thickness. Ensure that the surface temperature of the potentiometer does not rise to 250°C or greater.
3. Conditions vary to some extent depending on the type of reflow bath used. Be sure to give due consideration to this prior to use.

Данный компонент на территории Российской Федерации

Вы можете приобрести в компании MosChip.

Для оперативного оформления запроса Вам необходимо перейти по данной ссылке:

<http://moschip.ru/get-element>

Вы можете разместить у нас заказ для любого Вашего проекта, будь то серийное производство или разработка единичного прибора.

В нашем ассортименте представлены ведущие мировые производители активных и пассивных электронных компонентов.

Нашей специализацией является поставка электронной компонентной базы двойного назначения, продукции таких производителей как XILINX, Intel (ex.ALTERA), Vicor, Microchip, Texas Instruments, Analog Devices, Mini-Circuits, Amphenol, Glenair.

Сотрудничество с глобальными дистрибьюторами электронных компонентов, предоставляет возможность заказывать и получать с международных складов практически любой перечень компонентов в оптимальные для Вас сроки.

На всех этапах разработки и производства наши партнеры могут получить квалифицированную поддержку опытных инженеров.

Система менеджмента качества компании отвечает требованиям в соответствии с ГОСТ Р ИСО 9001, ГОСТ РВ 0015-002 и ЭС РД 009

Офис по работе с юридическими лицами:

105318, г.Москва, ул.Щербаковская д.3, офис 1107, 1118, ДЦ «Щербаковский»

Телефон: +7 495 668-12-70 (многоканальный)

Факс: +7 495 668-12-70 (доб.304)

E-mail: info@moschip.ru

Skype отдела продаж:

moschip.ru

moschip.ru_4

moschip.ru_6

moschip.ru_9