

LE CG P2A

OSRAM OSTAR® Projection Power

OSRAM OSTAR Projection Power is a high luminance LED for projection applications.

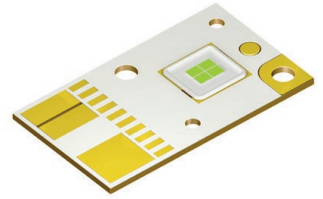

Applications

- Projection Home LED & Laser
- Projection Professional LED & Laser

Features:

- Package: OSTAR High Power Projection
- Chip technology: UX:3
- Typ. Radiation: 120° (Lambertian emitter)
- Color: Cx = 0.318, Cy = 0.642 acc. to CIE 1931 (● converted green)
- Corrosion Robustness Class: 3B
- ESD: 2 kV acc. to ANSI/ESDA/JEDEC JS-001 (HBM, Class 2)

Ordering Information

Type	Luminous Flux ¹⁾ I _F = 24000 mA Φ _V	Ordering Code
LE CG P2A-7U7V-A	5600 ... 10000 lm	Q65112A3031

Maximum Ratings

Parameter	Symbol		Values
Operating Temperature	T_{op}	min.	-40 °C
		max.	125 °C
Storage Temperature	T_{stg}	min.	-40 °C
		max.	125 °C
Junction Temperature	T_j	max.	150 °C
Forward Current $T_j = 150$ °C; all chips operated in parallel	I_F	min.	400 mA
		max.	20000 mA
Forward Current pulsed $D = 0.5$; $T_B = 25$ °C; all chips operated in parallel	$I_{F\ pulse}$		32000 mA
Surge Current $t_p \leq 10$ μ s; $D = 0.1$; $T_j = 150$ °C; all chips operated in parallel	I_{FS}	max.	40000 mA
ESD withstand voltage acc. to ANSI/ESDA/JEDEC JS-001 (HBM, Class 2)	V_{ESD}		2 kV
Reverse current ²⁾	I_R	max.	200 mA

Characteristics

$T_{\text{Board}} = 25\text{ °C}$; $I_{\text{F}} = 24000\text{ mA}$; $f = 1000\text{ Hz}$; $t_{\text{int}} = 100\text{ ms}$; $D = 0.5$; all chips operated in parallel

Parameter	Symbol		Values
Chromaticity Coordinate ³⁾ within $\lambda = 500 \dots 600\text{ nm}$	C_x	typ.	0.318
	C_y	typ.	0.642
Peak Wavelength	λ_{peak}	typ.	520 nm
Spectral bandwidth at 50% $I_{\text{rel,max}}$	$\Delta\lambda$	typ.	100 nm
Viewing angle at 50% I_{V}	2ϕ	typ.	120 °
Radiating surface	A_{color}	typ.	2.6 x 3.2 mm ²
Partial Flux acc. CIE 127:2007 ⁴⁾ $I_{\text{F}} = 24000\text{ mA}$	$\Phi_{\text{E/V, 120°}}$	typ.	0.77
Forward Voltage ⁵⁾ $I_{\text{F}} = 24000\text{ mA}$; all chips operated in parallel	V_{F}	min.	3.20 V
		typ.	3.35 V
		max.	4.30 V
Deviation of forward voltage of all chips	V_{F}	max.	135 mV
Reverse voltage (ESD device)	$V_{\text{R ESD}}$	min.	45 V
Reverse voltage ²⁾ $I_{\text{R}} = 20\text{ mA}$	V_{R}	max.	1.2 V
Real thermal resistance junction/board	$R_{\text{thJB real}}$	typ.	0.7 K / W
Electrical thermal resistance junction/board with efficiency $\eta_{\text{e}} = 18\%$	$R_{\text{thJB elec.}}$	typ.	0.57 K / W

Brightness Groups

Group	Luminous Flux ¹⁾ $I_{\text{F}} = 24000\text{ mA}$ min.	Luminous Flux ¹⁾ $I_{\text{F}} = 24000\text{ mA}$ max.
	Φ_{V}	Φ_{V}
7U	5600 lm	6300 lm
8U	6300 lm	7100 lm
5V	7100 lm	8000 lm
6V	8000 lm	9000 lm
7V	9000 lm	10000 lm

Chromaticity Coordinate Groups

within $\lambda = 500 \dots 600 \text{ nm}$

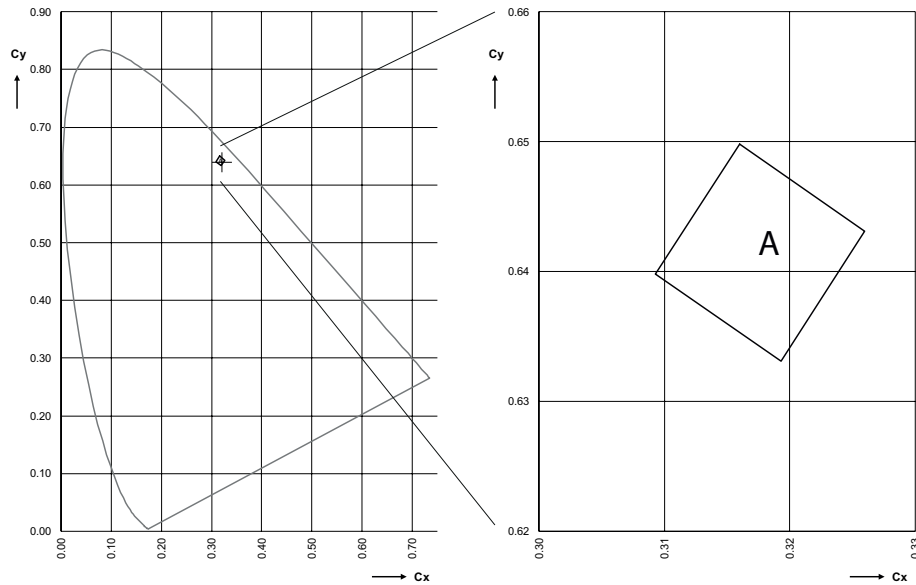

Chromaticity Coordinate Groups ³⁾

Group	Cx	Cy
A	0.3093	0.6398
	0.3160	0.6498
	0.3260	0.6431
	0.3193	0.6331

Group Name on Label

Example: 5V-A

Brightness

Color Chromaticity

5V

A

Relative Spectral Emission ⁴⁾

$\Phi_{rel} = f(\lambda)$; $I_F = 24000 \text{ mA}$; $T_J = 25 \text{ }^\circ\text{C}$; all chips operated in parallel

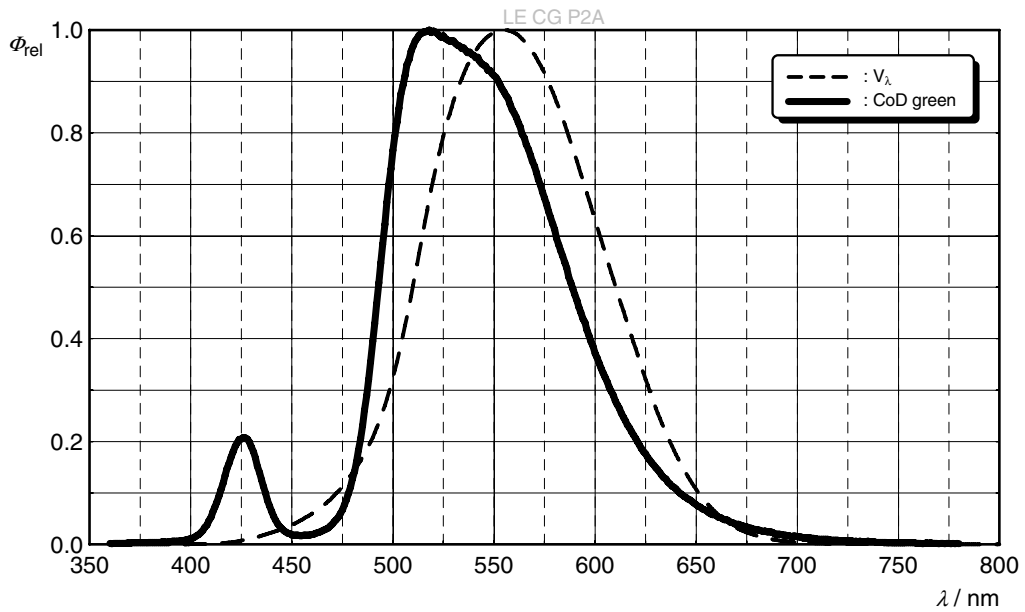

Radiation Characteristics ⁴⁾

$I_{rel} = f(\phi)$; $T_J = 25 \text{ }^\circ\text{C}$

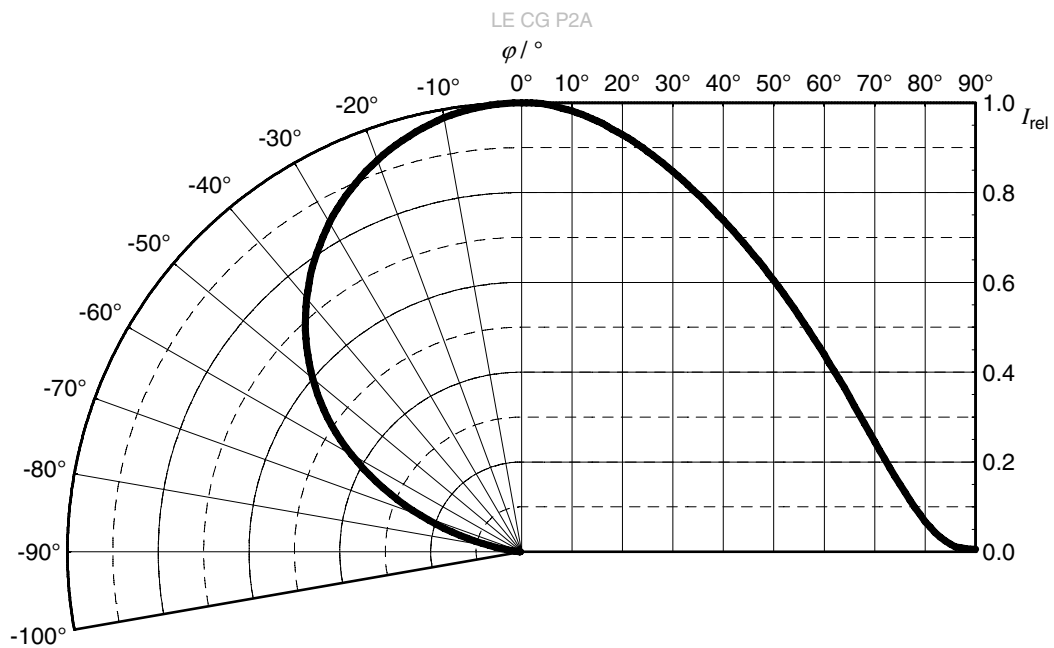

Not for new design

Relative Partial Flux ⁴⁾

$$\Phi_v(2\varphi)/\Phi_v(180^\circ) = f(\varphi); T_j = 25^\circ\text{C}$$

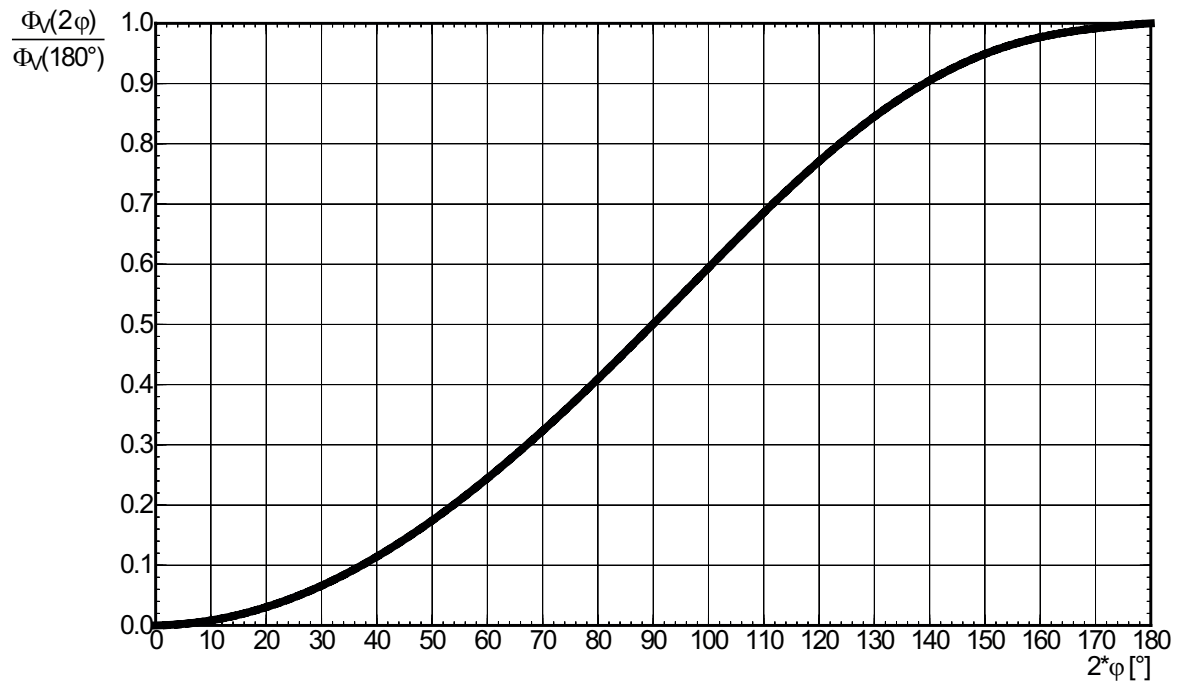

Relative cumulated Luminous Flux ⁴⁾

$$\Phi_{Vrel-cum} = f(\lambda); I_F = 24000\text{ mA}; T_j = 25^\circ\text{C}; \text{all chips operated in parallel}$$

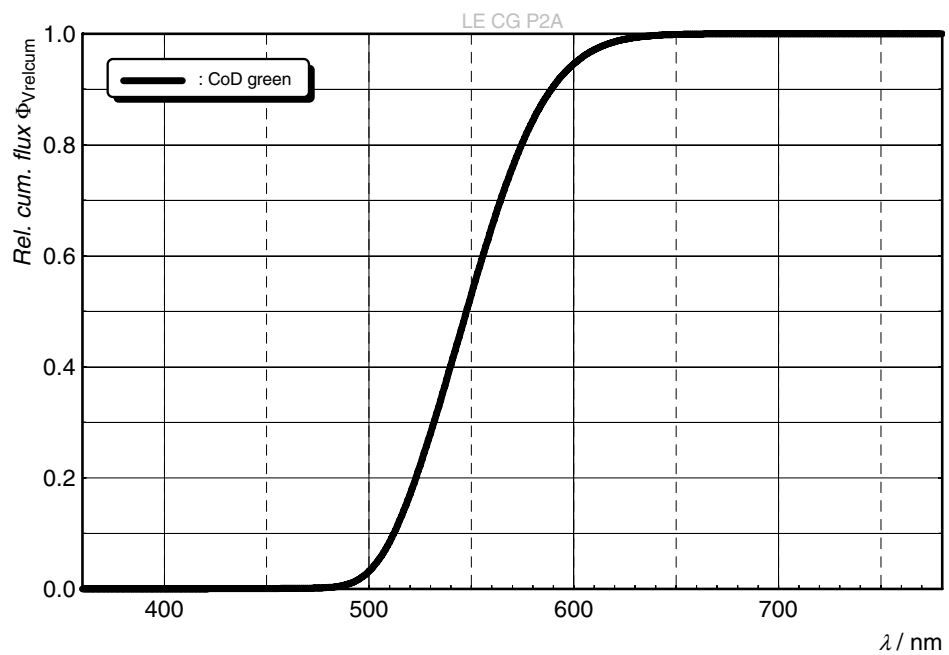

Not for new design

Forward current ^{4), 6)}

$I_F = f(V_F)$; $T_J = 25\text{ °C}$;
all chips operated in parallel

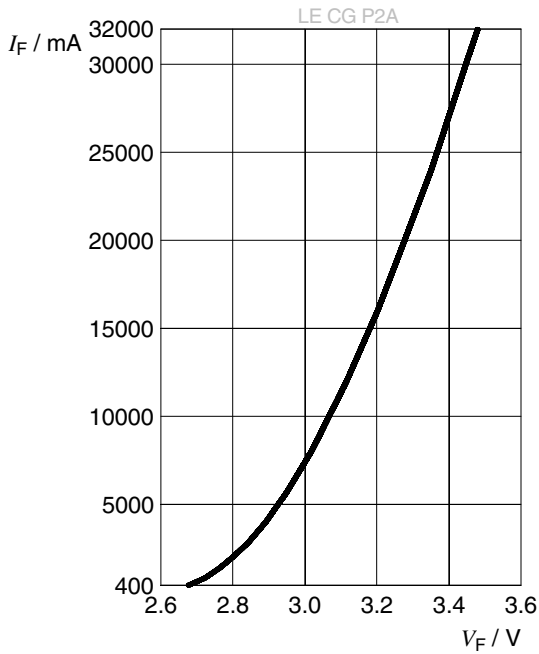

Relative Luminous Flux ^{4), 6)}

$\Phi_V / \Phi_V(24000\text{ mA}) = f(I_F)$; $T_J = 25\text{ °C}$;
all chips operated in parallel

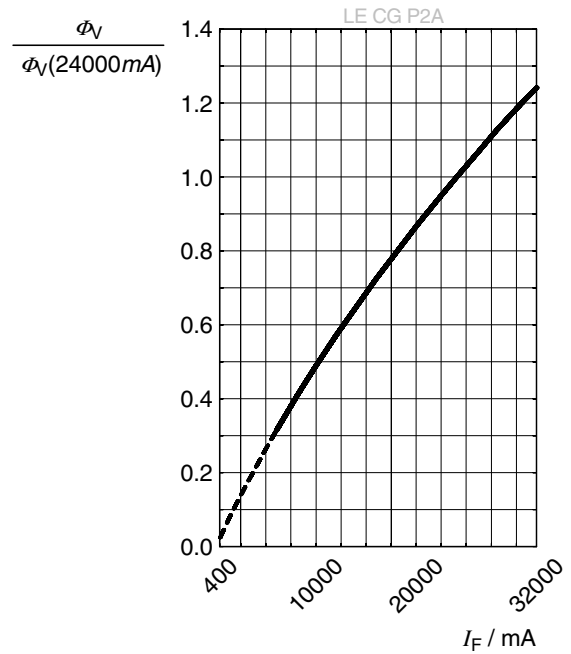

Chromaticity Coordinate Shift ⁴⁾

$\Delta C_x, \Delta C_y = f(I_F)$; $T_J = 25\text{ °C}$; all chips operated in parallel; within $\lambda = 500 \dots 600\text{ nm}$

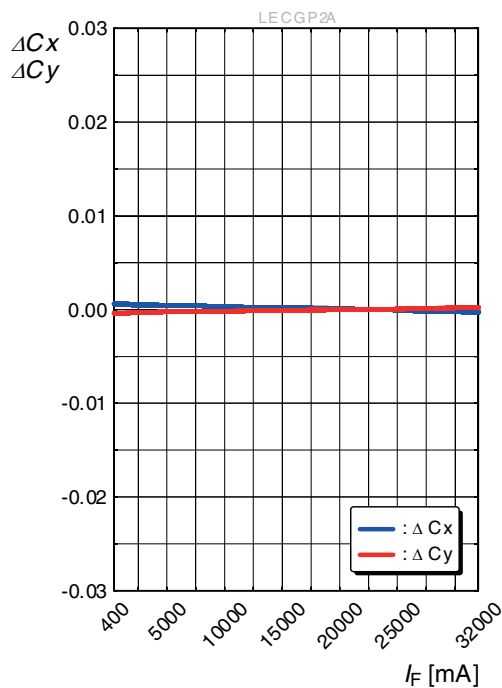

Chromaticity Coordinate Shift ⁴⁾

$\Delta C_x, \Delta C_y = f(I_F)$; $T_J = 25\text{ °C}$; all chips operated in parallel; full spectral range

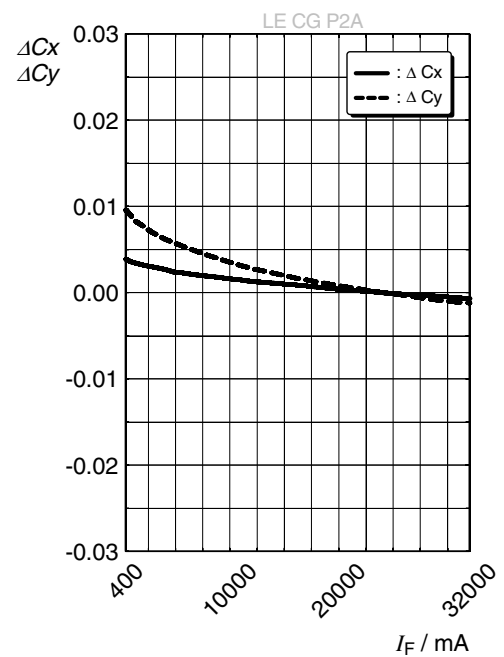

Not for new design

Forward Voltage ⁴⁾

$\Delta V_F = V_F - V_F(25\text{ }^\circ\text{C}) = f(T_j)$; $I_F = 24000\text{ mA}$;
all chips operated in parallel

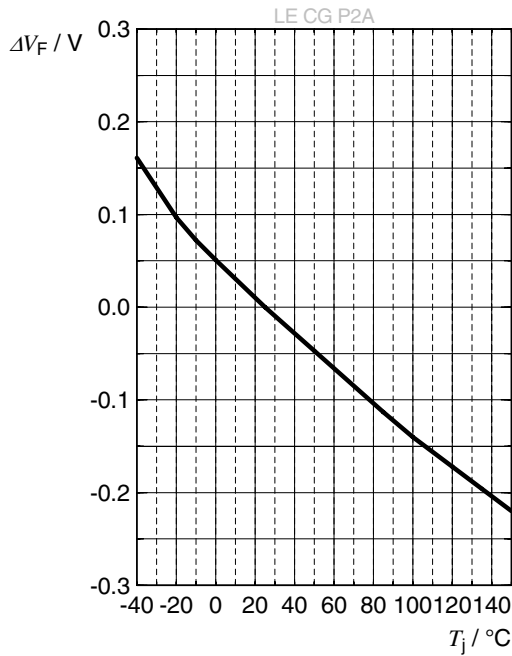

Relative Luminous Flux ⁴⁾

$\Phi_v / \Phi_v(25\text{ }^\circ\text{C}) = f(T_j)$; $I_F = 24000\text{ mA}$;
all chips operated in parallel

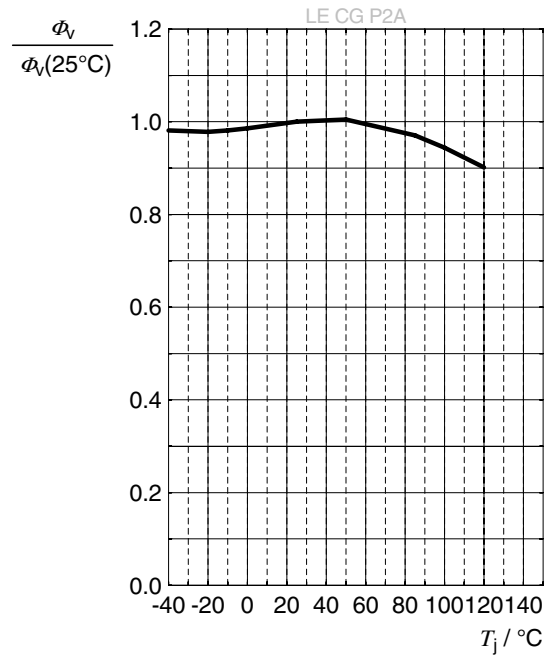

Chromaticity Coordinate Shift ⁴⁾

$\Delta C_x, \Delta C_y = f(T_j)$; $I_F = 24000\text{ mA}$; all chips operated in parallel; within $\lambda = 500 \dots 600\text{ nm}$

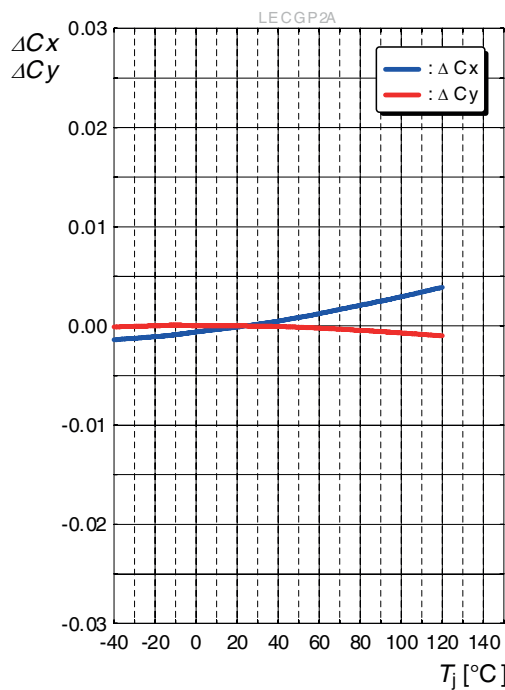

Chromaticity Coordinate Shift ⁴⁾

$\Delta C_x, \Delta C_y = f(T_j)$; $I_F = 24000\text{ mA}$; all chips operated in parallel; full spectral range

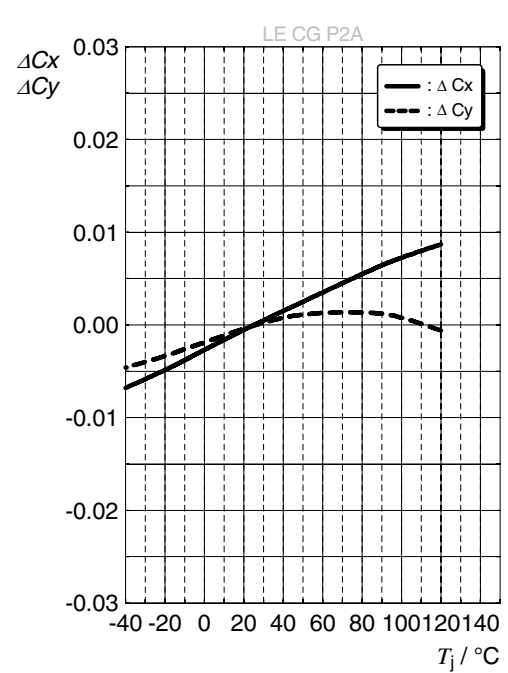

Not for new design

Dimensional Drawing ⁷⁾

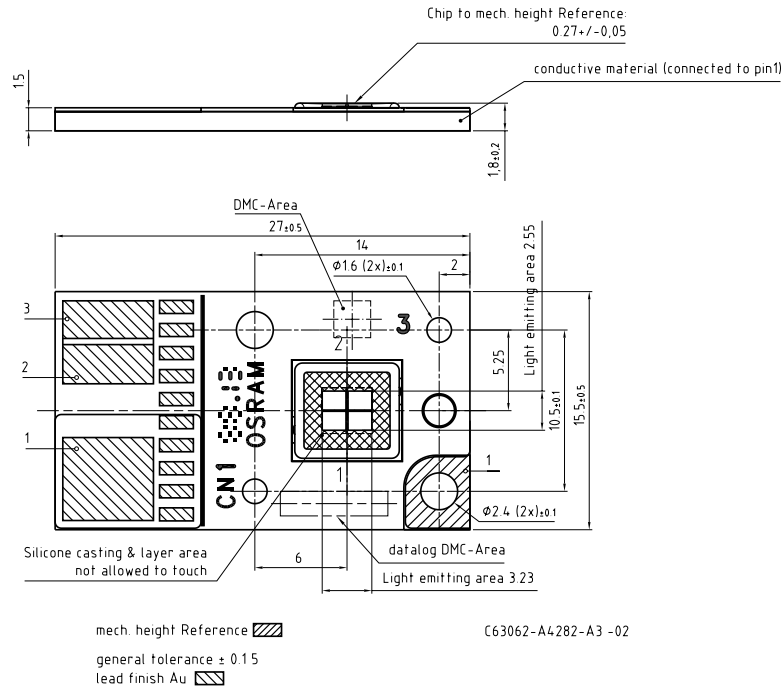

Further Information:

Approximate Weight: 5,000.0 mg

Corrosion test: Class: 3B
Test condition: 40°C / 90 % RH / 15 ppm H₂S / 14 days (stricter than IEC 60068-2-43)

ESD advice: The device is protected by ESD device which is connected in parallel to the Chip.

Notes: Package not suitable for any kind of wet cleaning or ultrasonic cleaning.

Connector: Recommended connector: TARNG YU ENTERPRISE CO.,LTD / TA8051W-NR-02S-A / PO: 4510445465

Electrical Internal Circuit

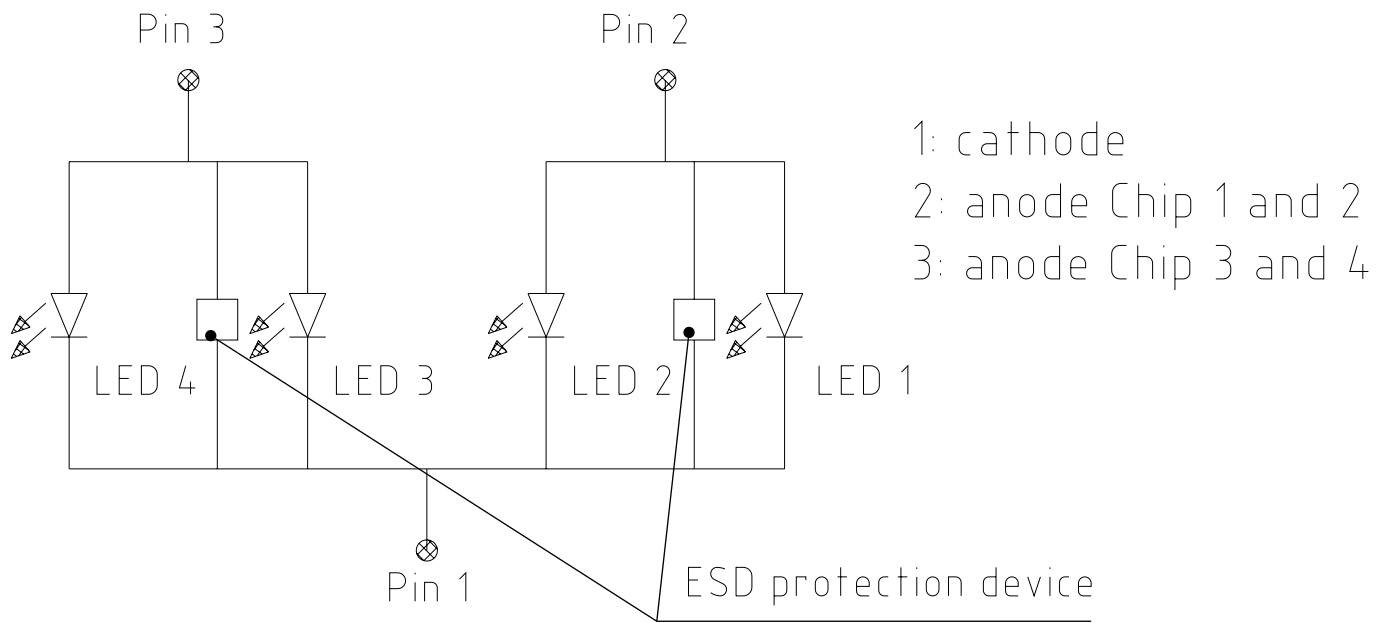

Reflow Soldering Profile

Product complies to MSL Level 2 acc. to JEDEC J-STD-020E

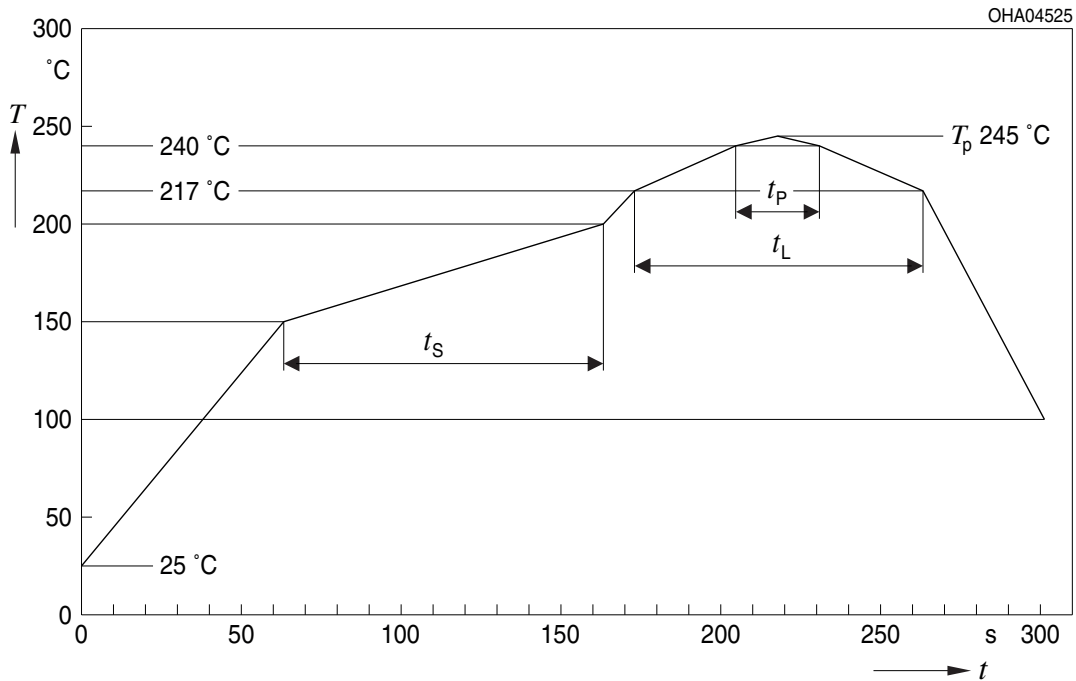

Profile Feature	Symbol	Pb-Free (SnAgCu) Assembly			Unit
		Minimum	Recommendation	Maximum	
Ramp-up rate to preheat ^{*)} 25 °C to 150 °C			2	3	K/s
Time t_s T_{Smin} to T_{Smax}	t_s	60	100	120	s
Ramp-up rate to peak ^{*)} T_{Smax} to T_p			2	3	K/s
Liquidus temperature	T_L		217		°C
Time above liquidus temperature	t_L		80	100	s
Peak temperature	T_p		245	260	°C
Time within 5 °C of the specified peak temperature $T_p - 5$ K	t_p	10	20	30	s
Ramp-down rate* T_p to 100 °C			3	6	K/s
Time 25 °C to T_p				480	s

All temperatures refer to the center of the package, measured on the top of the component
 *) slope calculation DT/Dt : Dt max. 5 s; fulfillment for the whole T-range

Not for new design

Taping ⁷⁾

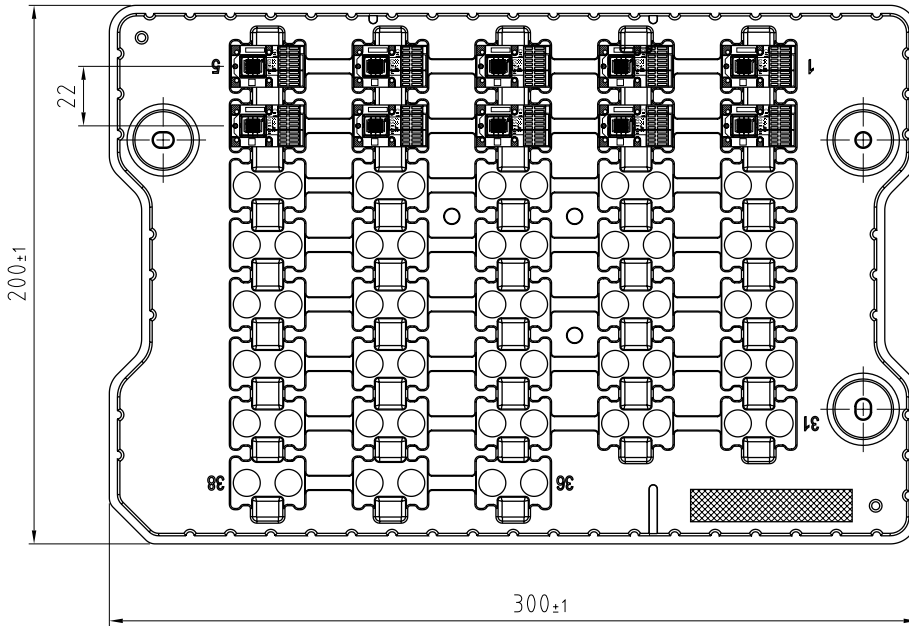

C63062-A4389-B10-01

Barcode-Product-Label (BPL)

OSRAM Opto Semiconductors LX XXXX BIN1: XX-XX-X-XXX-X

RoHS Compliant





(6P) BATCH NO: 1234567890

(1T) LOT NO: 1234567890 (9D) D/C: 1234

(X) PROD NO: 123456789 (Q) QTY: 9999 (G) GROUP: XX-XX-X-X

ML Temp ST
X XXX °C X

Pack: RXX
DEMY XXX
X_X123_1234.1234 X



OHA04563

Barcode-Tray-Label (BTL)

LE xxx xxx Group: xxxx-xxxx-xxxx

Data Matrix Code

xxxx BIN

MATERIAL: Material Number Batch Batch Number BIN: xxxx



OHA02684_1

Schematic Transportation Box ⁷⁾

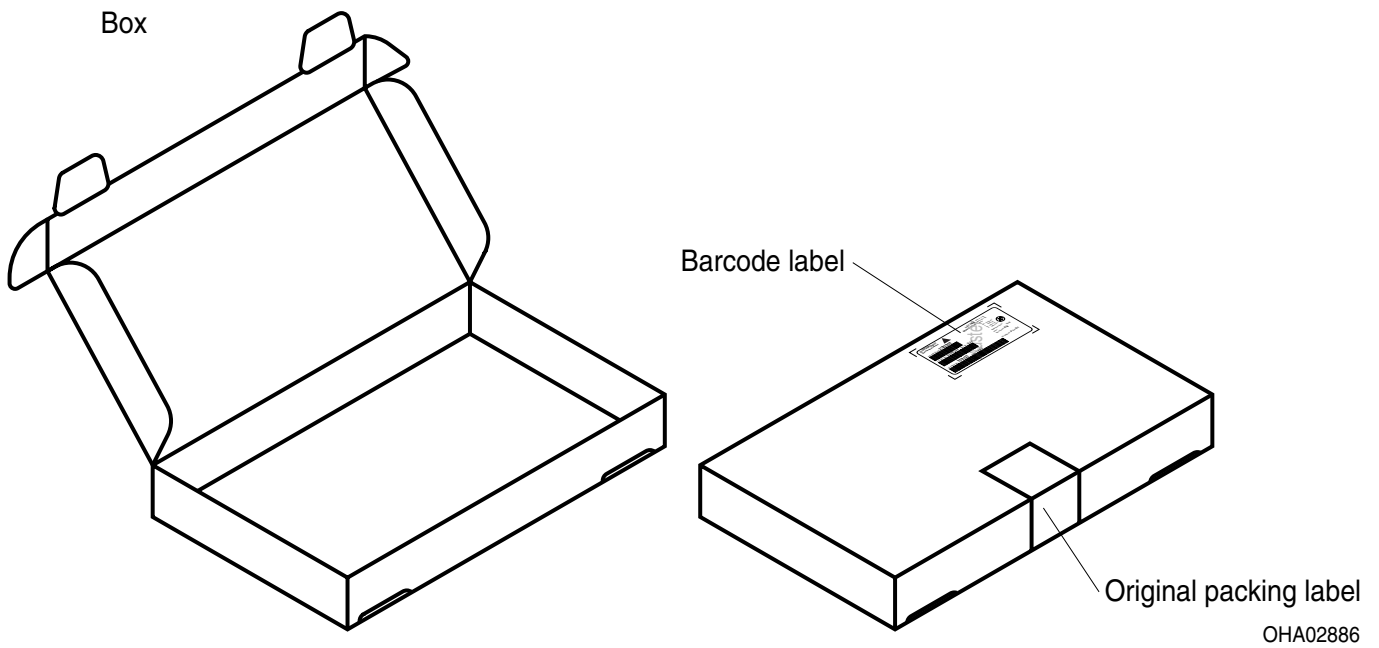

Dimensions of Transportation Box

Width	Length	Height
333 ± 5 mm	218 ± 5 mm	28 ± 5 mm
337 ± 5 mm	218 ± 5 mm	63 ± 5 mm

Type Designation System



Not for new design

Notes

The evaluation of eye safety occurs according to the standard IEC 62471:2006 (photo biological safety of lamps and lamp systems). Within the risk grouping system of this IEC standard, the device specified in this data sheet falls into the class **moderate risk (exposure time 0.25 s)**. Under real circumstances (for exposure time, conditions of the eye pupils, observation distance), it is assumed that no endangerment to the eye exists from these devices. As a matter of principle, however, it should be mentioned that intense light sources have a high secondary exposure potential due to their blinding effect. When looking at bright light sources (e.g. headlights), temporary reduction in visual acuity and afterimages can occur, leading to irritation, annoyance, visual impairment, and even accidents, depending on the situation.

Subcomponents of this device contain, in addition to other substances, metal filled materials including silver. Metal filled materials can be affected by environments that contain traces of aggressive substances. Therefore, we recommend that customers minimize device exposure to aggressive substances during storage, production, and use. Devices that showed visible discoloration when tested using the described tests above did show no performance deviations within failure limits during the stated test duration. Respective failure limits are described in the IEC60810.

For further application related information please visit www.osram-os.com/appnotes

Disclaimer

Attention please!

The information describes the type of component and shall not be considered as assured characteristics. Terms of delivery and rights to change design reserved. Due to technical requirements components may contain dangerous substances.

For information on the types in question please contact our Sales Organization.

If printed or downloaded, please find the latest version on the OSRAM OS website.

Packing

Please use the recycling operators known to you. We can also help you – get in touch with your nearest sales office. By agreement we will take packing material back, if it is sorted. You must bear the costs of transport. For packing material that is returned to us unsorted or which we are not obliged to accept, we shall have to invoice you for any costs incurred.

Product and functional safety devices/applications or medical devices/applications

OSRAM OS components are not developed, constructed or tested for the application as safety relevant component or for the application in medical devices.

OSRAM OS products are not qualified at module and system level for such application.

In case buyer – or customer supplied by buyer – considers using OSRAM OS components in product safety devices/applications or medical devices/applications, buyer and/or customer has to inform the local sales partner of OSRAM OS immediately and OSRAM OS and buyer and /or customer will analyze and coordinate the customer-specific request between OSRAM OS and buyer and/or customer.

Glossary

- 1) **Brightness:** Brightness values are measured during a pulse train of 100 ms with a pulse width of 500 μ s and a frequency of 1 kHz, with an internal reproducibility of \pm 8 % and an expanded uncertainty of \pm 11 % (acc. to GUM with a coverage factor of $k = 3$). The peak brightness is calculated according to the pulse duration and frequency.
- 2) **Reverse Operation:** This product is intended to be operated applying a forward current within the specified range. Applying any continuous reverse bias or forward bias below the voltage range of light emission shall be avoided because it may cause migration which can change the electro-optical characteristics or damage the LED.
- 3) **Chromaticity coordinate groups:** Chromaticity coordinates are measured during a pulse train of 100 ms with a pulse width of 500 μ s and a frequency of 1 kHz, with an internal reproducibility of \pm 0,005 and an expanded uncertainty of \pm 0,01 (acc. to GUM with a coverage factor of $k = 3$).
- 4) **Typical Values:** Due to the special conditions of the manufacturing processes of semiconductor devices, the typical data or calculated correlations of technical parameters can only reflect statistical figures. These do not necessarily correspond to the actual parameters of each single product, which could differ from the typical data and calculated correlations or the typical characteristic line. If requested, e.g. because of technical improvements, these typ. data will be changed without any further notice.
- 5) **Forward Voltage:** The forward voltage is measured during a pulse of typical 500 μ s, with an internal reproducibility of \pm 0,05 V and an expanded uncertainty of \pm 0,1 V (acc. to GUM with a coverage factor of $k=3$).
- 6) **Characteristic curve:** In the range where the line of the graph is broken, you must expect higher differences between single devices within one packing unit.
- 7) **Tolerance of Measure:** Unless otherwise noted in drawing, tolerances are specified with \pm 0.1 and dimensions are specified in mm.

Revision History

Version	Date	Change
1.3	2018-11-28	New Layout
1.4	2019-09-05	Tray
1.5	2020-01-22	Maximum Ratings
1.5	2020-01-22	Maximum Ratings
1.6	2020-06-30	Not for new design

Published by OSRAM Opto Semiconductors GmbH EU RoHS and China RoHS compliant product
Leibnizstraße 4, D-93055 Regensburg
www.osram-os.com © All Rights Reserved.



此产品符合欧盟 RoHS 指令的要求；
按照中国的相关法规和标准，不含有毒有害物质或元素。

Данный компонент на территории Российской Федерации

Вы можете приобрести в компании MosChip.

Для оперативного оформления запроса Вам необходимо перейти по данной ссылке:

<http://moschip.ru/get-element>

Вы можете разместить у нас заказ для любого Вашего проекта, будь то серийное производство или разработка единичного прибора.

В нашем ассортименте представлены ведущие мировые производители активных и пассивных электронных компонентов.

Нашей специализацией является поставка электронной компонентной базы двойного назначения, продукции таких производителей как XILINX, Intel (ex.ALTERA), Vicor, Microchip, Texas Instruments, Analog Devices, Mini-Circuits, Amphenol, Glenair.

Сотрудничество с глобальными дистрибьюторами электронных компонентов, предоставляет возможность заказывать и получать с международных складов практически любой перечень компонентов в оптимальные для Вас сроки.

На всех этапах разработки и производства наши партнеры могут получить квалифицированную поддержку опытных инженеров.

Система менеджмента качества компании отвечает требованиям в соответствии с ГОСТ Р ИСО 9001, ГОСТ РВ 0015-002 и ЭС РД 009

Офис по работе с юридическими лицами:

105318, г.Москва, ул.Щербаковская д.3, офис 1107, 1118, ДЦ «Щербаковский»

Телефон: +7 495 668-12-70 (многоканальный)

Факс: +7 495 668-12-70 (доб.304)

E-mail: info@moschip.ru

Skype отдела продаж:

moschip.ru

moschip.ru_4

moschip.ru_6

moschip.ru_9