

Single-line low capacitance Transil™ for ESD protection

Features

- Breakdown voltage $V_{BR} = 14.2 \text{ V min.}$
- Unidirectional device
- Multiple ESD strike sustainability
- Very low diode capacitance: 6 pF typ. at 0 V
- Low leakage current
- 0201 SMD package size compatible
- Ultra small PCB area: 0.18 mm^2
- RoHS compliant

Benefits

- High ESD protection level
- High integration
- Suitable for high density boards
- MSL1

Complies with the following standards:

- IEC 61000-4-2 level 4

Applications

Where transient overvoltage protection in ESD sensitive equipment is required, such as:

- Portable multimedia players and accessories
- Notebooks
- Digital cameras and camcorders
- Communication systems
- Cellular phone handsets and accessories

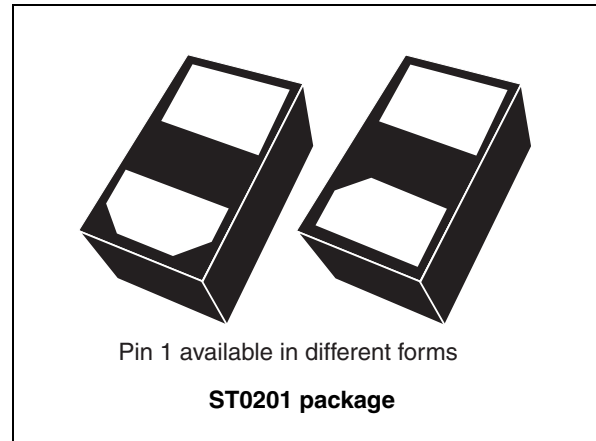
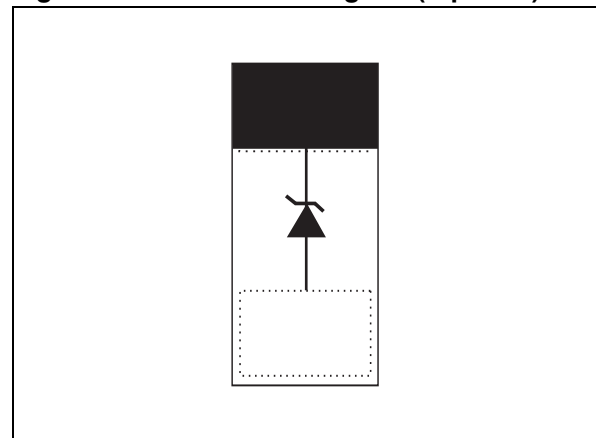

Figure 1. Functional diagram (top view)



Description

The ESDALC14V2-1U2 is a unidirectional single line TVS diode designed to protect the data lines or other I/O ports against ESD transients.

The device is ideal for applications where both reduced line capacitance and board space saving are required.

TM: Transil is a trademark of STMicroelectronics

1 Characteristics

Table 1. Absolute maximum ratings ($T_{amb} = 25\text{ }^{\circ}\text{C}$)

Symbol	Parameter	Value	Unit
V_{PP}	Peak pulse voltage: IEC 61000-4-2 contact discharge IEC 61000-4-2 air discharge	± 8 ± 15	kV
P_{PP}	Peak pulse power dissipation (8/20 μs) ⁽¹⁾	$T_{j\text{ initial}} = T_{amb}$ 30	W
I_{PP}	Peak pulse current (8/20 μs)	1.5	A
T_j	Junction temperature	125	$^{\circ}\text{C}$
T_{stg}	Storage temperature range	- 55 to +150	$^{\circ}\text{C}$
T_L	Maximum lead temperature for soldering during 10 s	260	$^{\circ}\text{C}$
T_{op}	Operating junction temperature range	-40 to +125	$^{\circ}\text{C}$

1. For a surge greater than the maximum values, the diode will fail in short-circuit

Figure 2. Electrical characteristics (definitions)

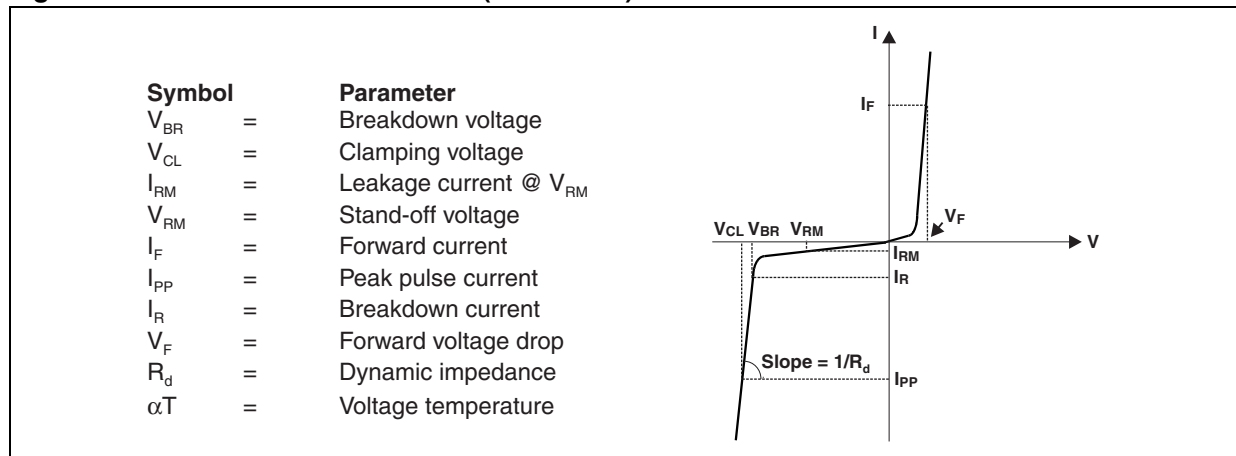

Table 2. Electrical characteristics (values, $T_{amb} = 25\text{ }^{\circ}\text{C}$)

Symbol	Test conditions	Min.	Typ.	Max.	Unit
V_{BR}	$I_R = 1\text{ mA}$	14.2	-	17.0	V
I_{RM}	$V_{RM} = 3\text{ V}$	-	-	100	nA
R_d	Square pulse, $I_{PP} = 1\text{ A}$, $t_p = 2.5\text{ }\mu\text{s}$	-	2.6	-	Ω
αT	$\Delta V_{BR} = \alpha T (T_{amb} - 25\text{ }^{\circ}\text{C}) \times V_{BR} (25\text{ }^{\circ}\text{C})$	-	-	7.2	$10^{-4}/^{\circ}\text{C}$
C_{line}	$V_R = 0\text{ V}$, $F_{osc} = 1\text{ MHz}$, $V_{osc} = 30\text{ mV}$	-	6.0	-	pF

Figure 3. Relative variation of peak pulse power versus initial junction temperature

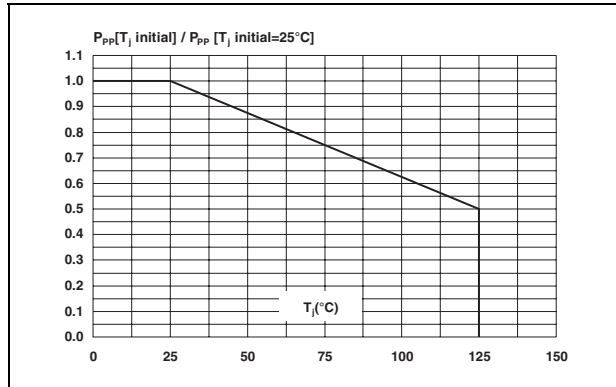

Figure 4. Peak pulse power versus exponential pulse duration

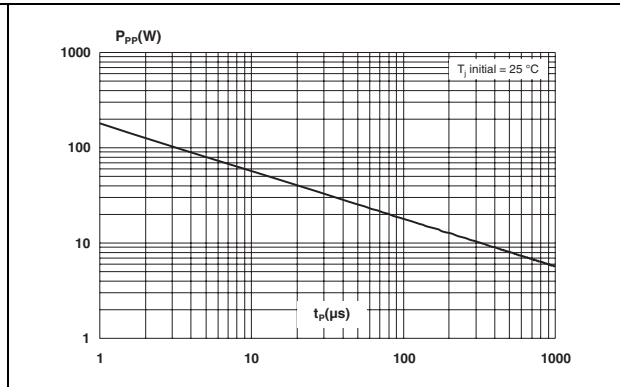

Figure 5. Clamping voltage versus peak pulse current (square pulse, typical values)

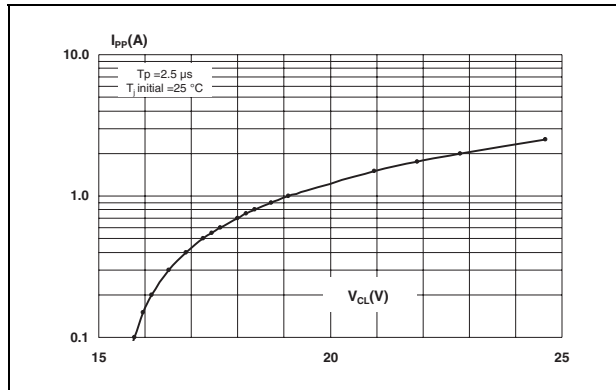

Figure 6. Junction capacitance versus reverse applied voltage (typical values)

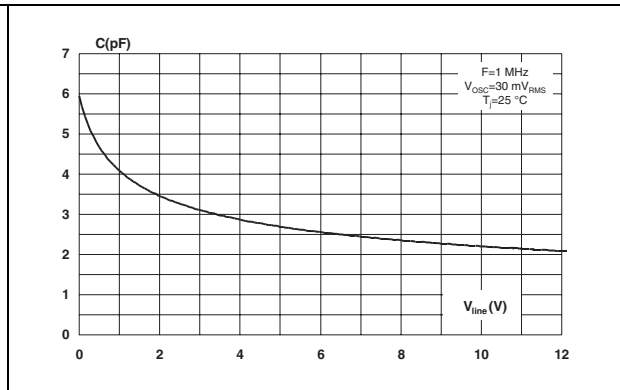

Figure 7. Relative variation of leakage current versus junction temperature (typical values)

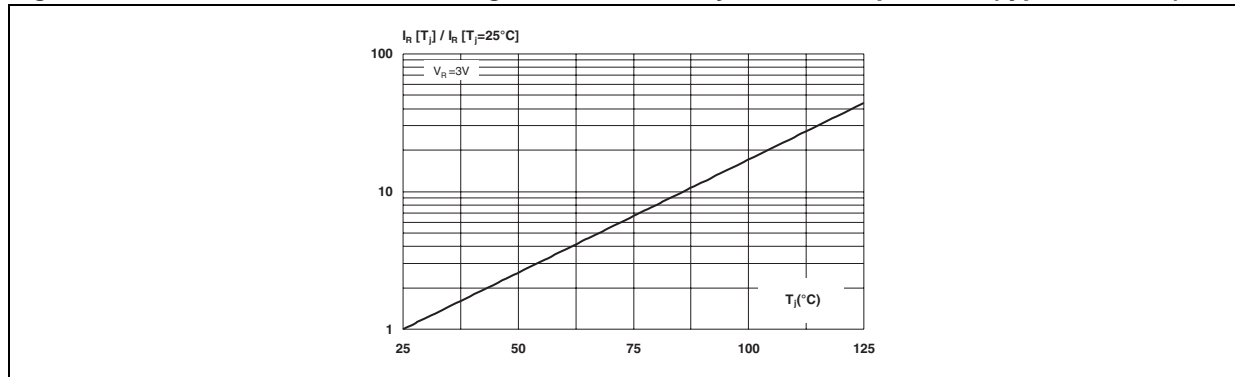

Figure 8. ESD response to IEC 61000-4-2 (+8 kV contact discharge)

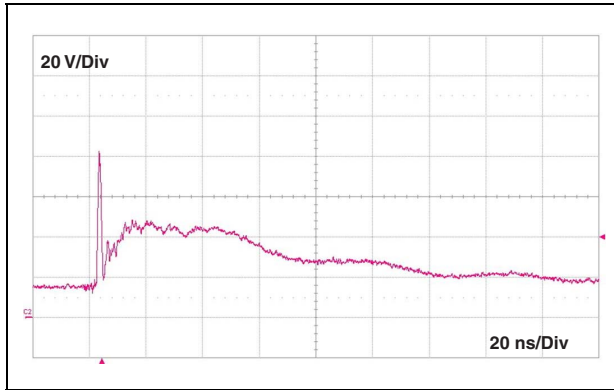

Figure 9. ESD response to IEC 61000-4-2 (-8 kV contact discharge)

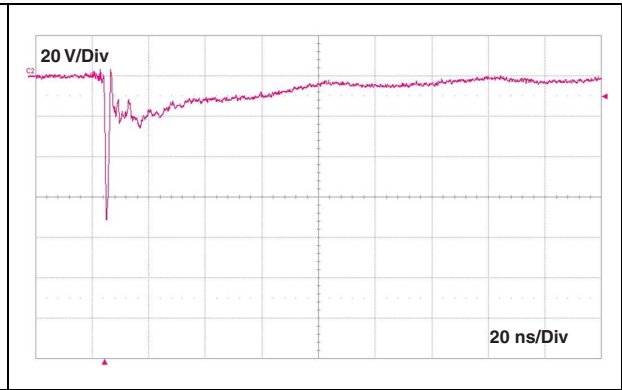

Figure 10. ESD response to IEC 61000-4-2 (+15 kV air discharge)

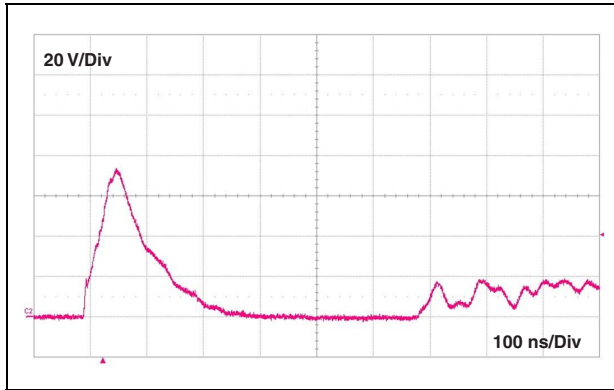

Figure 11. ESD response to IEC 61000-4-2 (-15 kV air discharge)

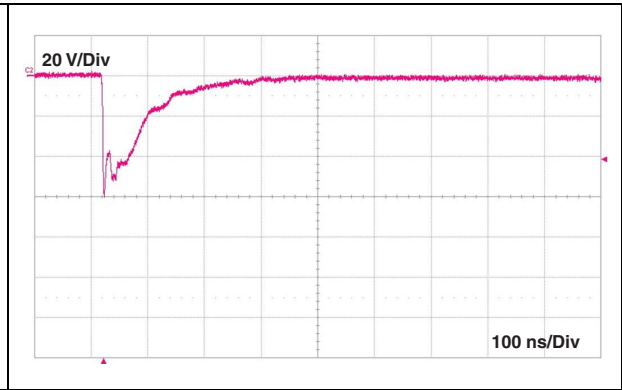
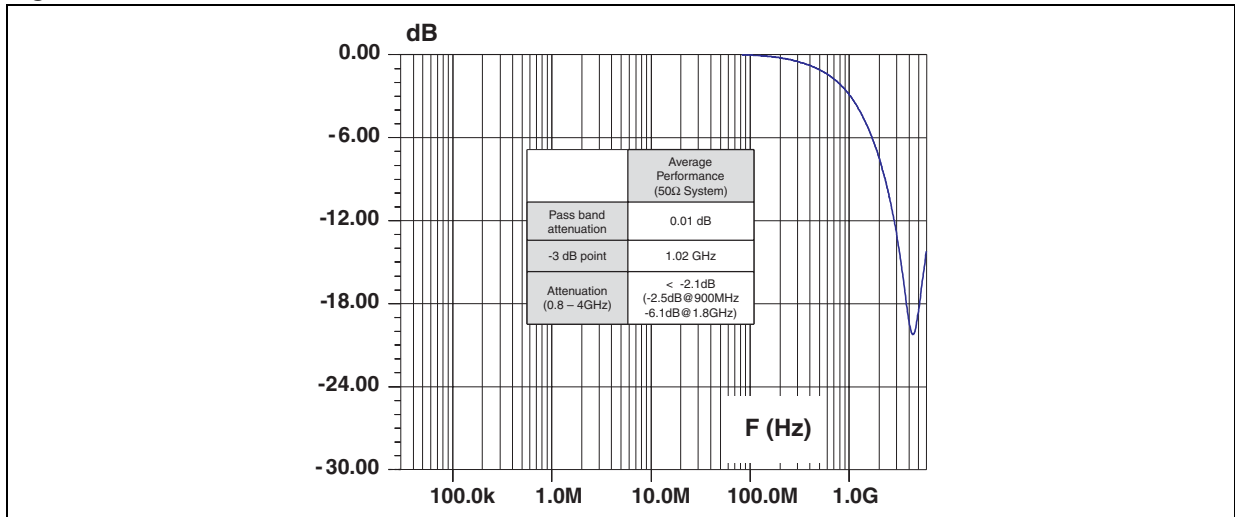
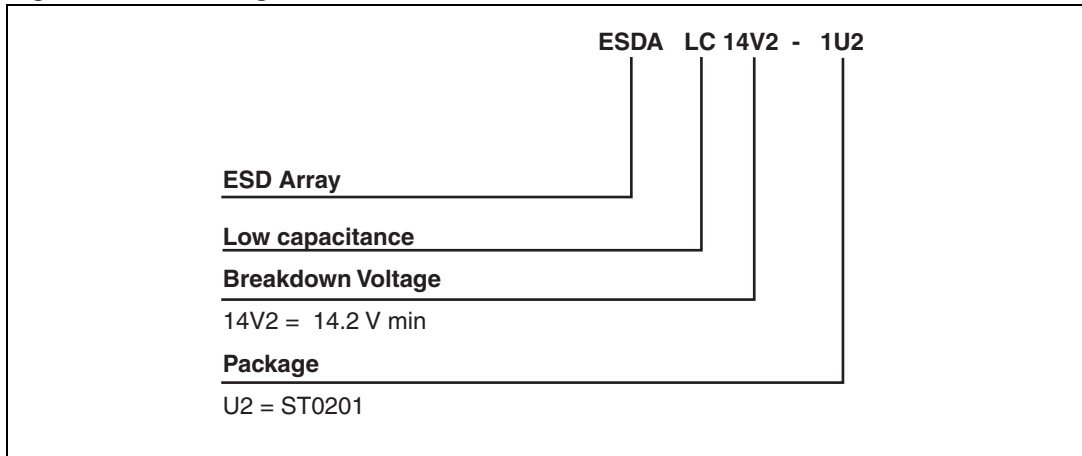

Figure 12. S21 attenuation measurement results



2 Ordering information scheme

Figure 13. Ordering information scheme



3 Package information

- Epoxy meets UL94, V0
- Lead-free packages

In order to meet environmental requirements, ST offers these devices in different grades of ECOPACK® packages, depending on their level of environmental compliance. ECOPACK® specifications, grade definitions and product status are available at: www.st.com. ECOPACK® is an ST trademark.

Table 3. ST0201 dimensions

Ref	Dimensions					
	Millimetres			Inches		
	Min.	Typ.	Max.	Min.	Typ.	Max.
A	0.23	0.28	0.33	0.009	0.011	0.013
b1	0.13	0.18	0.23	0.005	0.007	0.009
b2	0.14	0.19	0.24	0.006	0.007	0.009
D	0.55	0.60	0.65	0.022	0.024	0.026
E	0.25	0.30	0.35	0.010	0.012	0.014
e	-	0.35	-	-	0.014	-
L1	0.20	0.25	0.30	0.008	0.010	0.012
L2	0.20	0.25	0.30	0.008	0.010	0.012

Figure 14. Footprint (dimensions in mm) Figure 15. Marking

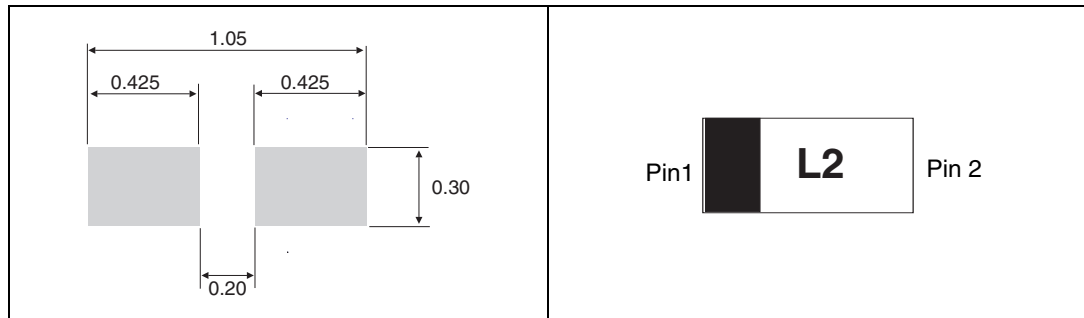

Note: Product marking may be rotated by multiples of 90° for assembly plant differentiation. In no case should this product marking be used to orient the component for its placement on a PCB. Only pin 1 mark is to be used for this purpose.

Figure 16. Tape and reel specifications

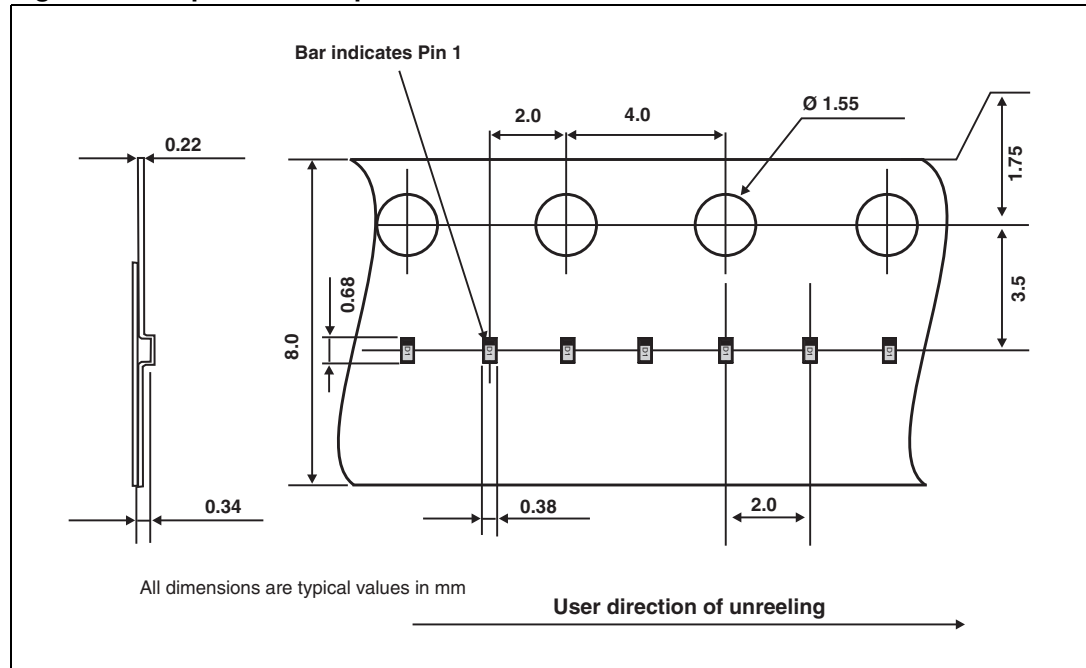

4 Recommendation on PCB assembly

4.1 Stencil opening design

Figure 17. Recommended stencil windows position (dimensions in mm)

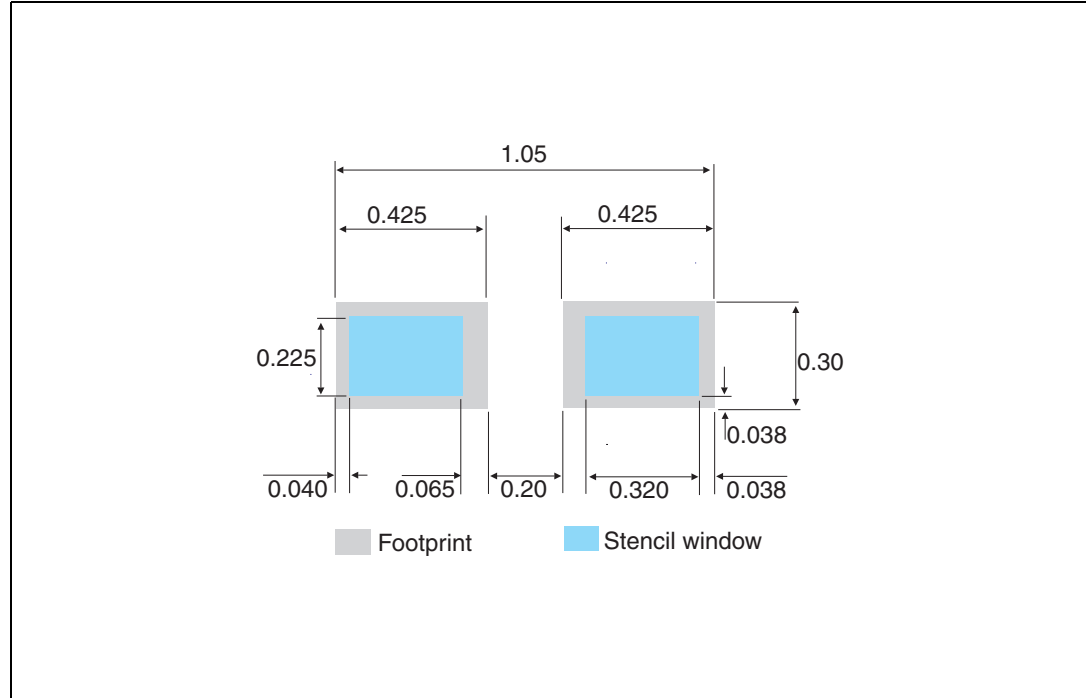

4.2 Solder paste

1. Halide-free flux qualification ROL0 according to ANSI/J-STD-004.
2. “No clean” solder paste is recommended.
3. Offers a high tack force to resist component movement during high speed
4. Solder paste with fine particles: powder particle size is 20-45 μm .

4.3 Placement

1. Manual positioning is not recommended.
2. It is recommended to use the lead recognition capabilities of the placement system, not the outline centering
3. Standard tolerance of ± 0.05 mm is recommended.
4. 3.5 N placement force is recommended. Too much placement force can lead to squeezed out solder paste and cause solder joints to short. Too low placement force can lead to insufficient contact between package and solder paste that could cause open solder joints or badly centered packages.
5. To improve the package placement accuracy, a bottom side optical control should be performed with a high resolution tool.
6. For assembly, a perfect supporting of the PCB (all the more on flexible PCB) is recommended during solder paste printing, pick and place and reflow soldering by using optimized tools.

4.4 PCB design preference

1. To control the solder paste amount, the closed via is recommended instead of open vias.
2. The position of tracks and open vias in the solder area should be well balanced. The symmetrical layout is recommended, in case any tilt phenomena caused by asymmetrical solder paste amount due to the solder flow away.

4.5 Reflow profile

Figure 18. ST ECOPACK® recommended soldering reflow profile for PCB mounting

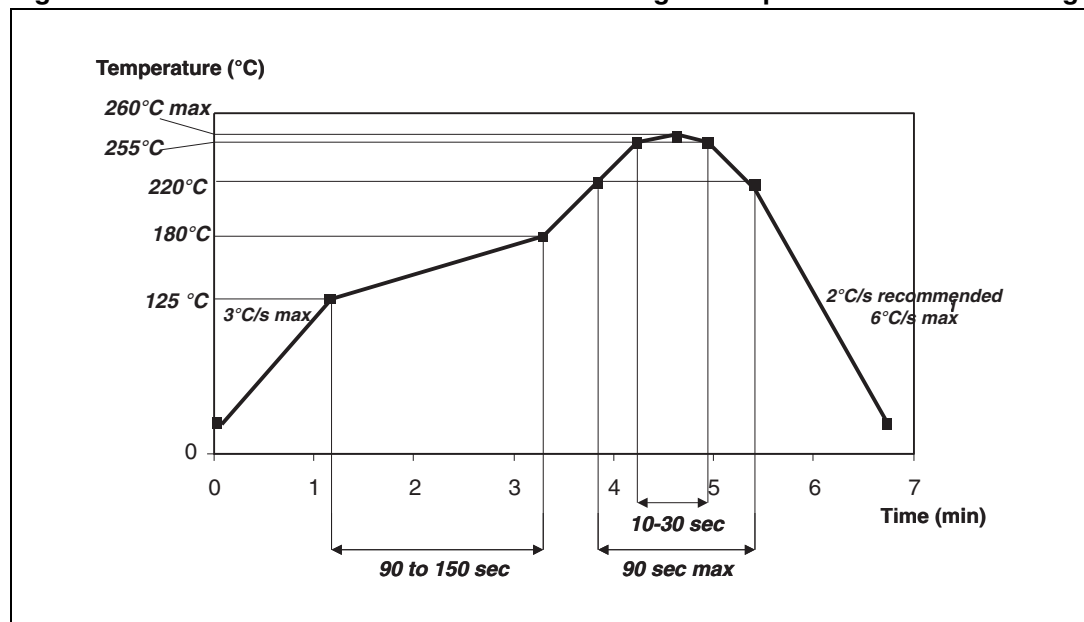

Note: Minimize air convection currents in the reflow oven to avoid component movement.

5 Ordering information

Table 4. Ordering information

Order code	Marking	Weight	Base qty	Delivery mode
ESDALC14V2-1U2	L2 ⁽¹⁾	0.124 mg	15000	Tape and reel

1. The marking can be rotated by multiples of 90° to differentiate assembly location

6 Revision history

Table 5. Document revision history

Date	Revision	Changes
07-Oct-2008	1	Initial release.
25-Jan-2010	2	Modified pin 1 form in package illustration on page 1 , and package dimension illustration in Table 3 . Updated base qty Table 4 .
23-Sep-2011	3	Additional pin 1 form included in package illustration on page 1 , and package dimension illustration in Table 3 .

Please Read Carefully:

Information in this document is provided solely in connection with ST products. STMicroelectronics NV and its subsidiaries ("ST") reserve the right to make changes, corrections, modifications or improvements, to this document, and the products and services described herein at any time, without notice.

All ST products are sold pursuant to ST's terms and conditions of sale.

Purchasers are solely responsible for the choice, selection and use of the ST products and services described herein, and ST assumes no liability whatsoever relating to the choice, selection or use of the ST products and services described herein.

No license, express or implied, by estoppel or otherwise, to any intellectual property rights is granted under this document. If any part of this document refers to any third party products or services it shall not be deemed a license grant by ST for the use of such third party products or services, or any intellectual property contained therein or considered as a warranty covering the use in any manner whatsoever of such third party products or services or any intellectual property contained therein.

UNLESS OTHERWISE SET FORTH IN ST'S TERMS AND CONDITIONS OF SALE ST DISCLAIMS ANY EXPRESS OR IMPLIED WARRANTY WITH RESPECT TO THE USE AND/OR SALE OF ST PRODUCTS INCLUDING WITHOUT LIMITATION IMPLIED WARRANTIES OF MERCHANTABILITY, FITNESS FOR A PARTICULAR PURPOSE (AND THEIR EQUIVALENTS UNDER THE LAWS OF ANY JURISDICTION), OR INFRINGEMENT OF ANY PATENT, COPYRIGHT OR OTHER INTELLECTUAL PROPERTY RIGHT.

UNLESS EXPRESSLY APPROVED IN WRITING BY TWO AUTHORIZED ST REPRESENTATIVES, ST PRODUCTS ARE NOT RECOMMENDED, AUTHORIZED OR WARRANTED FOR USE IN MILITARY, AIR CRAFT, SPACE, LIFE SAVING, OR LIFE SUSTAINING APPLICATIONS, NOR IN PRODUCTS OR SYSTEMS WHERE FAILURE OR MALFUNCTION MAY RESULT IN PERSONAL INJURY, DEATH, OR SEVERE PROPERTY OR ENVIRONMENTAL DAMAGE. ST PRODUCTS WHICH ARE NOT SPECIFIED AS "AUTOMOTIVE GRADE" MAY ONLY BE USED IN AUTOMOTIVE APPLICATIONS AT USER'S OWN RISK.

Resale of ST products with provisions different from the statements and/or technical features set forth in this document shall immediately void any warranty granted by ST for the ST product or service described herein and shall not create or extend in any manner whatsoever, any liability of ST.

ST and the ST logo are trademarks or registered trademarks of ST in various countries.

Information in this document supersedes and replaces all information previously supplied.

The ST logo is a registered trademark of STMicroelectronics. All other names are the property of their respective owners.

© 2011 STMicroelectronics - All rights reserved

STMicroelectronics group of companies

Australia - Belgium - Brazil - Canada - China - Czech Republic - Finland - France - Germany - Hong Kong - India - Israel - Italy - Japan - Malaysia - Malta - Morocco - Philippines - Singapore - Spain - Sweden - Switzerland - United Kingdom - United States of America

www.st.com

Данный компонент на территории Российской Федерации

Вы можете приобрести в компании MosChip.

Для оперативного оформления запроса Вам необходимо перейти по данной ссылке:

<http://moschip.ru/get-element>

Вы можете разместить у нас заказ для любого Вашего проекта, будь то серийное производство или разработка единичного прибора.

В нашем ассортименте представлены ведущие мировые производители активных и пассивных электронных компонентов.

Нашей специализацией является поставка электронной компонентной базы двойного назначения, продукции таких производителей как XILINX, Intel (ex.ALTERA), Vicor, Microchip, Texas Instruments, Analog Devices, Mini-Circuits, Amphenol, Glenair.

Сотрудничество с глобальными дистрибьюторами электронных компонентов, предоставляет возможность заказывать и получать с международных складов практически любой перечень компонентов в оптимальные для Вас сроки.

На всех этапах разработки и производства наши партнеры могут получить квалифицированную поддержку опытных инженеров.

Система менеджмента качества компании отвечает требованиям в соответствии с ГОСТ Р ИСО 9001, ГОСТ РВ 0015-002 и ЭС РД 009

Офис по работе с юридическими лицами:

105318, г.Москва, ул.Щербаковская д.3, офис 1107, 1118, ДЦ «Щербаковский»

Телефон: +7 495 668-12-70 (многоканальный)

Факс: +7 495 668-12-70 (доб.304)

E-mail: info@moschip.ru

Skype отдела продаж:

moschip.ru

moschip.ru_4

moschip.ru_6

moschip.ru_9