

One Cell Li-battery Linear Charger IC with Battery Temperature Detection 4.20V / 4.35V / 4.40V Charge Voltage

■ GENERAL DESCRIPTION

The XC6808 is a Constant-Voltage and Constant-Current linear charger for single-cell Li-ion and Li-polymer batteries. When the input supply is removed, XC6808 automatically enters a low battery sink state, reduce the battery sink current to 0.1uA (typ.). This IC supports temperature control based on JEITA, it possible to safely charge batteries by controlling the charge voltage(CV) and charge current(CC) according to the temperature.

The basic charging cycle consists of trickle charge mode followed by main charge mode. By connecting a resistor to the charge status output pin, it is possible to check the charge condition via the charge status output (CSO) pin voltage. The IC is housed in the small and low profile USP-6B07 package, and a charge circuit can be configured using a minimum of external components.

■ APPLICATIONS

- Smart Card
- Wireless earphone / Bluetooth earphone
- IoT equipment
- Wearable Device
- Fitness Tracker
- Hearing Aid
- Small Battery

■ FEATURES

JEITA conforming Thermistor Detect Function Built-in	
Low Profile Package	: 0.33mm max.
Operating Voltage Range	: 4.5V ~ 6.0V
Supply Current	: 100μA ($V_{IN}=5V$, $V_{BAT}=3.5V$)
Charge Current	: 5mA ~ 40mA can be set by external resistance
Charge Voltage	: 4.20V, 4.35V, 4.40V
Battery sink current	: 0.1uA (typ.)
Protection Circuit	: Thermistor detection function (Except for the XC6808xN) Safety timer function UVLO (Under Voltage Lock Out) Thermal shutdown (Latch Stop) Dropout voltage monitor function Charging over-current monitor function Recharge function
Operating Ambient Temperature	: - 40°C ~ +85°C
Package	: USP-6B07 (1.8mm x 2.0mm x 0.33mm)
Environmentally Friendly	: EU RoHS Compliant, Pb Free

■ TYPICAL APPLICATION CIRCUIT

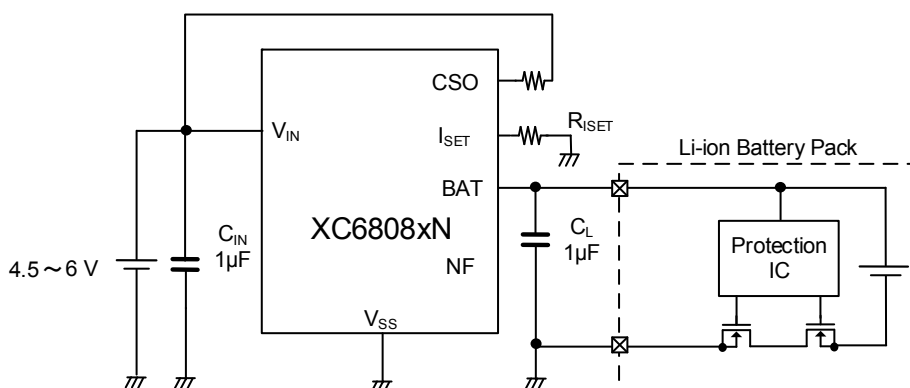

XC6808 Series

■ BLOCK DIAGRAM



(*) THIN on the XC6808x2, XC6808x3 and XC6808x4, and NF on the XC6808xN.

(*) On the XC6808xN, a resistor to the GND is built-in to invalidate the temperature monitor function.

■ PRODUCT CLASSIFICATION

XC6808①②③④⑤⑥-⑦ (*)

DESIGNATOR	DESCRIPTION	SYMBOL	DESCRIPTION
①	Charge Status Output on Abnormal Mode	A	1kHz ON-OFF
		B	OFF ※Semi-custom
②	Battery Temperature Monitor Function	2	2 Temperature Monitor ※Semi-custom
		3	3 Temperature Monitor ※Semi-custom
		4	4 Temperature Monitor (JEITA Compliant)
		N	No Temperature Monitor
③	Charge Voltage	C	4.20V
		D	4.35V
		E	4.40V
④	Main Charge Hold Time & Trickle Charge Function	1	Hold Time:5h, Trickle Charge: Enable ※Semi-custom
		2	Hold Time:10h, Trickle Charge: Enable
		3	Hold Time:5h, Trickle Charge: Disable ※Semi-custom
		4	Hold Time:10h, Trickle Charge: Disable ※Semi-custom
⑤⑥-⑦(*)	Packages (Order Unit)	8R-G	USP-6B07 (5,000pcs/Reel)

(*) The "-G" suffix denotes Halogen and Antimony free as well as being fully EU RoHS compliant.

■ PIN CONFIGURATION



*The dissipation pad for the USP-6B07 package should be solder-plated in recommended mount pattern and metal masking so as to enhance mounting strength and heat release.

When taking out a potential of the heat-sink, connect with V_{SS} pin (#2 pin).

■ PIN ASSIGNMENT

PIN NUMBER	PIN NAME	FUNCTION
USP-6B07		
1	BAT	Battery Connection
2	V _{SS}	Ground
3	CSO	Charge Status Output
4	I _{SET}	Charge Current Setup
5 ^(*)	THIN	Temperature Detection
	NF	No Function (Please do not connect any terminal.)
6	V _{IN}	Power Supply Input

^(*) Pin name of #5 is THIN on the XC6808x2, XC6808x3 and XC6808x4, and NF on the XC6808xN.

■ ABSOLUTE MAXIMUM RATINGS

T_a=25°C

PARAMETER	SYMBOL	RATING	UNIT
V _{IN} Pin Voltage	V _{IN}	-0.3 ~ +6.5	V
BAT Pin Voltage	V _{BAT}	-0.3 ~ +6.5	V
CSO Pin Voltage	V _{CSO}	-0.3 ~ +6.5	V
THIN Pin Voltage ⁽²⁾	V _{THIN}	-0.3 ~ V _{IN} +0.3 or +6.5 ⁽¹⁾	V
NF Pin Voltage ⁽³⁾	V _{NF}	-0.3 ~ V _{IN} +0.3 or +6.5 ⁽¹⁾	V
I _{SET} Pin Voltage	V _{ISET}	-0.3 ~ V _{IN} +0.3 or +6.5 ⁽¹⁾	V
BAT Pin Current	I _{BAT}	1000	mA
Power Dissipation	USP-6B07	Pd	120
			750 (PCB mounted) ⁽⁴⁾
Operating Ambient Temperature	T _{opr}	-40 ~ +85	°C
Storage Temperature	T _{stg}	-55 ~ +125	°C

Each rating voltage is based on the V_{SS}.

⁽¹⁾ Either of lower one, V_{IN}+0.3 or +6.5, is applicable.

⁽²⁾ Applicable only to XC6808x2, XC6808x3 and XC6808x4.

⁽³⁾ Applicable only to XC6808xN.

⁽⁴⁾ It is reference data on the power dissipation when mounting the board. For mounting conditions, see page 19.

ELECTRICAL CHARACTERISTICS

Unless otherwise stated, $V_{IN}=5.0V$, $V_{THIN}=1.0V$, $R_{ISET}=59k\Omega$, $C_{IN}=C_L=1\mu F$, $T_a=25^\circ C$

PARAMETER	SYMBOL	CONDITION	MIN.	TYP.	MAX.	UNIT	CIRCUIT
Operating Voltage Range	V_{IN}	(⁴)	4.5	5.0	6.0	V	-
Supply Current (¹)	I_{SS}	$V_{BAT}=3.5V$	-	100	-	μA	①
Standby Current	I_{STB}	$V_{BAT}=V_{BAC} + 100mV$, $I_{STB}=I_{IN} - I_{THIN}$	-	60	-	μA	①
$V_{IN}-V_{BAT}$ Shut-down Voltage	V_{IBSD}	$V_{BAT}=4.1V$	-	$V_{BAT}+70$	-	mV	②
Shut-down Hysteresis Voltage	$V_{IBSDHYS}$		-	37	-	mV	②
UVLO Voltage	V_{UVLO}		3.6	3.8	4.0	V	②
UVLO Hysteresis Voltage	$V_{UVLOHYS}$		-	200	-	mV	②
Trickle Charge Voltage (⁵)	V_{TRK}		2.8	2.9	3.0	V	②
Trickle Charge Hysteresis Voltage (⁵)	V_{TRKHYS}		-	100	-	mV	②
Trickle Charge Current (Min.) (¹) (⁵)	I_{TRKI}	$R_{ISET}=59k\Omega$, $V_{BAT}=2.4V$	-	0.5	-	mA	②
Trickle Charge Current (⁵)	I_{TRK}	$R_{ISET}=20k\Omega$, $V_{BAT}=2.4V$	0.9	1.2	1.8	mA	②
Trickle Charge Current (Max.) (¹) (⁵)	I_{TRKA}	$R_{ISET}=5.9k\Omega$, $V_{BAT}=2.4V$	-	4	-	mA	②
Charge Voltage	V_{BAC}	$I_{BAT}=20mA$, XC6808xxC	4.17	4.20	4.23	V	③
		$I_{BAT}=20mA$, XC6808xxD	4.32	4.35	4.38	V	③
		$I_{BAT}=20mA$, XC6808xxE	4.37	4.40	4.43	V	③
Hot Charge Voltage	V_{BAC_HT}	$I_{BAT}=20mA$, $V_{THIN}=V_{THIN_open} \times V_{T45}$ (²) XC6808x4C	4.02	4.05	4.08	V	③
		$I_{BAT}=20mA$, $V_{THIN}=V_{THIN_open} \times V_{T45}$ (²) XC6808x4D	4.17	4.20	4.23	V	③
		$I_{BAT}=20mA$, $V_{THIN}=V_{THIN_open} \times V_{T45}$ (²) XC6808x4E	4.22	4.25	4.28	V	③
Charge Current (Min.) (¹)	I_{BACI}	$R_{ISET}=59k\Omega$, $V_{BAT}=3.1V$	-	5	-	mA	②
		$R_{ISET}=59k\Omega$, $V_{BAT}=3.1V$ $V_{THIN}=V_{THIN_open} \times V_{T10}$ (³)	-	2.3	-	mA	②
Charge Current	I_{BAC}	$R_{ISET}=20k\Omega$, $V_{BAT}=3.1V$	11	13	15	mA	②
		$R_{ISET}=20k\Omega$, $V_{BAT}=3.1V$ $V_{THIN}=V_{THIN_open} \times V_{T10}$ (³)	4	6	8	mA	②
Charge Current (Max.) (¹)	I_{BACA}	$R_{ISET}=5.9k\Omega$, $V_{BAT}=3.1V$	-	40	-	mA	②
		$R_{ISET}=5.9k\Omega$, $V_{BAT}=3.1V$ $V_{THIN}=V_{THIN_open} \times V_{T10}$ (³)	-	18.4	-	mA	②
Charge Completion Current (Min.) (¹)	I_{FINI}	$R_{ISET}=59k\Omega$	-	0.5	-	mA	③
Charge Completion Current	I_{FIN}	$R_{ISET}=20k\Omega$	0.9	1.5	2.5	mA	③
Charge Completion Current (Max.) (¹)	I_{FINA}	$R_{ISET}=5.9k\Omega$	-	4.4	-	mA	③
Over Current Protection Threshold	I_{COP}		-	110	-	mA	③

(¹) Design target

(²) Applicable only to XC6808x4.

(³) Applicable only to XC6808x3 and XC6808x4.

(⁴) $V_{IN} = V_{BAC} + 150mV$

(⁵) Applicable only to XC6808xxx1 and XC6808xxx2.

■ ELECTRICAL CHARACTERISTICS

Unless otherwise stated, $V_{IN}=5.0V$, $V_{THIN}=1.0V$, $R_{ISET}=59k\Omega$, $C_{IN}=C_L=1\mu F$, $T_a=25\text{ }^\circ\text{C}$

PARAMETER	SYMBOL	CONDITION	MIN.	TYP.	MAX.	UNIT	CIRCUIT
Driver ON Resistance	R_{ON}	$V_{IN}=4.1V$, $R_{ISET}=5.9k\Omega$ $I_{BAT}=30mA$	-	3.0	5.5	Ω	③
Driver Leakage Current	I_{LEAK}	$V_{IN}=6.0V$, $V_{BAT}=0V$	-	-	1	μA	⑥
BAT Sink Current at UVLO	$I_{BSCUVLO}$	$V_{BAT}=4.5V$, $V_{IN}=0V$	-	0.1	0.5	μA	⑥
BAT Sink Current	I_{BSC}	$V_{BAT}=V_{BAC}+20mV$, $V_{IN}=5.0V$	-	3	-	μA	②
Recharge Voltage	V_{RCHG}		3.70	3.90	4.10	V	②
		$V_{THIN}=V_{THIN_open} \times V_{T45}^{(*)}$	3.55	3.75	3.95	V	②
Trickle Charge Hold Time ^(*) ⁽⁹⁾	t_{TRK}		-	0.5	-	hr	②
Main Charge Hold Time ^(*)	t_{CHG}	XC6808xxx1	-	5	-	hr	②
		XC6808xxx2	-	10	-	hr	②
CSO Pin OFF Current	I_{CSO_OFF}	$V_{CSO}=6.0V$	-	-	1	μA	⑦
CSO Pin ON Voltage	V_{CSO}	$I_{CSO}=10mA$	-	-	0.5	V	④
Thermal Shut-Down Detection Temperature	T_{TSD}		-	140	-	$^\circ\text{C}$	②
CSO Frequency ^(*)	f_{CSO}		0.75	1.00	1.25	kHz	②

^(*) Applicable only to XC6808x4.

^(*) Applicable only to XC6808A.

^(*) Design target.

^(*) Applicable only to XC6808xxx1 and XC6808xxx2.

ELECTRICAL CHARACTERISTICS

XC6808x2, XC6808x3, XC6808x4 ^{(*)1} Unless otherwise stated, $V_{IN}=5.0V$, $V_{THIN}=1.0V$, $R_{ISET}=59k\Omega$, $C_{IN}=C_L=1\mu F$, $T_a=25\text{ }^\circ C$

PARAMETER	SYMBOL	CONDITION	MIN.	TYP.	MAX.	UNIT	CIRCUIT
THIN Pin Open Voltage	V_{THIN_open}		1.94	2.00	2.06	V	⑤
Battery Connect Detection	V_{TD}		77	80	83	% ^{(*)10}	②
Battery Connect Detection Hysteresis	V_{TDH}	At temperature fall	-	3	-	% ^{(*)10}	②
Thermistor Detection at 0°C	V_{T0}		71.13	73.13	75.13	% ^{(*)10}	②
Thermistor Detection Hysteresis at 0°C ^(*)	V_{T0H}	At temperature rise	-	2.18	-	% ^{(*)10}	②
Thermistor Detection at 10°C ^{(*)12}	V_{T10}		62.19	64.19	66.19	% ^{(*)10}	②
Thermistor Detection Hysteresis at 10°C	V_{T10H}	At temperature rise	-	2.38	-	% ^{(*)10}	②
Thermistor Detection at 45°C	V_{T45}		30.96	32.96	34.96	% ^{(*)10}	②
Thermistor Detection Hysteresis at 45°C	V_{T45H}	At temperature fall	-	1.94	-	% ^{(*)10}	②
Thermistor Detection at 60°C ^{(*)13}	V_{T60}		21.16	23.16	25.16	% ^{(*)10}	②
Thermistor Detection Hysteresis at 60°C	V_{T60H}	At temperature fall	-	1.47	-	% ^{(*)10}	②
THIN Pin Connected Resistance	R_{THIN}	$V_{THIN} = 0 V$	9.8	10.0	10.2	kΩ	⑤

^{(*)10} The comparator detect voltage and hysteresis width are indicated as percentages of the THIN pin open voltage, V_{THIN_open} , (taken to be 100%)

$V_{Txx} = V_{Txx'} / V_{THIN_open}$ ($V_{Txx'}$: Voltage when the external voltage applied to the THIN pin sweeps and the IC internal comparator inverts)

^{(*)11} XC6808xN does not include thermistor temperature monitoring function.

^{(*)12} Applicable only to XC6808x3 and XC6808x4

^{(*)13} Applicable only to XC6808x4

TEST CIRCUITS

1) Test Circuit ①

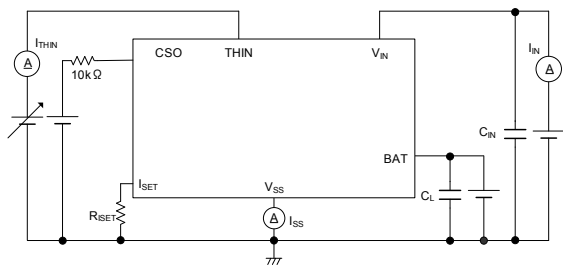

2) Test Circuit ②

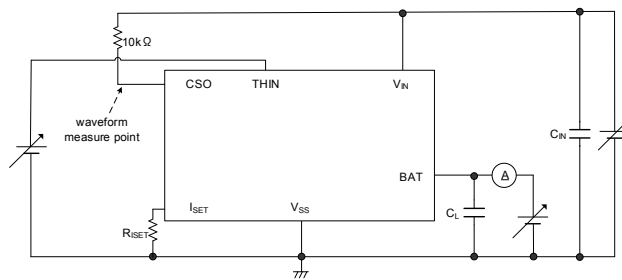

3) Test Circuit ③



4) Test Circuit ④



5) Test Circuit ⑤



6) Test Circuit ⑥



7) Test Circuit ⑦



XC6808 Series

TYPICAL APPLICATION CIRCUIT

XC6808x2, XC6808x3, XC6808x4



XC6808xN



【Recommended Parts】

	MANUFACTURE	PRODUCT NUMBER	VALUE
C_{IN}	TAIYO YUDEN	LMK107BJ105KA	1µF/10V
C_L	TAIYO YUDEN	LMK107BJ105KA	1µF/10V
NTC	Murata	NCP15XH103F03RC	Resistance: 10kΩ @ 25°C B-constant (25 - 50°C): 3380K
R_{ISET}			5.9k ~ 59kΩ

OPERATIONAL EXPLANATION

<Charge Function>

XC6808xxx2



XC6808xxx4

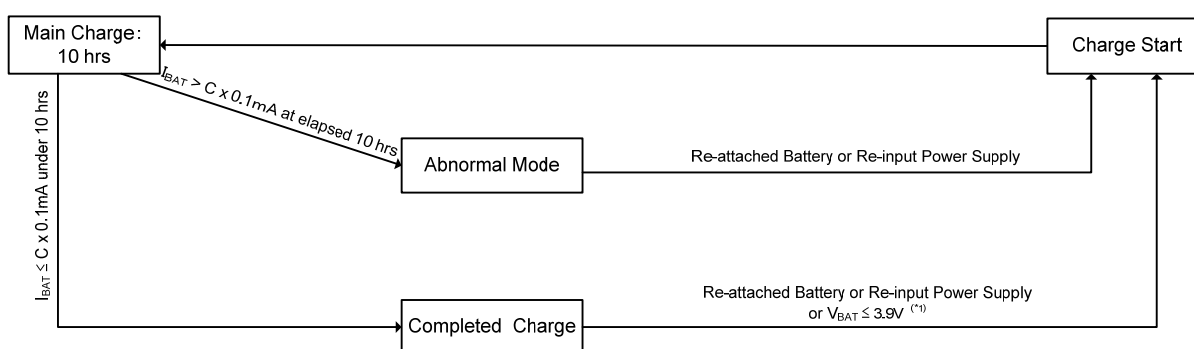

●Charging start

When a thermistor is connected to the THIN pin after a voltage is applied to the power input pin (①), or when a voltage is applied to the power input pin after a thermistor is connected to the THIN pin (②), the power on reset function activates and initializes the internal counter. After 70ms elapses in the case of ①, or 50ms in the case of ②, charging starts.

●Trickle charging: Less than 0.5 hour (XC6808xxx1, XC6808xxx2)

Trickle charging determines if main charging of the Li-ion battery is possible. The Li-ion battery is charged at a trickle charge current that is one-tenth the charge current set with the external resistor (R_{ISET}). If the BAT pin voltage (V_{BAT}) is above 2.9V in the charging start state, trickle charging takes place for 1ms and then main charging begins. If V_{BAT} is less than 2.9V, trickle charging takes place, and main charging begins 20ms after 2.9V is detected. If the BAT pin voltage is less than 2.9V after 0.5 hours, the IC changes to the error state and stops charging the Li-ion battery. In addition, the error in the trickle charge current increases if V_{BAT} drops below about 1V.

●Main charging: Less than 5 hours (XC6808xxx1, XC6808xxx3), or 10 hours (XC6808xxx2, XC6808xxx4)

When the condition for transition from trickle charging is satisfied, it is determined that rapid charging of the Li-ion battery is possible and the IC changes to the main charging state. In main charging, the IC charges an Li-ion battery at a charge current that is set with R_{ISET} . If V_{BAT} rises to the charge voltage (V_{BAC}) within 5 hours (XC6808xxx1, XC6808xxx3) or 10 hours (XC6808xxx2, XC6808xxx4), the charge current drops to the charge completed current, and after 20ms elapses, the state changes to charge completed and charging stops. If the charge current is higher than the charge completed current after 5 hours (XC6808xxx1, XC6808xxx3) or 10 hours (XC6808xxx2, XC6808xxx4), an error state occurs and charging stops.

●Charging completed

When the charge current reaches the charge completion current, which is one-tenth the charge current set with R_{ISET} , and after 20ms elapses, the IC changes to charging completed and stops charging the Li-ion battery. At this time, the charge status output pin changes from ON to OFF. When V_{BAT} falls from the charge completion state to the recharge voltage (V_{RCHG}) or less, charging automatically restarts. When a voltage is reapplied to the power input pin or a Li-ion battery is reconnected to the BAT pin in the charging completed state, the IC starts up and charging begins.

OPERATIONAL EXPLANATION (Continued)

●Error state

If it is determined that charging is abnormal in any state, the IC treats this as an error state and stops charging. When the power is turned off and then on, or the battery is reinserted, the IC starts up again and charging starts. An error state occurs if 0.5 hours elapses during trickle charging, if 10 hours (or 5 hours) elapses during main charging, or if thermal shutdown, or charging overcurrent is detected.

●Charging status output pin (CSO)

The charge status output pin turns ON by Nch open drain output during trickle charging and main charging, and turns OFF after charging is completed. If an abnormal condition is detected, the charge status output pin repeats ON-OFF at 1kHz on the XC6808A, and turns off on the XC6808B.

●Charge current

The set charge current of the IC, I_{CHG} , can be set within the range 5mA to 40mA by R_{ISET} . The R_{ISET} and I_{CHG} are approximated by the following equation.

$$R_{ISET} (k\Omega) = 351 \times I_{CHG} (mA)^{-1.11}$$

●IC temperature monitoring function

In order to prevent destruction due to IC heat generation as well as abnormal charging due to thermal runaway, a thermal shutdown circuit is incorporated into the IC. If the chip temperature rises to 140°C or higher and after 20ms elapses, the output driver is turned off and charging is stopped. At this time, the charge status output pin repeats ON-OFF at 1kHz on the XC6808A, and turns off on the XC6808B. When voltage is reapplied to the power input pin or the Li-ion battery is reconnected to the BAT pin, the IC starts and charging begins.

●Dropout voltage monitoring function

To prevent reverse current from the Li-ion battery to the battery charger, this function monitors the dropout voltage between the BAT pin voltage (V_{BAT}) and power input pin voltage (V_{IN}). When the V_{IN} falls to $V_{BAT} + 70mV$, the function turns off the output driver and switches the backgating connection of the driver from the power pin to the BAT pin. When V_{IN} rises higher than $V_{BAT} + 0.1V$, this function is released, the output driver turns ON, and the driver backgate connects to the power pin and charging resumes. In addition, this function continues the t_{CHG} count even when charging is stopped, and the charge status output pin maintains the ON state. After charging is completed, the charge status output pin remains off even if the function activates due to the input power being removed or otherwise.

●UVLO function

A UVLO function is incorporated. If the power input pin falls to 3.8V or lower during charging, this function turns off the output driver and stops charging. In addition, charge status output pin changes to OFF. When the power input pin rises to 4V or higher, the IC starts up and charging begins. This function also detects voltage application to the power input pin.

●Charge over-current monitoring function

To prevent charging of a battery by excessive current, this function stops charging if the charge current rises to 110mA or higher and after 20ms elapses. At this time, the charge status output pin repeats ON-OFF at 1kHz on the XC6808A, and turns off on the XC6808B.

When voltage is reapplied to the power input pin or the Li-ion battery is reconnected to the BAT pin, the IC starts up and charging begins. ^(*)

●Recharge function

With the completion of charging, when the NTC thermistor temperature is 0°C or higher and less than 45°C, and the BAT pin voltage (V_{BAT}) falls to 3.9V or less and after 70ms elapses, charging resumes.

On the XC6808x4, if the NTC thermistor temperature is 0°C or higher, less than 45°C and BAT pin voltage (V_{BAT}) drops less than 3.9V, charging automatically resumes. If the NTC thermistor temperature is 45°C or higher and less than 60°C, charging automatically resumes when the voltage falls to 3.75V or less.

^(*) Insertion and removal of the battery is detected by thermistor connection (THIN pin voltage). For this reason, restarting of the IC is not possible by battery reinsertion on the XC6808xN, as the THIN voltage is fixed to the internal IC. When voltage is reapplied to the power input pin, the IC starts up and charging begins.

OPERATIONAL EXPLANATION (Continued)

● Li-ion battery temperature monitoring function ^{(*)2}

The IC monitors the Li-ion battery temperature during charging by means of an NTC thermistor (“thermistor” below) connected to the THIN pin. The charge voltage V_{BAC} and the charge current I_{BAT} are controlled based on the Li-ion battery temperature as shown below to enable safe charging. The charge state changes after the Li ion battery temperature reaches each of the change points and after 20ms elapses.

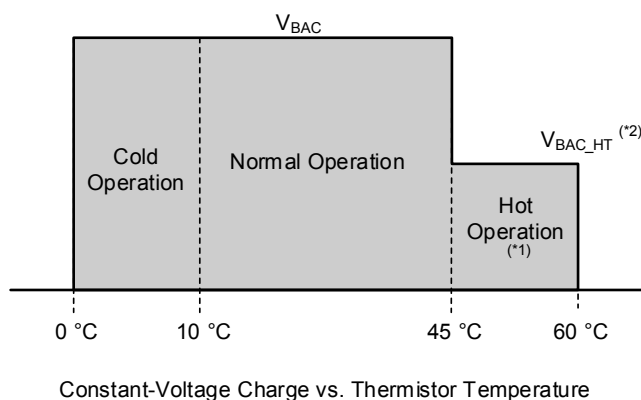
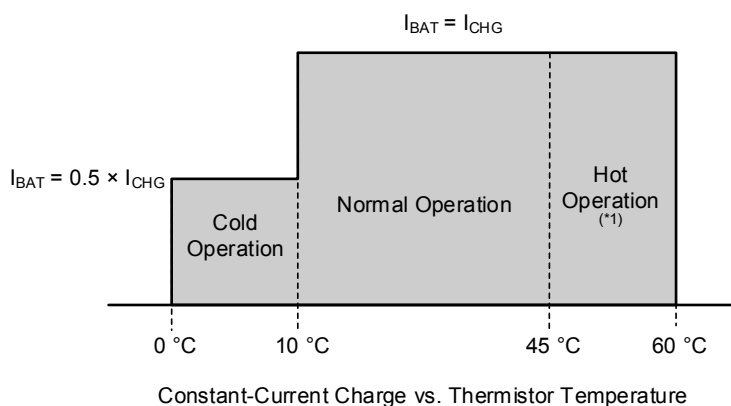

●XC6808x4 (4 temperatures monitoring)

Cold Operation

When $0^{\circ}\text{C} < \text{NTC Temperature} \leq 10^{\circ}\text{C}$, the CC charge current is limited to $I_{CHG} \times 0.5$. ^{(*)3}

When $\text{NTC Temperature} \leq 0^{\circ}\text{C}$, charging stops. ^{(*)4}

Normal Operation

When $10^{\circ}\text{C} < \text{NTC Temperature} < 45^{\circ}\text{C}$, charging takes place with the charge current I_{CHG} and the charge voltage at V_{BAC_HT} . ^{(*)3}

Hot Operation

When $45^{\circ}\text{C} \leq \text{NTC Temperature} < 60^{\circ}\text{C}$, the charge voltage changes to V_{BAC_HT} and charging continues. ^{(*)3}

When $60^{\circ}\text{C} \leq \text{Thermistor Temperature}$, charging stops. ^{(*)4}

●XC6808x3 (3 temperatures monitoring)

Comparing to the XC6808x4, the XC6808x3 does not monitor at 60°C and charging stops at $45^{\circ}\text{C} \leq \text{Thermistor Temperature}$. ^{(*)3}

●XC6808x2 (2 temperatures monitoring)

In contrast to the XC6808x4, the XC6808x2 does not have 10°C and 60°C monitoring, and stops charging when Thermistor Temperature $\leq 0^{\circ}\text{C}$ and when Thermistor Temperature $\geq 45^{\circ}\text{C}$. ^{(*)4}

In addition, when $0^{\circ}\text{C} < \text{Thermistor Temperature} \leq 10^{\circ}\text{C}$, the charge current does not change from I_{CHG} . ^{(*)3}

^{(*)2} On the XC6808xN, battery temperature protection function is not built in.

^{(*)3} During trickle charging, the charge current is limited to $I_{CHG} \times 0.1$.

^{(*)4} Even when charging is stopped, t_{TRK} count and t_{CHG} count are continued and the charge status output pin maintains the ON state.

The NTC temperature detection of this IC conforms to the characteristics of the NCP15XH103F03RC of Murata Manufacturing Co., Ltd.

OPERATIONAL EXPLANATION (Continued)

Timing chart example
XC6808x4x2

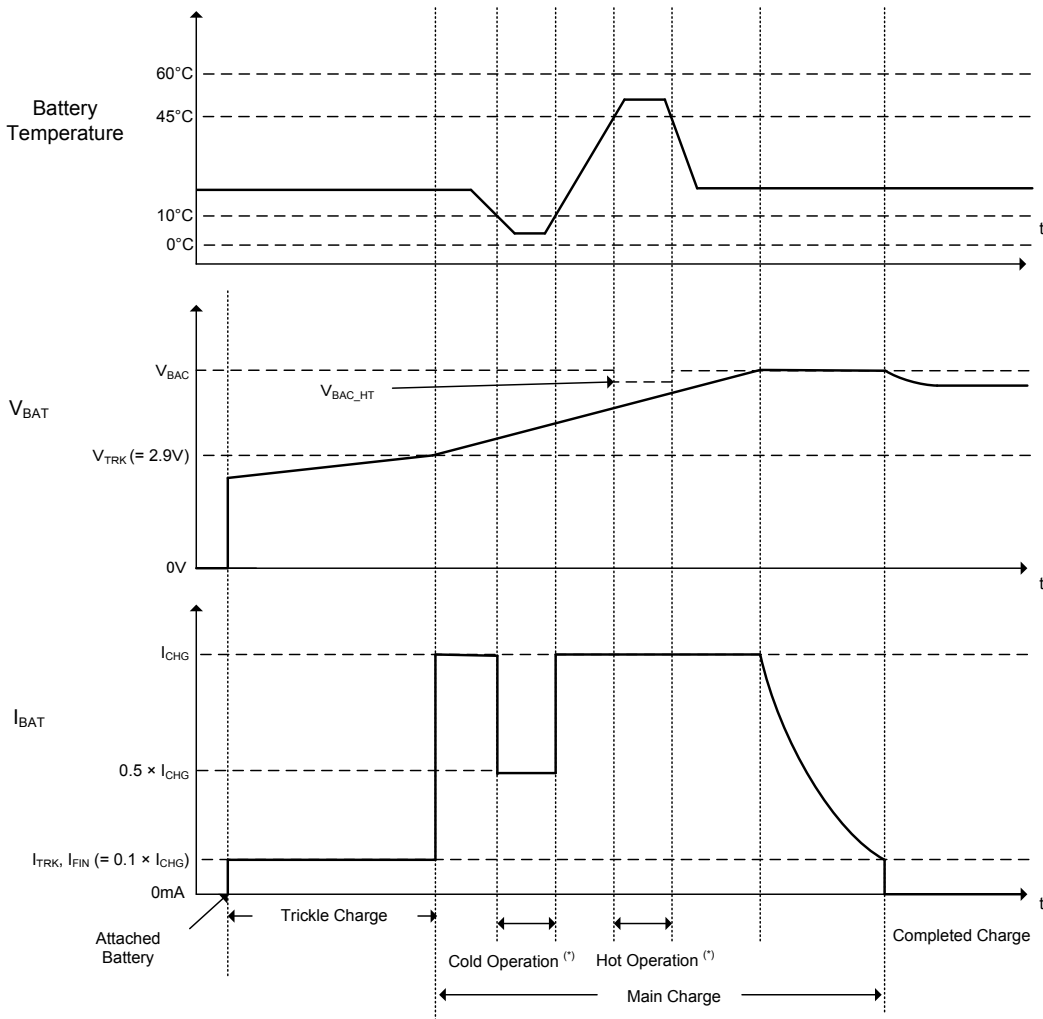

(*) With regard to the details of Cold operation and Hot Operation, please see "Li-ion battery temperature monitoring function" in the Operational Explanation.

■ OPERATIONAL EXPLANATION (Continued)

Timing chart example
XC6808xNx2

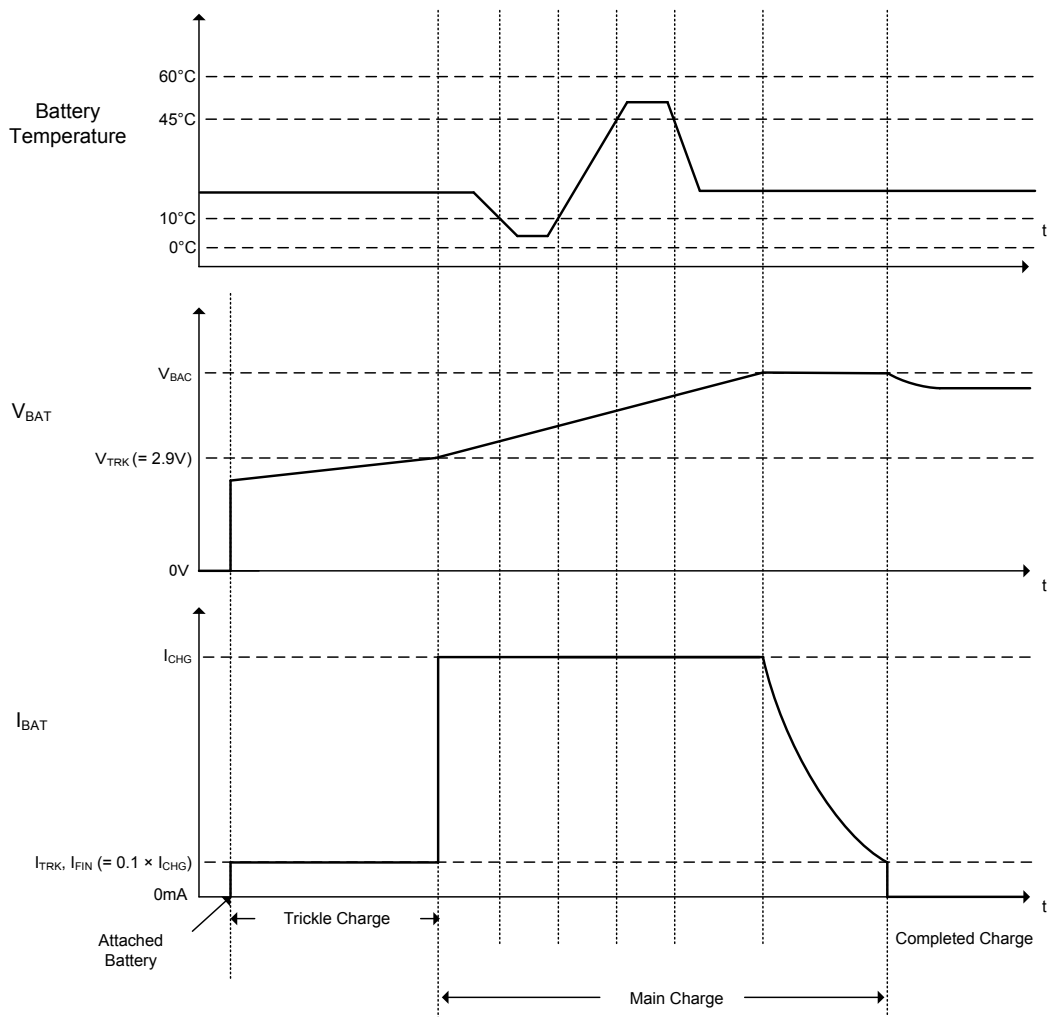

■ NOTES ON USE

1. For temporary, transitional voltage drop or voltage rising phenomenon, the IC is liable to malfunction should the ratings be exceeded.
2. Where wiring impedance is high, operations may become unstable. Please strengthen VIN and VSS wiring in particular.
3. Please mount the C_{IN} , C_L and charge current setting resistor as close to the IC as possible.
4. Do not connect anything other than a resistance for setting the charge current to the I_{SET} pin.
5. Torex places an importance on improving our products and their reliability.
We request that users incorporate fail-safe designs and post-aging protection treatment when using Torex products in their systems.
6. This IC uses an external thermistor to detect and control temperature with high accuracy.
Please sufficiently test the position of the external thermistor to ensure that it enables accurate temperature detection.
7. Reversing the polarity of the battery may cause destruction and is extremely dangerous. Never reverse the polarity of the battery.
8. Short-circuiting to neighboring pins may cause malfunctioning and destruction. Exercise sufficient caution when mounting and using the IC.
9. If a large ripple voltage occurs at the V_{IN} pin, the IC may malfunction. Please test thoroughly.
10. Taking the temperature characteristics and the dispersion into consideration, please set the charge current not to exceed the range of 5mA to 40mA.
11. If the I_{SET} pin is shorted to the GND, there is a possibility that the IC is destroyed before the over-current monitor function is activated.
12. When V_{BAT} is 1 V or less, the error range of the trickle charge current becomes large. When $V_{IN} - V_{BAT}$ voltage is high in particular, please pay attention when using as there are possibilities that a large trickle current flows.
13. On the XC6808xN, please be sure to use the NF pin (pin #5) in the open state.

TYPICAL PERFORMANCE CHARACTERISTICS

(1) CC Charge Current vs. External Resistor (Normal Operation)



(2) CC Charge Current vs. Ambient Temperature (Normal Operation)



(3) Battery Charge Current vs. BAT Pin Voltage
($R_{SET} = 59 \text{ k}\Omega$, $CV=4.35V$, Normal Operation)



(4) Battery Charge Current vs. BAT Pin Voltage
($R_{SET} = 20 \text{ k}\Omega$, $CV=4.35V$, Normal Operation)



(5) Battery Charge Current vs. BAT Pin Voltage
($R_{SET} = 5.9 \text{ k}\Omega$, $CV=4.35V$, Normal Operation)

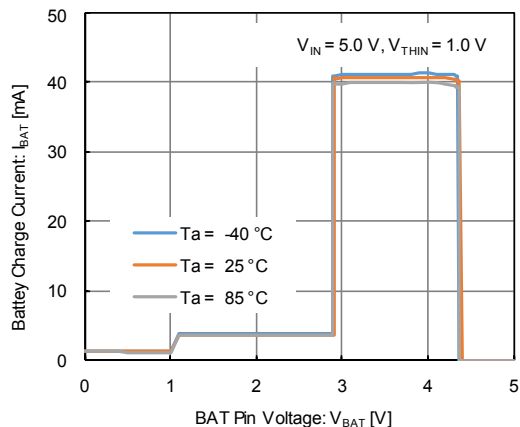

(6) Charge Completion Current vs. Ambient Temperature

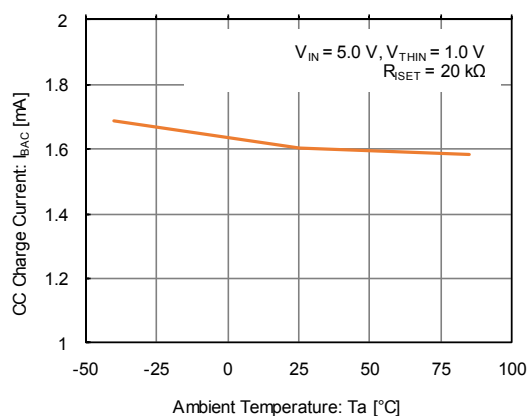

TYPICAL PERFORMANCE CHARACTERISTICS(Continued)

(7) Supply Current vs. Ambient Temperature

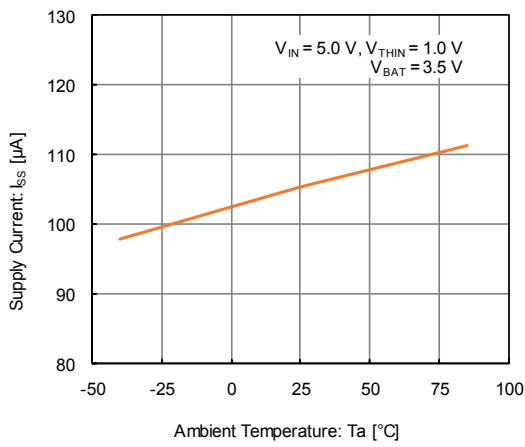

(8) Standby Current vs. Ambient Temperature

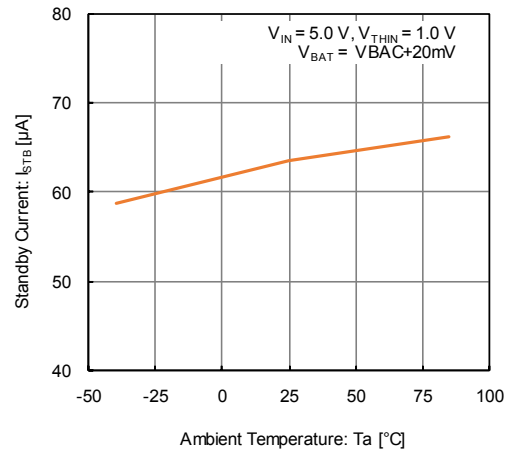

(9) Driver ON Resistance vs. Ambient Temperature

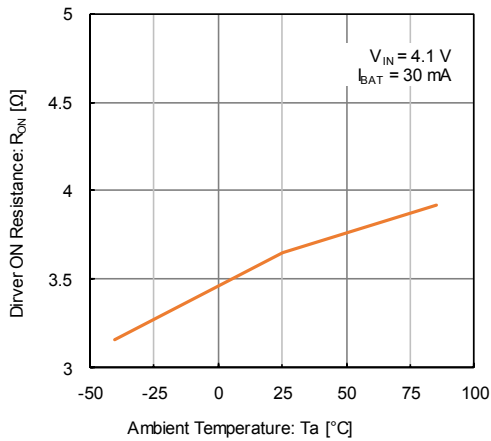

(10) Driver Leakage Current vs. Ambient Temperature

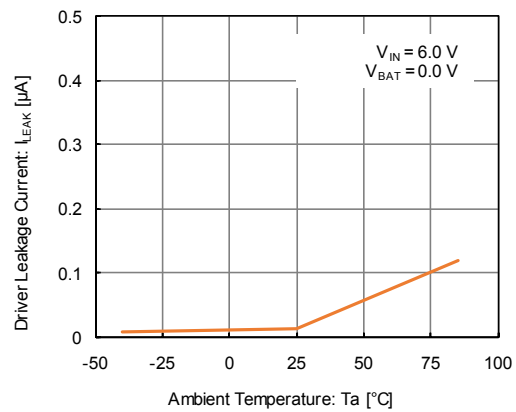

(11) BAT Sink Current vs. Ambient Temperature

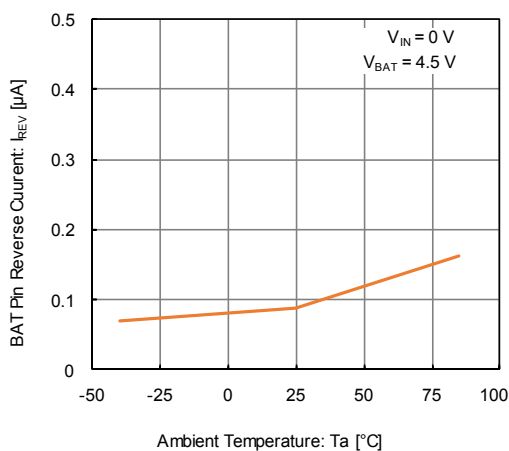

(12) BAT Pin Pull-down Current vs. Ambient Temperature

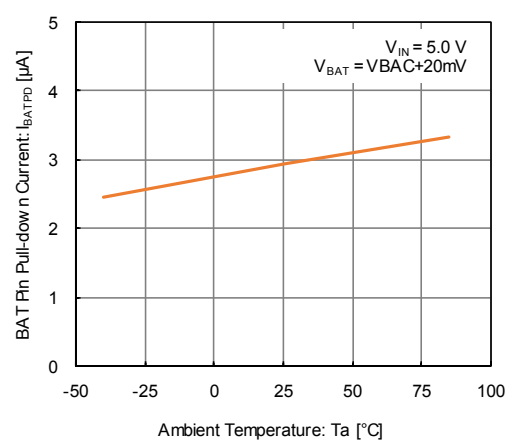

■ PACKAGING INFORMATION

● USP-6B07 (Preliminary)

(unit: mm)



PACKAGING INFORMATION (Continued)

- USP-6B07 Reference pattern layout

(unit: mm)

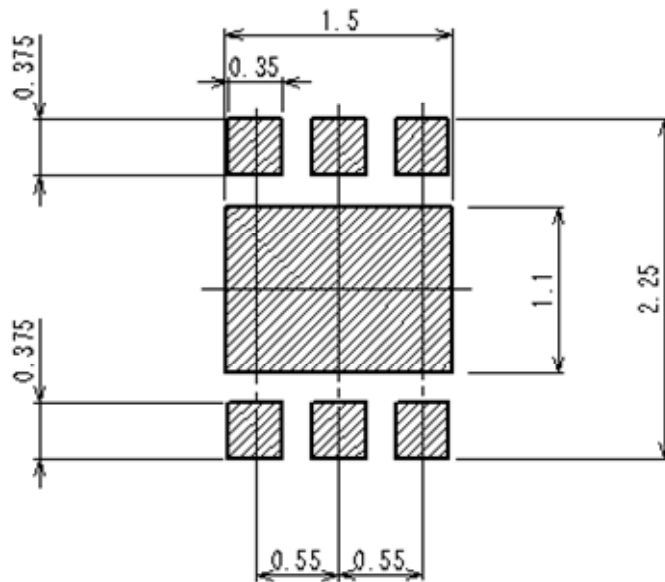

- USP-6B07 Reference metal mask design

(unit: mm)

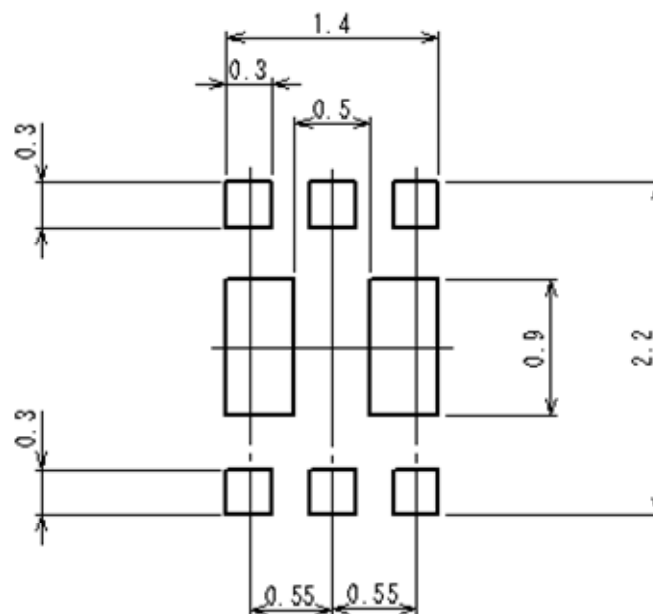

● **USP-6B07(DAF) Power Dissipation**

Power dissipation data for the USP-6B07(DAF) is shown in this page.
The value of power dissipation varies with the mount board conditions.
Please use this data as one of reference data taken in the described condition.

1. **Measurement Condition (Reference data)**

- Condition: Mount on a board
- Ambient: Natural convection
- Soldering: Lead (Pb) free
- Board: Dimensions 40 x 40 mm (1600 mm² in one side)
Copper (Cu) traces occupy 50% of the board area
in top and back faces
Package heat-sink is tied to the copper traces
- Material: Glass Epoxy (FR-4)
- Thickness: 1.6 mm
- Through-hole: 4 x 0.8 mm Diameter

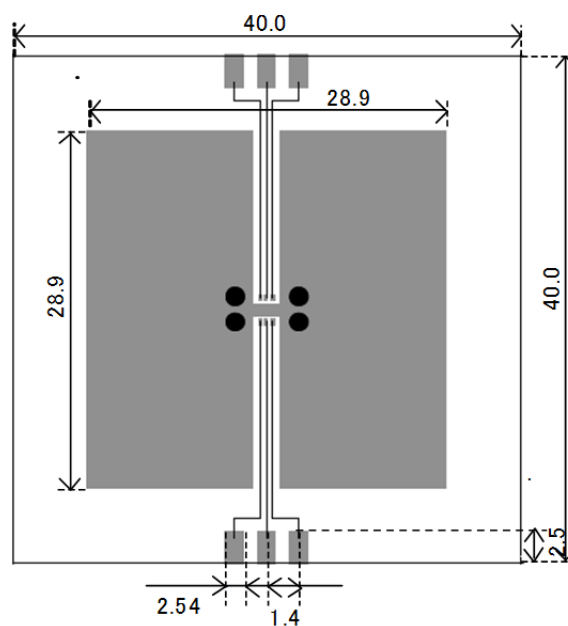

Evaluation board layout (Unit: mm)

2. **Power Dissipation vs. Ambient temperature**

Board Mount ($T_j \text{ max}=125^\circ\text{C}$)

Ambient Temperature ($^\circ\text{C}$)	Power Dissipation P_d (mW)	Thermal Resistance ($^\circ\text{C}/\text{W}$)
25	750	133.33
85	300	

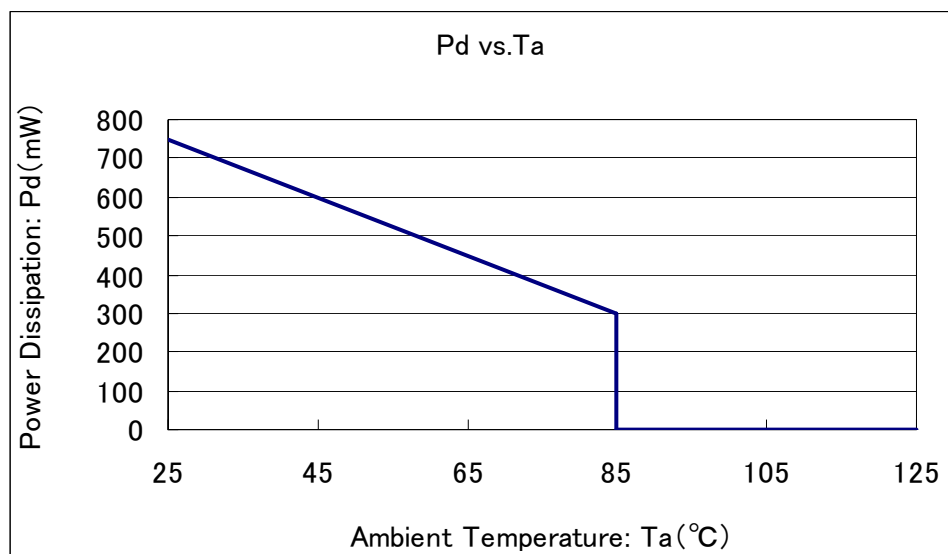

XC6808 Series

MARKING RULE

●USP-6B07

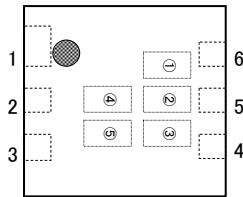

① represents product series.

MARK	PRODUCT SERIES
8	XC6808*****-G

② represents Charge Status Output on Abnormal Mode and Battery Temperature Monitor Function.

MARK	Charge Status Output on Abnormal Mode	Battery Temperature Monitor Function	PRODUCT SERIES
0	1kHz ON-OFF	2 Temperature Monitor	XC6808A2****-G
1	1kHz ON-OFF	3 Temperature Monitor	XC6808A3****-G
2	1kHz ON-OFF	4 Temperature Monitor	XC6808A4****-G
3	1kHz ON-OFF	No Temperature Monitor	XC6808AN****-G
4	OFF	2 Temperature Monitor	XC6808B2****-G
5	OFF	3 Temperature Monitor	XC6808B3****-G
6	OFF	4 Temperature Monitor	XC6808B4****-G
7	OFF	No Temperature Monitor	XC6808BN****-G

③ represents CV Charge Voltage, Main Charge Hold Time & Trickle Charge Function.

MARK	CV Charge Voltage	Main Charge Hold Time & Trickle Charge Function	PRODUCT SERIES
A	4.20V	Hold Time 5h, Trickle Charge Enable	XC6808**C1**-G
B	4.20V	Hold Time 10h, Trickle Charge Enable	XC6808**C2**-G
C	4.20V	Hold Time 5h, Trickle Charge Disable	XC6808**C3**-G
D	4.20V	Hold Time 10h, Trickle Charge Disable	XC6808**C4**-G
E	4.35V	Hold Time 5h, Trickle Charge Enable	XC6808**D1**-G
F	4.35V	Hold Time 10h, Trickle Charge Enable	XC6808**D2**-G
H	4.35V	Hold Time 5h, Trickle Charge Disable	XC6808**D3**-G
K	4.35V	Hold Time 10h, Trickle Charge Disable	XC6808**D4**-G
L	4.40V	Hold Time 5h, Trickle Charge Enable	XC6808**E1**-G
M	4.40V	Hold Time 10h, Trickle Charge Enable	XC6808**E2**-G
N	4.40V	Hold Time 5h, Trickle Charge Disable	XC6808**E3**-G
P	4.40V	Hold Time 10h, Trickle Charge Disable	XC6808**E4**-G

④,⑤ represents production lot number

01 to 09, 0A to 0Z, 11 to 9Z, A1 to A9, AA to AZ, B1 to ZZ repeated
(G, I, J, O, Q, W excluded)

*No character inversion used.

1. The product and product specifications contained herein are subject to change without notice to improve performance characteristics. Consult us, or our representatives before use, to confirm that the information in this datasheet is up to date.
2. The information in this datasheet is intended to illustrate the operation and characteristics of our products. We neither make warranties or representations with respect to the accuracy or completeness of the information contained in this datasheet nor grant any license to any intellectual property rights of ours or any third party concerning with the information in this datasheet.
3. Applicable export control laws and regulations should be complied and the procedures required by such laws and regulations should also be followed, when the product or any information contained in this datasheet is exported.
4. The product is neither intended nor warranted for use in equipment of systems which require extremely high levels of quality and/or reliability and/or a malfunction or failure which may cause loss of human life, bodily injury, serious property damage including but not limited to devices or equipment used in 1) nuclear facilities, 2) aerospace industry, 3) medical facilities, 4) automobile industry and other transportation industry and 5) safety devices and safety equipment to control combustions and explosions. Do not use the product for the above use unless agreed by us in writing in advance.
5. Although we make continuous efforts to improve the quality and reliability of our products; nevertheless Semiconductors are likely to fail with a certain probability. So in order to prevent personal injury and/or property damage resulting from such failure, customers are required to incorporate adequate safety measures in their designs, such as system fail safes, redundancy and fire prevention features.
6. Our products are not designed to be Radiation-resistant.
7. Please use the product listed in this datasheet within the specified ranges.
8. We assume no responsibility for damage or loss due to abnormal use.
9. All rights reserved. No part of this datasheet may be copied or reproduced unless agreed by Torex Semiconductor Ltd in writing in advance.

TOREX SEMICONDUCTOR LTD.

Данный компонент на территории Российской Федерации

Вы можете приобрести в компании MosChip.

Для оперативного оформления запроса Вам необходимо перейти по данной ссылке:

<http://moschip.ru/get-element>

Вы можете разместить у нас заказ для любого Вашего проекта, будь то серийное производство или разработка единичного прибора.

В нашем ассортименте представлены ведущие мировые производители активных и пассивных электронных компонентов.

Нашей специализацией является поставка электронной компонентной базы двойного назначения, продукции таких производителей как XILINX, Intel (ex.ALTERA), Vicor, Microchip, Texas Instruments, Analog Devices, Mini-Circuits, Amphenol, Glenair.

Сотрудничество с глобальными дистрибьюторами электронных компонентов, предоставляет возможность заказывать и получать с международных складов практически любой перечень компонентов в оптимальные для Вас сроки.

На всех этапах разработки и производства наши партнеры могут получить квалифицированную поддержку опытных инженеров.

Система менеджмента качества компании отвечает требованиям в соответствии с ГОСТ Р ИСО 9001, ГОСТ РВ 0015-002 и ЭС РД 009

Офис по работе с юридическими лицами:

105318, г.Москва, ул.Щербаковская д.3, офис 1107, 1118, ДЦ «Щербаковский»

Телефон: +7 495 668-12-70 (многоканальный)

Факс: +7 495 668-12-70 (доб.304)

E-mail: info@moschip.ru

Skype отдела продаж:

moschip.ru

moschip.ru_4

moschip.ru_6

moschip.ru_9