

INTERFACE

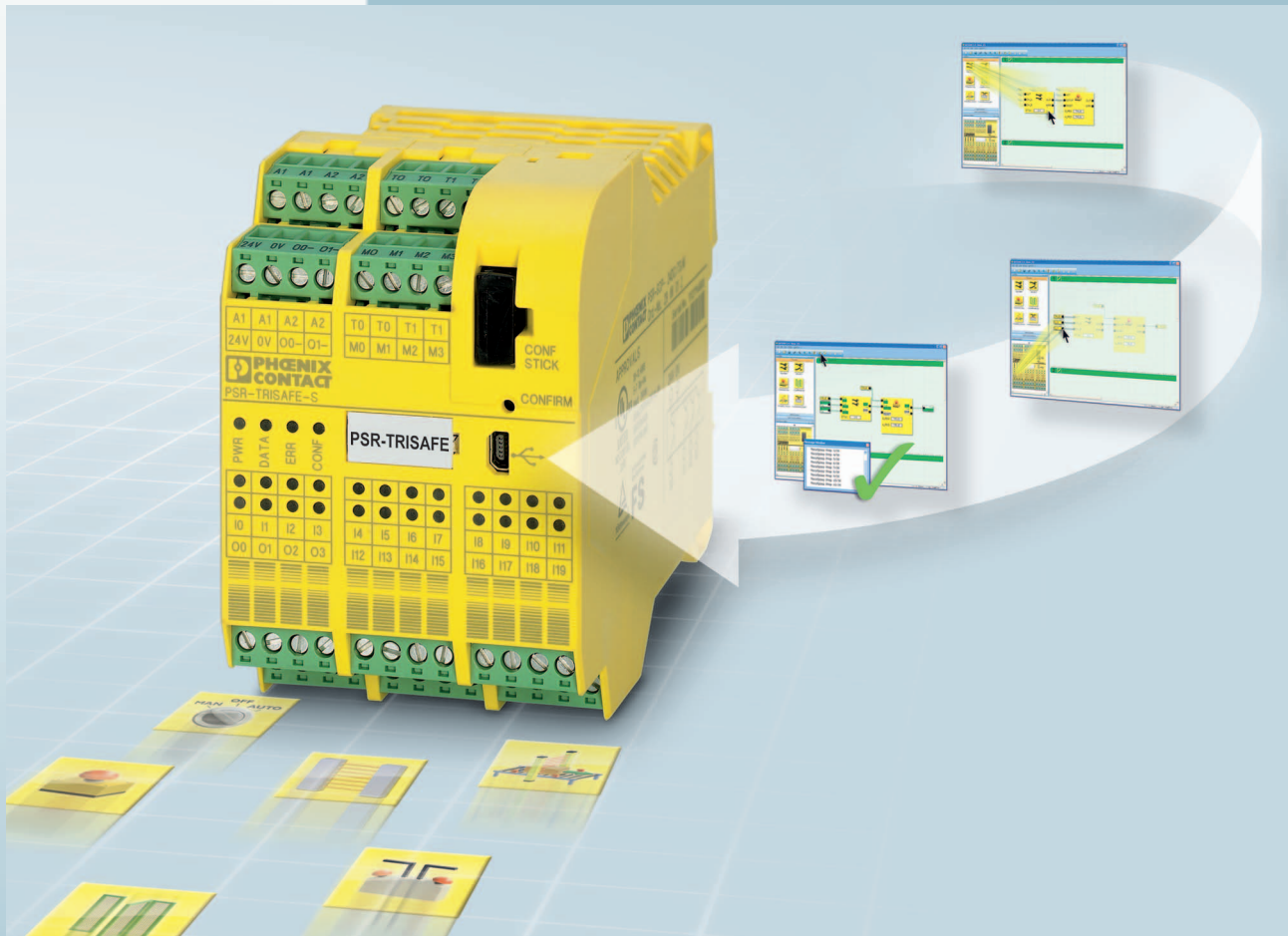

User Manual

UM EN PSR-TRISAFE-S

Order No. —

Device description, configuration, and startup of the PSR-TRISAFE-S safety module

INTERFACE

User Manual

Device description, configuration, and startup of the PSR-TRISAFE-S safety module

2011-06-22

Designation: UM EN PSR-TRISAFE-S

Revision: 03

Order No.: —

This user manual is valid for:

Designation	Order No.
PSR-TRISAFE-S	
PSR-SCP-24DC/TS/S	2986229
PSR-SPP-24DC/TS/S	2986232

Please observe the following notes

In order to ensure the safe use of the product described, you have to read and understand this manual. The following notes provide information on how to use this manual.

User group of this manual

The use of products described in this manual is oriented exclusively to

- qualified electricians or persons instructed by them, who are familiar with applicable standards and other regulations regarding electrical engineering and, in particular, the relevant safety concepts.
- qualified application programmers and software engineers, who are familiar with the safety concepts of automation technology and applicable standards.

Phoenix Contact accepts no liability for erroneous handling or damage to products from Phoenix Contact or third-party products resulting from disregard of information contained in this manual.

Explanation of symbols used and signal words



This is the safety alert symbol. It is used to alert you to potential personal injury hazards. Obey all safety messages that follow this symbol to avoid possible injury or death.



DANGER

This indicates a hazardous situation which, if not avoided, will result in death or serious injury.



WARNING

This indicates a hazardous situation which, if not avoided, could result in death or serious injury.



CAUTION

This indicates a hazardous situation which, if not avoided, could result in minor or moderate injury.

The following types of messages provide information about possible property damage and general information concerning proper operation and ease-of-use.



NOTE

This symbol and the accompanying text alerts the reader to a situation which may cause damage or malfunction to the device, either hardware or software, or surrounding property.



This symbol and the accompanying text provides additional information to the reader. It is also used as a reference to other sources of information (manuals, data sheets, literature) on the subject matter, product, etc.

General terms and conditions of use for technical documentation

Phoenix Contact reserves the right to alter, correct, and/or improve the technical documentation and the products described in the technical documentation at its own discretion and without giving prior notice, insofar as this is reasonable for the user. The same applies to any technical changes that serve the purpose of technical progress.

The receipt of technical documentation (in particular data sheets, installation instructions, manuals, etc.) does not constitute any further duty on the part of Phoenix Contact to furnish information on alterations to products and/or technical documentation. Any other agreement shall only apply if expressly confirmed in writing by Phoenix Contact. Please note that the supplied documentation is product-specific documentation only and that you are responsible for checking the suitability and intended use of the products in your specific application, in particular with regard to observing the applicable standards and regulations. Although Phoenix Contact makes every effort to ensure that the information content is accurate, up-to-date, and state-of-the-art, technical inaccuracies and/or printing errors in the information cannot be ruled out. Phoenix Contact does not offer any guarantees as to the reliability, accuracy or completeness of the information. All information made available in the technical data is supplied without any accompanying guarantee, whether expressly mentioned, implied or tacitly assumed. This information does not include any guarantees regarding quality, does not describe any fair marketable quality, and does not make any claims as to quality guarantees or guarantees regarding the suitability for a special purpose.

Phoenix Contact accepts no liability or responsibility for errors or omissions in the content of the technical documentation (in particular data sheets, installation instructions, manuals, etc.).

The aforementioned limitations of liability and exemptions from liability do not apply, in so far as liability must be assumed, e.g., according to product liability law, in cases of premeditation, gross negligence, on account of loss of life, physical injury or damage to health or on account of the violation of important contractual obligations. Claims for damages for the violation of important contractual obligations are, however, limited to contract-typical, predictable damages, provided there is no premeditation or gross negligence, or that liability is assumed on account of loss of life, physical injury or damage to health. This ruling does not imply a change in the burden of proof to the detriment of the user.

Statement of legal authority

This manual, including all illustrations contained herein, is copyright protected. Use of this manual by any third party is forbidden. Reproduction, translation, and public disclosure, as well as electronic and photographic archiving or alteration requires the express written consent of Phoenix Contact. Violators are liable for damages.

Phoenix Contact reserves all rights in the case of patent award or listing of a registered design, in as far as this concerns software of Phoenix Contact that meets the criteria of technicality or has technical relevance. Third-party products are always named without reference to patent rights. The existence of such rights shall not be excluded.

Windows 3.x, Windows 95, Windows 98, Windows NT, Windows 2000, Windows XP, and Windows Vista are trademarks of the Microsoft Corporation.

All other product names used are trademarks of the respective organizations.

How to contact us

Internet

Up-to-date information on Phoenix Contact products and our Terms and Conditions can be found on the Internet at:

www.phoenixcontact.com.

Make sure you always use the latest documentation.

It can be downloaded at:

www.phoenixcontact.net/catalog.

Subsidiaries

If there are any problems that cannot be solved using the documentation, please contact your Phoenix Contact subsidiary.

Subsidiary contact information is available at www.phoenixcontact.com.

Published by

PHOENIX CONTACT GmbH & Co. KG
Flachmarktstraße 8
32825 Blomberg
Germany
Phone +49 - (0) 52 35 - 3-00
Fax +49 - (0) 52 35 - 3-4 12 00

PHOENIX CONTACT
P.O. Box 4100
Harrisburg, PA 17111-0100
USA
Phone +1-717-944-1300

Should you have any suggestions or recommendations for improvement of the contents and layout of our manuals, please send your comments to

tecdoc@phoenixcontact.com.

Table of contents

1	For your safety	1-1
1.1	Purpose of this manual	1-1
1.2	General safety notes.....	1-1
1.3	Electrical safety	1-3
1.4	Safety of the machine or system.....	1-4
1.5	Directives and standards	1-5
1.6	Intended use.....	1-7
1.7	Documentation	1-8
2	System description	2-1
2.1	Method of operation and structure of the PSR-TRISAFE-S safety system	2-1
2.2	Using the system	2-4
2.3	System startup and restart behavior	2-5
2.4	Error detection in I/O devices	2-8
2.5	Diagnostic tools	2-9
2.6	Password protection	2-13
2.7	Ordering data	2-14
2.8	System requirements for the SAFECONF configuration software	2-15
3	Hardware: PSR-TRISAFE-S safety module	3-1
3.1	Device description.....	3-1
3.2	Operating modes (status) of PSR-TRISAFE-S	3-3
3.3	Operating and indication elements	3-4
3.3.1	Diagnostic and status indicators	3-4
3.3.2	"Confirm" button	3-6
3.4	Signal connections	3-7
3.4.1	Signal inputs	3-7
3.4.2	Safe outputs	3-8
3.4.3	Alarm outputs M0 to M3	3-9
3.4.4	Test pulse outputs T0 and T1	3-9
3.4.5	24 V/0 V supply connection	3-9
3.4.6	Supply connections A1 and A2	3-9
3.4.7	Ground switching outputs O0- and O1-	3-10
3.5	USB interface	3-11
3.6	IFS-CONFSTICK.....	3-12
3.7	Installing the safety module	3-13
3.7.1	Mounting the safety module	3-13
3.7.2	Connecting the supply voltage	3-16
3.7.3	Connecting the signal lines	3-17

4	SAFECONF configuration software	4-1
4.1	Installing SAFECONF	4-1
4.2	Overview of functions and features.....	4-1
4.3	Description of the user interface	4-3
4.4	Safe functional blocks and functions	4-5
4.5	Operating the SAFECONF configuration software	4-10
4.5.1	Creating the configuration project	4-10
4.5.2	Adding and connecting functions, functional blocks, and signals in the safety logic	4-11
4.5.3	Device parameterization in the safe parameter editor	4-15
4.5.4	Checking, downloading, and starting up the project	4-18
4.5.5	Documenting the signal assignment and the project	4-19
4.6	Simulation mode in SAFECONF.....	4-21
5	Configuration and startup	5-1
5.1	Configuration overview from A to Z.....	5-1
5.2	Downloading the configuration from SAFECONF.....	5-4
5.3	Downloading the configuration using the IFS-CONFSTICK.....	5-7
5.4	Uploading the configuration from the PSR-TRISAFE-S safety module	5-9
5.5	Function test.....	5-10
5.6	Startup mode.....	5-11
6	Application examples	6-1
7	Problems and solutions	7-1
7.1	General.....	7-1
7.2	Graphical connection editor.....	7-2
7.3	Device parameterization editor.....	7-2
7.4	Online communication between SAFECONF and the PSR-TRISAFE-S safety module	7-3
7.5	Safety module messages	7-5
A	Appendix	A-1
A.1	List of figures	A-1
A.2	Index.....	A-3

1 For your safety

1.1 Purpose of this manual

This manual should enable the user to set up, configure, and start up the PSR-TRISAFE-S configurable safety module according to the relevant safety requirements and the risk analysis performed.

The user manual is therefore designed as a complete system description, which provides an introductory system overview, then describes the PSR-TRISAFE-S configurable safety module and the associated SAFECONF configuration software in detail, and finally explains the necessary steps for configuration and startup.

For additional information and detailed step-by-step instructions for SAFECONF, please refer to the online help for the configuration software.

This user manual is oriented exclusively to qualified electrical engineers and safety specialists, application programmers, and software engineers, who are familiar with the relevant safety concepts of automation technology as well as applicable standards and other regulations. Please also read the "Qualified personnel" section in "General safety notes" on page 1-1.



The PSR-TRISAFE-S configurable safety module is referred to in this documentation as "safety module" for short.

1.2 General safety notes



WARNING: Personal injury and damage to equipment if these safety notes are not followed. When working with the PSR-TRISAFE-S safety module, please observe all the safety notes included in this section.

Requirements

Knowledge of the following is required:

- The PSR-TRISAFE-S safety module used and the I/O devices (extension units, sensors, actuators)
- The SAFECONF configuration software
- The safety directives for the field of application

Qualified personnel



WARNING: In the context of the use of the PSR-TRISAFE-S safety module with SAFECONF configuration software and safe functional blocks, the following operations may only be carried out by qualified personnel:

- **Planning, parameterization, configuration (development of safety logic)**
- **Installation, startup, servicing**
- **Maintenance, decommissioning**

This user manual is therefore aimed at:

- Qualified personnel who plan and design safety equipment for machines and systems and are familiar with regulations governing safety in the workplace and accident prevention.

- Qualified personnel who install and operate safety equipment in machines and systems.

Within the context of the safety notes in this documentation, qualified personnel are persons who, because of their education, experience and instruction, and their knowledge of relevant standards, regulations, accident prevention regulations, and service conditions, have been authorized to carry out any required operations, and who are able to recognize and avoid any possible dangers.

Documentation



You must observe all information in this documentation as well as in the documentation listed in "Documentation" on page 1-8.

Safety of personnel and equipment

The safety of personnel and equipment can only be assured if the safe functional blocks are used correctly (see "Intended use" on page 1-7).



NOTE: Please note that responsibility for fault avoidance lies with the user.

Error detection

Depending on the wiring and parameterization of the inputs and outputs, the PSR-TRISAFE-S safety module can detect various errors within the safety equipment (e.g., cross circuits).

Observe startup behavior

Some of the safe functional blocks in the SAFECONF configuration software have parameters for specifying a startup inhibit and/or a restart inhibit. An active startup inhibit/restart inhibit can be removed by pressing a reset button that is connected and appropriately wired to the safety module.

Use these parameters in the SAFECONF configuration software to monitor the startup/restart of the PSR-TRISAFE-S safety module.

Do not carry out any repairs, do not open the housing

In the event that an error caused by reconfiguring or modifying the wiring, etc. cannot be removed, please contact Phoenix Contact immediately.



WARNING: Repair work may not be carried out on the PSR-TRISAFE-S safety module. It is strictly prohibited to open the safety module housing.

1.3 Electrical safety

**DANGER: Hazardous body currents or the loss of functional safety.**

In order to ensure electrical safety, please observe the following points and the information in the user manuals for the devices used (e.g., sensors, actuators or extension units).

Direct/indirect contact

Protection against direct and indirect contact according to DIN VDE 0100-410 must be ensured for all components connected to the PSR-TRISAFE-S safety module. In the event of an error, parasitic voltages must not occur (single-fault tolerance).

Safe isolation

Only use devices with safe isolation if hazardous contact voltages can occur at their connections.

Power supply unit

Only use power supply units with safe isolation and PELV according to DIN EN 50178/VDE 0160 (PELV). This prevents short circuits between primary and secondary sides.

ESD**NOTE: Electrostatic discharge**

The device contains components that can be damaged or destroyed by electrostatic discharge. When handling the device, observe the necessary safety precautions against electrostatic discharge (ESD) according to EN 61340-5-1 and EN 61340-5-2.

1.4 Safety of the machine or system



WARNING: Ensure the safety of the machine or system.

The operator bears sole responsibility for the safety of the machine or system. The Machinery Directive must thus be observed.

Draw up and implement a safety concept

In order to use the system described in this document with the associated safe functional blocks, you must have drawn up an appropriate safety concept for your machine or system. This includes a hazard and risk analysis, as well as a test report for validating the safety functions.

The target safety integrity level (SIL according to DIN EN 61508 and category according to DIN EN ISO 13849-1) is ascertained on the basis of the risk analysis.

The safety integrity level or category ascertained determines:

- How safe sensors, control devices, and actuators should be wired within the overall safety function.
- How safe functional blocks should be used in the safety logic. (The safety logic is created using the SAFECONF configuration software.)

Within the safe control system used, the safe functional blocks support the following safety integrity requirements:

- Up to SIL 3 according to standard DIN EN 61508
- Up to SILCL 3 according to standard DIN EN 62061
- Up to category 4 according to standard DIN EN ISO 13849-1



Please note that you are responsible for implementing all additional requirements resulting from applicable directives and legislation in order to meet the above safety integrity requirements (see also "Directives and standards" on page 1-5).

Check hardware and device parameterization

Please note that you must carry out a validation every time you make a safety-related modification to your overall system. Use the relevant checklists when carrying out the validation and also enter the details requested in the "Project Information" dialog box in the SAFECONF safe configuration software.

Use your test report to ensure that:

- The safe sensors and actuators are connected correctly in the PSR-TRISAFE-S safety application. To do this, use the "Wiring check" function in SAFECONF (see page 2-11).
- The parameterization of the inputs and outputs of the PSR-TRISAFE-S safety module is correct.
- The signals have been connected to the safe sensors and actuators correctly (single-channel or two-channel).
- Cross-circuit detection is implemented in your application, if required (see page 2-8).
- All safe functional blocks and functions in the SAFECONF configuration software are connected correctly.

1.5 Directives and standards

The manufacturers and operators of machines and systems, in which the PSR-TRISAFE-S safety module is used, are responsible for adhering to all applicable directives and legislation.

Directives and standards considered in the development and implementation of the PSR-TRISAFE-S safety module:

Directives

- Machinery Directive 2006/42/EC
- Machinery Directive 98/38/EC
- EMC Directive 2004/108/EC
- Low Voltage Directive 2006/95/EC
- Guideline for test and certification GS-ET-26: Bus systems for the transmission of safety-related messages

Standards

Standard	Contents
DIN EN 61508-1:11.2002 DIN EN 61508-2:12.2002 DIN EN 61508-3:12.2002 DIN EN 61508-4:11.2002 DIN EN 61508-5:11.2002 DIN EN 61508-6:06.2003 DIN EN 61508-7:06.2003	Functional safety of electrical/electronic/programmable electronic safety-related systems
DIN EN ISO 13849-1	Safety of machinery - Safety-related parts of control systems; best suited for less complex systems. Part 1: General principles for design This standard was created on the basis of EN 954-1:1996, quality management and reliability aspects have been added.
DIN EN ISO 13849-2: 12.2003	Safety of machinery - Safety-related parts of control systems - Part 2: Validation
EN ISO 12100-2	Safety of machinery - Basic concepts, general principles for design Part 2: Technical principles
DIN EN 62061 IEC 62061	Safety of machinery - Functional safety of electrical, electronic and programmable control systems for machinery. Sector standard for machinery, created on the basis of IEC 61508. Safety for complex programmable systems. Proof of safety of devices as well as evaluation of risk reduction of the entire safety function through calculation.
DIN EN 60204-1:11.1998	Safety of machinery - Electrical equipment of machines - Part 1: General requirements

Standard	Contents
EN ISO 13850	Safety of machinery - Emergency stop, principles for design
DIN EN 61131-2:02.04	Programmable controllers - Part 2: Equipment requirements and tests
DIN EN 61131-3:02.04	Programmable controllers - Part 3: Programming languages
DIN EN 61496-1:06.98	Safety of machinery - Electrosensitive protective equipment - Part 1: General requirements and tests
DIN EN 1088	Safety of machinery - Interlocking devices associated with guards - Principles for design and selection
DIN EN 953	Safety of machinery - Guards - General requirements for the design and construction of fixed and movable guards
DIN EN 574	Safety of machinery - Two-hand control devices - Functional aspects - Principles for design
DIN EN 50254:07.1999	High efficiency communication subsystem for small data packages
EN 50178:04.1998	Electronic equipment for use in power installations
EC/ISO 7498	Information Technology; Open Systems Interconnection

1.6 Intended use



WARNING: Only use the PSR-TRISAFE-S safety module according to the information listed in this section.

PSR-TRISAFE-S

The PSR-TRISAFE-S safety module should only be used in industrial applications according to standards DIN EN 61508, DIN EN ISO 13849, and DIN EN 62061.

The PSR-TRISAFE-S safety module is designed for evaluating safety-related sensors on a machine or system, which are connected to the inputs of the safety module, and for controlling its outputs according to the configured safety logic.

The safety module can only perform its safety-related tasks if it has been integrated into the execution process correctly and in such a way as to avoid errors.

You must observe all information in this manual as well as in the user manuals and online help listed in "Documentation" on page 1-8. In particular, only use the PSR-TRISAFE-S safety module according to the technical data specified in "System requirements for the SAFECONF configuration software" on page 2-15.

SAFECONF

The SAFECONF safe configuration software is designed for the configuration of the PSR-TRISAFE-S safety module.

Safe functional blocks and functions in SAFECONF

The safe functional blocks and functions available in the SAFECONF configuration software for creating the safety logic are designed solely for use within the PSR-TRISAFE-S safety module and support specific safety functions.

The safe functional blocks/functions can only perform their safety-related tasks within the safe control system if they have been integrated into the execution process correctly and in such a way as to avoid errors.



You must observe all information in the online help for each functional block. Theoretical examples of the use of the safe functional blocks are described in "Application examples".

The area of responsibility of the block manufacturer in terms of the function of a safe functional block or a safe function ends at the user interface, which is generated by the inputs and outputs of the functional blocks/functions.

In order to fully execute a safety function, it is your responsibility to connect the inputs and outputs of the safe functional blocks/functions in the SAFECONF configuration software:

- To your safety network
- To the single-channel or two-channel sensors and actuators connected to the inputs and outputs of the safety module

In defining the safety integrity level or category for the overall safety function, you must take into consideration all components involved in the execution of this safety function (sensors, actuators, wiring, etc.).



WARNING: In order to use a safe functional block or a safe function according to the required safety integrity as defined by DIN EN 61508, DIN EN ISO 13849 or DIN EN 62061, you must take into consideration the entire path of the safety function (safety module, device parameterization, wiring, sensors, actuators, single-channel or two-channel operation, etc.) starting from the "functional block I/O" interface.

Validate the entire path on completion.

1.7 Documentation

Latest documentation

Make sure you always use the latest documentation. Find out from the manufacturer or their homepage on the Internet whether any changes or additions have been made to the documentation used.

When working on and with the PSR-TRISAFE-S safety module, you must always keep this documentation and other items of product documentation to hand and observe the information therein.

You must observe all information:

- In the technical description of the PSR-TRISAFE-S safety module
- In the user documentation for I/O devices (e.g., sensors/actuators, etc.) connected to the PSR-TRISAFE-S safety module and connected to safe functional blocks in the safety logic (SAFECONF configuration software)
- In the online help for the SAFECONF configuration software (see also Figure 1-1) and for each of the safe functional blocks
- In the documentation for the supplementary standard technology, if applicable

Calling online help

The diagram below illustrates the various options for opening the online help and searching for information via context-sensitive help or via the contents or index.

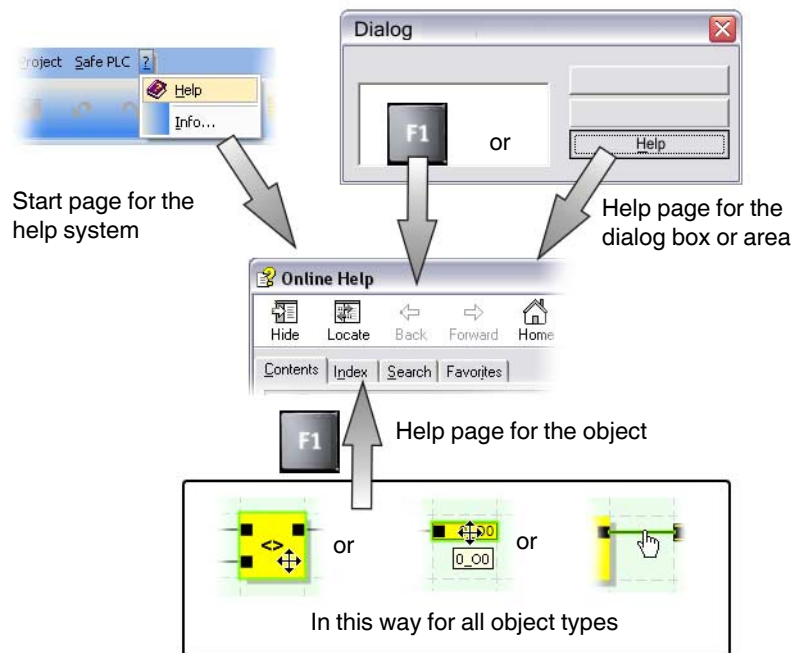

Figure 1-1 Calling the online help in the SAFECONF configuration software

2 System description

2.1 Method of operation and structure of the PSR-TRISAFE-S safety system

The overall system: Hardware and software

The PSR-TRISAFE-S safety system consists of the following components:

- PSR-TRISAFE-S safety module
- SAFECONF configuration software
- Suitable safe control devices, sensors, and actuators (depending on the application)

The PSR-TRISAFE-S safety module is designed for monitoring and evaluating safety-related control devices in machines and systems (see "Intended use" on page 1-7). The safety module monitors safe control devices and safety sensors connected at its inputs, evaluates the incoming signals according to its configuration, and controls the outputs accordingly.

The SAFECONF configuration software is used to configure the PSR-TRISAFE-S safety module and therefore provides the relevant editors as well as suitable startup and diagnostic tools.

The diagram below illustrates the overall system in an application example.

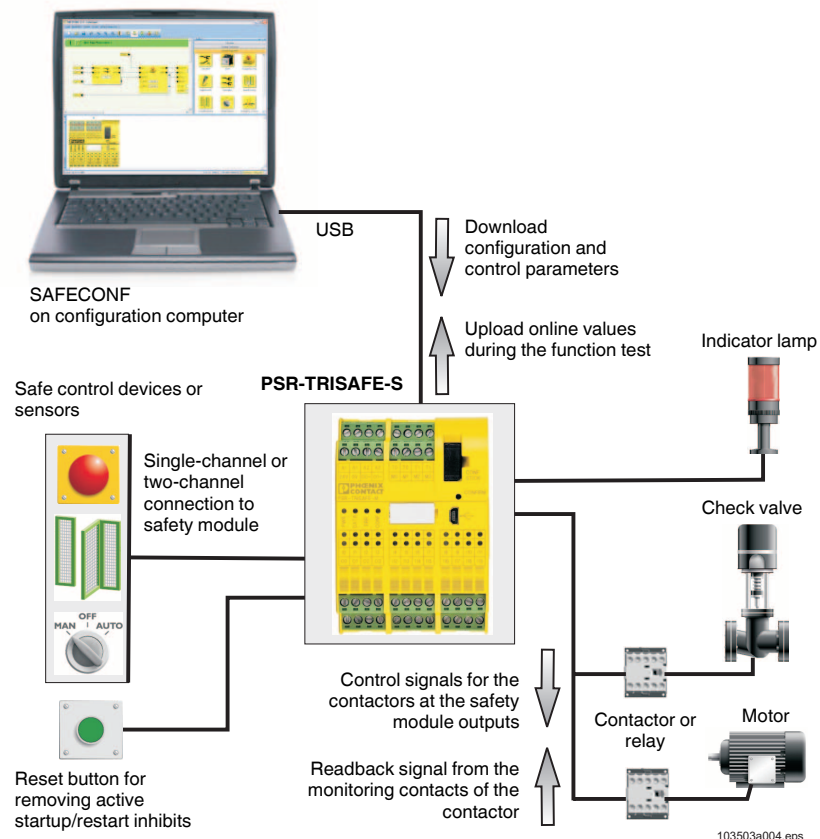

Figure 2-1 Typical structure of a safety system with PSR-TRISAFE-S

Hardware: PSR-TRISAFE-S

The PSR-TRISAFE-S safety module offers 20 digital safe inputs for connecting a maximum of 20 single-channel or 10 two-channel safety-related sensors and control devices.

The PSR-TRISAFE-S has 4 digital safe outputs, which are semiconductor outputs (24 V DC/2 A (total current)). The outputs are designed to meet up to category 4 according to EN 954-1.

Depending on the configuration, stop category 0 according to DIN EN 60204-1 can be achieved for each output (see "Stop category 0" on page 2-4).

In addition, four signaling current paths, two test pulses at two outputs each, and two ground switching outputs are available.

For more detailed information about the safety module, please refer to the device description in Section 3.

Software: SAFECONF

The PSR-TRISAFE-S safety module can only be configured and parameterized using the SAFECONF safe configuration software, which is executed on a separate Windows® PC.

The software offers a graphical connection editor for this purpose. The safety logic can be created here by graphically connecting prepared safe functions and functional blocks to the inputs and outputs of the safety module. The connections are made intuitively using the mouse, and the editor prevents impermissible connections (e.g., between certain outputs).

In addition, the software provides a safe parameter editor, which can be used to configure each input and output of the PSR-TRISAFE-S safety module.

A special online mode supports a detailed **function test** of the safety logic executed in the PSR-TRISAFE-S safety module. Current signal values can be read from the PSR-TRISAFE-S safety module, transmitted to the configuration software, and displayed there "live" in the connection editor.

For more detailed information about the configuration software, please refer to the software description in Section 4.

Secure communication

Communication between the PSR-TRISAFE-S safety module and the configuration software is via a USB interface.

A special security protocol enables secure data transmission via the USB interface.

There is communication between the two components in both directions:

- PC → safety module: The configuration data and device parameters are downloaded from the configuration PC to the safety module. Configuration data refers to the application logic, which was created using SAFECONF. The configuration can also be downloaded using the plug-in IFS-CONFSTICK. Please refer to "Downloading the configuration from SAFECONF" on page 5-4 and "Downloading the configuration using the IFS-CONFSTICK" on page 5-7.
- Safety module → PC: For diagnostic purposes, online values can be read from the PSR-TRISAFE-S safety module via the USB interface and displayed "live" in the software. For more detailed information, please refer to "Function test" on page 5-10.

Communication via the PSR TBUS DIN rail connector

The PSR-TRISAFE-S safety module is equipped with an interface for the PSR TBUS DIN rail connector. The PSR DIN rail connector from Phoenix Contact can be used to connect slave extension modules. Communication with these modules is then established automatically via the connector on the PSR DIN rail connector. Safety-related cross-wiring is not required (see also "Mounting the safety module" on page 3-13).

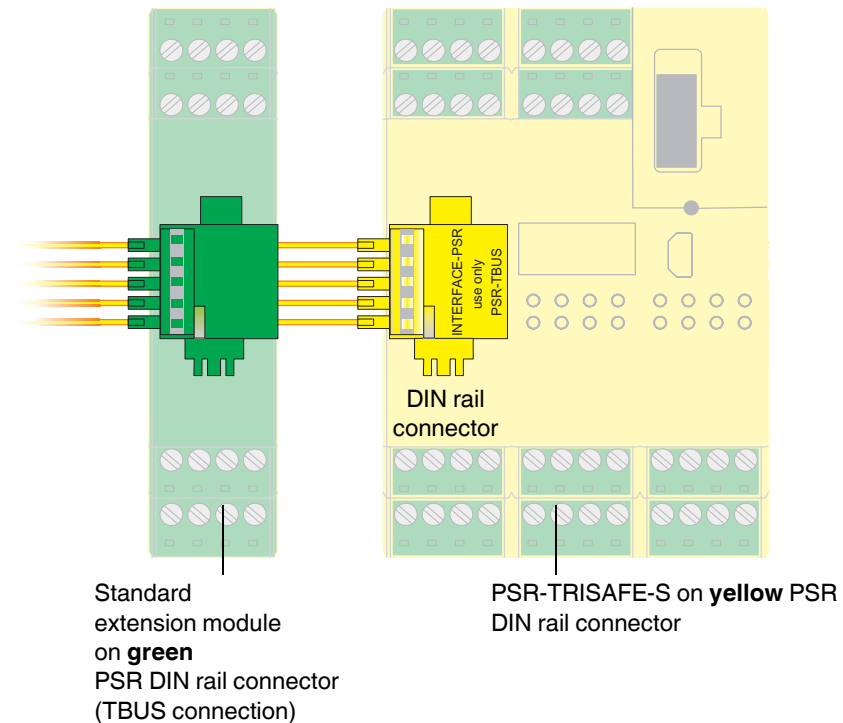

Figure 2-2 PSR TBUS DIN rail connector from Phoenix Contact



The maximum continuous current for extension modules supplied via the TBUS is 4 A.

2.2 Using the system

The PSR-TRISAFE-S safety module configured with SAFECONF is designed for monitoring and evaluating safety control devices and safety sensors in machines.

Machinery Directives and various standards and safety regulations require machine or system manufacturers to meet a high standard of safety.



The term "machine" is used here to represent any technical systems according to Machinery Directive 2006/42/EC.

Safety circuits

Safety control devices and safety sensors differ as follows:

Emergency stop control devices can only be detected in the event of dangerous operation and thus operate in the background. Safety door switches or light grids, for example, are often required for operational reasons and therefore regularly control the connection/disconnection of the safety-related part of the machine.

The PSR-TRISAFE-S safety module can be configured flexibly. For the creation of the safety logic, it has safe functional blocks, which are part of the system. The PSR-TRISAFE-S can be used to implement various safety functions in different safety circuits. Some of the most important options are:

- Emergency stop monitoring
- Safety door monitoring (with and without guard locking)
- Two-hand control devices (Types II and III)
- External device monitoring (feedback monitoring)
- Monitoring and checking electrosensitive protective equipment
- Mode selector switch (evaluation of a mode selector switch and an enable switch)
- Muting applications (light grid monitoring with parallel muting)

Stop category 0

Depending on the safety logic configured for the actual application, PSR-TRISAFE-S safety module outputs can be used to stop machines/drives with stop category 0 according to DIN EN 60204-1.

DIN EN 60204-1 defines stop category 0 as uncontrolled stopping by immediate removal of power to a machine.

Whether a safe output meets stop category 0 depends on the safe functional blocks connected in the safety logic: only if the module output is connected **directly** to the enable output of a safe functional block, which executes stop category 0 at its output, can the module output also meet this category.

Example

The EmergencyStop functional block executes stop category 0 at its enable output. If this block output is connected directly to a module output, the safety module also executes stop category 0 at this output.

Figure 2-3 on page 2-7 shows an example of this type of connection.

Equipment on the machine

The configuration and startup of the relevant safety circuit must be planned and verified precisely. Different machines are subject to different requirements for the implementation of a safety function.

Example: You are responsible for planning and implementing the startup behavior and the restart behavior according to your risk analysis. To prevent an unexpected startup, a reset button may be required to generate a manual reset signal at the machine. This will depend on both the results of the risk analysis and the signal path.

Additional safe control devices, such as three-position enable switches, etc., may be required.

2.3 System startup and restart behavior

Startup

"Startup" refers to the behavior of the PSR-TRISAFE-S safety module after switching on (or applying the supply voltage) and following configuration via USB interface or IFS-CONFSTICK.

Unless a startup inhibit is configured, the safety module starts up immediately following successful configuration (i.e., after pressing the "Confirm" button). The signal inputs are then evaluated and the outputs controlled accordingly.

Restart

"Restart" refers to the behavior of the safety module after the safety function is triggered and following a return to normal operation, for example, after unlocking the emergency stop control device, which means safe operation is possible again.

With an active startup/restart inhibit, the corresponding (inhibited) safe module output remains in the safe state. This prevents an undesired startup/restart of a machine controlled by the relevant output terminal block.



The **safe state** of an output terminal block is power off mode (signal value: FALSE).

Reset button

To enable the function of the machine, which is controlled by the PSR-TRISAFE-S output affected by the active startup inhibit/restart inhibit, the inhibit must be removed by a reset signal.

As in the case of the stop category (see page 2-4), the startup and restart behavior of the safety module depends on a specific output, and how this output is connected in the configured safety logic.

The reset signal is used at the same time to exit the error state once the error cause has been removed.

Implementation using safe functional blocks

To implement a startup inhibit/restart inhibit, safe functional blocks must be used in the SAFECNF configuration software, which have the relevant parameters for activating the startup inhibit and/or restart inhibit.

The table below lists the functional blocks that offer these parameters.

Table 2-1 Functional blocks that support a startup inhibit/restart inhibit

Functional block name	Function	Available inhibit
EmergencyStop	Emergency stop monitoring	Startup inhibit Restart inhibit
EDM	External device monitoring	Startup inhibit
EnableSwitch	Evaluation of a three-position enable switch	Restart inhibit
ESPE	Monitoring of electrosensitive protective equipment (e.g., light grid)	Startup inhibit Restart inhibit
GuardLocking	Monitoring of safety door with four-state interlocking	Startup inhibit Restart inhibit
GuardMonitoring	Monitoring of safety door with two-state interlocking	Startup inhibit Restart inhibit
MutingPar_2Sensor	Monitoring of two muting sensors and light grid	Startup inhibit
TestableSafetySensor	Monitoring of a connected optoelectronic protective device (e.g., light curtain) with test function	Startup inhibit Restart inhibit

To configure a startup inhibit for a specific safe output, for example, this output must be **directly** connected in the safety logic to the output of a safe functional block, for which the startup inhibit is set via the parameters.

Example

In the example below, EmergencyStop as well as a startup inhibit (S_RES parameter = FALSE) and a restart inhibit (A_RES = FALSE) are specified for the safe functional block. The OUT enable output for the functional block is connected directly to safe output O0, where O0 offers a restart inhibit and a startup inhibit. (EmergencyStop executes stop category 0 at the output, which is also transmitted to O0 by the direct connection.)

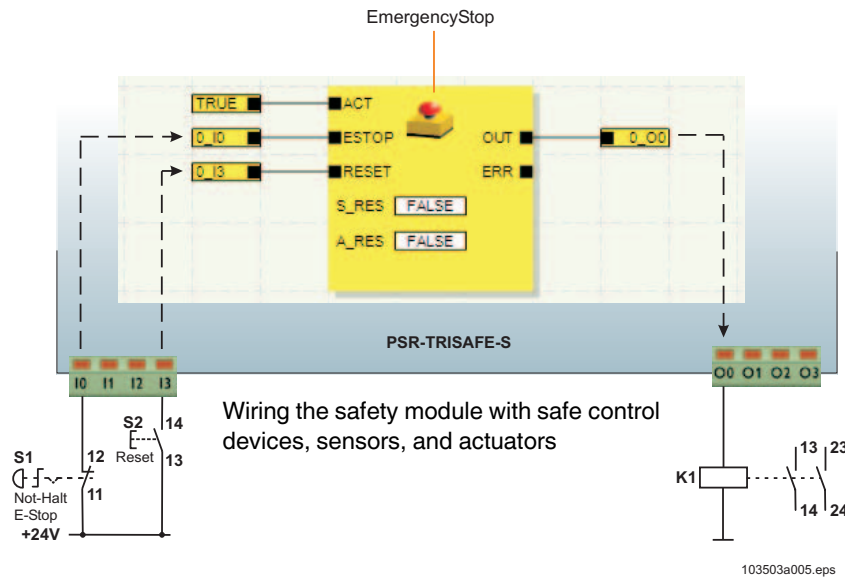

Figure 2-3 Implementing a startup inhibit, restart inhibit, and stop category 0 for safe output O0

2.4 Error detection in I/O devices

Cross-circuit detection

Cross circuits of the connected signal lines can be detected at the safe inputs.

A cross circuit is an unintentional, incorrect connection between redundant circuits.

Clock outputs T0 and T1

The safety module provides clock outputs T0 and T1 as an aid for detecting such a cross circuit. The test pulses output here are asynchronous.

For example, if two differently clocked signals are routed back to two inputs of the safety module along two channels via an emergency stop control device, a cross circuit can be reliably detected in this emergency stop circuit. In the event of a cross circuit, the same clock signal would be present at both inputs, instead of two different ones.



SAFECONF configuration software specifies the clock signals to be used: for all "even" inputs (I0, I2, I4, ..., I18), cross-circuit detection is implemented with test pulse T0. For "odd" inputs (I1, I3, I5, ... I19), test pulse T1 must be used for cross-circuit detection.

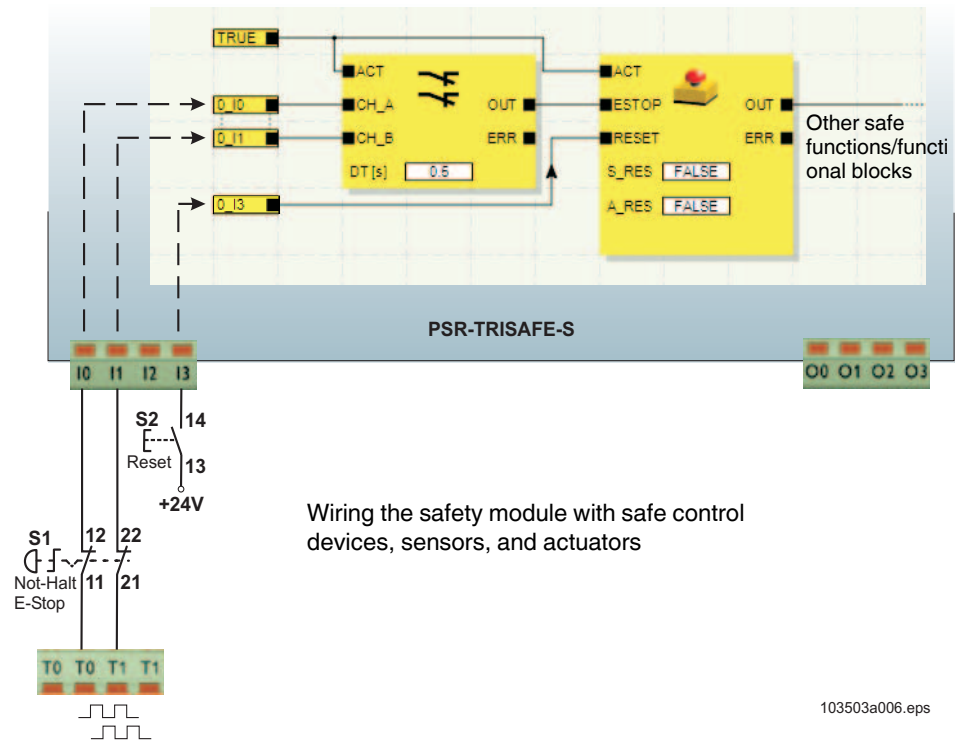

Figure 2-4 Implementing cross-circuit detection for an emergency stop control device at inputs I0 and I1 of the safety module

Parameter editor in SAFECONF

For this purpose, cross-circuit detection for the safety module inputs to be monitored must be activated in the SAFECONF configuration software in the device parameterization editor of the hardware editor.

Activating cross-circuit detection for the safety module inputs:

1. Open the parameter editor by double-clicking in the SAFECONF hardware editor.
2. Select the corresponding input.
3. In the selection box for this input, set "cross-circuit detection", as shown in the image below for inputs 0 and 1.

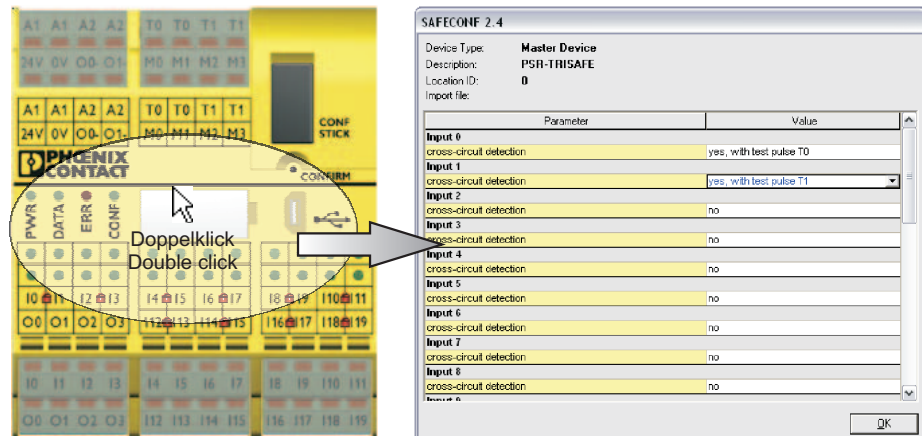

103503a016.eps

Figure 2-5 Parameterizing cross-circuit detection for a module input

2.5 Diagnostic tools



For an overview of the diagnostic and status indicators, please refer to Table 3-1 on page 3-5.

The SAFECONF configuration software and the PSR-TRISAFE-S safety module provide various tools that can be used to diagnose the active configuration on the safety module:

- Hardware diagnostics in the event of a safe functional block error
- Wiring check
- Status indicators on the safety module
- Online tool tips in the connection editor

Hardware diagnostics in the event of a safe functional block error

If a safe functional block detects an error, it sets its ERR error output to TRUE and the OUT enable output to the safe status FALSE.

For additional information, refer to the descriptions of the safe functional blocks in the SAFECONF online help, particularly in the corresponding "ERR output" help topic.

If the ERR output of a safe functional block is TRUE, all the inputs that are connected **directly** to the inputs of this functional block flash on the safety module.

This makes it easy to see which input of the safety module has been affected by the problem and further measures can be taken to remove the fault (check the connecting cables to the sensors or the connected sensors themselves, etc.).



This function enables hardware errors to be located even without a PC (configuration software), as the error is also visualized on the hardware thanks to the flashing LED(s) at the safety module inputs. The project documentation also enables conclusions to be drawn regarding the relevant safe functional block (i.e., the one reporting the error) using the flashing module input, without a PC being connected.

The following **example** shows a simplified schematic view: An emergency stop control device with two N/C contacts is connected to inputs I0 and I1 of the safety module. The status of the N/C contacts is monitored by the Equivalent safe functional block at the start of the safety logic. In our example, the functional block reports an error (ERR output = TRUE, the symbol for the functional block is surrounded by a red border with the configuration software in online mode).

Therefore, the LEDs for inputs I0 and I1, which are both directly connected to this functional block, flash on the safety module.

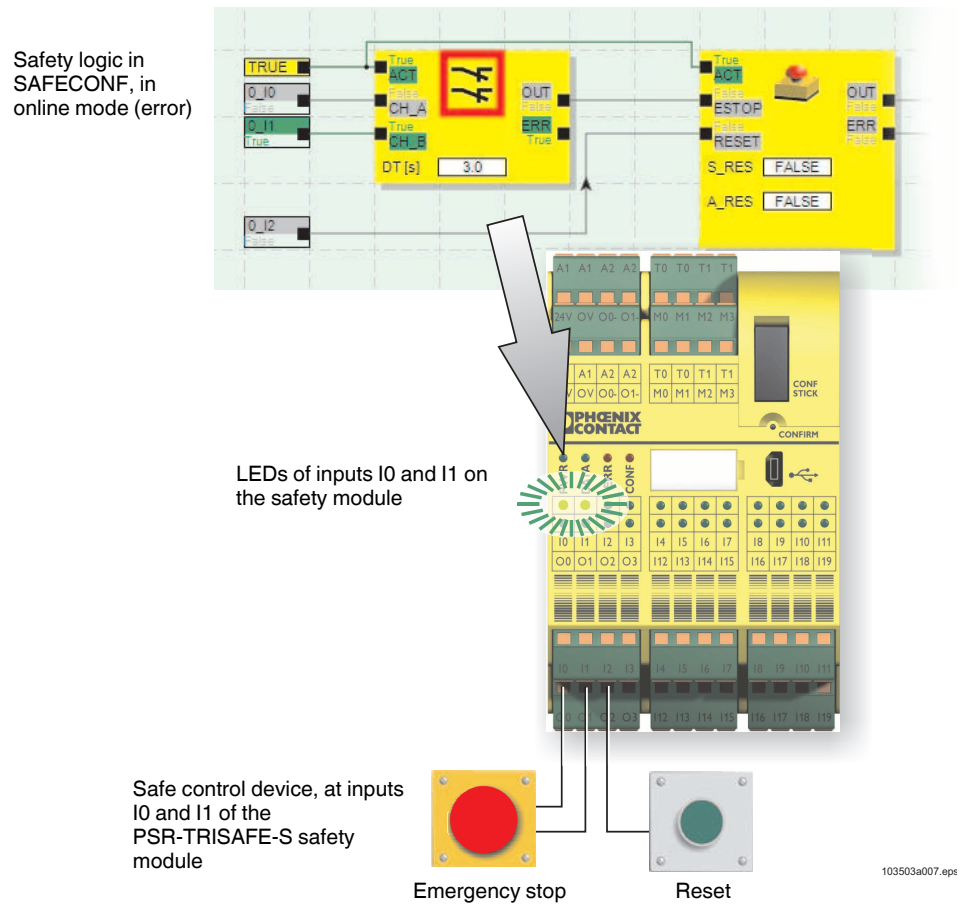

Figure 2-6 Simplified schematic view: Hardware diagnostics in the event of an error at a safe functional block

Wiring check

If the connection editor is in startup mode, the wiring check can be used to easily check the terminal block position of the input used in the logic. A graphical link directs the user to the right position and provides a better overview of the control cabinet.

1. **Requirement:** The PSR-TRISAFE-S safety module must be running.
Switch the connection editor to online mode, then to startup mode.
2. In the connection editor, position the cursor over the symbol for the input or output you want to check, **without** clicking. The symbol starts to flash after around one second. At the same time, the LED for the corresponding I/O also starts to flash on the PSR-TRISAFE-S safety module.

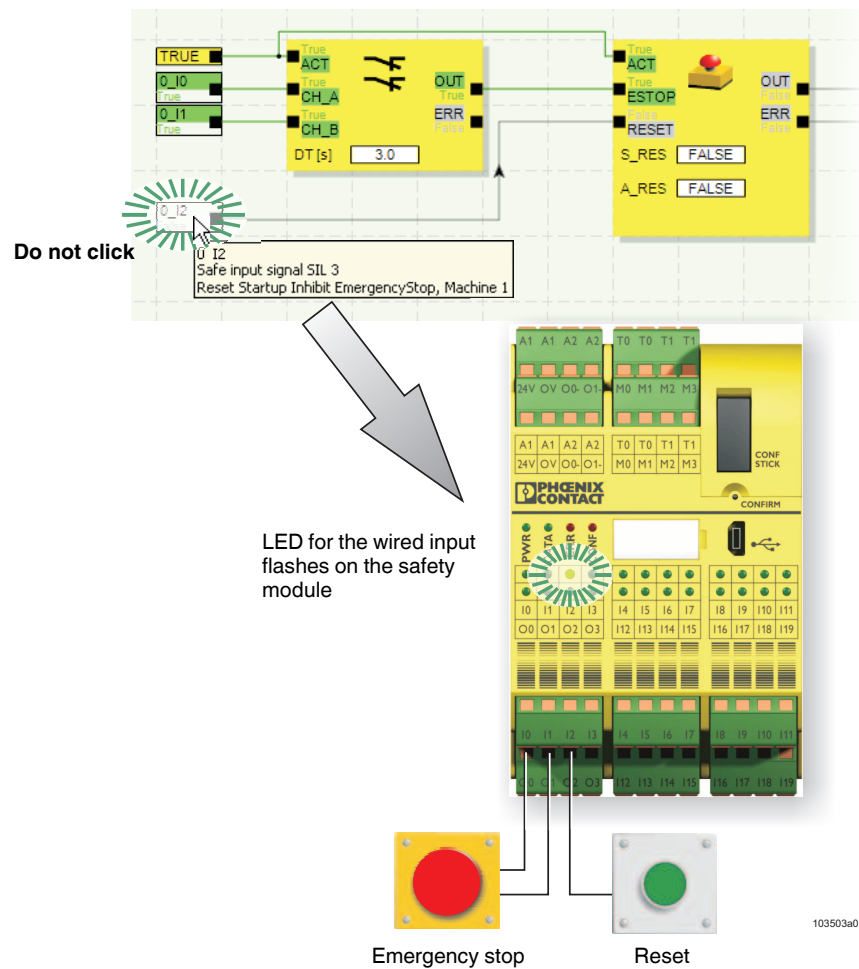

Figure 2-7 Simplified schematic view: Wiring check

Status indicators on the PSR-TRISAFE-S safety module

There are four LEDs on the PSR-TRISAFE-S safety module.

- PWR (green): Indicator for the power supply of the safety module
- DATA (green): Indicator for communication with extension devices (with/without TBUS)
- ERR (red): Error display
- CONF (green): Indicator for the configuration status and communication via the USB interface

The LEDs indicate the status of the safety module.



For a detailed list of possible indicator combinations and their meanings, please refer to "Diagnostic and status indicators" on page 3-4.

Online tool tips in the connection editor

In online mode, when the SAFECONF configuration software reads signal values from the PSR-TRISAFE-S safety module and displays them "live" in the connection editor, the safe functional blocks indicate their status and, in the event of an error, a description of the error as a tool tip as soon as you position the cursor over the symbol for a functional block.

In the event of an error, the tool tip contains not only a description of the error, but also information on how to remove it. In the event of an error, the functional block symbol is also outlined in red. This ensures that, in online mode, errors can be identified at a glance.

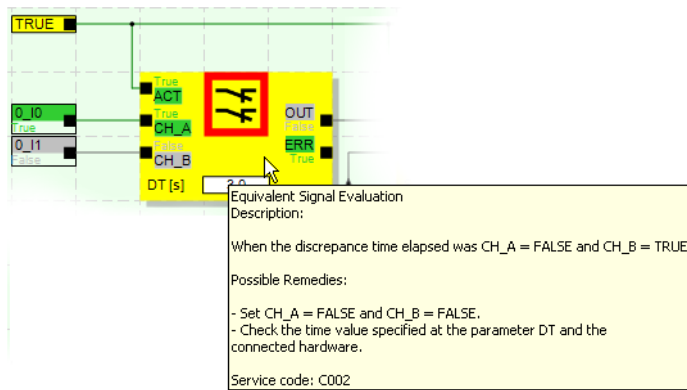

Figure 2-8 Example of an online tool tip in the event of an error

Offline tool tips

Tool tips are also available while editing the safety logic in the connection editor. For all functional blocks, functions, and their I/Os as well as for the buttons in the toolbar, descriptions are displayed as soon as the cursor is positioned over the item.



Figure 2-9 Examples of tool tips in the connection editor in offline mode (while editing the safety logic)

2.6 Password protection

The PSR-TRISAFE-S and SAFECONF use two passwords to offer dual protection against unauthorized modifications to the configuration and the project in the configuration software.



Figure 2-10 Password protection for the PSR-TRISAFE-S and SAFECONF

Controller password

The controller password protects the configuration on the PSR-TRISAFE-S safety module against unauthorized access and the safety module itself against unauthorized modification of the operating mode. However, online values can be read from the safety module and displayed in SAFECONF without entering the controller password. However, a new configuration or new device parameters can only be downloaded to the safety module (and the safety module can only be launched accordingly) once the controller password has been entered.



When an unconfigured PSR-TRISAFE-S safety module is connected to the configuration computer for the first time, SAFECONF automatically prompts the user to specify a controller password. This password can be modified later if required.

Project password

The project password protects the configuration project in SAFECONF against unauthorized modifications to the safety logic and the project information. You can still open and display projects without a password, but you can only change and save them once you have entered a project password. This ensures that only authorized persons in possession of the correct project password can change the safety logic.



When creating a new project, you will be automatically requested to define a password.

Automatic logoff due to a long period of inactivity in SAFECONF

If no user activity is detected in SAFECONF for a certain period of time, you will be logged off from the project automatically. This prevents unauthorized persons from making changes to the project if you have not logged off from the project.

For the PSR-TRISAFE-S safety module: after a long period of inactivity, you must enter the controller password again in order to communicate with the safety module in SAFECONF.

During automatic logoff, for safety reasons the safety module remains in the mode that was running prior to automatic logoff.

Example: The automatic logoff does not cause startup mode to be exited, but you must log on again before you will be able to influence signals once more.



For additional information about password protection, please refer to the online help for SAFECONF.

2.7 Ordering data

Description	Type	Order No.	Pcs./Pkt
Configurable safety module.			
Module with screw connections	PSR-SCP-24DC/TS/S	2986229	1
Module with spring-cage connections	PSR-SPP-24DC/TS/S	2986232	1
PSR configuration package including SAFECONF configuration software, configuration cable (USB), and Quick Start Guide			
German	PSR-SAFECONF-BOX-DE	2986151	
English	PSR-SAFECONF-BOX-EN	2986164	
Memory module for the PSR-TRISAFE-S (supplied as standard with the safety module).	IFS-CONFSTICK	2986122	1
USB to mini-USB connecting cable for PSR-TRISAFE-S.	CABLE-USB/MINI-USB-3.0M	2986135	1

2.8 System requirements for the SAFECNF configuration software

Under Windows Vista	Minimum	Recommended
CPU	1 GHz x86 architecture	2 GHz x86 architecture
Main memory	1 GB	2 GB

Under Windows XP/2000 (SP4/SP2)	Minimum	Recommended
CPU	1 GHz x86 architecture	1 GHz x86 architecture
Main memory	512 MB	1 GB

All operating systems	Minimum	Recommended
Hard disk	1 GB free memory space	1 GB free memory space
Monitor/resolution	SVGA/800 x 600	SVGA/800 x 600
Mouse	Required	Required
CD-ROM drive	Required	Required
USB interface	Required	Required
Internet Explorer 5.5 or later	Required	Required

3 Hardware: PSR-TRISAFE-S safety module

3.1 Device description

The PSR-TRISAFE-S safety module is a configurable safety controller with 20 digital safe inputs, which enable the connection of a maximum of 20 single-channel or 10 two-channel safe sensors or control devices.

The four digital safe outputs, O0 to O3, are controlled after evaluating the incoming signals according to the configuration, which was created with the SAFECONF configuration software and downloaded to the PSR-TRISAFE-S safety module via USB interface.

The PSR-TRISAFE-S safety module also has two ground switching outputs, O0- and O1-, which can be used for example to switch off a contactor connected to the safety module either via the output or via ground. Use of the ground switching outputs increases the shutdown protection and cross-circuit protection of the safety circuit.

In addition, the safety module has four non-safety-related digital alarm outputs (M0 to M3), which can be used for example to control a standard PLC or signaling units.

The two asynchronous test pulses at T0 and T1 provide safe cross-circuit detection at the inputs of the safety module, as described in "Error detection in I/O devices" on page 2-8.

All connection terminal blocks are plug-in. The individual terminal block bases are mechanically keyed to prevent incorrect connection. The PSR-TRISAFE-S safety module is available either with screw connections (on the left in Figure 3-1) or with spring-cage connections (on the right in Figure 3-1).

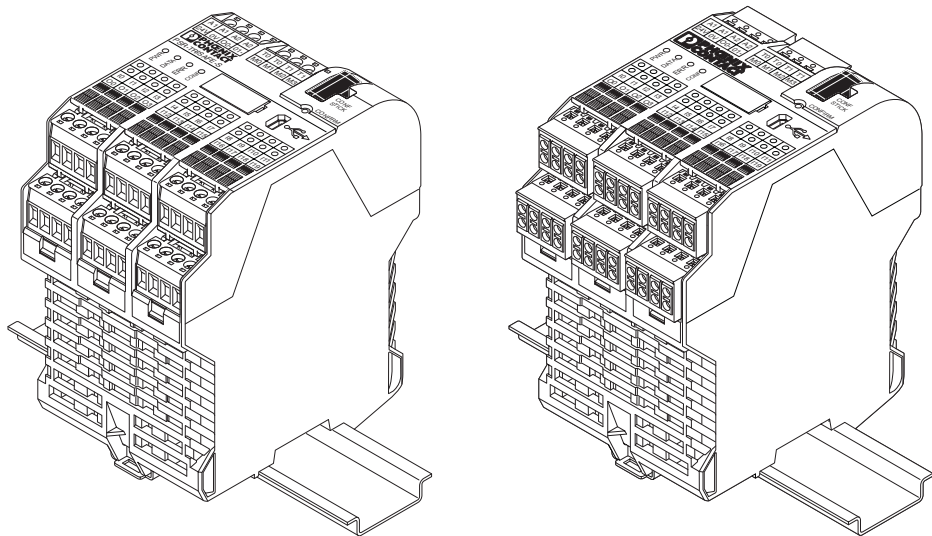

Figure 3-1 PSR-TRISAFE-S safety module with screw connection (left) or with spring-cage terminal blocks (right), on 35 mm EN DIN rail

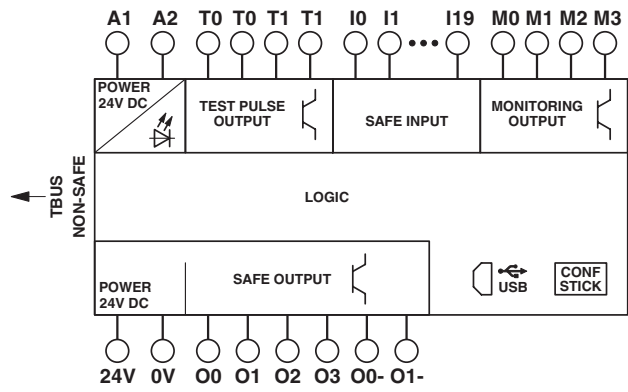

Figure 3-2 Block diagram for the PSR-TRISAFE-S safety module

3.2 Operating modes (status) of PSR-TRISAFE-S

The diagram below illustrates the possible operating modes (status) of the PSR-TRISAFE-S safety module and the possible status transitions. When there is a USB connection to the PC, the module status is indicated on the far left in the status bar of the SAFECONF configuration software.

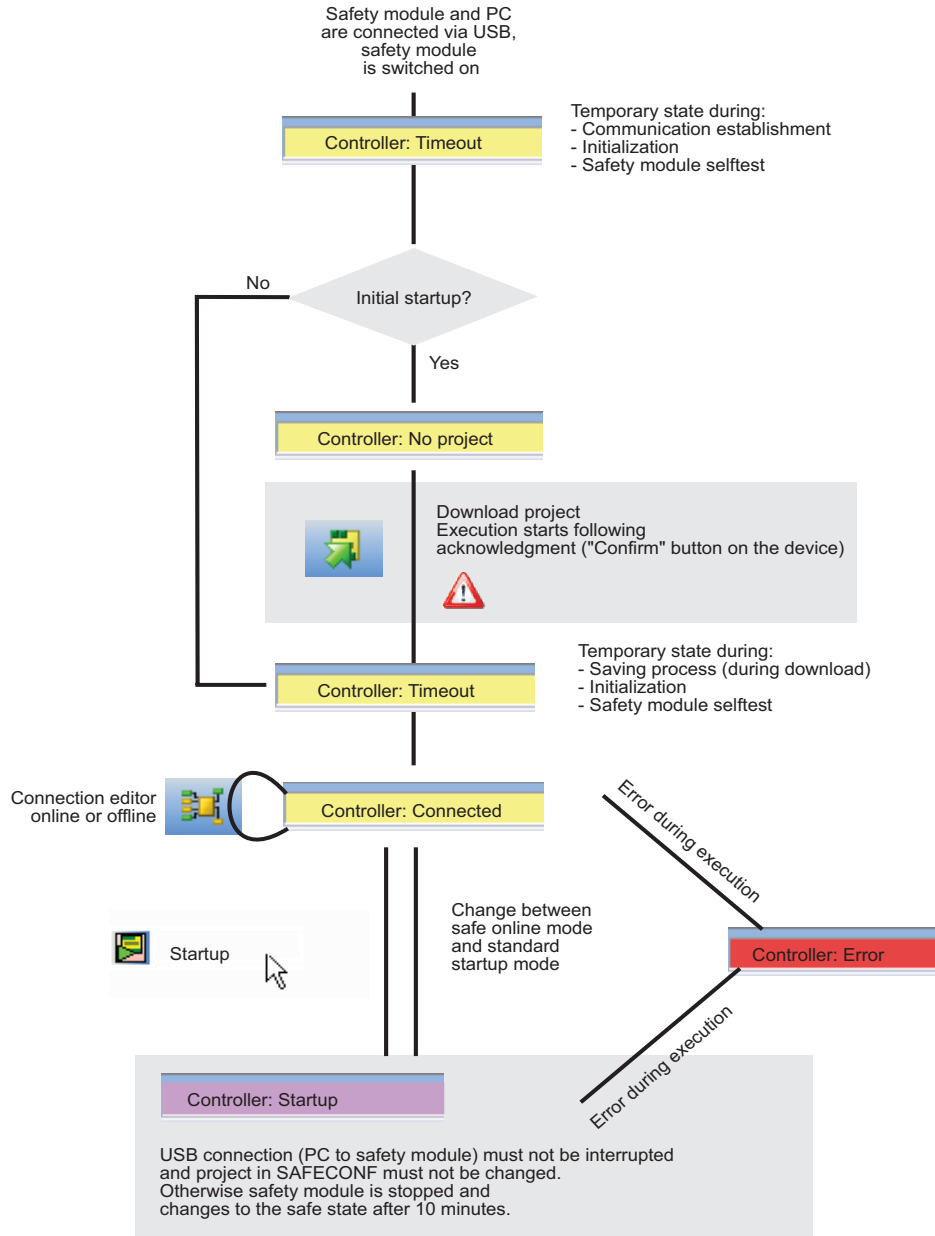

Figure 3-3 Diagram: Possible operating modes (status) for the PSR-TRISAFE-S safety module

3.3 Operating and indication elements

All operating and indication elements for the PSR-TRISAFE-S safety module are located on the front of the device. The elements are described in the following sections.

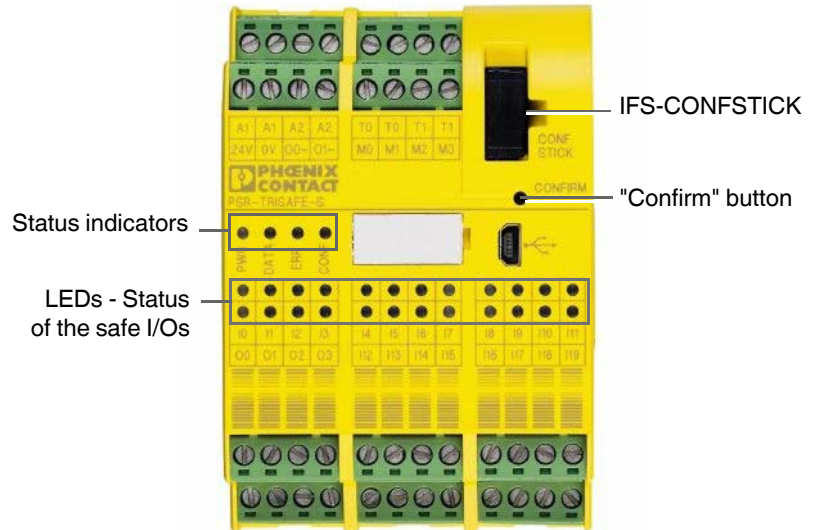

Figure 3-4 Operating and indication elements of the PSR-TRISAFE-S safety module

3.3.1 Diagnostic and status indicators

Status indicators

The four status indicators on the front of the device can be used to read the operating status of the safety module. The following LEDs are available (from left to right):

- "PWR": Indicator for the power supply of the safety module
- "DATA": Indicator for communication with extension devices (with/without PSR TBUS DIN rail connector). This LED is only on if a TBUS device is connected.
- "ERR": Error indicator
- "CONF": Indicator for the configuration status and communication via the USB interface

The following table lists the possible indicator combinations for the status LEDs and their meanings. A distinction is made between slow flashing and fast flashing LEDs.

The LED symbols in the table mean:

















































- LED OFF 
- LED ON 
- LED flashing
Slowly = 1.7 Hz 
Fast = 6.3 Hz

Table 3-1 Meaning of the status LEDs

PWR (green)	DATA (green)	ERR (red)	CONF (green)	Meaning
				Device is switched off, no power supply at A1/A2
				Initialization phase after power up
			 1.7 Hz	Acknowledgment of new configuration required after download. → Press the "Confirm" button on the device.
			 6.3 Hz	Acknowledgment of a new IFS CONFSTICK (program transmission via IFS CONFSTICK)
			 1.7 Hz	Extension unit replaced: acknowledgment required. → Press the "Confirm" button on the device.
				Normal operation without connected extension units (TBUS communication)
				Normal operation with connected extension units (TBUS communication)
	 			Limited operation with error for at least one I/O. → Remove error, deactivate I/O. Press the "Confirm" button on the device to reset the error message.
				No configuration data on the IFS-CONFSTICK. → Download project with SAFECONF.
				No IFS-CONFSTICK. → Insert IFS-CONFSTICK and apply power supply.
		 6.3 Hz		An error has occurred. → Read out the error code with SAFECONF.

LEDs for signal I/Os

The state of each of the 20 safe inputs and 4 safe outputs is indicated by an LED on the front of the device.

Table 3-2 Operating LEDs for the safe inputs and outputs

LED	State	Meaning
For each input ("I0" to "I19")	●	No switching signal at the relevant input
	☀	Switching signal active at the input
	☀/●	The diagnostics routine of the device has discovered an error on the corresponding input. Possible causes are incorrect wiring of the input or (from the perspective of the secure functional block connected to this input) incorrect switching signals. Note the diagnostic tools described in section 2.5 starting on page 2-9.
For each output ("O0" to "O3")	●	Output inactive
	☀	Output active
	☀/●	The diagnostics routine of the device has discovered an error on the corresponding output. Possible causes are feedback of +24 V DC, a cross circuit or overload.

3.3.2 "Confirm" button

Confirming the new configuration

The "Confirm" button is on the right-hand side on the front of the PSR-TRISAFE-S safety module, above the USB interface. Press this button using a pen to confirm a new configuration downloaded via the USB interface before it is accepted by the safety module. See also "Downloading the configuration from SAFECNF" on page 5-4.

Replacing the IFS-CONFSTICK

The "Confirm" button also plays an important role when replacing the IFS-CONFSTICK. To download a new configuration by replacing the IFS-CONFSTICK rather than via the USB interface, press and hold down the "Confirm" button while removing and inserting the IFS-CONFSTICK using the specified procedure.

For the precise procedure, please refer to "Downloading the configuration using the IFS-CONFSTICK" on page 5-7.

3.4 Signal connections

All input and output connections, with the exception of the USB interface, are made via plug-in keyed connection terminal blocks.

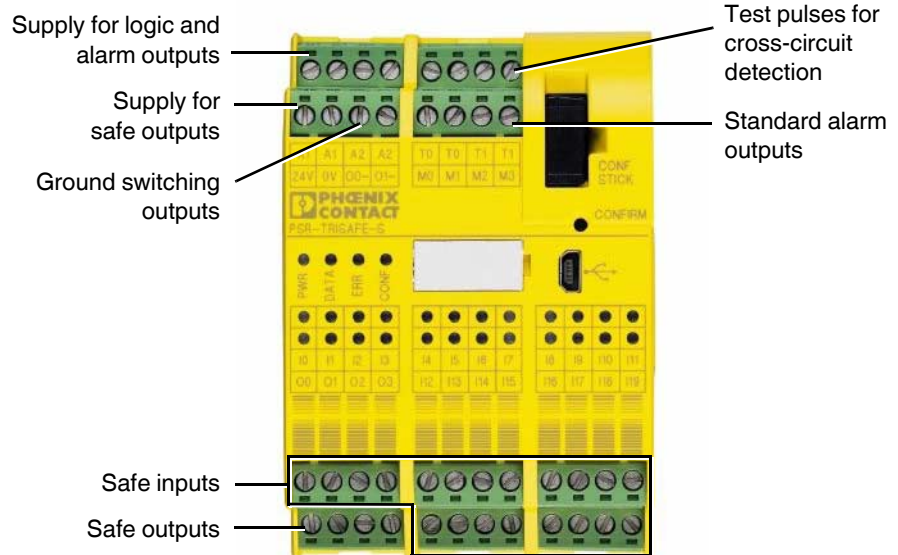

Figure 3-5 PSR-TRISAFE-S signal connections

The various signal connections are described in the following sections.

3.4.1 Signal inputs

The PSR-TRISAFE-S safety module has 20 digital signal inputs (24 V HTL/3 mA) for the direct connection of safe control devices and/or safety sensors for monitoring and evaluating processes.

The safe inputs are linked to the safety logic in the connection editor of the SAFECONF configuration software. See also "Adding and connecting functions, functional blocks, and signals in the safety logic" on page 4-11.

Signal redundancy due to dual signals

Every two adjacent signal inputs (i.e., I0 and I1, I2 and I3, etc.) are grouped together and locked by default to form a dual signal in the SAFECONF configuration software. This is indicated in the representation of the safety module in the hardware editor of the configuration software by a red padlock at the relevant inputs. The two signals are then always used as a pair, i.e., both signals are dragged, dropped, cut or deleted together in the connection editor.

However, if required this lock can be removed and the dual signal split into two single signals.



Dual signals are not connected to one another internally; they are simply grouped together.

As input signals with even and odd IDs are processed in different ways in the safety module, using dual signals ensures that the safety module will perform redundant processing.

Two-channel sensors

To ensure signal redundancy, the prepared dual signal must be used to process two-channel signals (2-wire sensors and control devices). For example, in order to monitor or evaluate both signals of an emergency stop control device redundantly and to performance level PL e according to DIN EN ISO 13849-1 or EN 954-1 category 4, these two adjacent signal inputs (e.g., I0 and I1) must be connected.

Cross-circuit detection

A "cross circuit" is an unintentional, incorrect connection between redundant circuits. The PSR-TRISAFE-S safety module provides clock outputs T0 and T1 as an aid for detecting such a cross circuit.

For example, if two differently clocked signals are routed back to two inputs of the safety module along two channels via an emergency stop control device, a cross circuit can definitely be detected in this emergency stop circuit: In the event of a cross circuit, the same clock signal would be present at both inputs, instead of two different ones.

The SAFECONF configuration software specifies the clock signals to be used: Cross-circuit detection is implemented with test pulse T0 for "even" inputs (I0, I2, I4, ... I18). For "odd" inputs (I1, I3, I5, ... I19), test pulse T1 must be used for cross-circuit detection.



For an example of two-channel connection of an emergency stop control device with **dual signal and cross-circuit detection**, please refer to Figure 2-4 in "Error detection in I/O devices" on page 2-8.

3.4.2 Safe outputs

The safety-related outputs O0 to O3 are designed as digital semiconductor outputs for 24 V DC/2 A (total current), up to category 4 according to EN 954-1.

The outputs are controlled according to the configured safety logic. The safe outputs are linked to the safety logic that is used to control the outputs in the connection editor of the SAFECONF configuration software. See also "Adding and connecting functions, functional blocks, and signals in the safety logic" on page 4-11.



To increase cross-circuit protection, outputs O0 and O1 can also be used in connection with ground switching outputs O0- and O1-, see "Ground switching outputs O0- and O1-" on page 3-10.



An appropriate protective circuit (diode or varistor) for safe outputs O0 to O3 is strongly recommended.



The safe output signals are clocked with a test pulse of 1 ms.

3.4.3 Alarm outputs M0 to M3

The non-safety-related alarm outputs M0, M1, M2, and M3, are designed as digital semiconductor outputs for 24 V DC/100 mA.

These alarm outputs can be used for example to control a standard PLC or a detector unit (e.g., a signal lamp).

As is the case for safe inputs and outputs, the alarm outputs are linked in the connection editor of SAFECNF (see "Adding and connecting functions, functional blocks, and signals in the safety logic" on page 4-11).



NOTE: Alarm outputs must not be connected in parallel. Feedback to alarm outputs is not permitted.

3.4.4 Test pulse outputs T0 and T1

The test pulses output at outputs T0 and T1 are used for cross-circuit detection at the inputs. Each output is available twice. The output test pulses T0 and T1 are asynchronous, i.e., T0 does not equal T1.

To implement cross-circuit detection, the relevant safe inputs must be configured accordingly using the device parameterization editor (part of the hardware editor in SAFECNF).

The SAFECNF configuration software specifies the clock signals to be used: Cross-circuit detection is implemented with test pulse T0 for "even" inputs (I0, I2, I4, ... I18). For "odd" inputs (I1, I3, I5, ... I19), test pulse T1 must be used for cross-circuit detection.

Please also refer to "Signal inputs" on page 3-7 and "Error detection in I/O devices" on page 2-8.

3.4.5 24 V/0 V supply connection

The 24 V/0 V supply connection is used to supply the outputs of the safety module and the clock and ground switching outputs with power.

3.4.6 Supply connections A1 and A2

The supply connection A1/A2 is used to supply the logic of the safety module and the alarm outputs with power.

At the double terminal block contacts, 2 and 3-wire sensors and control devices can be supplied directly by the safety module ($U_{nom} = 24 \text{ V DC}$).



VORSICHT: For 3-wire sensors, ensure that the GND potential of the sensor/control device matches the GND potential of the safety module.



The maximum continuous current for devices connected to terminal blocks A1 and A2 is 6 A (limiting continuous current for looped through current paths A1/A1 and A2/A2).

3.4.7 Ground switching outputs O0- and O1-

The ground switching outputs O0- and O1- increase the shutdown protection and cross-circuit protection of the safety system. These outputs can be used for example to switch off a contactor connected to the PSR-TRISAFE-S safety module either via the output or via ground.



Ground switching output O0- can only be used in connection with output O0, ground switching output O1- can only be used in connection with output O1.

The diagram below shows an example application: The two contactors, K1 and K2, are switched between safe module output O0 and ground switching output O-.

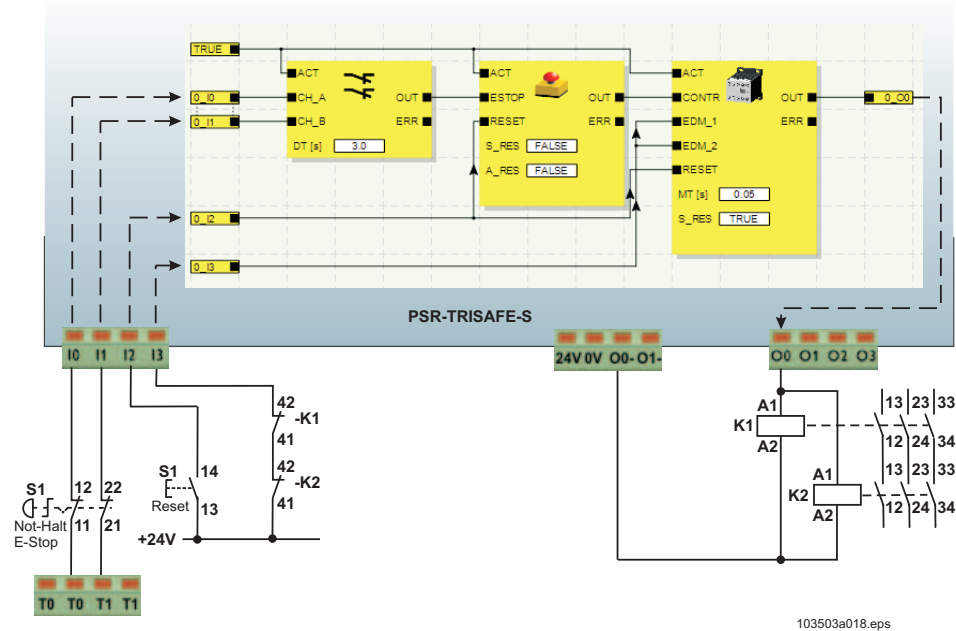

Figure 3-6 Example application for ground switching outputs O0- and O1-



In order to use the ground switching outputs, the corresponding parameters must be set for outputs O0 and O1 in the SAFECNF configuration software. For more detailed information, please refer to the online help topic "Parameterizing the I/Os of the safety module".

3.5 USB interface

The USB interface (standard USB 2.0) is used for communication between the PSR-TRISAFE-S safety module and the SAFECONF configuration software.

This includes:

- Downloading configuration data (i.e., the SAFECONF project)
- Optional upload of the configuration in order to open it as a project and edit it as required in SAFECONF
- Reading values from the safety module during operation and displaying the read values "live" in the connection editor of SAFECONF (online mode)
- Forcing signals on the running safety module for startup purposes (standard startup mode)



Before the PSR-TRISAFE-S safety module is connected to the configuration PC, the SAFECONF configuration software must be installed with the appropriate USB drivers for the module.



NOTE: Electrostatic discharge

The PSR-TRISAFE-S safety module contains components that can be damaged or destroyed by electrostatic discharge. When handling the USB interface, observe the necessary safety precautions against electrostatic discharge (ESD) according to EN 61340-5-1 and EN 61340-5-2.

Once the USB connecting cable (mini-USB connector, 5-pos., maximum cable length 3 m) has been connected, the appropriately configured PC detects the safety module automatically.

If the SAFECONF configuration software is already running, the software detects the status of the safety module and indicates it at the bottom right in the status bar.

Page 1, 1 Project: Read/Write PLC: Logged on PLC: Connected

Figure 3-7 Status bar in the SAFECONF configuration software (safety module already contains a configuration project)

3.6 IFS-CONFSTICK

The PSR-TRISAFE-S safety module is equipped with a plug-in memory module, the IFS-CONFSTICK.

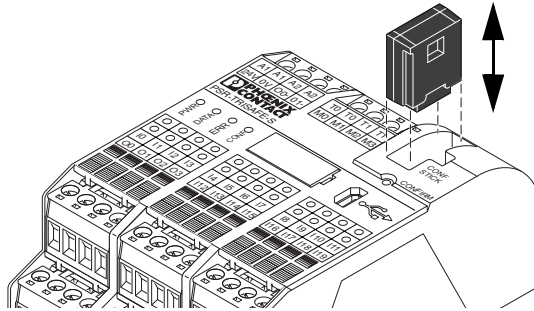

Figure 3-8 IFS-CONFSTICK on the PSR-TRISAFE-S

IFS-CONFSTICK as a hardkey

The IFS-CONFSTICK **must** be inserted in the PSR-TRISAFE-S safety module both during normal operation and for downloading configuration data from SAFECNF via the USB interface.

If no IFS-CONFSTICK is inserted in the safety module or if it is removed, the safety module behaves as follows:

- If no IFS-CONFSTICK is inserted when downloading configuration data, the configuration cannot be downloaded and SAFECNF outputs an error message.
- If no IFS-CONFSTICK is inserted when the safety module is started, the module sets all outputs to FALSE and indicates an error. The safety module does not execute any functions.
- If the IFS-CONFSTICK is removed during operation, the safety module sets all outputs to FALSE and indicates an error. The safety module does not execute any more functions.
- If the IFS-CONFSTICK is removed from the safety module and reinserted as described in "Downloading the configuration using the IFS-CONFSTICK" on page 5-7, the safety module sets all outputs to FALSE and does not execute any functions until the IFS-CONFSTICK is inserted again correctly. The safety module does **not indicate an error**.



As an alternative to downloading the configuration via the USB interface, it can be downloaded to the PSR-TRISAFE-S safety module using the IFS-CONFSTICK. For a description of this procedure, please refer to "Downloading the configuration using the IFS-CONFSTICK" on page 5-7.

3.7 Installing the safety module



WARNING: Serious personal injury or damage to equipment.

Disregarding this warning may result in damage to equipment and/or serious personal injury.

Only qualified personnel may connect the power, start up, and operate this device.

According to the safety instructions in this documentation, qualified personnel are persons who are authorized to start up, to ground, and to mark devices, systems, and equipment according to the standards of safety technology. In addition, these persons must be familiar with all warning instructions and maintenance measures in this document.

3.7.1 Mounting the safety module



VORSICHT: Risk of injury and damage to equipment.

Only mount and remove the PSR-TRISAFE-S safety module when the power supply is disconnected.

For standard extension modules, the PSR-TRISAFE-S safety module is equipped with an interface for the PSR TBUS DIN rail connector on the mounting side (see page 2-3).

The PSR TBUS DIN rail connector can be used to connect the MINI-SYS-PS system power supply unit or to connect gateways (e.g., for PROFIBUS) for transmitting standard diagnostic data. The PSR TBUS DIN rail connector eliminates the need for cross-wiring between the safety module and the gateway modules or system power supply unit.

The voltage can be supplied at any PSR device or using the system power supply unit via the PSR DIN rail connector (see "Connecting the supply voltage" on page 3-16).

3.7.1.1 Mounting



VORSICHT: Risk of damage to equipment due to incorrect installation.

During mounting, observe the following notes:

- Use only the yellow PSR TBUS DIN rail connector (Order No. 2890425) to connect the PSR-TRISAFE-S safety module. Connection with another DIN rail connector is not permitted.
- Use only the green PSR TBUS DIN rail connector (Order No. 2707437) to connect the standard extension modules. Connection with another DIN rail connector is not permitted.
- Standard extension units must be mounted to the left of the basic device.

To mount the PSR-TRISAFE-S safety module, proceed as follows:

Mounting a 35 mm DIN rail

1. The safety module should only be mounted on 35 mm DIN rails according to DIN EN 60715. To avoid contact resistance only use clean and corrosion-free DIN rails.

Mounting PSR TBUS DIN rail connectors (optional)

2. To use PSR TBUS DIN rail connectors to create a connection station with a system power supply unit or with extension units, proceed as follows:
 - Connect together the required number of PSR DIN rail connectors for the connection station (see Figure 3-9, A).
 - Snap this group of PSR DIN rail connectors onto the DIN rail (see B and C).

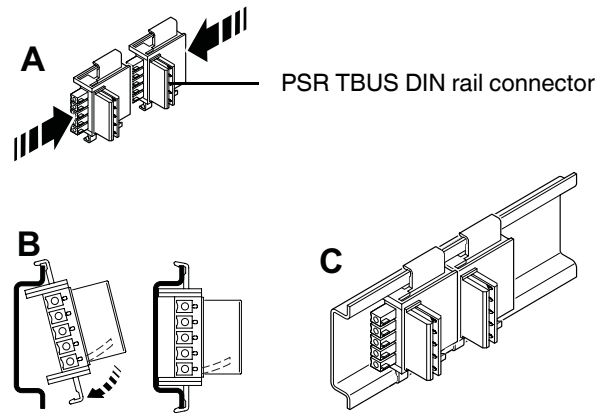

Figure 3-9 Mounting PSR TBUS DIN rail connectors

Mounting the PSR-TRISAFE-S safety module

3. Place the module onto the DIN rail from above as shown in Figure 3-10 so that the upper holding keyway of the module is hooked onto the top edge of the DIN rail. When using PSR DIN rail connectors, ensure that the contact opening in the base of the module is aligned correctly over the contact block of the PSR DIN rail connector.

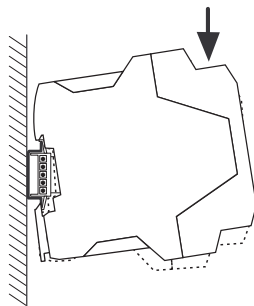

Figure 3-10 Attaching the PSR-TRISAFE-S safety module to the DIN rail

4. Push the lower part of the module that is furthest from the DIN rail towards the DIN rail until it engages with a click.
5. Check that the module is fixed securely on the DIN rail.
6. When mounting additional modules on the DIN rail (e.g., gateway extension modules or power supply unit), place them on the DIN rail with no spacing, i.e., in direct contact with the sides of the housing. All standard extension units must be mounted to the left of the PSR-TRISAFE-S safety module.
7. End clamps should be mounted on both sides of the module (or module group) to stop the module(s) from slipping on the DIN rail.

3.7.1.2 Removal

To remove the PSR-TRISAFE-S safety module, proceed as follows:

1. Pull the locking latch on the bottom of the module down using a screwdriver, for example, to release the module from the DIN rail.
2. Lift the bottom of the module away from the DIN rail slightly.
3. Pull the module diagonally upwards away from the DIN rail.

3.7.2 Connecting the supply voltage

The PSR-TRISAFE-S safety module has no main switch and is switched on simply by applying the supply voltage.

The safety logic and alarm outputs are supplied with power via connections A1/A2, the safe outputs, clock outputs, and ground switching outputs are supplied via connections 24V/0V.

Once the "PWR" status indicator is permanently on, the PSR-TRISAFE-S safety module is ready to operate.



Outputs "A1" and "A2" provide the supply voltage for supplying other modules, such as sensors (see "Supply connections A1 and A2" on page 3-9).

3.7.2.1 Direct connection of the supply voltage on the PSR-TRISAFE-S

Connect the supply voltage as follows:

1. Supply voltage for the safe module outputs, the clock and ground switching outputs at terminal block contacts "0V" and "24V", as shown in the diagram below.
2. Supply voltage for the logic of the safety module and the alarm outputs at terminal block contacts "A1" (24 V) and "A2" (0 V).

Once the supply voltage has been applied, the PSR-TRISAFE-S safety module executes an initialization routine (all LEDs on).

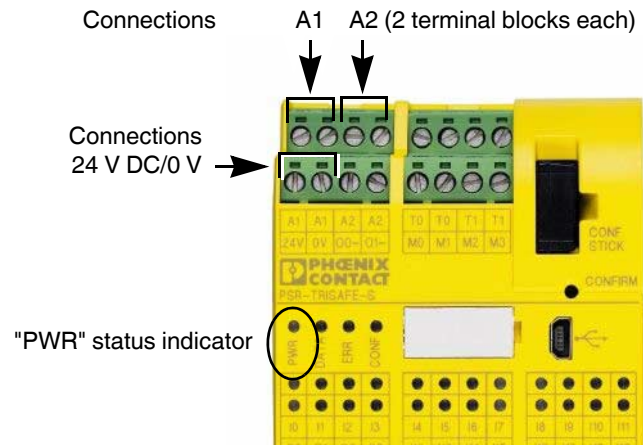

Figure 3-11 Connecting the supply voltage at A1/A2 and 24V/0V

3.7.2.2 Supply via system power supply unit

As an alternative, the devices can be supplied using the MINI-SYS-PS-100-240AC/24DC/1.5 system power supply unit (Order No. 2866983). The devices are then connected via the PSR TBUS DIN rail connector.

Usually the system power supply unit is mounted as the first device in a topology. A second power supply unit can be used to create a redundant supply concept.

3.7.3 Connecting the signal lines



VORSICHT: Ensure signal redundancy.

Ensure signal redundancy when connecting the signal lines of two-channel control devices and sensors to the inputs of the safety module. Please refer to "Signal inputs" on page 3-7.



VORSICHT: Avoid cross circuits and short circuits.

Prevent cross circuits and short circuits by using a suitable cable installation. Implement cross-circuit detection (see "Cross-circuit detection" on page 3-8).

Cable lengths

Many applications use large numbers of sensors or control devices. Depending on the size of the machine or system, a considerable amount of cabling may be required to wire the sensors. Make sure that the specified cable lengths are not exceeded, so as to ensure error-free operation of the safety circuits and therefore a reliable safety demand.

For reliable and touch proof contacts, strip the cable ends as follows:

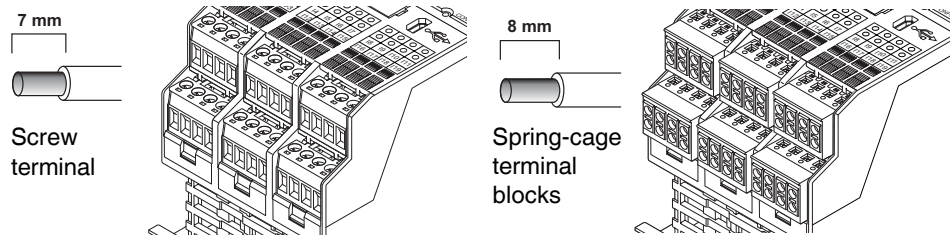

Figure 3-12 Connection to screw terminal blocks (left) and spring-cage terminal blocks (right)

4 SAFECONF configuration software

4.1 Installing SAFECONF

The installation routine for the configuration software also includes the installation of the required driver for the USB interface. This driver is required to enable communication between the PC on which SAFECONF is installed and the PSR-TRISAFE-S safety module.



To ensure that the configuration software detects the safety module automatically and correctly, the software must be fully installed on the computer before the device is connected for the first time.

Proceed as follows:

1. If you have **downloaded** the configuration software, extract the downloaded file and start the installation program (setup file).
If you have purchased the **PSR-SAFECONF-BOX**, insert the supplied CD in the drive. A graphical menu opens. Select "Install software" to start the installation program. (If you have deactivated the auto start option on your computer, open the "SAFECONF" folder on the CD and execute the setup file.)
2. Select the desired language for the installation routine. (This also sets the language for the SAFECONF user interface, which is set when the software is started for the first time.)
3. The installation program now guides you through the installation step by step. Follow the on-screen instructions.
4. Once SAFECONF is installed, you will be prompted to install the drivers for the safety module. Follow the on-screen instructions.
5. In the Windows dialog box for driver installation, select "Install the software automatically (recommended)".

Finally, a message appears indicating that the configuration software and drivers for the safety module have been fully installed.

4.2 Overview of functions and features

The SAFECONF safe configuration software is used only for the configuration of the PSR-TRISAFE-S safety module. The software supports the user in all operating phases, from planning the application, through configuration to starting up the PSR-TRISAFE-S safety module and compiling system documentation.

The following SAFECONF functions are available:

Creating the safety logic

- Creation of the safety logic using a graphical connection editor. The circuit which the safety module runs on is created by graphically linking safe functional blocks certified according to the PLCopen specification via connecting lines and safe functions. Safe functions range from logic operations such as AND, OR, etc., to timer and trigger functions.

- Linking I/Os with safety logic** – PSR-TRISAFE-S inputs and outputs are easily linked with the safety logic using drag & drop.
- Parameterizing I/Os** – Parameterization of the inputs and outputs of the PSR-TRISAFE-S safety module using a safe parameterization editor.
- Downloading/uploading the configuration** – Communication between the SAFECONF configuration software and the PSR-TRISAFE-S safety module:
You can download the configuration project, including all device parameters, to the safety module in just a few steps. It is also possible to upload the project saved on the safety module to the connected PC, in order to display or edit it in the configuration software.
- Online mode for function test** – Diagnostic and startup tools are included for communication:
During safe operation, you can easily read signal values from the safety module and display them in a special online mode. The connection editor indicates the current "live" status of each signal and the inputs and outputs of each functional block in the safety logic. The hardware editor in online mode maps the LEDs on the safety module.
- Startup mode (additional)** – In addition to the mandatory function test (activating safe control devices, e.g., emergency stop, safety door, etc.), standard startup mode can be used to execute a function test while the system is operating: For example, instead of pressing the actual switch, you can force the corresponding signal in the connection editor and test the safety logic in this way.
- Documentation, checklist** – The configuration software provides a detailed project information dialog box, where all information relating to the project can be stored and a safety-related checklist can be completed. This information dialog box is supplemented by an assignment list, where comments can be added to the signals of the safe devices used in order to document the wiring.
All documentation, including the graphical safety logic, the assignment list, and the device parameters, can be printed out in a clear format.
- EASYSIM simulation** – Simulation of the safety module, for example, for preliminary testing of the developed safety logic even if no safety module is available.
- Online help** A description of the wide range of functions offered by SAFECONF exceeds the scope of this user manual. However, the online help for the software contains detailed descriptions of each function.
To call the online help:
- In the "?" menu, select the "Help Topics" menu item.
The table of contents for the online help appears. Search for a help topic as described below.
 - Or: In an active input dialog box or window, press <F1>, for example, in the connection editor.
The context-sensitive online help for the active dialog box or window appears.
 - Or: In the connection editor, select an object and press<F1> in order to view information relating to that object. For safe functions and functional blocks, general information about the objects can be accessed in this way. There is also specific functional block information, which can be called via the "Help" context menu item for the relevant functional block or function.

4.3 Description of the user interface

This section provide an overview of the user interface for the SAFECONF configuration software. For more detailed information, please refer to the online help (see also "Online help" on page 4-2).

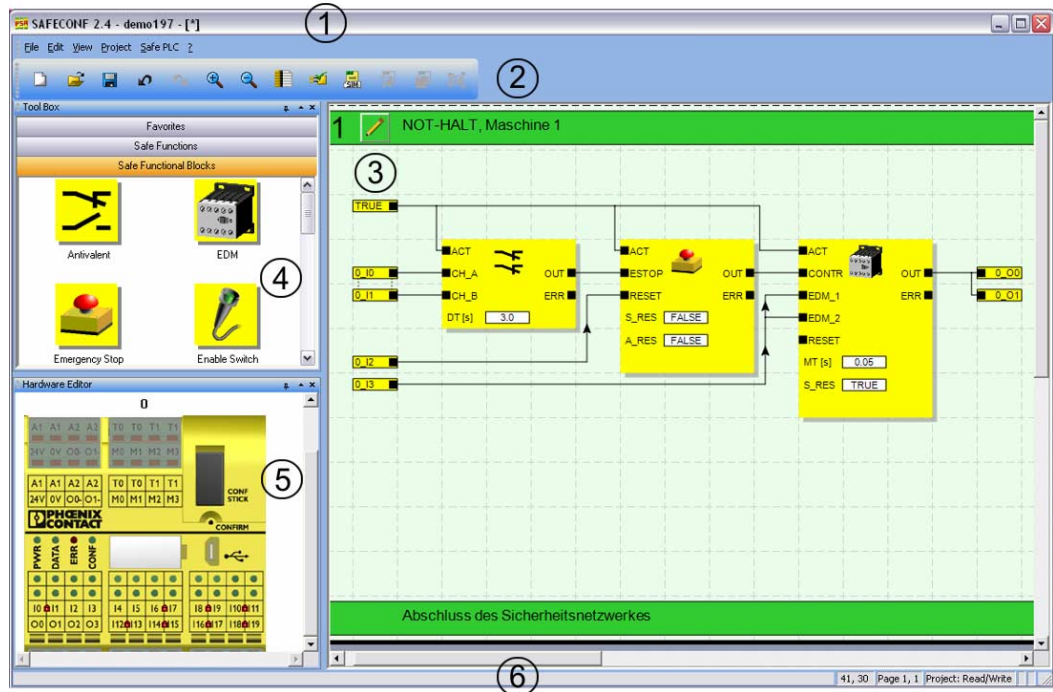

Figure 4-1 SAFECONF user interface



The windows may be arranged differently to the format shown here, either when the software is delivered or once you have adapted the program to your preferences.

The user interface consists of the following components:

1. **Menu**
The menus contain the available commands for controlling the SAFECONF configuration software.
2. **Toolbar**
Frequently used functions can be accessed quickly via the icons in the toolbar.
3. **Connection editor**
The connection editor is used to develop the safety logic by dragging graphical functional blocks from the toolbox and signals from the hardware window to the circuit (using drag & drop) and connecting them to one another.
4. **Toolbox**
The toolbox contains the safe functional blocks and safe functions. These elements can easily be dragged from the toolbox to the connection editor.

5. **Hardware editor**

The hardware editor contains a graphical representation of the PSR-TRISAFE-S safety module. When configuring the safety logic, input and output signals can be moved from here to the connection editor using drag & drop. Double-clicking on the hardware editor starts the safe device parameterization editor (not shown in the figure).

6. **Status bar**

When working with the configuration software, the status bar displays messages and information, as well as the current logon status, the status of the safety module, and transmission progress when downloading or uploading the configuration to or from the safety module.

The following windows and dialog boxes are not visible in the figure:

– **Message window**

The message window can be used to track the progress of the project checking function. When the check is started, the message window opens automatically. If the system detects an error when checking the project, the relevant error location can be accessed directly by double-clicking with the left mouse button on the message in the message window.

– **Assignment list for signals**

The assignment list contains the signal assignments for the individual inputs and outputs of the PSR-TRISAFE-S safety module. It provides "wiring documentation", which makes the project easier to understand, and helps to prevent incorrect connections being established in the connection editor.

– **Project information dialog box**

This dialog box can be used to enter and display the most important information for the current configuration project (e.g., project-related data, manufacturer data, operator, installation location, data relating to safety inspections, revision history for the project).

4.4 Safe functional blocks and functions

The PSR-TRISAFE-S safety module is configured in the SAFECONF configuration software by graphically connecting prepared safe functions and safe functional blocks.

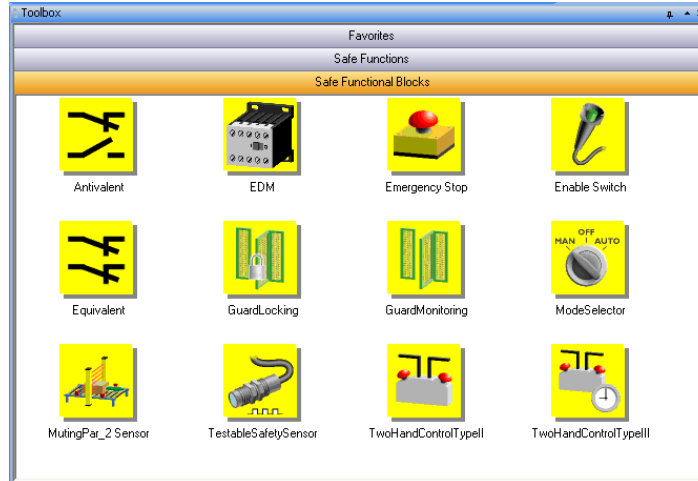

Figure 4-2 Safe functional blocks in the toolbox (excerpt)

The connections are made intuitively using the mouse, and the editor prevents impermissible connections (e.g., between certain outputs).

The safe functions include simple Boolean operations and basic functions used in standard digital technology.

Safe functions

The following safe functions are available in the SAFECONF toolbox and can be easily added to the safety logic using drag & drop (in alphabetical order):

- AND (Boolean ANDing)
- EQ (Boolean comparison)
- F_TRIG (detection of a falling edge)
- NOT (complement or negator)
- NOT_EQ (comparison for Boolean inequality)
- OR (Boolean ORing)
- PULSE_GEN (safe pulse generator)
- R_TRIG (detection of a rising edge)
- RS (bistable function: priority for resetting)
- SR (bistable function: priority for setting)
- TOF (timer for off delay)
- TON (timer for switch-on delay)
- TP (impulse encoder)
- XOR (Boolean EXORing)

Safe functional blocks

The safe functional blocks provide basic safety-related functions for implementing the required safety circuits. Table 4-1 lists the available functional blocks in alphabetical order.

Table 4-1 Safe functional blocks

Name Icon in editor	Short description
<p>Antivalent</p>  <p>The icon for the Antivalent block is a yellow rectangle with a black border. It contains a switch symbol. On the left, there are two input checkboxes labeled 'ACT' and 'CH_NO'. On the right, there are two output checkboxes labeled 'OUT' and 'ERR'. At the bottom, there is a text input field for 'DT [s]' with the value '0.5'.</p>	<p>The Antivalent safe functional block monitors the signals of two safe input terminal blocks for different signal states. Typically, these signals come from two-channel sensors or switches, such as an emergency stop control device.</p>
<p>EDM</p>  <p>The icon for the EDM block is a yellow rectangle with a black border. It contains a contactor symbol. On the left, there are four input checkboxes labeled 'ACT', 'CONTR', 'EDM_1', and 'EDM_2'. On the right, there are two output checkboxes labeled 'OUT' and 'ERR'. At the bottom, there are two text input fields: 'MT [s]' with the value '0.05' and 'S_RES' with the value 'FALSE'.</p>	<p>The EDM (external device monitoring) safe functional block monitors the defined initial state and the switching behavior of contactors connected to the safety module.</p>
<p>EmergencyStop</p>  <p>The icon for the EmergencyStop block is a yellow rectangle with a black border. It contains a red emergency stop button symbol. On the left, there are three input checkboxes labeled 'ACT', 'ESTOP', and 'RESET'. On the right, there are two output checkboxes labeled 'OUT' and 'ERR'. At the bottom, there are two text input fields: 'S_RES' with the value 'FALSE' and 'A_RES' with the value 'FALSE'.</p>	<p>The EmergencyStop safe functional block monitors the switching states of an emergency stop control device. When the connected emergency stop device is actuated, the enable signal at output OUT is set to FALSE.</p>
<p>EnableSwitch</p>  <p>The icon for the EnableSwitch block is a yellow rectangle with a black border. It contains a three-position enable switch symbol. On the left, there are five input checkboxes labeled 'ACT', 'S_ACT', 'S_1', 'S_2', and 'RESET'. On the right, there are two output checkboxes labeled 'OUT' and 'ERR'. At the bottom, there is a text input field for 'A_RES' with the value 'FALSE'.</p>	<p>The EnableSwitch safe functional block evaluates the signals of a manually actuated three-position enable switch (according to DIN EN 60204) in order to identify its switch position and switching direction. This means that an enable switch can be used to remove safeguarding, provided that the appropriate safe operating mode (e.g., limitation of the speed or range of motion) is selected and active.</p>
<p>Equivalent</p>  <p>The icon for the Equivalent block is a yellow rectangle with a black border. It contains a switch symbol. On the left, there are three input checkboxes labeled 'ACT', 'CH_A', and 'CH_B'. On the right, there are two output checkboxes labeled 'OUT' and 'ERR'. At the bottom, there is a text input field for 'DT [s]' with the value '3.0'.</p>	<p>The Equivalent safe functional block monitors the signals of two safe input terminal blocks for the same signal states. Typically, these signals come from two-channel sensors or switches, such as an emergency stop control device.</p>

Table 4-1 Safe functional blocks (Fortsetzung)

Name Icon in editor	Short description
<p>ESPE</p> 	<p>The ESPE (electrosensitive protective equipment) safe functional block monitors the switching states of electrosensitive protective equipment (e.g., light grids). When the protective equipment is triggered, i.e., the light grid beam is interrupted, the enable signal at output OUT is set to FALSE.</p>
<p>GuardLocking</p> 	<p>The GuardLocking safe functional block supports the monitoring of a guard with guard locking (safety door monitoring with four-state interlocking according to DIN EN 1088).</p>
<p>GuardMonitoring</p> 	<p>The GuardMonitoring safe functional block monitors a guard (e.g., safety door) with two-state interlocking according to DIN EN 1088.</p>
<p>ModeSelector</p> 	<p>The ModeSelector functional block evaluates the states of a mode selector switch with up to five positions.</p> <p>A mechanical mode selector switch can be used, for example, to set a specific safety level (e.g., service mode, setup mode, cleaning mode, etc.) for operation of the safe application.</p>

Table 4-1 Safe functional blocks (Fortsetzung)

Name Icon in editor	Short description
 <p>The icon for MutingPar_2Sensor shows a yellow background with a small diagram of a light grid. It lists inputs: ACT, A_IN, MS_11, MS_12, MLAMP, ENAB, RESET. It has two time delay inputs: DTE [s] (1.0) and MMT [s] (1.0). It has an S_RES input (FALSE). It has two outputs: M_ACT and ERR.</p>	<p>The MutingPar_2Sensor safe functional block evaluates the signals of two muting sensors and one optoelectronic protective device (e.g., light grid) in an application for parallel muting using two sensors and sets the enable signal at output OUT.</p> <p>This function can be used to temporarily deactivate (or "mute") protective equipment in the form of a light grid, for example, in order to allow an object which has been identified by the muting sensors as permissible (for the muting operation) to pass through on an assembly conveyor.</p> <p>However, if the light grid is interrupted by a worker's hand, for example, output OUT is set to FALSE to disable the hazard, as the protective equipment had not been previously "muted".</p>
 <p>The icon for MutingPar shows a yellow background with a small diagram of a light grid. It lists inputs: ACT, A_IN, MS_11, MS_12, MS_21, MS_22, MLAMP, ENAB, RESET. It has two time delay inputs: DT1 [s] (1.0) and DT2 [s] (1.0). It has an S_RES input (FALSE). It has two outputs: M_ACT and ERR.</p>	<p>The MutingPar safe function block evaluates the signals of four muting sensors and one item of optoelectronic safety equipment (a light grid, for example) in an application for parallel muting with four sensors. It also switches the enable signal at the OUT output.</p> <p>This function can be used to temporarily deactivate (or "mute") safety equipment in the form of a light grid, for example, in order to allow an object which has been identified by the muting sensors as permissible (for the muting operation) to pass through on an assembly conveyor.</p> <p>By contrast, if the light grid is interrupted by a worker's hand, for example, the OUT output switches to FALSE to disable the hazard, as the safety equipment had not been previously "muted".</p> <p>The maximum allowable time for the muting operation is monitored using the four muting sensors.</p>
 <p>The icon for MutingSeq shows a yellow background with a small diagram of a light grid. It lists inputs: ACT, A_IN, MS_11, MS_12, MS_21, MS_22, MLAMP, ENAB, RESET. It has one time delay input: MMT [s] (1.0). It has an S_RES input (FALSE). It has two outputs: M_ACT and ERR.</p>	<p>The MutingSeq safe function block evaluates the signals of four muting sensors and one item of optoelectronic safety equipment (a light grid, for example) in an application for sequential muting with four sensors. It also switches the enable signal at the OUT output.</p> <p>This function can be used to temporarily deactivate (or "mute") safety equipment in the form of a light grid, for example, in order to allow an object which has been identified by the muting sensors as permissible (for the muting operation) to pass through on an assembly conveyor.</p> <p>By contrast, if the light grid is interrupted by a worker's hand, for example, the OUT output switches to FALSE to disable the hazard, as the safety equipment had not been previously "muted".</p> <p>The maximum allowable time for the muting operation is monitored using the four muting sensors.</p>

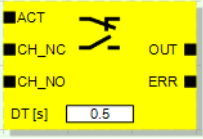
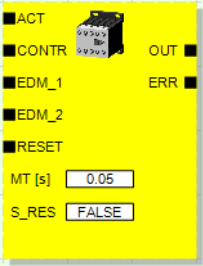
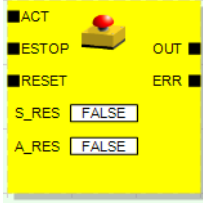
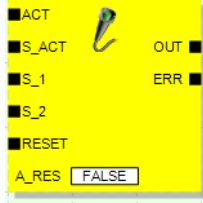
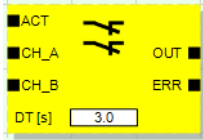
Table 4-1 Safe functional blocks (Fortsetzung)

Name Icon in editor	Short description
<p>TestableSafetySensor</p> 	<p>The TestableSafetySensor functional block evaluates the status of a connected optoelectronic protective device (e.g., light curtain).</p> <p>The functional block also has a test function for checking the connected protective equipment.</p>
<p>TwoHandControlTypeII</p> 	<p>The TwoHandControlTypeII safe functional block evaluates the switching behavior of a Type II two-hand control device connected to the safety module.</p>
<p>TwoHandControlTypeIII</p> 	<p>The TwoHandControlTypeIII safe functional block evaluates the switching behavior of a Type III two-hand control device connected to the safety module.</p>

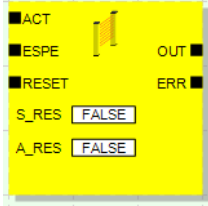
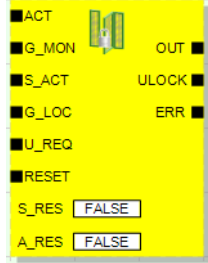
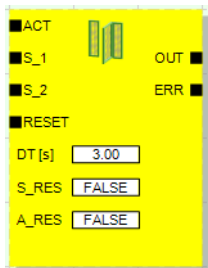
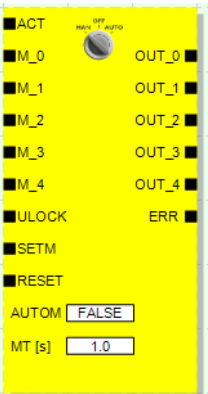

A detailed description of each functional block and function is available in the online help. To open the help for a particular safe functional block or safe function, right-click on the corresponding block in the SAFECONF connection editor and select "Help" from the context menu.

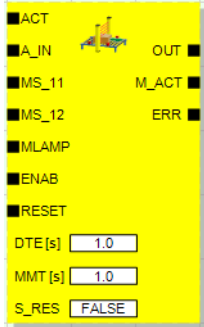
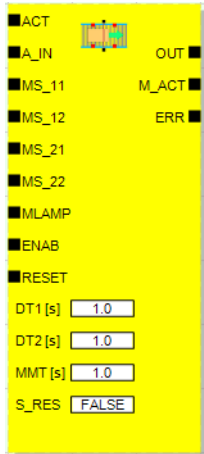
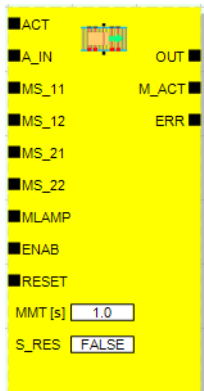
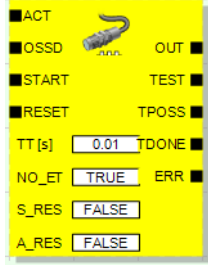
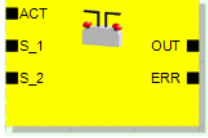
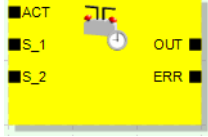
4.5 Operating the SAFECONF configuration software

Intuitive operation

The SAFECONF configuration software follows the Windows standard for all user activities. However, SAFECONF offers a wide range of functions, which far exceeds the standard level of performance in this sector. Examples include online diagnostic tools and simulation of the safety module.

Details in the online help

A description of the wide range of functions exceeds the scope of this user manual, therefore please refer to the online help, which contains a detailed description of each software function.

For an overview of the steps required when configuring a project, please refer to "Configuration overview from A to Z" on page 5-1.

The following sections provide a brief introduction to the most important software functions.

4.5.1 Creating the configuration project

When creating a new project, either use a project template or create an empty project using the Project Wizard.

"Empty" means that although the safety module is already available in the hardware editor for "wiring" the signals, the connection editor does not yet contain any safety logic.

If a project template is used, a predefined circuit, which can be modified or extended as required, will be inserted into the connection editor.

To create a new project, select "New Project..." in the "File" menu, use the keyboard shortcut <Ctrl>+<N> or click on the following icon:



In the "New Project" dialog box that appears, select either the Project Wizard or a specific project template.

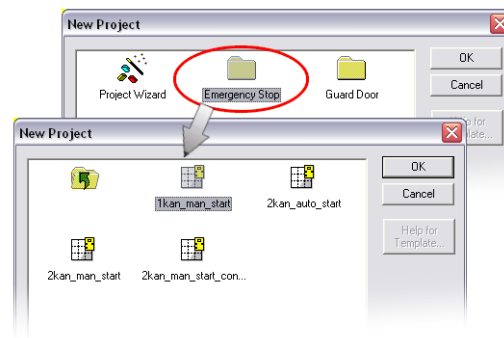

Figure 4-3 Project Wizard for creating a new configuration project, using a project template

4.5.2 Adding and connecting functions, functional blocks, and signals in the safety logic

The safety logic is created in the connection editor as a network of safe functions and functional blocks. They are available in the various sections of the toolbox and must be inserted in the connection editor from there.

In order to process the various signals (inputs, outputs, and alarm outputs of the PSR-TRISAFE-S safety module) in the connection editor, the signals must be inserted in the connection editor from the hardware editor and connected to other objects.



Input and output signals can only be inserted into the connection editor from the hardware editor and linked to functional blocks in the connection editor if you have logged on with the correct project password ("Log On" in the "Project" menu).

Functional blocks and functions in the toolbox

Safe functional blocks/functions and constants are always inserted into the connection editor from the toolbox using drag & drop. To do this, proceed as follows:

1. Display the toolbox ("Toolbox" in the "View" menu). If the auto-hide function is enabled, position the cursor over the minimized window as shown in Figure 4-5 for the hardware editor.
2. In the toolbox, open the required section by clicking on the corresponding navigation bar ("Safe Functions", "Safe Functional Blocks" or "Favorites").
3. Drag the required object into the connection editor from the toolbox section:
 - Left-click on the required object and hold the mouse button down.
 - Hold the left mouse button down and drag the object from the toolbox to a free position in the safety logic and then release the mouse button.
 - Signal constants can be dragged directly to functional block connections, thus establishing the connection immediately on insertion.

The object is stored at the selected position (oriented on the grid of the connection editor).

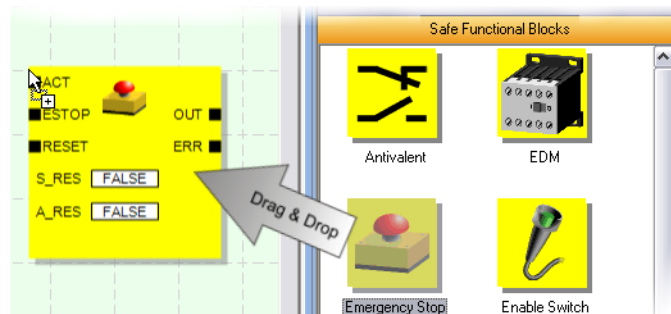

Figure 4-4 Inserting safe functional blocks and functions from the toolbox in the connection editor

Signal inputs and signal outputs in the hardware editor

Input and output signals of the safety module are always inserted into the connection editor from the hardware editor using drag & drop. To do this, proceed as follows:

1. Display the hardware editor ("Hardware Editor" in the "View" menu). If the auto-hide function is enabled, position the cursor over the minimized window as shown in the figure below.

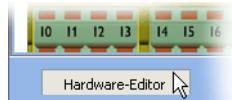

Figure 4-5 Opening the hardware editor with the auto-hide function enabled

2. Drag the required (dual) input signal or output signal from the hardware editor into the connection editor as follows (see Figure 4-6 on page 4-12):
 - Left-click on the required (dual) signal and hold the mouse button down. Please refer to the information below on using dual signals.
 - Hold the left mouse button down and drag the (dual) signal from the hardware editor directly to a free connection (or two free connections, in the case of a dual signal) in the safety logic, then release the mouse button.
 - Alternatively, you can store signals at any free position in the connection editor. The free signals must then be linked to free functional block connections manually (see "Connecting objects" on page 4-14).

The (dual) signal is stored at the selected position (aligned with the grid) and, if applicable, directly connected to the corresponding connection.

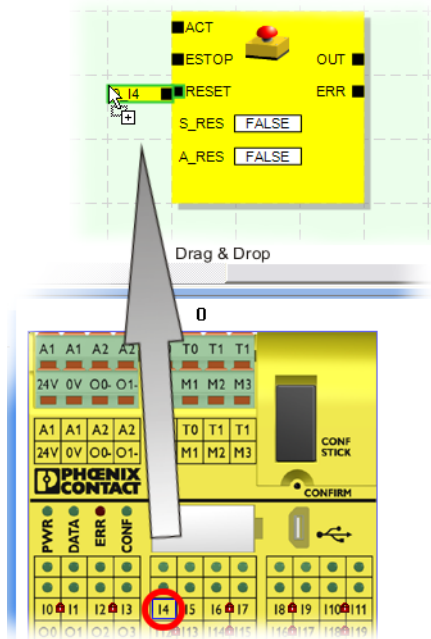

Figure 4-6 Inserting a signal in the connection editor

**Ensuring signal redundancy by using dual signals:**

When evaluating two-channel sensors or control devices, dual signals should always be used to connect the two channels.

Dual signals always consist of one "even" and one "odd" input signal, e.g., I0 and I1.

As input signals with even and odd IDs are processed in different ways in the safety module, using dual signals ensures that the safety module will perform redundant processing.

If required, dual signals can be split into two individual signals.

Please note: Dual signals are not connected to one another internally; they are simply grouped together.



Standard alarm signals M0 to M3: As well as 20 safe inputs and four safe outputs, the safety module also provides four non-safety-related alarm outputs. These alarm outputs can be used, for example, to control a standard PLC or a simple detector unit (e.g., a signal lamp). Since the alarm signals are not safe, they are shown in gray rather than yellow in the connection editor.

Alarm outputs are edited in the same way as safe I/O signals.



Clock outputs T0 and T1 of the safety module cannot be moved to the connection editor using drag & drop. To implement cross-circuit detection using these two test pulses, the relevant safety module inputs must instead be parameterized accordingly.

Connecting objects

As shown in Figure 4-6 on page 4-12, signal inputs and outputs as well as constants can be connected as soon as they are inserted in the connection editor (using drag & drop).

Free terminal points are connected as described below.

Connecting objects by drawing a connecting line

1. Position the cursor over the connection area where the connecting line is to start. The cursor now appears as a cross (see (1) in the figure below).
2. Left-click, hold the mouse button down, and drag the mouse directly to the destination connection area.
If the connection is permitted, the line is green.
If the connection between the two objects is not permitted, the line is not displayed in green. In this case, no connection can be established.
3. Now release the mouse button to create the connection. The connection editor automatically determines the path for the connecting line (automatic routing).

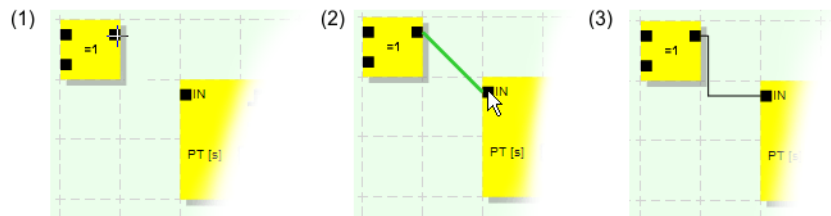

Figure 4-7 Connecting objects using a line

Connecting objects using drag & drop

This method is only suitable for connecting inputs, outputs, and signal constants.

1. Click on the (dual) signal or the constant to be connected and hold the mouse button down (see Figure 4-8).
2. Drag the object to the desired destination connection point. If the relevant signals and connection areas are displayed within a green border (see Figure 4-8, (1)), release the mouse button.
If the connection between the two objects is not permitted, these items are not displayed within a green border. In this case, no connection can be established.

The dragged object is positioned automatically and the connecting line is also created automatically (automatic routing).

If required, the objects can then be moved, whereby the connection editor manages the connecting lines automatically.

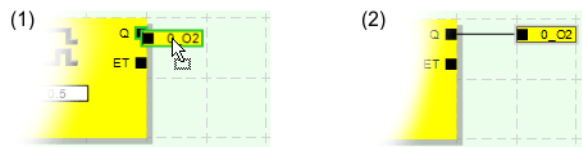

Figure 4-8 Connecting unconnected signals to functional blocks or functions using drag & drop

4.5.3 Device parameterization in the safe parameter editor

The inputs and outputs of the safety module can be parameterized. Specific properties can be defined for each input and output in a special safe parameter editor.

When checking a project in the SAFECONF configuration software, this data is used to create a parameterization file, which is subsequently transmitted to the safety module automatically as part of the configuration project.



The parameters can only be edited if you have logged on with the correct project password ("Log On" in the "Project" menu).

Opening the device parameterization editor

The device parameterization editor is a component of the hardware editor. To open this editor for all I/Os (general view), double-click on the representation of the safety module in the hardware editor.

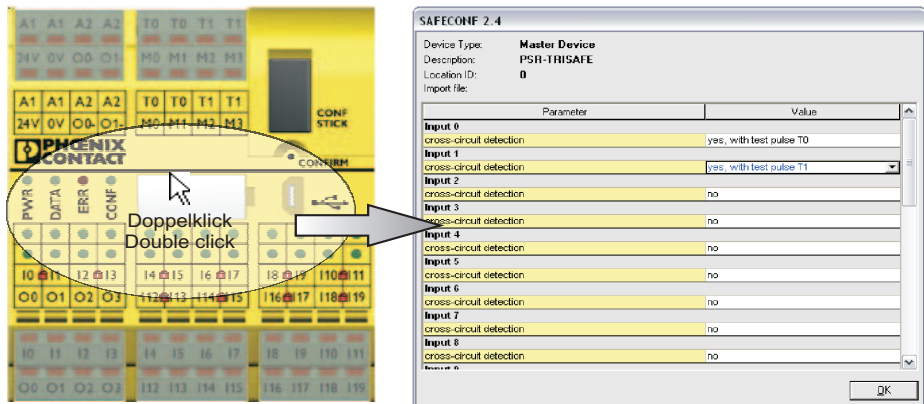

103503a016.eps

Figure 4-9 Opening the device parameterization editor for all I/Os

To open the device parameterization editor for only one specific I/O, double-click on the relevant signal in the graphical representation of the device:

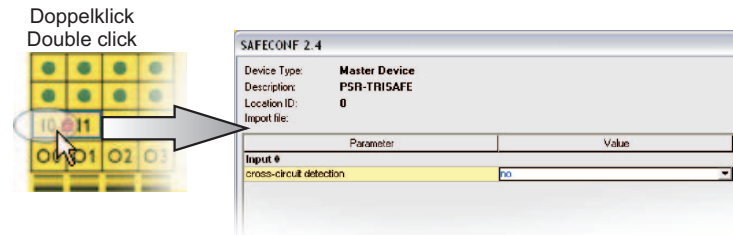

103503a021.eps

Figure 4-10 Opening the device parameterization editor for one specific I/O

Instead of double-clicking, you can also open the device parameterization editor via the context menu. Right-click either directly on a specific I/O to open the parameters for this I/O, or on any empty position in the graphical representation of the device to open the general view.

In both cases, select "Parameters" from the context menu.

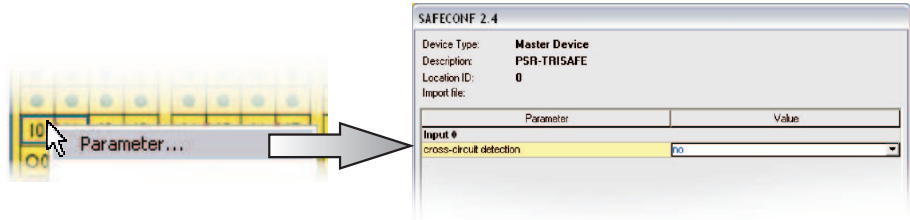

Figure 4-11 Opening the device parameterization editor via the context menu

Structure of the device parameterization editor

The adjustable parameters are provided in table format.

At the top left of the table is the device type or the device ID and the "location ID", which is the unique security ID for the safe device. Every safe device can be clearly identified using just this ID. Underneath is the name of the import file, provided that you have imported parameters (see the "Importing/exporting" section).

The available parameters are then listed row by row (see description of input parameters and output parameters). Every parameter (i.e., every table row) consists of a value, which can be modified, and the parameter name (which cannot be modified). Please read the next section for more information.

Modifying device parameters

In the interests of security, only predefined parameter values can be selected. Proceed as follows:

1. Click in the white field of the parameter you wish to change. The field now displays an arrow for opening a selection list.
2. Click on the arrow to open up the list.
3. Click on the required value. This list is closed and the selected value is visible in the parameter field.

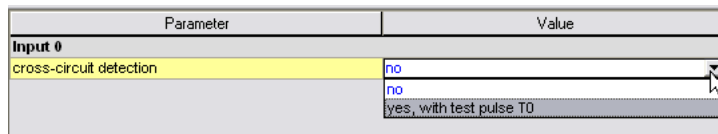

Figure 4-12 Modifying device parameters in the device parameterization editor

Unless the device parameterization editor is closed or another device is selected, several editing steps can be undone (<Ctrl>+<Z>) and redone (<Ctrl>+<Y>).

If you have modified parameters and then close the editor with "OK", you are prompted to save the changes that have been made.

**Input parameters for the safety module:
Cross-circuit detection**

A "cross circuit" is an unintentional, incorrect connection between redundant circuits. The safety module provides clocked outputs T0 and T1 as an aid for detecting such a cross circuit.

To activate cross-circuit detection for an output, set the corresponding cross-circuit detection parameter ("no"/"yes, with test pulse T...") to "yes, with test pulse T..." (see Figure 4-12 above).



The SAFECONF configuration software specifies the clock signals to be used: Cross-circuit detection is implemented with test pulse T0 for "even" inputs (I0, I2, I4, ... I18). For "odd" inputs (I1, I3, I5, ... I19), test pulse T1 must be used for cross-circuit detection. For additional information about cross-circuit detection, please refer to "Signal inputs" on page 3-7 and "Error detection in I/O devices" on page 2-8. An application example is also provided there.

**Output parameters for the safety module:
Ground switching output**

The "additionally ground switching contact" parameter "no"/"yes, with O...-" is only available for outputs O0 and O1. Output O0 is connected to ground switching output O0-, output O1 to ground switching output O1-.

This parameter is used to specify whether the specified ground switching output, which can assist in shutting down a single-channel application safely, should be switched in addition to the relevant safe module output.



Use of ground switching outputs O0- and O1- increases the cross-circuit protection. For more detailed information about using ground switching outputs O0- and O1- and a corresponding example application, please refer to "Ground switching outputs O0- and O1-" on page 3-10.

Parameter	Value
Output 0	
additionally ground switching contact	yes, with O0-

Figure 4-13 Setting the device parameter for the use of ground switching output O0-

Exporting and importing parameters

Once the inputs and outputs of the safety module have been parameterized, the parameter list can be exported to a file so that it can be used again later.

For information about exporting and importing parameters, please refer to the online help (see "Parameterizing the I/Os of the safety module").

Printing parameters

The print dialog box ("Print Project" in the "File" menu) contains a "Safe parameters" checkbox. If this checkbox is selected before printing a project, all the parameters of the safe device are printed too.

4.5.4 Checking, downloading, and starting up the project



The project can only be checked if you have logged on with the correct project password ("Log On" in the "Project" menu).



If the current project status has not yet been saved, this is done automatically prior to checking.



Check values (CRC): To ensure that any distortions to the configuration data during transmission to the safety module can be reliably detected, a check value (CRC) is calculated in the configuration software when the project is checked. The safety module also determines the check value for the downloaded data. If the check values on the safety module and in the configuration software are identical, all data has been saved on the safety module without distortion. If the check values differ, a corresponding error message is output.

The check value (CRC) will also differ if **subsequent modifications** have been made to the project in the configuration software, but have not yet been downloaded to the safety module. A change to the product documentation can also modify the check value, for example.

Once the configuration project has been developed, i.e., the safety logic and the device parameterization have been completed, the project must be checked. This involves checking the safety logic for errors, such as open function inputs.

To check the project, proceed as follows:

1. Click on the "Check Project" icon in the toolbar:



2. The progress of the checking function can be tracked in the message window, which opens automatically:

If the configuration software detects an error, the relevant error location can be accessed directly by double-clicking with the left mouse button on the message in the message window.

In the example below, an input is not connected. Double-clicking on the error message highlights the affected object (in a green border) in the connection editor.

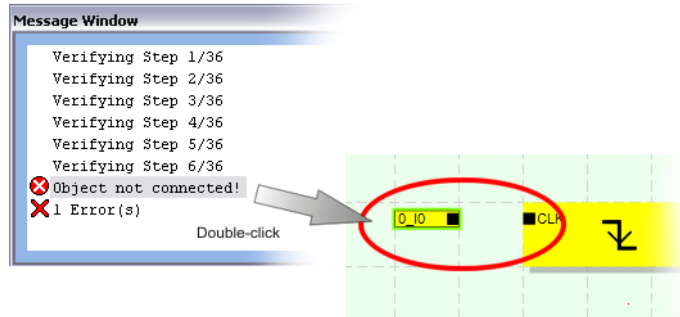

Figure 4-14 Jumping to an error location in the safety logic from the message window when checking the configuration project

3. Correct the error and check the project again.

- Once a check has been completed without errors, the project can be transmitted to the safety module. For information about downloading a configuration project and the associated startup of the safety module, please refer to "Downloading the configuration from SAFECONF" on page 5-4.

4.5.5 Documenting the signal assignment and the project

Documenting signal assignment

The system offers the option of maintaining a signal list or, more accurately, a signal assignment list.



We strongly recommend that this "wiring documentation" is maintained on an ongoing basis, as it makes both the safety logic that has been created and the project as a whole easier to understand, and helps to prevent incorrect connections being established in the connection editor. In practice, it is better to enter signal names before editing the safety logic because any text entered in the connection editor is visible as tool tips.

- Click on the following icon in the toolbar:



The "Assignment Map" dialog box opens.

- For each input, enter a meaningful short description in the right-hand field of the list by double-clicking in the field and typing in the text.

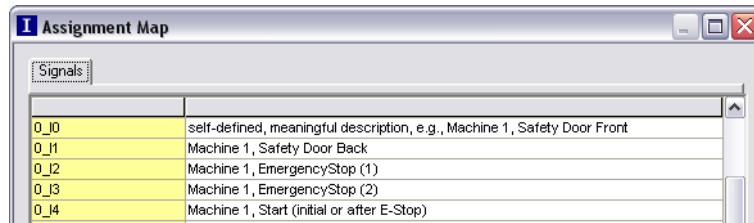

Figure 4-15 Documenting signal assignment in the "Assignment Map" dialog box

- Once all the required texts have been entered, confirm the dialog box with "OK" to save the signal list.



For additional information about signal information, please refer to the online help, which is opened by pressing <F1> when the "Assignment Map" dialog box is active.

Entering project documentation

Open the "Project Info" dialog box by selecting "Project Information..." in the "Project" menu.

This dialog box can be used to enter the most important information about the current project, from project-specific data (description of the application, designation, name of the creator/editor, etc.) to manufacturer data, the operator, and installation location, through to data relating to safety inspections, and a revision history for the project.



To ensure compliance with standards, the fields with yellow row headers must be completed each time a new project version is developed. The fields with a gray background are less important. However, it is highly recommended that you enter data in all fields.



Check values (CRC): If the project documentation is modified, the check value is recalculated, i.e., the system detects that the project on the safety module differs from the configuration project. If the check values on the safety module and in the configuration software are not identical, a corresponding message is output.



For additional information about project information and documentation, please refer to the online help, which is opened by pressing <F1> when the "Project Information" dialog box is active.

Printing project documentation

The entire project can then be printed.

1. In the "File" menu, select "Print Project".
A dialog box of the same name appears.
2. Select all checkboxes in the dialog box and click "OK".



For additional information about printing, page layouts, and print settings, please refer to the online help, which is opened by pressing <F1> when the "Print Project" dialog box is active.

4.6 Simulation mode in SAFECONF

The SAFECONF configuration software includes the EASYSIM controller simulation, which can be used to simulate the execution of the safety logic:

- If no PSR-TRISAFE-S safety module is available
- If a simulated function test is recommended prior to actual startup of the "real" PSR-TRISAFE-S safety module

	✓	Name	Value	Preset 1	Preset 2	Preset 3	Data type	Description	Terminal
2	✓	0_M1	●				BOOL	Meldeausg...	M1 - Meldeaus...
5	✓	0_I0	●	●	●	●	SAFEBOOL	Klemme 3.1	I0 - Klemme 3.1
6	✓	0_I1	●	●	●	●	SAFEBOOL	Klemme 3.2	I1 - Klemme 3.2
7	✓	0_I2	●	●	●	●	SAFEBOOL	Klemme 3.3	I2 - Klemme 3.3
8	✓	0_I3	●	●	●	●	SAFEBOOL	Klemme 3.4	I3 - Klemme 3.4
9	✓	0_I4	●	●	●	●	SAFEBOOL	Klemme 3.5	I4 - Klemme 3.5
10	✓	0_I5	●	●	●	●	SAFEBOOL	Klemme 3.6	I5 - Klemme 3.6
11	✓	0_I6	●	●	●	●	SAFEBOOL	Klemme 3.7	I6 - Klemme 3.7
12	✓	0_I7	●	●	●	●	SAFEBOOL	Klemme 3.8	I7 - Klemme 3.8
13	✓	0_I8	●	●	●	●	SAFEBOOL	Klemme 3.9	I8 - Klemme 3.9
17	✓	0_O0	●				SAFEBOOL	Klemme 4.1	O0 - Klemme 4.1
18	✓	0_O1	●				SAFEBOOL	Klemme 4.2	O1 - Klemme 4.2
19	✓	0_O2	●				SAFEBOOL	Klemme 4.3	O2 - Klemme 4.3

Figure 4-16 Simulation of the safety module in SAFECONF



WARNING: A simulation does not replace a function test.

The simulation of the safety application must **not** replace the proper function test using the safety module and safe control devices/sensors/actuators. The test using simulation may only be performed in addition to the standard function test, as a preliminary test, for example.

When working with the EASYSIM simulation instead of the safety module:

- If a safety module is connected, it will not be addressed, i.e., its inputs will not be read and its outputs will not be written.
- Execute the same steps in the SAFECONF configuration software as you would if you were working with the real safety module, but ensure that the "Simulate Safety Controller" icon on the toolbar is activated (see Figure 4-17 on page 4-22). This means that you can force signals or display online values in the connection editor as usual. The simulation continues to run in the background, with the icon visible in the taskbar notification field (system tray, known as systray for short).
- The simulation can be configured for the current application, inputs can be "activated" in the simulation directly, and the effects on outputs can be monitored, thus simulating the I/Os of the actual hardware.
- The timing of the machine/system can be simulated in expert mode.

Starting simulation mode

To start the simulation and download a project, proceed as follows:

1. To start the simulation, click on the "Simulate Safety Controller" icon in the toolbar. If the icon is activated, the simulation is active and all commands executed, such as "Download" or "Online Values", will relate to the simulation.

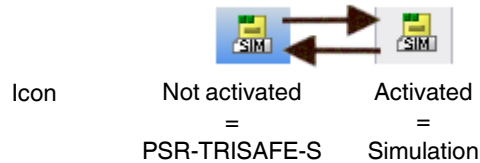

Figure 4-17 Icon for simulation mode, "not activated" and "activated"

2. Once the icon has been selected, a message window appears stating "Simulation being activated". The project is then saved and checked automatically. Any errors detected are output in the message window.
3. Once a check has been completed without errors, the project can be downloaded as usual by clicking on the icon of the same name in the toolbar:



Unlike with the actual safety module, you do not have to log on with a controller password when using the simulation.

4. Once the simulation has been started, the following entry is indicated on the far right in the status bar:

Simulation: Connected

The EASYSIM application is now minimized in the Windows taskbar.

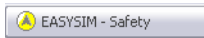

Figure 4-18 EASYSIM icon in the Windows taskbar

Exiting SAFECONF simulation mode

To switch from the EASYSIM simulation to the real safety module, in the SAFECONF configuration software click on the simulation icon in the toolbar, which already appears "activated":



The simulation is now deactivated (see information in the message window) and the project is saved automatically again and checked for use with the real safety module.



WARNING: Risk of unintentional operations.

As soon as simulation mode is exited, all "online" operations, such as downloading or forcing signals, affect the real safety module again.

**Exiting simulation mode is not the same as exiting the EASYSIM simulation.**

Once the "Simulate Safety Controller" icon is selected again, the destination system is reset in the configuration software, from the EASYSIM simulation to the real PSR-TRISAFE-S safety module. This means that, essentially, the connection between the configuration software and the simulation software is only interrupted. The EASYSIM simulation application is not exited automatically (see below).

Exiting the EASYSIM simulation

To exit the EASYSIM simulation:

1. First exit simulation mode in the configuration software (deselect the "Simulate Safety Controller" button).
2. Then select "Exit" in the EASYSIM context menu (in the Windows taskbar) or click on "Exit" in the EASYSIM window.



If EASYSIM is exited while the "Simulate Safety Controller" button is activated in SAFECONF, EASYSIM restarts automatically after being exited.

Additional information about operating EASYSIM

For additional information about the EASYSIM controller simulation, please refer to the "EASYSIM controller simulation" section in the online help for the SAFECONF configuration software:

- Operating EASYSIM
- Simulating time sequences in EASYSIM expert mode
- Status of the EASYSIM simulation

5 Configuration and startup

5.1 Configuration overview from A to Z

The diagram below describes the simplified sequence, i.e., the general procedure, for developing a configuration project and for starting up the PSR-TRISAFE-S safety module. For detailed information, please refer to the specified sections and the SAFECONF online help.

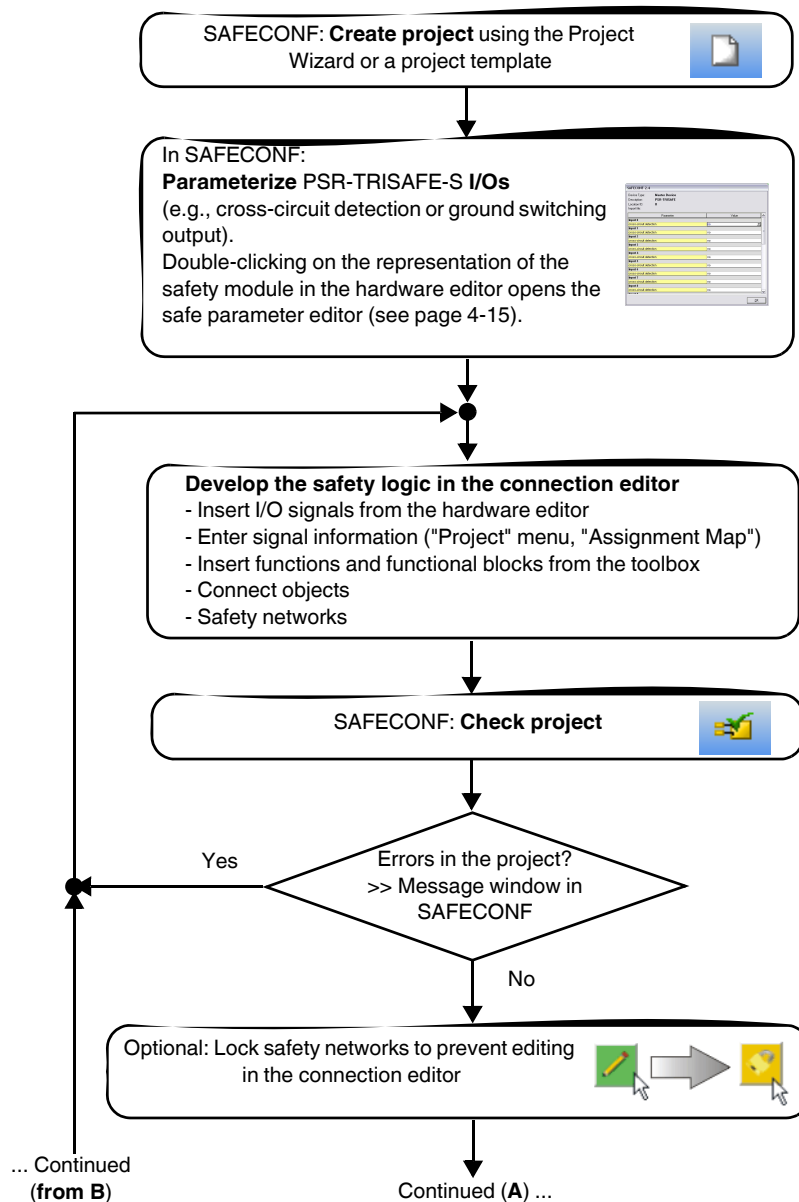

Figure 5-1 Flowchart: Configuration from A to Z (1 of 3)

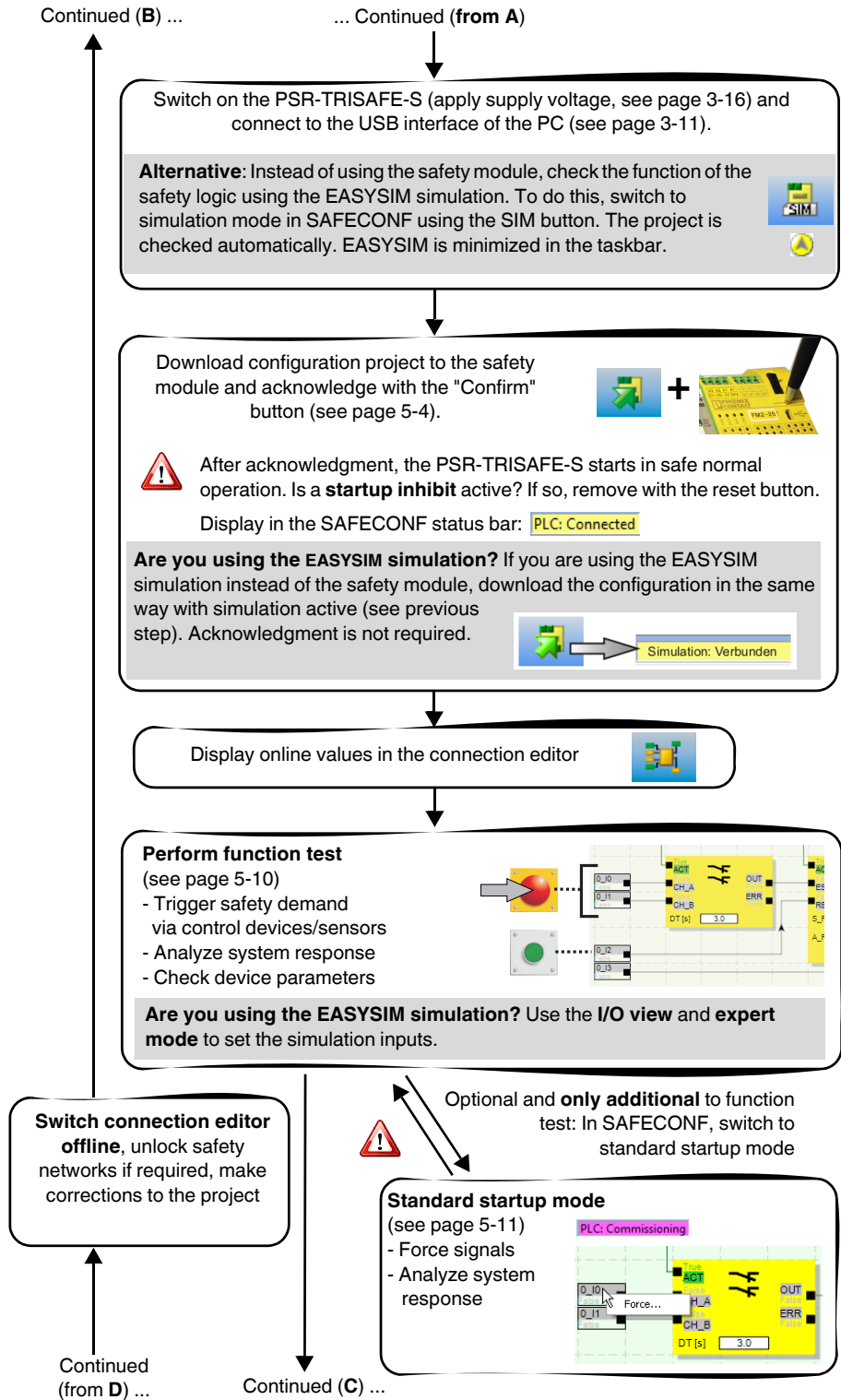

Figure 5-2 Flowchart: Configuration from A to Z (2 of 3)

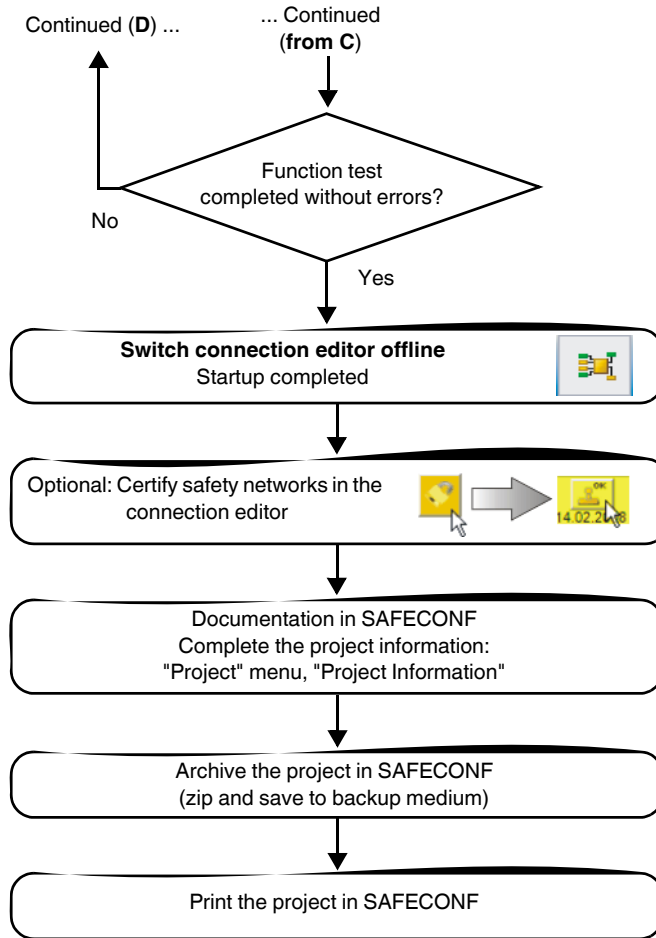

Figure 5-3 Flowchart: Configuration from A to Z (3 of 3)

5.2 Downloading the configuration from SAFECONF

**WARNING: Risk of damage due to unintentional/incorrect operations.**

Prior to startup, ensure that, if the safety module functions in an unintended or incorrect way, this will not cause damage.

The configuration, including the device parameterization, is created in the SAFECONF configuration software as a project and must be downloaded to the PSR-TRISAFE-S safety module once complete. This data is usually transmitted via the USB interface of the safety module.



Alternatively, the configuration can also be downloaded by inserting an IFS-CONFSTICK that contains the relevant data. Please refer to "Downloading the configuration using the IFS-CONFSTICK" on page 5-7.

1. Ensure that:
 - The PSR-TRISAFE-S safety module is switched on.
 - The SAFECONF configuration software is installed on the configuration computer (this installation also includes the required drivers).
 - The SAFECONF configuration software is started.
 - An IFS-CONFSTICK is inserted in the safety module. Otherwise the configuration cannot be downloaded.
2. Connect the USB cable to the PSR-TRISAFE-S safety module (mini-USB connector, 5-pos., maximum cable length 3 m) and to a USB port on the PC.

**NOTE: Electrostatic discharge**

The PSR-TRISAFE-S safety module contains components that can be damaged or destroyed by electrostatic discharge. When handling the USB interface, observe the necessary safety precautions against electrostatic discharge (ESD) according to EN 61340-5-1 and EN 61340-5-2.

Once the connecting cable has been connected, the correspondingly configured PC detects the safety module automatically and indicates the safety module status at the bottom right in the status bar (see Figure 4-1 on page 4-3).



Figure 5-4 USB connection between PC and safety module

3. The project can only be downloaded to the PSR-TRISAFE-S safety module if you have logged on in SAFECONF with the correct **controller password**. In the "Safe Controller" menu, select "Log On", enter the controller password in the dialog box and click "OK".
4. Provided that the current project has been checked and has **no errors** (see page 4-18 or the SAFECONF online help), the project loaded in SAFECONF can be downloaded to the safety module by clicking on the following icon in the toolbar:



Is there already a project on the safety module?

If the status bar has a yellow entry on the right "Controller: No project", the project is transmitted to the safety module without any further prompts.

If another project or another version of the same project is already available on the safety module and is being executed, a corresponding dialog box appears, indicating this fact. Click "Yes" in this message dialog box to overwrite the current controller configuration on the safety module.

During data transmission

- A progress indicator is displayed in the SAFECONF status bar.
- The "CONF" status indicator flashes quickly on the PSR-TRISAFE-S safety module (approximately 6 Hz).



If the data transmission is interrupted during the download, please refer to "Problems and solutions" on page 7-1.

5. Once data transmission has been completed successfully, the "CONF" status indicator flashes slowly (approximately 1.5 Hz) and a corresponding message dialog box appears in the configuration software.

Do not confirm this message yet, first complete the following step.



Please note:

First acknowledge the configuration on the safety module (see step 6.) ...

... before clicking "OK".

Figure 5-5 Message dialog box following successful data transmission

- Confirm the new configuration by pressing the "Confirm" button using a pen (see Figure 5-6).



WARNING: Risk due to activated outputs.

Following the confirmation described in this step, the safety module starts running immediately. Provided that no startup inhibit, which must be cancelled manually, is active, outputs may be activated immediately after startup. Make sure that the safety module startup will not lead to any hazardous situations.

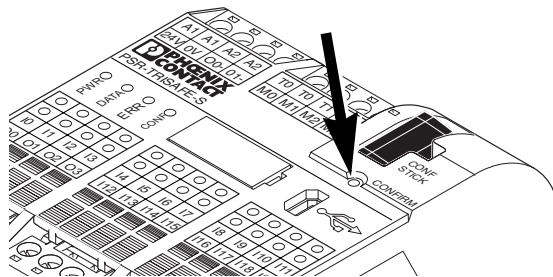

Figure 5-6 Confirming the configuration with the "Confirm" button

The safety module is then reinitialized (all status indicators are on briefly) and then switches to safe normal operation (only "PWR" LED on).



Startup inhibit active?

If a startup inhibit has been predefined in the configuration, it will now be active following startup. An active startup inhibit must be cancelled by pressing a reset button which is connected to the safety module according to the configuration.

For additional information, please refer to "System startup and restart behavior" on page 2-5.



If the safety module is not initialized correctly, proceed as described in "Problems and solutions" on page 7-1.

Next steps

Next, continue with the function test (see "Function test" on page 5-10).



Check values (CRC): To ensure that any distortions to the configuration data during transmission to the safety module can be reliably detected, a check value (CRC) is calculated in the configuration software when the project is checked. The safety module also determines the check value for the downloaded data. If the check values on the safety module and in the configuration software are identical, all data has been saved on the safety module without distortion. If the check values differ, a corresponding error message is output.

The check value (CRC) will also differ if **subsequent modifications** have been made to the project in the configuration software, but have not yet been downloaded to the safety module. A change to the product documentation can also modify the check value, for example.

5.3 Downloading the configuration using the IFS-CONFSTICK



WARNING: Risk of damage due to unintentional/incorrect operations.

Prior to startup, ensure that, if the safety module functions in an unintended or incorrect way, this will not cause damage.

Configurations can not only be downloaded via the USB interface, but can also be downloaded using the IFS-CONFSTICK. This is useful if no configuration computer is available at an installation location or for transferring the configuration to a new device on device replacement.

To replace the IFS-CONFSTICK, proceed as follows. This sequence ensures that the active configuration is not overwritten by accidental insertion of an IFS-CONFSTICK.

Removing the IFS-CONFSTICK

1. The IFS-CONFSTICK should not be replaced during operation. If the safety module is already running, proceed as follows:
 - a) First, shut down the machine.
 - b) Switch off the safety module.
 - c) Remove the current IFS-CONFSTICK.

Inserting the new IFS-CONFSTICK

2. Insert the new IFS-CONFSTICK in the safety module, which is switched off. The IFS-CONFSTICK is mechanically keyed and cannot be inserted in the device incorrectly.
3. Switch the safety module on and wait until it has initialized (all four status LEDs light up once during initialization).
The safety module now detects the previously unknown IFS-CONFSTICK and indicates this by making the "CONF" status LED flash.
4. Remove the IFS-CONFSTICK again.
5. Press the "Confirm" button on the device and **hold** it down.

- Reinsert the IFS-CONFSTICK **while** holding down the "Confirm" button.

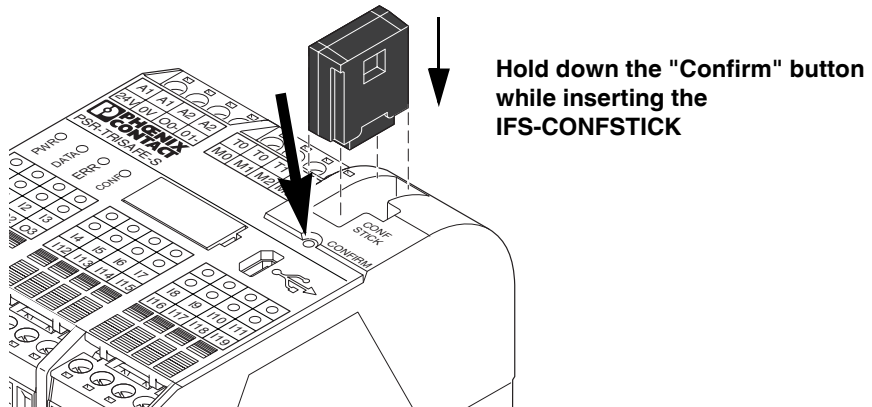

Figure 5-7 Pressing the "Confirm" button while inserting the IFS-CONFSTICK

- Release the "Confirm" button once the IFS-CONFSTICK is inserted correctly. The safety module now initializes with the new configuration.



WARNING: Risk due to activated outputs.

When the IFS-CONFSTICK is replaced, outputs may be activated. Once the configuration has been downloaded in this way, the safety module starts with the program execution. Provided that no startup inhibit, which must be cancelled manually, is active, outputs may be activated immediately. Make sure that the safety module startup will not lead to any hazardous situations.



Startup inhibit active?

If a startup inhibit has been predefined in the configuration, it will now be active following startup. An active startup inhibit must be cancelled by pressing a reset button which is connected to the safety module according to the configuration.

For additional information, please refer to "System startup and restart behavior" on page 2-5.



If the safety module is not initialized correctly, proceed as described in "Problems and solutions" on page 7-1.



When the IFS-CONFSTICK has been removed correctly, all of the safety module outputs are FALSE. While the IFS-CONFSTICK is not inserted, the safety module has no function. If the IFS-CONFSTICK is not removed correctly, the safety module also displays an error message.

5.4 Uploading the configuration from the PSR-TRISAFE-S safety module

A project which is downloaded to the PSR-TRISAFE-S safety module is saved there and can be uploaded to the PC and the configuration software again if required.

This may be required, for example, if a project has to be read from the safety module for diagnostic purposes.



It is possible to upload a project from the safety module to the configuration software without the controller password. However, to edit the uploaded project you will need the correct project password.

To upload the project, proceed as follows:

1. If a project is currently open in the configuration software, save it before uploading the required project from the safety module.
2. If necessary, exit startup mode and the online mode of the configuration software.
The "Online Values" icon must not be selected prior to starting the upload and the status bar must show the controller status "Controller: Connected".
3. Click on the "Upload" icon in the toolbar:



4. Click "Yes" in the prompt dialog box that appears to confirm the upload.
5. Transmission from the safety module to the PC starts and a progress indicator is displayed in the SAFECONF status bar.
6. If a project with the same name as the project which has just been uploaded already exists on the PC, a prompt will appear where you must decide whether you want to overwrite the project which is already loaded or not.
In this prompt dialog box, click:
 - "Yes" to overwrite the data of the existing project with that of the project which has just been uploaded.
Overwriting means that the current data will be lost and it will not be possible to recover it.
 - "No" to save the uploaded project under a different name or in a different directory.
The "Save Project As" dialog box appears. Here, select a directory, enter a file name, and click on "Save".
7. You are now asked to enter the project password.
Once you have entered the password you can edit and check the project, load it to the safety module, and start it up there as usual.

5.5 Function test

Validation

Once the project has been loaded onto the PSR-TRISAFE-S safety module and executed from this point (following manual confirmation), you must perform a function test to ensure that the safety module is working correctly and, therefore, that the safety logic and all the cabling are working correctly as well.

Online mode in SAFECONF

To support you in this, you can switch the SAFECONF configuration software to online mode so that online values can be read cyclically from the safety module and displayed in the connection editor and the hardware editor.

Safety demand/monitoring signals

Once a safety demand has been triggered by activating the safe control devices, e.g., by pressing the emergency stop control device or opening the safety door, the behavior of the safety logic can be analyzed precisely in the configuration software, as in online mode the connection editor displays the value of every signal "live".



WARNING: Risk of injury or damage to equipment due to unintentional system states or incorrect responses.

Make sure that the act of triggering the safety demand will not pose a risk for people or materials.

The safety module is in the startup phase, i.e., unintentional system states or incorrect responses cannot be ruled out.

Do not enter any hazardous areas and ensure that no other persons can access the danger zone either.

To execute a function test, proceed as follows:

Connected/logged on

1. Connect the PSR-TRISAFE-S safety module, which is switched on, to the configuration computer via the USB interface, start the SAFECONF configuration software, and log on for the safety module.

The status bar in SAFECONF displays the following entry on the right-hand side.

PLC: Logged on **PLC: Connected**

2. Switch SAFECONF to online mode by clicking on the "Online Values" icon in the toolbar:



The system can only display online values if the project in the safety module and the project in the configuration system are identical. If you have made a change to a project after startup (even something as small as moving an object is classed as a change), you must check the project and send it to the safety module again before you can display online values.

"Signal lines" and functional block connections are now displayed in the connection editor in different colors, according to their state (TRUE/FALSE), and together with the current values. The hardware editor also supports the function test through "lit" LEDs.

- Now trigger a safety demand via the safe control devices. Monitor the response of the machine and the configuration in the connection editor, which has been switched to online mode.

Example:

Emergency stop not pressed, no safety demand

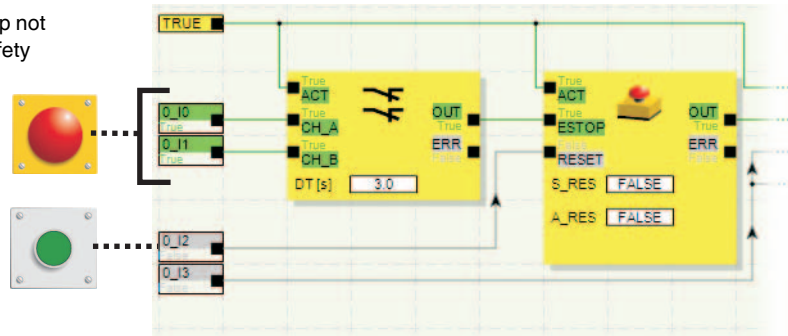

Safety demand

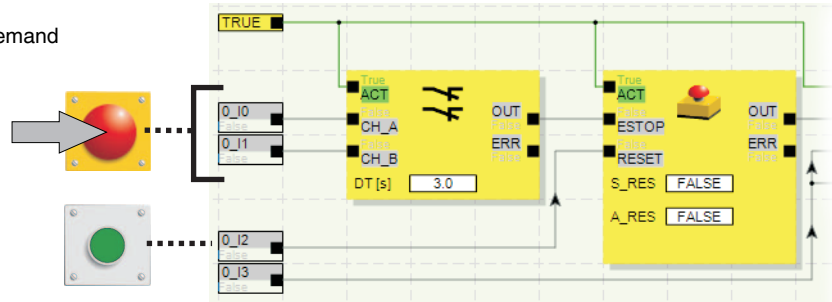

103503a011.eps

Figure 5-8 Example of a function test for the safety system using SAFECONF online mode

5.6 Startup mode

In addition to the mandatory function test using online mode (see "Function test" on page 5-10), startup mode can also be used.

For example, instead of pressing the emergency stop control device or opening the safety door, in startup mode you can force the signal corresponding to the safe control device in the connection editor.



WARNING: The test in startup mode does not replace the proper function test.

The test of the safety application using startup mode must not replace the proper function test using safe control devices. The test in startup mode may only be performed in addition to the standard function test, as a preliminary test, for example.

Forcing signals in the online display of the connection editor directly controls the safety module.



WARNING: Eliminate hazards

Before forcing any signals, ensure that doing so will not pose a risk for people or materials.



WARNING: Startup mode is a standard operating mode

As in online mode, the connection editor displays online values, which are read from the safety module. However, as signals can also be influenced in startup mode (which is not possible in online mode), startup mode is a standard operating mode.



Once the supplementary function test has been performed in startup mode, exit startup mode again. This resets forced signals.

Starting startup mode

1. In SAFECONF, select "Startup Mode" from the "Safe Controller" menu.
2. A message appears, alerting you to possible hazards. Click "Yes" in this dialog box to exit safe mode and switch to standard startup mode.



Time limit: You have 30 seconds to change the operating mode (i.e., to click "Yes"). After this time, a corresponding error message is displayed and "Startup Mode" must be selected again in the "Safe Controller" menu.

The pink background of the status field in the configuration software status bar indicates that the safety module is running in standard mode:

PLC: Commissioning

The connection editor still displays online values, i.e., signals and connections, which are TRUE if green and FALSE if gray. The hardware editor is also visible in online mode.

Forcing signals



WARNING: Eliminate hazards due to forcing

Be extremely careful when forcing signals with the safety module running. Forcing means that the safe configuration is executed with the values of the signals you have forced.

Alternatively, double-click on the signal with the left mouse button.

The "Force" dialog box opens.

4. The signal designation can be seen at the top of the dialog box. The value to be forced is determined automatically from the current signal value and set in the dialog box.

- Click on "Force" to force the corresponding signal to the set value.



WARNING: Eliminate hazards due to forcing

Before forcing any signals, ensure that doing so will not pose a risk for people or materials.

- A message dialog box appears, where you must expressly confirm the forcing procedure once more. Click "Yes" to continue.

The signal remains at the forced value until the forcing function is reset.

Resetting forcing

Right-click on the signal you want to reset and select the "Force" command from the context menu. The "Force" dialog box opens.

In this dialog box you can either reset just the forced signal that is currently selected or all forced signals.



If startup mode is exited while signals are forced, they will be reset.

Exiting startup mode

To exit startup mode, switch back to "normal" online mode, which will cause the safety module to run in a safe operating mode again.

- In the "Safe Controller" menu, select the highlighted "Startup Mode" menu item (when startup mode is active, the icon next to the menu item appears activated).
- A confirmation dialog box appears, where "Yes" should be clicked to exit startup mode. The yellow background of the status field on the right-hand side of the status bar indicates that the safety module is running in safe normal operation again.

6 Application examples

Functional block help: Application for each functional block

Application examples are available in the online help for the safe functional blocks.

The online help describes at least one typical application for each functional block and shows the safety logic configured in SAFECNF as well as the wiring of the PSR-TRISAFE-S safety module in the form of schematic views.

The online help also includes typical signal sequence diagrams, which illustrate the behavior of each functional block.

The following application examples are included in the online help for the functional blocks:

- Single-channel and two-channel emergency stop circuits.
- Single-channel and two-channel safety door monitoring, with and without locking.
- Mode selector switch selection with locking of the set operating mode and manual operating mode acknowledgment.
- Evaluation of a three-position enable switch with confirmation of the selected safe operating mode.
- Parallel muting with two sensors.
- Evaluation of a light curtain connected via a single channel.
- Type II and Type III two-hand control devices.

7 Problems and solutions

This section provides a list of possible problems, which may occur when working with the SAFECONF configuration software and the PSR-TRISAFE-S safety module. The action to be taken and the way in which the user must respond in order to solve the issue is described for each individual problem.

The following descriptions are divided into categories that relate to the different sections of the configuration software.

7.1 General

Table 7-1 Solutions for general problems

Problem	Solution
When the SAFECONF safe configuration software was launched, the installation check identified a faulty system file. A corresponding message window is displayed.	Uninstall the safe configuration software, then reinstall it by running the setup program from the installation CD.
The operating system test routine has identified that you are trying to launch the SAFECONF configuration software on an operating system that is not supported.	Install an operating system supported by SAFECONF (see "System requirements for the SAFECONF configuration software" on page 2-15) or consult the technical support team to find out whether a newer version of SAFECONF is available, which supports your current operating system.
An error has occurred (accompanied by a corresponding message), which cannot be removed using any of the measures described here.	Please contact our technical support team.
The SAFECONF safe configuration software or one of its functions is not behaving as described in the user documentation or the online help.	Please contact our technical support team.

7.2 Graphical connection editor

Table 7-2 Solutions for problems with the graphical connection editor

Problem	Solution
<p>You have attempted to open a project, but the safety logic could not be loaded due to a checksum error.</p> <p>A corresponding message window is displayed.</p>	<p>The project concerned is damaged and can no longer be used.</p> <p>Use the latest backup copy of the project (as described in the online help under "Zipping and extracting projects").</p> <p>If the problem persists, please contact our technical support team.</p>
<p>During editing, a message window appears where the connection editor reports damaged data, a sporadic error or a systematic error.</p>	<p>The project is closed automatically. You do not have the opportunity to save the most recently made changes.</p> <p>If the problem persists when the project is reopened, please contact our technical support team.</p>

7.3 Device parameterization editor

Table 7-3 Solutions for problems with the device parameterization editor

Problem	Solution
<p>You have attempted to open the device parameterization editor, but the data could not be loaded due to a checksum error.</p> <p>A corresponding message window is displayed.</p>	<p>The project can no longer be used, as the parameterization data cannot be deleted.</p> <p>Use the latest backup copy of the project (as described in the online help under "Zipping and extracting projects").</p>
<p>The device parameterization editor responds unexpectedly to an entry in the parameter table by displaying something other than what has been entered or selected, for example.</p> <p>This may be traced back to a sporadic error or a systematic error.</p>	<p>Undo the last entry (by pressing <Ctrl>+<Z>), then repeat the entry.</p> <p>If the result is still incorrect, please contact our technical support team.</p>
<p>During editing, a message window appears where the device parameterization editor reports damaged data, a sporadic error or a systematic error.</p>	<p>The project is closed automatically. You do not have the opportunity to save the most recently made changes.</p> <p>If the problem persists when the project is reopened, please contact our technical support team.</p>

7.4 Online communication between SAFECNF and the PSR-TRISAFE-S safety module

Table 7-4 Solutions for communication problems

Problem	Solution
<p>A connection cannot be established to the safety module.</p> <p>The status bar does not display a status for the safety module ("Timeout", "No project" or "Connected"; see information under the diagram below).</p> <p>The status bar looks like this, for example:</p> 	<p>Proceed as follows:</p>  <p>* Possible module status on existing connection:</p> <ul style="list-style-type: none">  Controller: Timeout — Temporary during initialization  Controller: No project — Download project  Controller: Connected — Start function test <p style="text-align: right;">103503a019.eps</p>

Table 7-4 Solutions for communication problems

Problem	Solution
<p>Transmission has been interrupted during the download procedure.</p>	<ol style="list-style-type: none"> 1. Start transmission again. 2. If the download procedure fails once more, remove the USB connecting cable from the interface on the configuration computer and reinsert it. 3. Once the safety module has been detected correctly (see display in the status bar), restart the download procedure.
<p>Following successful project download, the SAFECNF safe configuration software identifies that the checksum of the project on the safety module does not match that of the project on the PC. A corresponding message window is displayed.</p>	<p>Proceed as follows:</p> <pre> graph TD A[Download the project to the safety module again and acknowledge by pressing the "Confirm" button.] --> B{Checksum error still indicated?} B -- No --> C[No further action required. You can start the function test.] B -- Yes --> D[Download the project to another safety module that is not currently in use.] D --> E{Checksum error still indicated?} E -- No --> F[Use this safety module instead of the one used first.] E -- Yes --> G[Please contact our technical support team.] </pre> <p style="text-align: right;">103503a020.eps</p>

7.5 Safety module messages

Table 7-5 Solutions for PSR-TRISAFE-S safety module messages

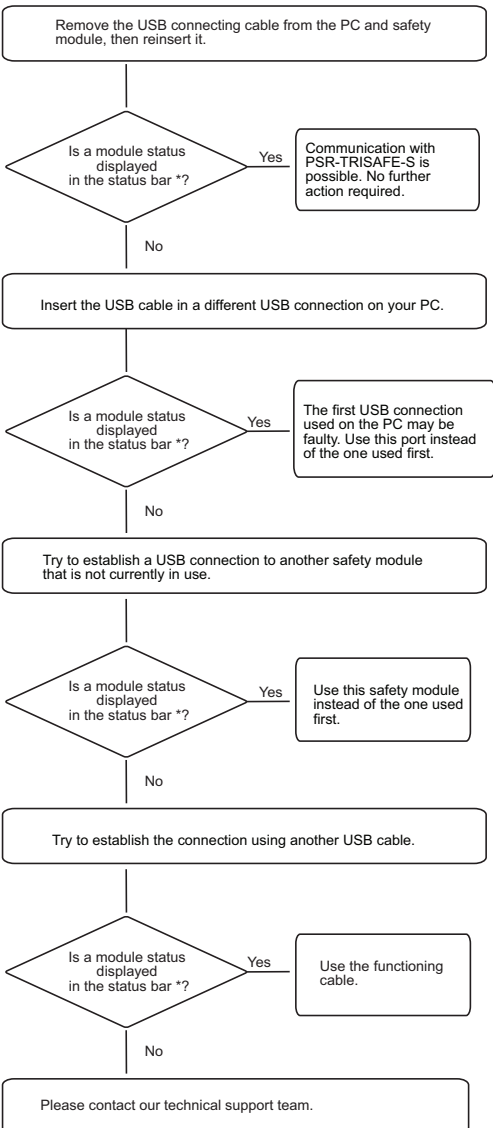
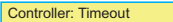
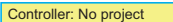
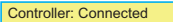
Problem	Solution
Following acknowledgment of the newly loaded configuration, the safety module is not initialized correctly ("Controller: Error" in the status bar and flashing "ERR" status indicator on the safety module).	<ol style="list-style-type: none"><li data-bbox="978 411 1406 464">1. Switch the safety module off and on again.<li data-bbox="978 474 1406 590">2. Download the project to the safety module again and acknowledge the new configuration by pressing the "Confirm" button on the device.<li data-bbox="978 600 1406 653">3. If the problem persists, please contact our technical support team.
The safety module reports an internal error.	Please contact our technical support team.

A Appendix

A.1 List of figures

Section 1

Figure 1-1: Calling the online help in the SAFECONF configuration software 1-8

Section 2

Figure 2-1: Typical structure of a safety system with PSR-TRISAFE-S 2-1

Figure 2-2: PSR TBUS DIN rail connector from Phoenix Contact 2-3

Figure 2-3: Implementing a startup inhibit, restart inhibit, and stop category 0 for safe output O0 2-7

Figure 2-4: Implementing cross-circuit detection for an emergency stop control device at inputs I0 and I1 of the safety module 2-8

Figure 2-5: Parameterizing cross-circuit detection for a module input 2-9

Figure 2-6: Simplified schematic view: Hardware diagnostics in the event of an error at a safe functional block 2-10

Figure 2-7: Simplified schematic view: Wiring check 2-11

Figure 2-8: Example of an online tool tip in the event of an error 2-12

Figure 2-9: Examples of tool tips in the connection editor in offline mode (while editing the safety logic) 2-12

Figure 2-10: Password protection for the PSR-TRISAFE-S and SAFECONF 2-13

Section 3

Figure 3-1: PSR-TRISAFE-S safety module with screw connection (left) or with spring-cage terminal blocks (right), on 35 mm EN DIN rail 3-1

Figure 3-2: Block diagram for the PSR-TRISAFE-S safety module 3-2

Figure 3-3: Diagram: Possible operating modes (status) for the PSR-TRISAFE-S safety module 3-3

Figure 3-4: Operating and indication elements of the PSR-TRISAFE-S safety module 3-4

Figure 3-5: PSR-TRISAFE-S signal connections 3-7

Figure 3-6: Example application for ground switching outputs O0- and O1- 3-10

Figure 3-7: Status bar in the SAFECONF configuration software (safety module already contains a configuration project) 3-11

Figure 3-8: IFS-CONFSTICK on the PSR-TRISAFE-S 3-12

Figure 3-9: Mounting PSR TBUS DIN rail connectors 3-14

Figure 3-10: Attaching the PSR-TRISAFE-S safety module to the DIN rail 3-14

Figure 3-11: Connecting the supply voltage at A1/A2 and 24V/0V 3-16

Figure 3-12: Connection to screw terminal blocks (left) and spring-cage terminal blocks (right) 3-17

Section 4

Figure 4-1:	SAFECONF user interface	4-3
Figure 4-2:	Safe functional blocks in the toolbox (excerpt)	4-5
Figure 4-3:	Project Wizard for creating a new configuration project, using a project template	4-10
Figure 4-4:	Inserting safe functional blocks and functions from the toolbox in the connection editor	4-11
Figure 4-5:	Opening the hardware editor with the auto-hide function enabled	4-12
Figure 4-6:	Inserting a signal in the connection editor	4-12
Figure 4-7:	Connecting objects using a line	4-14
Figure 4-8:	Connecting unconnected signals to functional blocks or functions using drag & drop	4-14
Figure 4-9:	Opening the device parameterization editor for all I/Os	4-15
Figure 4-10:	Opening the device parameterization editor for one specific I/O	4-15
Figure 4-11:	Opening the device parameterization editor via the context menu	4-16
Figure 4-12:	Modifying device parameters in the device parameterization editor	4-16
Figure 4-13:	Setting the device parameter for the use of ground switching output O0-	4-17
Figure 4-14:	Jumping to an error location in the safety logic from the message window when checking the configuration project	4-18
Figure 4-15:	Documenting signal assignment in the "Assignment Map" dialog box	4-19
Figure 4-16:	Simulation of the safety module in SAFECONF	4-21
Figure 4-17:	Icon for simulation mode, "not activated" and "activated"	4-22
Figure 4-18:	EASYSIM icon in the Windows taskbar	4-22

Section 5

Figure 5-1:	Flowchart: Configuration from A to Z (1 of 3)	5-1
Figure 5-2:	Flowchart: Configuration from A to Z (2 of 3)	5-2
Figure 5-3:	Flowchart: Configuration from A to Z (3 of 3)	5-3
Figure 5-4:	USB connection between PC and safety module	5-5
Figure 5-5:	Message dialog box following successful data transmission	5-6
Figure 5-6:	Confirming the configuration with the "Confirm" button	5-6
Figure 5-7:	Pressing the "Confirm" button while inserting the IFS-CONFSTICK	5-8
Figure 5-8:	Example of a function test for the safety system using SAFECONF online mode	5-11

A.2 Index

Numerics

35 mm DIN rail 3-14

A

Alarm outputs M0 - M3 3-1, 3-9, 4-13

Antivalent (safe functional block) 4-6

Application example

Application examples for the individual functional blocks 6-1

Cross-circuit detection 2-8

Ground switching outputs O0-, O1- 3-10

Restart inhibit 2-6

Startup inhibit 2-6

Stop category 0 2-6

Assignment list 4-2

Assignment list (SAFECONF) 4-19

C

Cable lengths to sensors/control devices 3-17

Category 4 according to DIN EN ISO 13849 1-4

Check values (CRC) 4-18, 4-20, 5-7

Checking and downloading the project 4-18, 5-1, 5-2, 5-5

Communication between the PSR-TRISAFE-S and SAFECONF 2-2, 3-11

Configuration project, see Project

Connecting objects in the connection editor 4-14

Connection editor 2-2, 2-11, 3-7, 4-3, 4-11, 5-1, 5-10, 7-2

Connections on the PSR-TRISAFE-S 3-7

Controller password, see Password protection

Creating a project 4-10, 5-1

Cross-circuit detection 1-2, 2-8, 3-8, 3-9, 4-13, 4-16

Cross-circuit protection 3-10

D

Device parameterization editor 2-8, 4-15, 7-2

Diagnostics

Hardware diagnostics 2-9

Online tool tips 2-12

Status indicators 2-12

Wiring check 2-11

DIN rail connector, see PSR-TBUS DIN rail connector

DIN rail, see 35 mm DIN rail

Directives 1-5

Documentation 1-8

Documenting the signal assignment of the project... 4-19

Downloading the configuration using the IFS-CONFSTICK 5-7

Downloading the project using the IFS-CONFSTICK. 5-7

Dual signals 3-7, 4-11, 4-13

E

EDM (safe functional block) 2-6, 4-6

Electrical safety 1-3

EMC Directive 2004/108/EC 1-5

EmergencyStop (safe functional block) 2-6, 4-6

EnableSwitch (safe functional block) 2-6, 4-6

Equivalent (safe functional block) 4-6

Error detection 1-2

ESPE (safe functional block) 2-6

Expert mode (EASYSIM simulation) 5-2

F

Forcing 3-11, 4-2, 4-21, 4-22, 5-2, 5-12

Forcing signals, see Forcing

Function test 5-2, 5-7, 5-10

Functional blocks with startup or restart inhibit 2-6

Functional blocks/functions, safe 1-7, 4-5, 6-1

Functions/functional blocks, safe 1-7, 4-5, 6-1

G

Ground switching outputs O0-, O1- 3-1, 3-10, 4-17

GuardLocking (safe functional block) 2-6, 4-7

GuardMonitoring (safe functional block) 2-6, 4-7

Guideline for test and certification GS-ET-26 1-5

H

Hardware diagnostics 2-9

Hardware editor . 2-8, 3-7, 4-2, 4-4, 4-11, 4-15, 5-1, 5-10

I

IFS-CONFSTICK 2-2, 3-6, 3-12, 5-4, 5-7

Downloading the configuration to the PSR-TRISAFE-S using IFS-CONFSTICK 5-7

Inserting functional blocks in the connection editor .. 4-11

Inserting functions in the connection editor 4-11

Inserting signal inputs and outputs in the connection editor
4-11

Intended use 1-7, 3-9

L

LEDs for inputs and outputs 3-6

Low Voltage Directive 2006/95/EC..... 1-5

M

Machinery Directive 2006/42/EC..... 1-5, 2-4

Machinery Directive 98/38/EC..... 1-5

Method of operation of the PSR-TRISAFE-S system . 2-1

MINI-SYS-PS system power supply unit 3-16

MINI-SYS-PS, system power supply unit 3-16

ModeSelector (safe functional block)..... 4-7

MutingPar (safe functional block) 4-8

MutingPar_2Sensor (safe functional block)..... 2-6, 4-8

MutingSeq (safe functional block) 4-8

O

Online help 6-1

 Call 1-8, 4-2, 4-9

Online tool tips in the connection editor..... 2-12

Outputs O0 - O3..... 3-1, 3-7, 3-8

P

Parameterization editor 4-15

Parameterizing inputs and outputs 4-15, 5-1

Password protection 2-13, 5-9

Performance level PLe according to DIN EN ISO 13849..
3-8

Personnel, requirements 1-1

Power supply for sensors and control devices 3-9

Printing parameters..... 4-17

Problems and solutions 7-1

Project configuration and startup, overview..... 5-1

Project documentation 4-19, 5-3

Project password, see Password protection

Project Wizard..... 4-10

PSR-TBUS DIN rail connector 3-4, 3-14, 3-16

 Module communication 2-3

PSR-TRISAFE-S..... 2-5

 "Confirm" button 3-6

 Alarm outputs M0 - M3 3-9

 Behavior with no IFS-CONFSTICK..... 3-12, 5-8

 Clock outputs T0, T1 2-8, 3-9

 Connecting the signal lines..... 3-17

 Connecting the supply voltage 3-16

 Connection terminal blocks 3-1

 Cross-circuit detection 2-8

 Diagnostic and status indicators..... 3-4

 Diagnostic tools..... 2-9

 Downloading the configuration using the IFS-
CONFSTICK 5-7

 Ground switching outputs O0-, O1- 3-10

 Hardware description 3-1

 I/O device error detection 2-8

 IFS-CONFSTICK, see IFS-CONFSTICK

 Installation 3-13

 LEDs for inputs and outputs 3-6

 Operating and indication elements..... 3-4

 Password protection..... 2-13

 Possible operating status 3-3

 Safe outputs O0 - O3..... 3-8

 Safety functions, possible..... 2-4

 Signal inputs..... 3-7

 Status indicators..... 2-12

 Supply outputs A1, A2 3-9

 Supply voltage via the MINI-SYS-PSI system power
supply unit 3-16

 System overview 2-1

 Uploading the project 5-9

 USB interface 3-11

 Using the system..... 2-4

PSR-TRISAFE-S confirm button 2-5, 3-4, 3-6, 5-2, 5-6, 5-7

PSR-TRISAFE-S connection terminal blocks.... 3-1, 3-17

PSR-TRISAFE-S diagnostic and status indicators 3-4

PSR-TRISAFE-S inputs 3-7

PSR-TRISAFE-S installation 3-13

PSR-TRISAFE-S mounting 3-13

PSR-TRISAFE-S operating and indication elements . 3-4

PSR-TRISAFE-S operating status 3-3

PSR-TRISAFE-S removal 3-15

PSR-TRISAFE-S signal inputs 3-7

PSR-TRISAFE-S status indicators 2-12, 3-4

PSR-TRISAFE-S supply voltage 3-16

PSR-TRISAFE-S system description 2-1

-
- Purpose of this manual..... 1-1
- Q**
- Qualifications for personnel..... 1-1
- R**
- Repairs 1-2
- Requirements for personnel..... 1-1
- Restart inhibit 1-2, 2-5, 2-7
- Risk analysis 1-4
- S**
- Safe functional blocks and functions 4-5
- Safe outputs, see Outputs O0 - O3
- SAFECONF 2-2
- Assignment list 4-19
 - Checking and downloading the project..... 4-18, 5-5
 - Configuring cross-circuit detection for inputs..... 4-16
 - Configuring the use of a ground switching output 4-17
 - Connection editor 4-3, 4-11
 - Creating a project 4-10
 - Device parameterization editor 2-8, 4-15
 - Documenting the signal assignment of the project 4-19
 - Functions and features 4-1
 - Hardware editor, see Hardware editor
 - Installing the software 4-1
 - Modifying device parameters 4-16
 - Online tool tips..... 2-12
 - Operation 4-10
 - Printing parameters 4-17
 - Project Wizard 4-10
 - Simulation mode..... 4-21
 - Starting up the project 4-18, 5-6
 - Status bar, see SAFECONF status bar
 - System requirements 2-15
 - Toolbox 4-3
 - User interface 4-3
- SAFECONF checklist..... 4-2
- SAFECONF documentation..... 4-2
- SAFECONF online mode 4-2, 5-2, 5-9, 5-10
- SAFECONF status bar 3-11, 4-4, 5-2, 5-5, 5-9, 5-10, 5-12
- Safety concept 1-4
- Safety integrity 1-4, 1-7
- Safety notes
- Electrical 1-3
 - General 1-1
 - Safety of the machine/system 1-4
- Safety of personnel and equipment..... 1-2
- Safety of the machine/system 1-4
- Safety requirements 1-4
- Screw connections..... 3-1, 3-17
- Signal assignment..... 4-2
- Signal sequence diagrams for functional blocks 6-1
- SIL 3 according to DIN EN 61508 1-4
- SILCL 3 according to DIN EN 62061 1-4
- Simulation 4-21, 5-2
- Software system requirements..... 2-15
- Solutions for problems 7-1
- Spring-cage connections 3-1, 3-17
- Standards
- DIN EN 1088 1-6, 4-7
 - DIN EN 50254 1-6
 - DIN EN 574 1-6
 - DIN EN 60204 1-5, 2-2, 2-4, 4-6
 - DIN EN 61131 1-6
 - DIN EN 61496 1-6
 - DIN EN 61508 1-4, 1-5, 1-7
 - DIN EN 62061 1-4, 1-5, 1-7
 - DIN EN 953 1-6
 - DIN EN ISO 13849 1-4, 1-5, 1-7, 3-8
 - EC/ISO 7498 1-6
 - EN 50178 1-6
 - EN 954 1-5, 3-8
 - EN ISO 12100 1-5
 - EN ISO 13850 1-6
 - IEC 62061 1-5
- Starting up the project..... 4-18, 5-6
- Startup inhibit 1-2, 2-5, 2-7, 5-2, 5-6, 5-8
- Startup mode 2-11, 4-2, 5-2, 5-9, 5-11, 5-12
- Startup/restart behavior 1-2, 2-5
- Stop category 0..... 2-2, 2-4, 2-7
- Supply outputs A1, A2 3-9
- T**
- TBUS 2-3, 2-12, 3-4, 3-13, 3-14, 3-16
- Test pulses T0, T1 2-8, 3-1, 3-8, 3-9, 4-13, 4-16
- TestableSafetySensor (safe functional block)..... 2-6, 4-9
- Time limit when changing operating mode 5-12
- Toolbox 4-3, 4-11

PSR-TRISAFE-S

TwoHandControlTypell (safe functional block) 4-9
TwoHandControlTypelll (safe functional block) 4-9

U

Uploading the configuration from the PSR-TRISAFE-S....
5-9
Uploading the project from the PSR-TRISAFE-S 5-9
USB interface 2-2, 3-11, 5-4, 5-7
Use, intended 1-7, 3-9

W

Wiring check 2-11
Wiring documentation 4-19

Данный компонент на территории Российской Федерации

Вы можете приобрести в компании MosChip.

Для оперативного оформления запроса Вам необходимо перейти по данной ссылке:

<http://moschip.ru/get-element>

Вы можете разместить у нас заказ для любого Вашего проекта, будь то серийное производство или разработка единичного прибора.

В нашем ассортименте представлены ведущие мировые производители активных и пассивных электронных компонентов.

Нашей специализацией является поставка электронной компонентной базы двойного назначения, продукции таких производителей как XILINX, Intel (ex.ALTERA), Vicor, Microchip, Texas Instruments, Analog Devices, Mini-Circuits, Amphenol, Glenair.

Сотрудничество с глобальными дистрибьюторами электронных компонентов, предоставляет возможность заказывать и получать с международных складов практически любой перечень компонентов в оптимальные для Вас сроки.

На всех этапах разработки и производства наши партнеры могут получить квалифицированную поддержку опытных инженеров.

Система менеджмента качества компании отвечает требованиям в соответствии с ГОСТ Р ИСО 9001, ГОСТ РВ 0015-002 и ЭС РД 009

Офис по работе с юридическими лицами:

105318, г.Москва, ул.Щербаковская д.3, офис 1107, 1118, ДЦ «Щербаковский»

Телефон: +7 495 668-12-70 (многоканальный)

Факс: +7 495 668-12-70 (доб.304)

E-mail: info@moschip.ru

Skype отдела продаж:

moschip.ru

moschip.ru_4

moschip.ru_6

moschip.ru_9