

# KAI-43140

## 8040 (X) x 5360 (V) Interline CCD Image Sensor

### Description

The KAI-43140 image sensor is a 43 megapixel Interline Transfer CCD in a 35 mm optical format. Leveraging a 4.5  $\mu\text{m}$  pixel design that provides a 50% resolution increase compared to the KAI-29050 and KAI-29052 devices, the KAI-43140 provides excellent image uniformity and broad dynamic range. A flexible output architecture supports 1, 2, or 4 outputs for full resolution readout of up to 4 frames per second, and a true electronic shutter enables image capture without motion artifacts across a broad range of exposure times.

In addition to standard monochrome and Bayer Color configurations, the sensor is available in a Sparse CFA configuration which provides a 2x improvement in light sensitivity compared to the standard Bayer Color part. The sensor shares the same package as the KAI-29050 and KAI-29052 image sensors, simplifying camera design.

**Table 1. GENERAL SPECIFICATIONS**

Parameter	Typical Value
Architecture	Interline CCD; Progressive Scan
Total Number of Pixels	8160 (H) x 5480 (V)
Number of Effective Pixels	8080 (H) x 5400 (V)
Number of Active Pixels	8040 (H) x 5360 (V)
Pixel Size	4.5 $\mu\text{m}$ (H) x 4.5 $\mu\text{m}$ (V)
Active Image Size	36.18 mm (H) x 24.12 mm (V) 43.48 mm (Diag.), 35 mm Optical Format
Aspect Ratio	3:2
Number of Outputs	1, 2, or 4
Charge Capacity	13,000 electrons
Output Sensitivity	42 $\mu\text{V}/\text{e}^-$
Quantum Efficiency Pan (-AXA, -QXA) R, G, B (-FXA, -QXA)	45 % 27%, 34%, 37%
Read Noise (f = 60 MHz)	13 electrons rms
Dark Current Photodiode VCCD	7 electrons/s 50 electrons/s
Dynamic Range	60 dB
Charge Transfer Efficiency	0.999999
Blooming Suppression	> 300 X
Smear	-98 dB
Image Lag	< 10 electrons
Maximum Pixel Clock Speed	60 MHz
Maximum Frame Rates Quad Output Dual Output Single Output	4 fps 2 fps 1 fps
Package	72 pin PGA
Cover Glass	AR Coated, 2 Sides

NOTE: All parameters are specified at T = 40°C unless otherwise noted.



**ON Semiconductor®**

[www.onsemi.com](http://www.onsemi.com)



**Figure 1. KAI-43140 CCD Image Sensor**

### Features

- High Resolution Image Capture in 35 mm Optical Format
- True Electronic Shutter with Broad Exposure Latitude
- Low Noise Architecture
- Excellent Smear Performance
- Monochrome, Bayer Color, and Sparse CFA Configurations

### Applications

- Industrial Imaging and Inspection
- Security and Surveillance

### ORDERING INFORMATION

See detailed ordering, marking and shipping information on page 2 of this data sheet.

# KAI-43140

## ORDERING INFORMATION

Table 2. ORDERING INFORMATION

Part Number	Description	Marking Code
KAI-43140-AXA-JD-B1	Monochrome, Special Microlens, PGA Package, Sealed Clear Cover Glass with AR coating (both sides), Grade 1	KAI-43140-AXA Serial Number
KAI-43140-AXA-JD-B2	Monochrome, Special Microlens, PGA Package, Sealed Clear Cover Glass with AR coating (both sides), Grade 2	
KAI-43140-AXA-JD-AE	Monochrome, Special Microlens, PGA Package, Sealed Clear Cover Glass with AR coating (both sides), Engineering Grade	
KAI-43140-AXA-JP-B1	Monochrome, Special Microlens, PGA Package, Taped Clear Cover Glass (no coatings), Grade 1	KAI-43140-AXA Serial Number
KAI-43140-AXA-JP-B2	Monochrome, Special Microlens, PGA Package, Taped Clear Cover Glass (no coatings), Grade 2	
KAI-43140-AXA-JP-AE	Monochrome, Special Microlens, PGA Package, Taped Clear Cover Glass (no coatings), Engineering Grade	
KAI-43140-FXA-JD-B1	Gen2 Color (Bayer RGB), Special Microlens, PGA Package, Sealed Clear Cover Glass with AR coating (both sides), Grade 1	KAI-43140-FXA Serial Number
KAI-43140-FXA-JD-B2	Gen2 Color (Bayer RGB), Special Microlens, PGA Package, Sealed Clear Cover Glass with AR coating (both sides), Grade 2	
KAI-43140-FXA-JD-AE	Gen2 Color (Bayer RGB), Special Microlens, PGA Package, Sealed Clear Cover Glass with AR coating (both sides), Engineering Grade	
KAI-43140-QXA-JD-B1	Gen2 Color (Sparse CFA), Special Microlens, PGA Package, Sealed Clear Cover Glass with AR coating (both sides), Grade 1	KAI-43140-QXA Serial Number
KAI-43140-QXA-JD-AE	Gen2 Color (Sparse CFA), Special Microlens, PGA Package, Sealed Clear Cover Glass with AR coating (both sides), Engineering Grade	

See the ON Semiconductor *Device Nomenclature* document (TND310/D) for a full description of the naming convention used for image sensors. For reference documentation, including information on evaluation kits, please visit our web site at [www.onsemi.com](http://www.onsemi.com).

**DEVICE DESCRIPTION**

**Architecture**

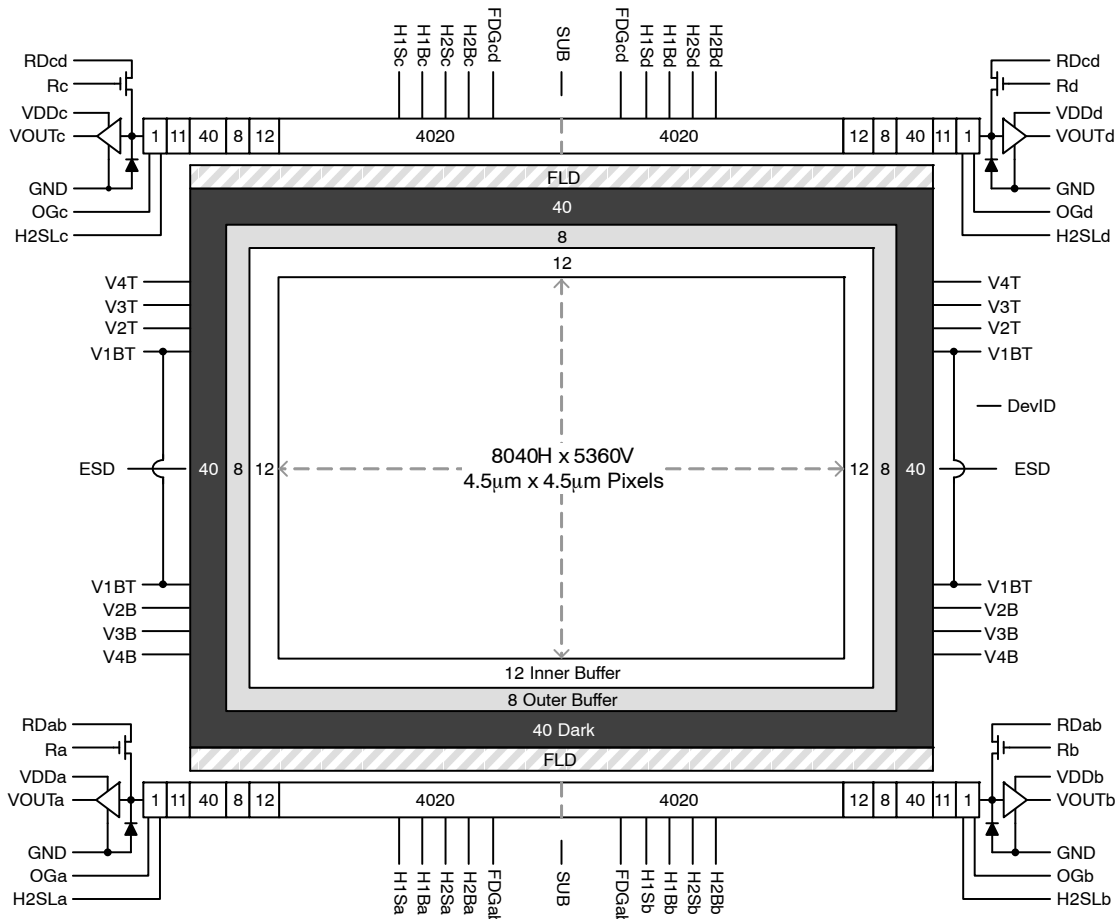

**Figure 2. Block Diagram**

**Dark Reference Pixels**

There are 40 dark reference rows at the top and 40 dark rows at the bottom of the image sensor. The dark rows are not entirely dark and so should not be used for a dark reference level. Use the 40 dark columns on the left or right side of the image sensor as a dark reference. Under normal circumstances use only the center 38 columns of the 40 column dark reference due to potential light leakage.

**Dummy Pixels**

Within each horizontal shift register there are 12 leading additional shift phases. These pixels are designated as dummy pixels and should not be used to determine a dark reference level. In addition, there is one dummy row of pixels at the top and bottom of the image.

**Active Buffer Pixels**

20 unshielded pixels adjacent to any leading or trailing dark reference regions are classified as active buffer pixels. These pixels are light sensitive but are not tested for defects and non-uniformities. The 8 outer buffer pixels are less

sensitive than the inner buffer pixels. The inner buffer pixels have the same sensitivity as the 8040 by 5360 active pixels.

**Image Acquisition**

An electronic representation of an image is formed when incident photons falling on the sensor plane create electron-hole pairs within the individual silicon photodiodes. These photoelectrons are collected locally by the formation of potential wells at each photo-site. Below photodiode saturation, the number of photoelectrons collected at each pixel is linearly dependent upon light level and exposure time and non-linearly dependent on wavelength. When the photodiodes charge capacity is reached, excess electrons are discharged into the substrate to prevent blooming.

**ESD Protection**

Adherence to the power-up and power-down sequence is critical. Failure to follow the proper power-up and power-down sequences may cause damage to the sensor. See Power-Up and Power-Down Sequence section.

# KAI-43140

## Bayer Color Filter

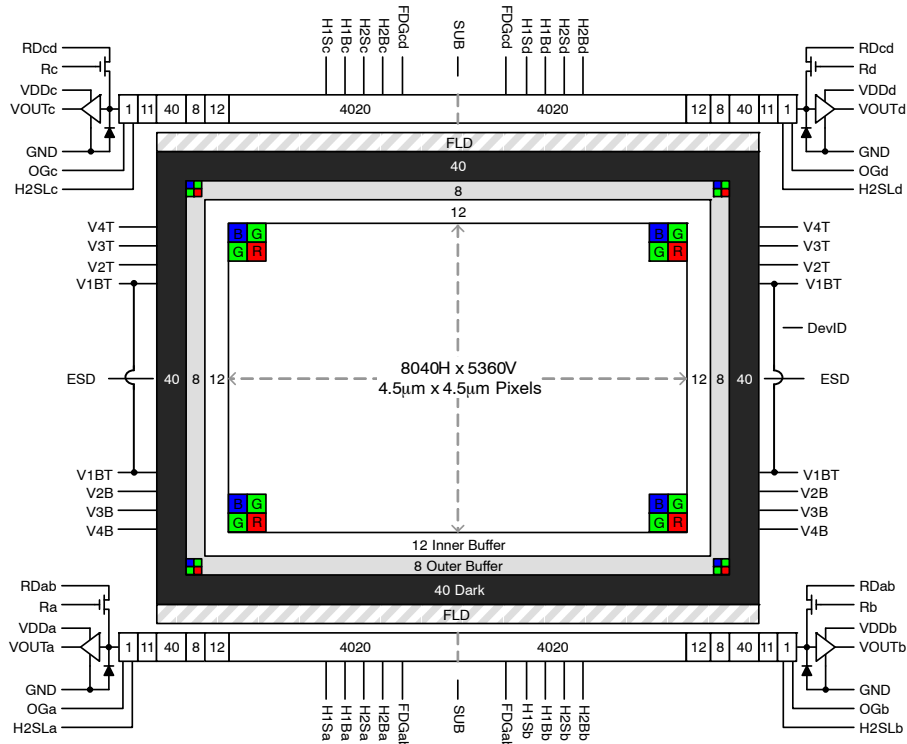

Figure 3. Bayer Color Filter Pattern

## Sparse Color Filter

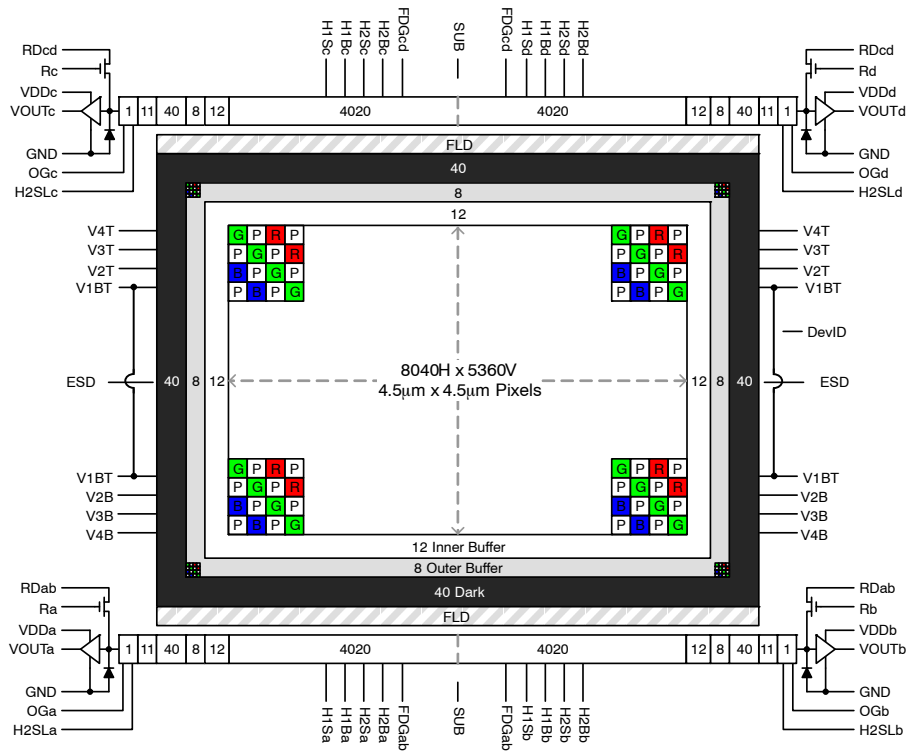

Figure 4. Sparse Color Filter Pattern

PHYSICAL DESCRIPTION

Pin Description and Device Orientation

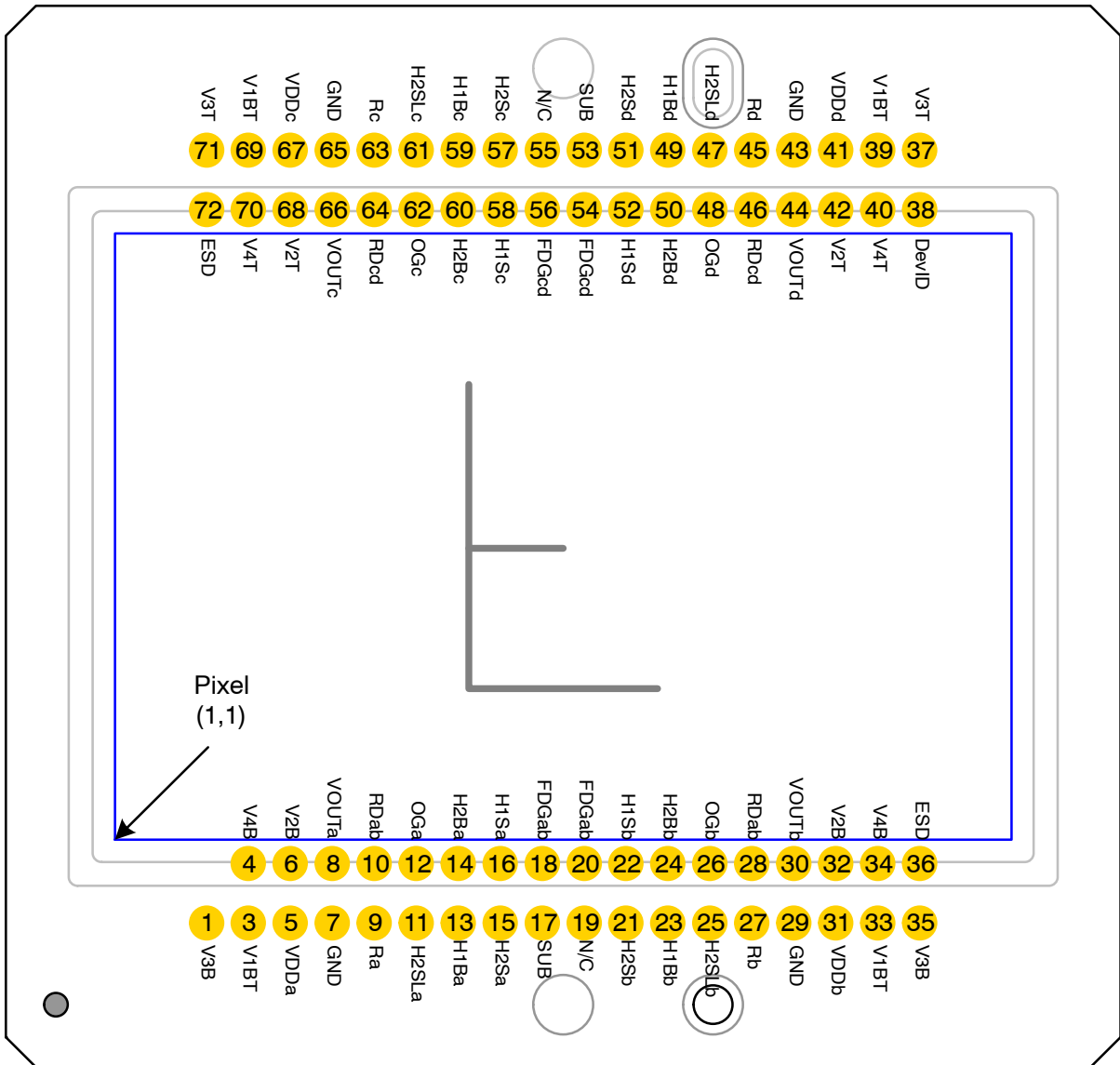

Figure 5. Package Pin Description – Top View

Table 3. PIN DESCRIPTION

Pin	Name	Description
1	V3B	Vertical CCD Clock, Phase 3, Bottom
3	V1BT	Vertical CCD Clock, Phase 1, Bottom and Top
4	V4B	Vertical CCD Clock, Phase 4, Bottom
5	VDDa	Output Amplifier Supply, Quadrant a
6	V2B	Vertical CCD Clock, Phase 2, Bottom
7	GND	Ground
8	VOUa	Video Output, Quadrant a
9	Ra	Reset Gate, Quadrant a
10	RDab	Reset Drain, Quadrants a and b
11	H2SLa	Horizontal CCD Clock, Phase 2, Storage, Last Phase, Quadrant a
12	OGa	Output Gate, Quadrant a
13	H1Ba	Horizontal CCD Clock, Phase 1, Barrier, Quadrant a
14	H2Ba	Horizontal CCD Clock, Phase 2, Barrier, Quadrant a
15	H2Sa	Horizontal CCD Clock, Phase 2, Storage, Quadrant a
16	H1Sa	Horizontal CCD Clock, Phase 1, Storage, Quadrant a
17	SUB	Substrate
18	FDGab	Fast Line Dump Gate, Bottom
19	N/C	No Connect
20	FDGab	Fast Line Dump Gate, Bottom
21	H2Sb	Horizontal CCD Clock, Phase 2, Storage, Quadrant b
22	H1Sb	Horizontal CCD Clock, Phase 1, Storage, Quadrant b
23	H1Bb	Horizontal CCD Clock, Phase 1, Barrier, Quadrant b
24	H2Bb	Horizontal CCD Clock, Phase 2, Barrier, Quadrant b
25	H2SLb	Horizontal CCD Clock, Phase 2, Storage, Last Phase, Quadrant b
26	OGb	Output Gate, Quadrant b
27	Rb	Reset Gate, Quadrant b
28	RDab	Reset Drain, Quadrants a and b
29	GND	Ground
30	VOUa	Video Output, Quadrant a
31	VDDb	Output Amplifier Supply, Quadrant b
32	V2B	Vertical CCD Clock, Phase 2, Bottom
33	V1BT	Vertical CCD Clock, Phase 1, Bottom and Top
34	V4B	Vertical CCD Clock, Phase 4, Bottom
35	V3B	Vertical CCD Clock, Phase 3, Bottom
36	ESD	ESD Protection Disable
37	V3T	Vertical CCD Clock, Phase 3, Top
38	DevID	Device Identification
39	V1BT	Vertical CCD Clock, Phase 1, Bottom and Top
40	V4T	Vertical CCD Clock, Phase 4, Top
41	VDDd	Output Amplifier Supply, Quadrant d
42	V2T	Vertical CCD Clock, Phase 2, Top

# KAI-43140

**Table 3. PIN DESCRIPTION** (continued)

Pin	Name	Description
43	GND	Ground
44	VOUtd	Video Output, Quadrant d
45	Rd	Reset Gate, Quadrant d
46	RDcd	Reset Drain, Quadrants c and d
47	H2SLd	Horizontal CCD Clock, Phase 2, Storage, Last Phase, Quadrant d
48	OGd	Output Gate, Quadrant b
49	H1Bd	Horizontal CCD Clock, Phase 1, Barrier, Quadrant d
50	H2Bd	Horizontal CCD Clock, Phase 2, Barrier, Quadrant d
51	H2Sd	Horizontal CCD Clock, Phase 2, Storage, Quadrant d
52	H1Sd	Horizontal CCD Clock, Phase 1, Storage, Quadrant d
53	SUB	Substrate
54	FDGcd	Fast Line Dump Gate, Top
55	N/C	No Connect
56	FDGcd	Fast Line Dump Gate, Top
57	H2Sc	Horizontal CCD Clock, Phase 2, Storage, Quadrant c
58	H1Sc	Horizontal CCD Clock, Phase 1, Storage, Quadrant c
59	H1Bc	Horizontal CCD Clock, Phase 1, Barrier, Quadrant c
60	H2Bc	Horizontal CCD Clock, Phase 2, Barrier, Quadrant c
61	H2SLc	Horizontal CCD Clock, Phase 2, Storage, Last Phase, Quadrant c
62	OGc	Output Gate, Quadrant c
63	Rc	Reset Gate, Quadrant c
64	RDcd	Reset Drain, Quadrants c and d
65	GND	Ground
66	VOUtc	Video Output, Quadrant c
67	VDDc	Output Amplifier Supply, Quadrant c
68	V2T	Vertical CCD Clock, Phase 2, Top
69	V1BT	Vertical CCD Clock, Phase 1, Bottom and Top
70	V4T	Vertical CCD Clock, Phase 4, Top
71	V3T	Vertical CCD Clock, Phase 3, Top
72	ESD	ESD Protection Disable

1. Like named pins are internally connected and should have a common drive signal.
2. N/C pins (19, 55) should be left floating

**IMAGING PERFORMANCE**

**Table 4. TYPICAL OPERATION CONDITIONS**

(Unless otherwise noted, the Imaging Performance Specifications are measured using the following conditions.)

Description	Condition	Notes
Light Source	Continuous Red, Green and Blue LED Illumination	For monochrome sensor, only green LED used
Operation	Nominal operating voltages and timing	

**Table 5. PERFORMANCE PARAMETERS** (Performance parameters are by design.)

Description	Symbol	Nom.	Units	Notes	
Maximum Photo-response Nonlinearity	NL	2	%	4	
Maximum Signal Error due to Nonlinearity Differences	$\Delta NL$	1	%	4	
Horizontal CCD Charge Capacity	HNe	40	ke-		
Vertical CCD Charge Capacity	VNe	24	ke-		
Photodiode Charge Capacity	PNe	13	ke-	5	
Image Lag	Lag	< 10	e-		
Anti-blooming Factor	Xab	> 300X			
Vertical Smear	Smr	-98	dB	9	
Read Noise	$n_{e-T}$	13	e-rms	6	
Dynamic Range	DR	60	dB	6, 7	
Output Amplifier DC Offset	Vodc	8	V		
Output Amplifier Bandwidth	f-3db	250	MHz	8	
Output Amplifier Impedance	Rout	127	$\Omega$		
Output Amplifier Sensitivity	$\Delta V/\Delta N$	42	$\mu V/e-$		
Peak Quantum Efficiency (KAI-43140-AXA and KAI-43140-QXA Configurations)	QE <sub>max</sub>	45	%		
Peak Quantum Efficiency (KAI-43140-FXA and KAI-43140-QXA Configurations)	Blue Green Red	QE <sub>max</sub>	37 34 27	%	

**Table 6. PERFORMANCE SPECIFICATIONS**

Description	Symbol	Min.	Nom.	Max.	Units	Temperature Tested At (°C)	Notes
Dark Field Global Non-Uniformity	DSNU	-	-	5	mVpp	27, 40	
Bright Field Global Non-Uniformity	BSNU	-	-	5	%rms	27, 40	3
Bright Field Global Peak to Peak Non-Uniformity	PRNU	-	-	30	%pp	27, 40	3
Maximum Gain Difference Between Outputs	$\Delta G$	-	-	10	%	27, 40	4
Horizontal CCD Charge Transfer Efficiency	HCTE	0.999995	0.999999	-			
Vertical CCD Charge Transfer Efficiency	VCTE	0.999995	0.999999	-			
Photodiode Dark Current	lpd	-	7	50	e/p/s	40	
Vertical CCD Dark Current	lvd	-	50	200	e/p/s	40	

3. Per color
4. Value is over the range of 10% to 90% of photodiode saturation.
5. The operating value of the substrate voltage, VAB, will be marked on the shipping container for each device. The value of VAB is set such that the photodiode charge capacity is 546 mV.
6. At 60 MHz
7. Uses 20 \* LOG (Pne/n<sub>e-T</sub>)
8. Assumed 5 pF load.
9. Green LED illumination



TYPICAL PERFORMANCE CURVES

Quantum Efficiency



Figure 6. Monochrome with Microlens Quantum Efficiency



Figure 7. Gen2 Color (Bayer RGB) with Microlens Quantum Efficiency



Figure 8. Color (Sparse CFA) with Microlens Quantum Efficiency

**Angular Quantum Efficiency**

For the curves marked “Horizontal”, the incident light angle is varied in a plane parallel to the HCCD.  
 For the curves marked “Vertical”, the incident light angle is varied in a plane parallel to the VCCD.



Figure 9. Monochrome with Microlens Angular Quantum Efficiency

# KAI-43140

## Dark Current versus Temperature



Figure 10. Dark Current versus Temperature

## Power



Figure 11. Power

Frame Rates



Figure 12. Frame Rates

DEFECT DEFINITIONS

Table 7. OPERATING CONDITIONS

Description	Condition	Notes
Light Source	Continuous Red, Green, and/or Blue LED Illumination	For the monochrome sensor, only the green LED is used
Operation	Nominal Operating Voltages and Timing	

Table 8. OPERATING PARAMETERS

Description	1 Output	4 Outputs
HCCD Clock Frequency	20 MHz	20 MHz
Pixels per Line	8160	4080
Lines per Frame	5480	5480
Line Time	429.6 $\mu$ s	225.6 $\mu$ s
Frame Time	2354.3 ms	618.2 ms

Table 9. TIMING MODES

Timing Mode	Conditions
Mode A	1 Output, no electronic shutter used. Photodiode integration time is equal to the Frame Time
Mode B	4 Outputs, no electronic shutter used. Photodiode integration time is equal to the Frame time

Table 10. DEFECT DEFINITIONS

Description	Definition	Grade 1	Grade 2 (mono)	Grade 2 (color)
Column Defect	A group of more than 10 contiguous pixels along a single column that deviate from the neighboring columns by: <ul style="list-style-type: none"> <li>more than 94 mV in the dark field using Timing Mode A at 40°C</li> <li>more than 94 mV in the dark field using Timing Mode A at 27°C</li> <li>more than -2% or +50% in the bright field using timing mode A at 27°C or 40°C</li> </ul>	0	7	27
Cluster Defect	A group of 2 to N contiguous defective pixels, but no more than W adjacent defects horizontally, that deviate from the neighboring pixels by: <ul style="list-style-type: none"> <li>more than 440 mV in the dark field using Timing Mode A at 40°C</li> <li>more than 236 mV in the dark field using Timing Mode A at 27°C</li> <li>more than -12% or +12% in the bright field using timing mode A at 27°C or 40°C</li> </ul>	30 W=4 N=19	70 W=5 N=38	70 W=5 N=38
Major Point Defect	A single defective pixel that deviates from the neighboring pixels by: <ul style="list-style-type: none"> <li>more than 440 mV in the dark field using Timing Mode A at 40°C</li> <li>more than 236 mV in the dark field using Timing Mode A at 27°C</li> <li>more than -12% or +50% in the bright field using timing mode A at 27°C or 40°C</li> </ul>	400	800	800
Minor Point Defect	A single defective pixel that deviates from the neighboring pixels by: <ul style="list-style-type: none"> <li>more than 220 mV in the dark field using Timing Mode A at 40°C</li> </ul>	4000	8000	8000

10. Bright field is define as where the average signal level of the sensor is 382 mV, with the substrate voltage set to the recommend VAB setting such that the capacity of the photodiodes is 546 mV (13,000 electrons)

11. For the color devices (KAI-43140-FXA or KAI-43140-QXA), a bright field defective pixel is with respect to pixels of the same color

12. Column and cluster defects are separated by no less than two (2) non-defective pixels in any direction (excluding single pixel defects).

**DEFECT MAP**

The defect map supplied with each sensor is based upon testing at an ambient (27°C) temperature. Minor point

defects are not included in the defect map. All defective pixels are reference to pixel 1, 1 in the defect maps.

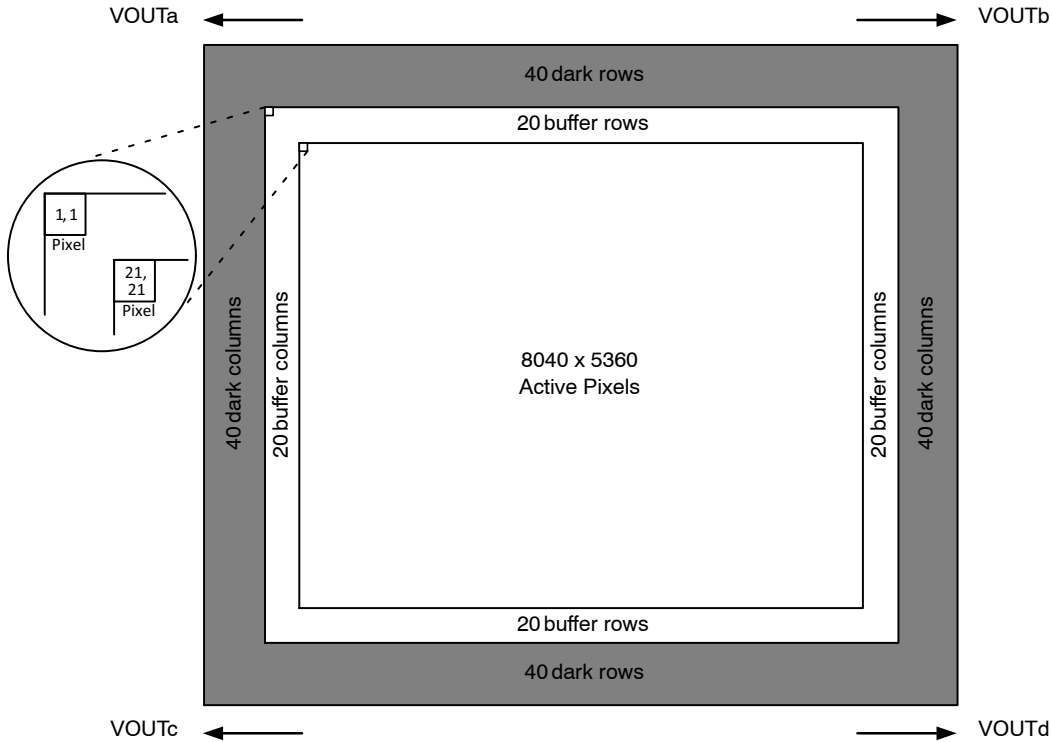

Figure 13. Pixel 1, 1 Location

OPERATION

Table 11. ABSOLUTE MAXIMUM RATINGS

Description	Symbol	Minimum	Maximum	Units	Notes
Operating Temperature	Top	-50	+70	°C	13, 15
Humidity	RH	5	90	%	14, 15
Output Bias Current	Iout	-	60	mA	16
Off-Chip Load	CL	-	10	pF	

Stresses exceeding those listed in the Maximum Ratings table may damage the device. If any of these limits are exceeded, device functionality should not be assumed, damage may occur and reliability may be affected.

13. Noise performance will degrade at higher temperatures.

14. T = 25 °C. Excessive humidity will degrade MTTF.

15. The KAI-43140 image sensors have epoxy sealed cover glass. The seal formed is non-hermetic, and may allow moisture ingress over time, depending on the storage environment. As a result, care must be taken to avoid cooling the device below the dew point inside the package cavity, since this may result in condensation on the sensor. For all KAI-43140 configurations, no warranty, expressed or implied, covers condensation.

16. Total for all outputs. Maximum current is -15 mA for each output. Avoid shorting output pins to ground or any low impedance source during operation. Amplifier bandwidth increases at higher current and lower load capacitance at the expense of reduced gain (sensitivity).

Table 12. ABSOLUTE MAXIMUM VOLTAGE RATINGS BETWEEN PINS AND GROUND

Description	Minimum	Maximum	Units	Notes
VDD $\alpha$ , VOUT $\alpha$	-0.4	+17.5	V	17
RD $\alpha$	-0.4	+15.5	V	17
V1TB	ESD - 0.4	ESD + 24.0	V	
V2B, V2T, V3B, V3T, V3B, V3T	ESD - 0.4	ESD + 14.0	V	
FDG $\alpha$ b, FDG $\alpha$ d	ESD - 0.4	ESD + 15.0	V	
H1 $\alpha$ , H2 $\alpha$ , H2L $\alpha$	ESD - 0.4	ESD + 14.0	V	17
R $\alpha$	ESD - 0.4	ESD + 18.0	V	17
ESD	-10	0.0	V	
SUB	-0.4	40.0	V	18

17.  $\alpha$  refers to a, b, c, or d.

18. Refer to Application Note Using Interline CCD Image Sensors in High Intensity Visible Lighting Conditions

**Power-Up and Power-Down Sequence**

Adherence to the power-up and power-down sequence is critical. Failure to follow the proper power-up and power-down sequences may cause damage to the sensor.

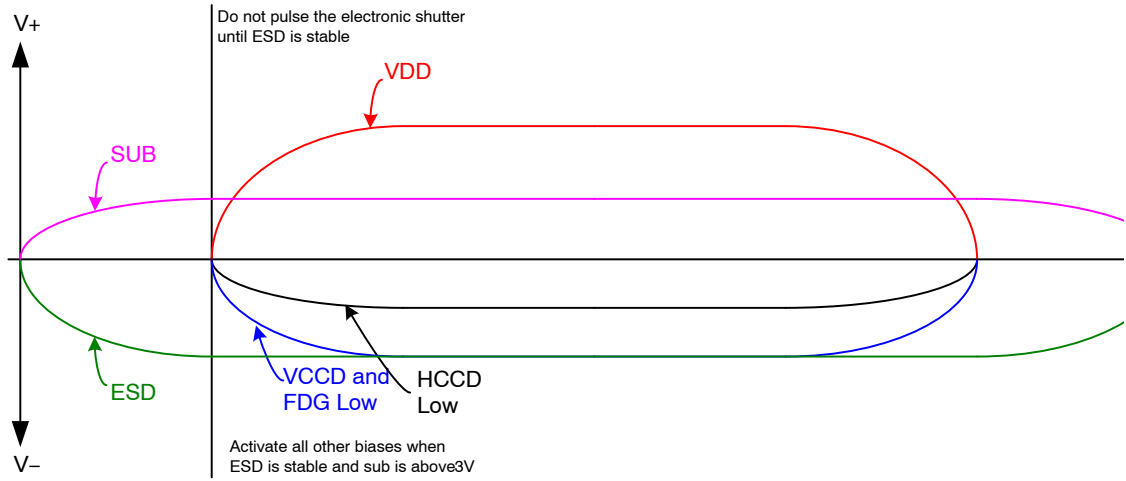

**NOTES:**

- 19. Activate all other biases when ESD is stable and SUB is above 3 V.
- 20. Do not pulse the electronic shutter until ESD is stable.
- 21. The VCCD clock waveform must not have a negative overshoot more than 0.4 V below the ESD voltage. See Figure 15.
- 22. The image sensor can be protected from an accidental improper ESD voltage by current limiting the SUB current to less than 10 mA. SUB and VDD must always be greater than GND. ESD must always be less than GND. Placing diodes between SUB, VDD, ESD and ground will protect the sensor from accidental overshoots of SUB, VDD and ESD during power on and power off. See Figure 16.

**Figure 14. Power-Up and Power-Down Sequence**



**Figure 15. VCCD Clock Overshoots**



**Figure 16. External Diode Protection**

Table 13. DC BIAS OPERATING CONDITIONS

Description	Pins	Symbol	Minimum	Nominal	Maximum	Units	Max. DC Current	Notes
Reset Drain	RD $\alpha$	RD	+12.3	+12.5	+12.7	V	10 $\mu$ A	23
Output Gate	OG $\alpha$	OG	+1.5	+1.7	+2.4	V	10 $\mu$ A	23
Output Amplifier Supply	VDD $\alpha$	VDD	+14.5	+15.0	+15.5	V	11.0 mA	23, 24
Ground	GND	GND	+0.0	+0.0	+0.0	V	-1.0 mA	
Substrate	SUB	VSUB	+5.0	VAB	VDD	V	50 $\mu$ A	25, 30
ESD Protection Disable	ESD	ESD	-9.2	-9.0	-8.8	V	50 $\mu$ A	28, 29
Output Bias Current	VOU $\alpha$	Iout	-3.0	-5.0	-10.0	mA		23, 26, 27

23.  $\alpha$  denotes a, b, c or d

24. The maximum DC current is for one output.  $I_{dd} = I_{out} + I_{ss}$ . See Figure 17.

25. The operating value of the substrate voltage, VAB, will be marked on the shipping container for each device. The value of VAB is set such that the photodiode charge capacity is the nominal PNe (see Specifications).

26. An output load sink must be applied to each VOUT pin to activate each output amplifier.

27. Nominal value required for 60 MHz operation per output. May be reduced for slower data rates and lower noise.

28. Adherence to the power-up and power-down sequence is critical. See Power-Up and Power-Down Sequence section.

29. ESD maximum value must be less than or equal to V1\_L - 0.4 V and V2\_L - 0.4 V.

30. Refer to Application Note *Using Interline CCD Image Sensors in High Intensity Visible Lighting Conditions*.



Figure 17. Output Amplifier



## AC OPERATING CONDITIONS

Table 14. CLOCK LEVELS

Description	Pins (Note 31)	Symbol	Level	Min	Nom	Max	Units	Capacitance (Note 32)
Vertical CCD Clock, Phase 1	V1B, V1T	V1_L	Low	-8.2	-8.0	-7.8	V	420 nF
		V1_M	Mid	-0.2	+0.0	+0.2		
		V1_H	High	+10.3	+10.5	+10.7		
Vertical CCD Clock, Phase 2	V2B, V2T	V2_L	Low	-8.2	-8.0	-7.8	V	240 nF
		V2_H	High	-0.2	+0.0	+0.2		
Vertical CCD Clock, Phase 3	V3B, V3T	V3_L	Low	-8.2	-8.0	-7.8	V	260 nF
		V3_H	High	-0.2	+0.0	+0.2		
Vertical CCD Clock, Phase 4	V4B, V4T	V4_L	Low	-8.2	-8.0	-7.8	V	240 nF
		V4_H	High	-0.2	+0.0	+0.2		
Horizontal CCD Clock, Phase 1 Storage	H1S $\alpha$	H1S_L	Low	-0.2	+0.0	+0.2	V	650 pF
		H1S_H	High	+3.8	+4.0	+5.2		
Horizontal CCD Clock, Phase 1 Barrier	H1B $\alpha$	H1B_L	Low	-0.2	+0.0	+0.2	V	680 pF
		H1B_H	High	+3.8	+4.0	+5.2		
Horizontal CCD Clock, Phase 2 Storage	H2S $\alpha$	H2S_L	Low	-0.2	+0.0	+0.2	V	560 pF
		H2S_H	High	+3.8	+4.0	+5.2		
Horizontal CCD Clock, Phase 2 Barrier	H2B $\alpha$	H2B_L	Low	-0.2	+0.0	+0.2	V	460 pF
		H2B_H	High	+3.8	+4.0	+5.2		
Horizontal CCD Clock, Last Phase (Note 33)	H2SL $\alpha$	H2SL_L	Low	-0.2	+0.0	+0.2	V	20 pF
		H2SL_H	High	+3.8	+4.0	+5.2		
Reset Gate	R $\alpha$	R_L (Note 34)	Low	+2.0	+3.0	+3.2	V	20 pF
		R_H	High	+6.8	+7.0	+7.2		
Electronic Shutter (Notes 35, 38)	SUB	VES	High	-	-	+40	V	12 nF
		VES_Offset	Offset	VAB + 24	VAB + 25	-		
Fast Line Dump Gate	FDG $\alpha$ b, FDG $\alpha$ d	FDG_L	Low	-8.2	-8.0	-7.8	V	200 pF
		FDG_H	High	+4.5	+5.0	+5.5		

31.  $\alpha$  denotes a, b, c or d.

32. Capacitance is total for all like named pins.

33. Use separate clock driver for improved speed performance.

34. Reset low should be set to +2.0 V for signal levels greater than 26,000 electrons.

35. Refer to Application Note *Using Interline CCD Image Sensors in High Intensity Visible Lighting Conditions*.

36. Capacitance values are estimated.

37. If the minimum horizontal clock low level is used (-0.2 V), then a 4 V clock amplitude should be used to create a -0.2 V to +3.8 V clock. For the maximum horizontal charge transfer efficiency performance a 5 volt clock amplitude may be used.

38. Figure 18 shows the DC bias (VSUB) and AC clock (VES) applied to the SUB pin. Both the DC bias and AC clock are referenced to ground. The VES\_Offset is referenced to VSUB.



Figure 18. VSUB and VES Reference

**Device Identification**

The device identification pin (DevID) may be used to determine which ON Semiconductor 5.5 micron pixel interline CCD sensor is being used.

**Table 15. DEVICE IDENTIFICATION**

Description	Pins	Symbol	Minimum	Nominal	Maximum	Unit	Max. DC Current	Notes
Device Identification	DevID	DevID	230,000	260,000	300,00	Ω	50 μA	39, 40, 41

39. Nominal value subject to verification and/or change during release of preliminary specifications.

40. If the Device Identification is not used, it may be left disconnected.

41. After Device Identification resistance has been read during camera initialization, it is recommended that the circuit be disabled to prevent localized heating of the sensor due to current flow through the R\_DeviceID resistor.

**Recommended Circuit**

Note that V1 must be a different value than V2.



**Figure 19. Device Identification Recommended Circuit**

## TIMING

Table 16. REQUIREMENTS AND CHARACTERISTICS

Description	Symbol	Minimum	Nominal	Maximum	Units	Notes
Photodiode Transfer	$T_{PD}$	6	–	–	$\mu\text{s}$	
VCCD Leading Pedestal	$T_{3P}$	16	–	–	$\mu\text{s}$	
VCCD Trailing Pedestal	$T_{3D}$	16	–	–	$\mu\text{s}$	
VCCD Transfer Delay	$T_D$	4	–	–	$\mu\text{s}$	
VCCD Transfer	$T_V$	10	–	–	$\mu\text{s}$	
VCCD Clock Cross-over	$V_{VCR}$	75	–	100	%	42
VCCD Rise, Fall Time	$T_{VR}, T_{VF}$	5	–	10	%	42, 43
FDG Delay	$T_{FDG}$	5	–	–	$\mu\text{s}$	
HCCD Delay	$T_{HS}$	1	–	–	$\mu\text{s}$	
HCCD Transfer	$T_E$	16.6667	–	–	ns	
Shutter Transfer	$T_{SUB}$	1	–	–	$\mu\text{s}$	
Shutter Delay	$T_{HD}$	1	–	–	$\mu\text{s}$	
Reset Pulse	$T_R$	2.5	–	–	ns	
Reset – Video Delay	$T_{RV}$	–	2.2	–	ns	
H2SL – Video Delay	$T_{HV}$	–	3.1	–	ns	
Line Time	$T_{LINE}$	89.21	–	–	$\mu\text{s}$	Dual/Quad HCCD Readout
		157.21	–	–		Single HCCD Readout
Frame Time	$T_{FRAME}$	244.43	–	–	ms	Quad HCCD Readout
		488.86	–	–		Dual HCCD Readout
		861.50	–	–		Single HCCD Readout

42. Refer to Figure 24: VCCD Clock Rise Time, Fall Time and Edge Alignment

43. Relative to the pulse width

# KAI-43140

## Timing Diagrams

The timing sequence for the clocked device pins may be represented as one of seven patterns (P1–P7) as shown in the

table below. The patterns are defined in Figure 20 and Figure 21. Contact ON Semiconductor Application Engineering for other readout modes.

**Table 17. TIMING SEQUENCE**

Device Pin	Quad Readout	Dual Readout VOUTa, VOUTb	Dual Readout VOUTa, VOUTc	Single Readout VOUTa
V1BT	P1BT	P1BT	P1BT	P1BT
V2T	P2T	P4B	P2T	P4B
V3T	P3T	P3B	P3T	P3B
V4T	P4T	P2B	P4T	P2B
V1BT	P1BT			
V2B	P2B			
V3B	P3B			
V4B	P4B			
H1Sa	P5			
H1Ba				
H2Sa (Note 45)	P6			
H2Ba				
Ra	P7			
H1Sb	P5		P5	
H1Bb			P6	
H2Sb (Note 45)	P6		P6	
H2Bb			P5	
Rb	P7		P7 <sup>44</sup> or Off <sup>46</sup>	P7 <sup>44</sup> or Off <sup>46</sup>
H1Sc	P5	P5 <sup>44</sup> or Off <sup>46</sup>	P5	P5 <sup>44</sup> or Off <sup>46</sup>
H1Bc				
H2Sc (Note 45)	P6	P6 <sup>44</sup> or Off <sup>46</sup>	P6	P6 <sup>44</sup> or Off <sup>46</sup>
H2Bc				
Rc	P7	P7 <sup>44</sup> or Off <sup>46</sup>	P7	P7 <sup>44</sup> or Off <sup>46</sup>
H1Sd	P5	P5 <sup>44</sup> or Off <sup>46</sup>	P5	P5 <sup>44</sup> or Off <sup>46</sup>
H1Bd			P6	
H2Sd (Note 45)	P6	P6 <sup>44</sup> or Off <sup>46</sup>	P6	P6 <sup>44</sup> or Off <sup>46</sup>
H2Bd			P5	
Rd	P7	P7 <sup>44</sup> or Off <sup>46</sup>	P7 <sup>44</sup> or Off <sup>46</sup>	P7 <sup>44</sup> or Off <sup>46</sup>
# Lines/Frame (Minimum)	2740	5480	2740	5480
# Pixels/Line (Minimum)	4092		8172	

44. For optimal performance of the sensor. May be clocked at a lower frequency. If clocked at a lower frequency, the frequency selected should be a multiple of the frequency used on the a and b register.

45. H2SLx follows the same pattern as H2Sx For optimal speed performance, use a separate clock driver.

46. Off = R\_H for the Reset Gate and H\_H for the Horizontal CCD gates. Note that there may be operating conditions (high temperature and/or very bright light sources) that will cause blooming from the unused c/d register into the image area.

**Photodiode Transfer Timing**

A row of charge is transferred to the HCCD on the falling edge of V1 as indicated in the P1 pattern below. Using this timing sequence, the leading dummy row or line is combined with the first dark row in the HCCD. The “Last Line” is dependent on readout mode – either 2740 or 5480 minimum counts required. It is important to note that, in

general, the rising edge of a vertical clock (patterns P1–P4) should be coincident or slightly leading a falling edge at the same time interval. This is particularly true at the point where P1 returns from the high (3<sup>rd</sup> level) state to the mid-state when P4 transitions from the low state to the high state.



**Figure 20. Photodiode Transfer Timing**

**Line and Pixel Timing**

Each row of charge is transferred to the output, as illustrated below, on the falling edge of H2SL (indicated as

P6 pattern). The number of pixels in a row is dependent on readout mode – either 4092 or 8172 minimum counts required.



**Figure 21. Line and Pixel Timing**

Pixel Timing Detail



Figure 22. Pixel Timing Detail

Frame/Electronic Shutter Timing

The SUB pin may be optionally clocked to provide electronic shuttering capability as shown below. The

resulting photodiode integration time is defined from the falling edge of SUB to the falling edge of V1 (P1 pattern).



Figure 23. Electronic Shutter Timing

VCCD Clock Edge Alignment



Figure 24. VCCD Clock Rise Time, Fall Time, and Edge Alignment

Line and Pixel Timing – Vertical Binning by 2



Figure 25. Line and Pixel Timing – Vertical Binning by 2

Fast Line Dump Timing

The FDG pins may be optionally clocked to efficiently remove unwanted lines in the image resulting for increased

frame rates at the expense of resolution. Below is an example of a 2 line dump sequence followed by a normal readout line.



Figure 26. Fast Line Dump Timing

## STORAGE AND HANDLING

Table 18. STORAGE CONDITIONS

Description	Symbol	Minimum	Maximum	Units	Notes
Storage Temperature	T <sub>AT</sub>	-55	+88	°C	47
Humidity	RH	5	90	%	48

47. Long term storage toward the maximum temperature will accelerate color filter degradation.

48. T = 25 °C. Excessive humidity will degrade MTF.

For information on ESD and cover glass care and cleanliness, please download the *Image Sensor Handling and Best Practices* Application Note (AN52561/D) from [www.onsemi.com](http://www.onsemi.com).

For information on soldering recommendations, please download the *Soldering and Mounting Techniques Reference Manual* (SOLDERRM/D) from [www.onsemi.com](http://www.onsemi.com).

For quality and reliability information, please download the *Quality & Reliability Handbook* (HBD851/D) from [www.onsemi.com](http://www.onsemi.com).

For information on device numbering and ordering codes, please download the *Device Nomenclature* technical note (TND310/D) from [www.onsemi.com](http://www.onsemi.com).

For information on Standard terms and Conditions of Sale, please download *Terms and Conditions* from [www.onsemi.com](http://www.onsemi.com).



MECHANICAL INFORMATION



NOTES:

- 49. Substrate = Schott D263T eco
- 50. Dust, Scratch, Inclusion Specification: 20 μm Max size in Zone A
- 51. MAR coated both sides
- 52. Spectral Transmission
  - 350–365 nm: T ≥ 88%
  - 365–405 nm: T ≥ 94%
  - 405–450 nm: T ≥ 98%
  - 450–650 nm: T ≥ 99%
  - 650–690 nm: T ≥ 98%
  - 690–770 nm: T ≥ 94%
  - 770–870 nm: T ≥ 88%
- 53. Units: IN [MM]

Figure 27. Cover Glass

# KAI-43140



**Figure 28. Cover Glass Transmission**

# MECHANICAL CASE OUTLINE PACKAGE DIMENSIONS

ON Semiconductor®



## CPGA72, 47.24x45.34 CASE 107ES ISSUE O

DATE 30 JUL 2014

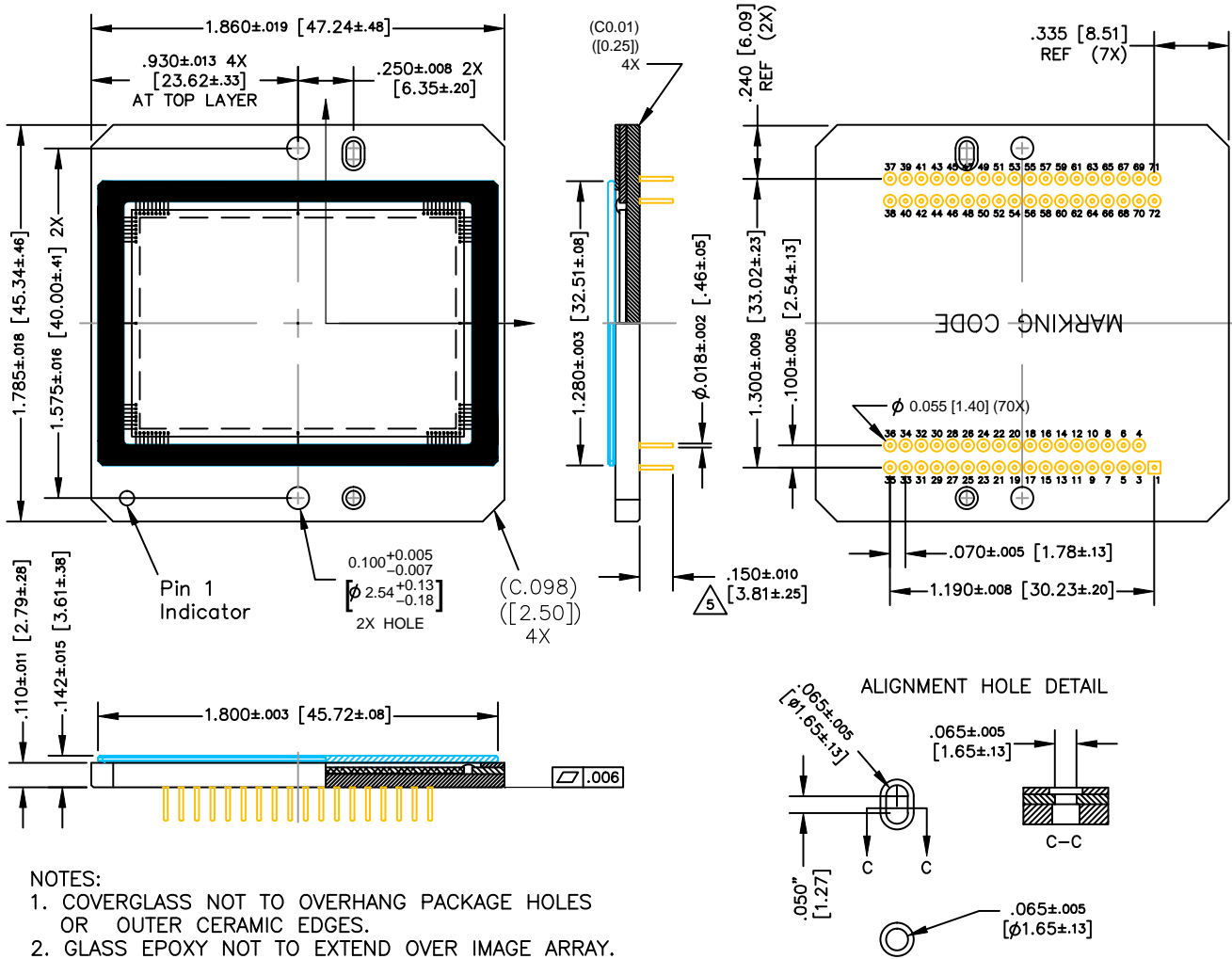

**NOTES:**

- COVERGLASS NOT TO OVERHANG PACKAGE HOLES OR OUTER CERAMIC EDGES.
- GLASS EPOXY NOT TO EXTEND OVER IMAGE ARRAY.
- NO MATERIALS TO INTERFERE WITH CLEARANCE THROUGH PACKAGE HOLES.
- ALL PIN DISTANCES MEASURED AT PIN BASE.

Dimensions in: Inches [mm]

<b>DOCUMENT NUMBER:</b>	98AON88267F	Electronic versions are uncontrolled except when accessed directly from the Document Repository. Printed versions are uncontrolled except when stamped "CONTROLLED COPY" in red.
<b>STATUS:</b>	ON SEMICONDUCTOR STANDARD	
<b>REFERENCE:</b>		
<b>DESCRIPTION:</b>	CPGA72, 47.24x45.34	<b>PAGE 1 OF 3</b>

**CPGA72, 47.24x45.34**  
CASE 107ES  
ISSUE O

DATE 30 JUL 2014

SHOWN WITHOUT COVER GLASS OR WIRES

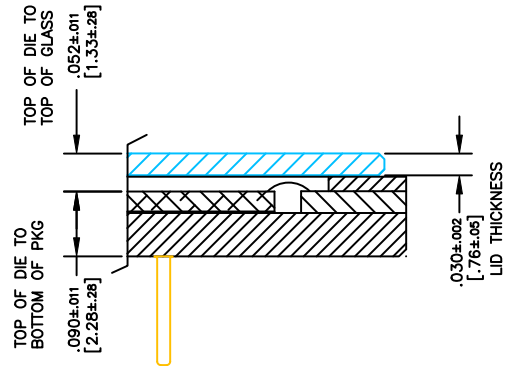

Dimensions in: Inches [mm]

<b>DOCUMENT NUMBER:</b>	<b>98AON88267F</b>	Electronic versions are uncontrolled except when accessed directly from the Document Repository. Printed versions are uncontrolled except when stamped "CONTROLLED COPY" in red.
<b>STATUS:</b>	<b>ON SEMICONDUCTOR STANDARD</b>	
<b>REFERENCE:</b>		
<b>DESCRIPTION:</b>	<b>CPGA72, 47.24x45.34</b>	<b>PAGE 2 OF 3</b>

ON Semiconductor®



DOCUMENT NUMBER:  
98AON88267F

PAGE 3 OF 3

ISSUE	REVISION	DATE
O	RELEASED FOR PRODUCTION FROM TRUESENSE MATERIAL NUMBER 20351897 TO ON SEMICONDUCTOR. REQ. BY D. TRUHITTE.	30 JUL 2014

ON Semiconductor and ON are registered trademarks of Semiconductor Components Industries, LLC (SCILLC). SCILLC reserves the right to make changes without further notice to any products herein. SCILLC makes no warranty, representation or guarantee regarding the suitability of its products for any particular purpose, nor does SCILLC assume any liability arising out of the application or use of any product or circuit, and specifically disclaims any and all liability, including without limitation special, consequential or incidental damages. "Typical" parameters which may be provided in SCILLC data sheets and/or specifications can and do vary in different applications and actual performance may vary over time. All operating parameters, including "Typicals" must be validated for each customer application by customer's technical experts. SCILLC does not convey any license under its patent rights nor the rights of others. SCILLC products are not designed, intended, or authorized for use as components in systems intended for surgical implant into the body, or other applications intended to support or sustain life, or for any other application in which the failure of the SCILLC product could create a situation where personal injury or death may occur. Should Buyer purchase or use SCILLC products for any such unintended or unauthorized application, Buyer shall indemnify and hold SCILLC and its officers, employees, subsidiaries, affiliates, and distributors harmless against all claims, costs, damages, and expenses, and reasonable attorney fees arising out of, directly or indirectly, any claim of personal injury or death associated with such unintended or unauthorized use, even if such claim alleges that SCILLC was negligent regarding the design or manufacture of the part. SCILLC is an Equal Opportunity/Affirmative Action Employer. This literature is subject to all applicable copyright laws and is not for resale in any manner.

ON Semiconductor and  are trademarks of Semiconductor Components Industries, LLC dba ON Semiconductor or its subsidiaries in the United States and/or other countries. ON Semiconductor owns the rights to a number of patents, trademarks, copyrights, trade secrets, and other intellectual property. A listing of ON Semiconductor's product/patent coverage may be accessed at [www.onsemi.com/site/pdf/Patent-Marking.pdf](http://www.onsemi.com/site/pdf/Patent-Marking.pdf). ON Semiconductor reserves the right to make changes without further notice to any products herein. ON Semiconductor makes no warranty, representation or guarantee regarding the suitability of its products for any particular purpose, nor does ON Semiconductor assume any liability arising out of the application or use of any product or circuit, and specifically disclaims any and all liability, including without limitation special, consequential or incidental damages. Buyer is responsible for its products and applications using ON Semiconductor products, including compliance with all laws, regulations and safety requirements or standards, regardless of any support or applications information provided by ON Semiconductor. "Typical" parameters which may be provided in ON Semiconductor data sheets and/or specifications can and do vary in different applications and actual performance may vary over time. All operating parameters, including "Typicals" must be validated for each customer application by customer's technical experts. ON Semiconductor does not convey any license under its patent rights nor the rights of others. ON Semiconductor products are not designed, intended, or authorized for use as a critical component in life support systems or any FDA Class 3 medical devices or medical devices with a same or similar classification in a foreign jurisdiction or any devices intended for implantation in the human body. Should Buyer purchase or use ON Semiconductor products for any such unintended or unauthorized application, Buyer shall indemnify and hold ON Semiconductor and its officers, employees, subsidiaries, affiliates, and distributors harmless against all claims, costs, damages, and expenses, and reasonable attorney fees arising out of, directly or indirectly, any claim of personal injury or death associated with such unintended or unauthorized use, even if such claim alleges that ON Semiconductor was negligent regarding the design or manufacture of the part. ON Semiconductor is an Equal Opportunity/Affirmative Action Employer. This literature is subject to all applicable copyright laws and is not for resale in any manner.

## PUBLICATION ORDERING INFORMATION

### LITERATURE FULFILLMENT:

Literature Distribution Center for ON Semiconductor  
19521 E. 32nd Pkwy, Aurora, Colorado 80011 USA  
**Phone:** 303-675-2175 or 800-344-3860 Toll Free USA/Canada  
**Fax:** 303-675-2176 or 800-344-3867 Toll Free USA/Canada  
**Email:** [orderlit@onsemi.com](mailto:orderlit@onsemi.com)

**N. American Technical Support:** 800-282-9855 Toll Free  
USA/Canada  
**Europe, Middle East and Africa Technical Support:**  
Phone: 421 33 790 2910

**ON Semiconductor Website:** [www.onsemi.com](http://www.onsemi.com)

**Order Literature:** <http://www.onsemi.com/orderlit>

For additional information, please contact your local  
Sales Representative

## Данный компонент на территории Российской Федерации

### Вы можете приобрести в компании MosChip.

Для оперативного оформления запроса Вам необходимо перейти по данной ссылке:

<http://moschip.ru/get-element>

Вы можете разместить у нас заказ для любого Вашего проекта, будь то серийное производство или разработка единичного прибора.

В нашем ассортименте представлены ведущие мировые производители активных и пассивных электронных компонентов.

Нашей специализацией является поставка электронной компонентной базы двойного назначения, продукции таких производителей как XILINX, Intel (ex.ALTERA), Vicor, Microchip, Texas Instruments, Analog Devices, Mini-Circuits, Amphenol, Glenair.

Сотрудничество с глобальными дистрибьюторами электронных компонентов, предоставляет возможность заказывать и получать с международных складов практически любой перечень компонентов в оптимальные для Вас сроки.

На всех этапах разработки и производства наши партнеры могут получить квалифицированную поддержку опытных инженеров.

Система менеджмента качества компании отвечает требованиям в соответствии с ГОСТ Р ИСО 9001, ГОСТ РВ 0015-002 и ЭС РД 009

### Офис по работе с юридическими лицами:

105318, г.Москва, ул.Щербаковская д.3, офис 1107, 1118, ДЦ «Щербаковский»

Телефон: +7 495 668-12-70 (многоканальный)

Факс: +7 495 668-12-70 (доб.304)

E-mail: [info@moschip.ru](mailto:info@moschip.ru)

Skype отдела продаж:

moschip.ru

moschip.ru\_4

moschip.ru\_6

moschip.ru\_9