

DATA SHEET

ARRAY CHIP RESISTORS

YC/TC

5%, 1%

sizes

YC: 102/104/122/124/162/164/248/324/158T/358L/358T

TC: 122/124/164

RoHS compliant



PHYCOMP BRAND ordering codes

Both GLOBAL PART NUMBER (preferred) and I2NC (traditional) codes are acceptable to order Phycomp brand products.

GLOBAL PART NUMBER (PREFERRED)

For detailed information of GLOBAL PART NUMBER and ordering example, please refer to page 2. TC122 series is supplied and ordered by global part number only.

I2NC CODE

TYPE/ 2×0402	2350	XXX XXXXX L				PAPER / PE TAPE ON REEL (units) ⁽²⁾	
	(1)	(2)	(3)	(4)	10,000	50,000	
ARV321	2350	±5%	1 to 1 MΩ		013 11xxx	013 12xxx	
ARV322	2350	±1%	10 to 1 MΩ		013 2xxxx	013 3xxxx	
Jumper	2350	-	0 Ω		013 91001	-	

Last digit of I2NC Resistance decade ⁽³⁾	Last digit
0.01 to 0.0976 Ω	0
0.1 to 0.976 Ω	7
1 to 9.76 Ω	8
10 to 97.6 Ω	9
100 to 976 Ω	1
1 to 9.76 KΩ	2
10 to 97.6 KΩ	3
100 to 976 KΩ	4
1 to 9.76 MΩ	5
10 to 97.6 MΩ	6

- (1) The resistors have a 12-digit ordering code starting with 2350.
- (2) The subsequent 4 or 5 digits indicate the resistor tolerance and packaging.
- (3) The remaining 4 or 3 digits represent the resistance value with the last digit indicating the multiplier as shown in the table of "Last digit of I2NC".
- (4) "L" is optional symbol ^(Note).

Example:

0.02 Ω	=	0200 or 200
0.3 Ω	=	3007 or 307
1 Ω	=	1008 or 108
33 KΩ	=	3303 or 333
10 MΩ	=	1006 or 106

ORDERING EXAMPLE

The ordering code of a ARV321 resistor, value 1,000Ω with ±5% tolerance, supplied in tape of 10,000 units per reel is: 235001311102(L) or YC122-JR-071KL.

NOTE

1. All our RSMD products are RoHS compliant. "LFP" of the internal 2D reel label mentions "Lead Free Process"
2. On customized label, "LFP" or specific symbol printed and the optional "L" at the end of GLOBAL PART NUMBER / I2NC can be added (both are on customer request)

MARKING

YCI02

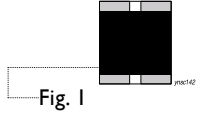

No marking

YCI22

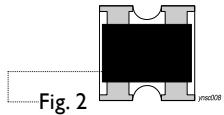

No marking

YCI04

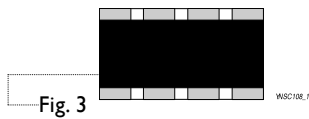

No marking

YCI24 / 162 / 164 / 324

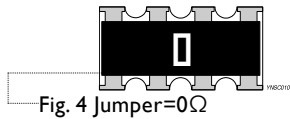

I-Digit marking

Fig. 4 Jumper=0Ω

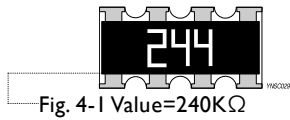

E-24 series: 3 digits, 5%
First two digits for significant figure and 3rd digit for number of zeros

Fig. 4-1 Value=240KΩ

YC248

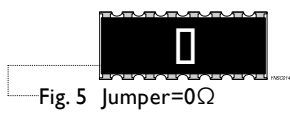

I-Digit marking

Fig. 5 Jumper=0Ω

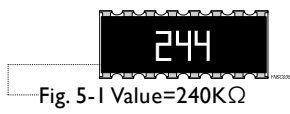

E-24 series: 3 digits, 5%
First two digits for significant figure and 3rd digit for number of zeros

Fig. 5-1 Value=240KΩ

YCI58T/358L/358T

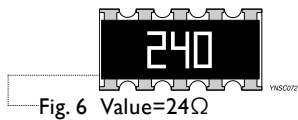

Fig. 6 Value=24Ω

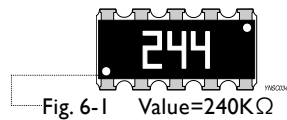
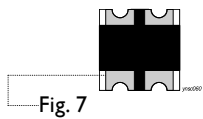

Fig. 6-1 Value=240KΩ

E-24 series: 3 digits
First two digits for significant figure and 3rd digit for number of zeros

TCI22



No marking

Fig. 7

TCI24

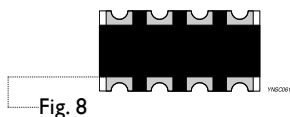

No marking

Fig. 8

TCI64



I-Digit marking

Fig. 9 Jumper=0Ω



E-24 series: 3 digits, 5%

First two digits for significant figure and 3rd digit for number of zeros

Fig. 9-1 Value=240KΩ

For further marking information, please refer to data sheet “Chip resistors marking”.

CONSTRUCTION

The resistor is constructed on top of a high-grade ceramic body. Internal metal electrodes are added on each end to make the contacts to the thick film resistive element. The composition of the resistive element is a noble metal imbedded into a glass and covered by a second glass to prevent environment influences. The resistor is laser trimmed to the rated resistance value. The resistor is covered with a protective epoxy coat, finally the two external terminations (matte tin on Ni-barrier) are added as shown in Fig.9.

OUTLINES

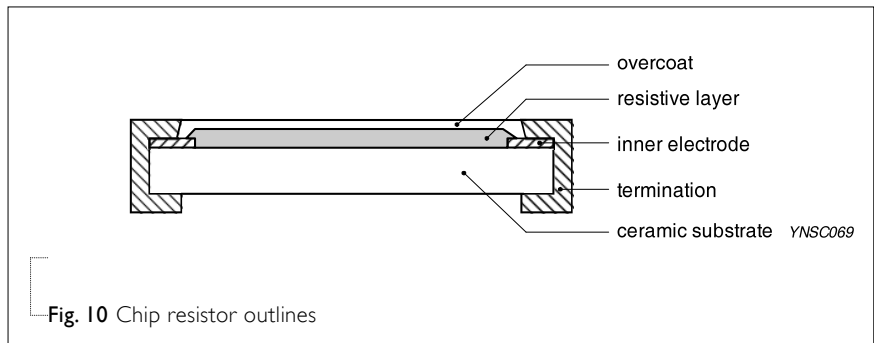

SCHEMATIC



DIMENSIONS

Table I

TYPE	H / H _I / H _W	B	P	L	T	W1	W2
YCI02	H: 0.25 ± 0.10	0.15 ± 0.10	0.55 ± 0.10	0.80 ± 0.10	0.35 ± 0.10	0.15 ± 0.10	0.60 ± 0.10
YCI04	H: 0.20 ± 0.10	0.15 ± 0.05	0.40 ± 0.10	1.40 ± 0.10	0.35 ± 0.10	0.15 ± 0.10	0.60 ± 0.10
YCI22	H: 0.21+0.10 / -0.05 H _W : 0.35 ± 0.10	0.20 ± 0.10	0.67 ± 0.05	1.00 ± 0.10	0.30 ± 0.10	0.25 ± 0.10	1.00 ± 0.10
YCI24	H: 0.45 ± 0.05 H _I : 0.30 ± 0.05	0.20 ± 0.15	0.50 ± 0.05	2.00 ± 0.10	0.45 ± 0.10	0.30 ± 0.15	1.00 ± 0.10
YCI62	H: 0.30 ± 0.10 H _W : 0.65 ± 0.15	0.30 ± 0.10	0.80 ± 0.05	1.60 ± 0.10	0.40 ± 0.10	0.30 ± 0.10	1.60 ± 0.10
YCI64	H: 0.65 ± 0.05 H _I : 0.50 ± 0.15	0.30 ± 0.15	0.80 ± 0.05	3.20 ± 0.15	0.60 ± 0.10	0.30 ± 0.15	1.60 ± 0.15
YC248	H: 0.45 ± 0.05 H _I : 0.30 ± 0.05	0.30 ± 0.15	0.50 ± 0.05	4.00 ± 0.20	0.45 ± 0.10	0.40 ± 0.15	1.60 ± 0.15
YC324	H: 1.10 ± 0.15 H _I : 0.90 ± 0.15	0.50 ± 0.20	1.27 ± 0.05	5.08 ± 0.20	0.60 ± 0.10	0.50 ± 0.15	3.20 ± 0.20
TCI22	H: 0.30 ± 0.05	0.25 ± 0.15	0.50 ± 0.05	1.00 ± 0.10	0.30 ± 0.10	0.25 ± 0.15	1.00 ± 0.10
TCI24	H: 0.30 ± 0.10	0.20 ± 0.10	0.50 ± 0.05	2.00 ± 0.10	0.40 ± 0.10	0.25 ± 0.10	1.00 ± 0.10
TCI64	H: 0.50 ± 0.15	0.30 ± 0.15	0.80 ± 0.05	3.20 ± 0.15	0.60 ± 0.10	0.30 ± 0.15	1.60 ± 0.15
YCI58T	H: 0.45 ± 0.05 H _I : 0.32 ± 0.05	0.30 ± 0.15	0.64 ± 0.05	3.20 ± 0.20	0.60 ± 0.10	0.35 ± 0.15	1.60 ± 0.15
YC358L	H: 1.10 ± 0.15	0.50 ± 0.15	1.27 ± 0.05	6.40 ± 0.20	0.60 ± 0.10	0.50 ± 0.15	3.20 ± 0.20
YC358T	H _I : 0.90 ± 0.15						

ELECTRICAL CHARACTERISTICS

Table 2

TYPE	POWER P ₇₀	OPERATING TEMP. RANGE	MWV	RCOV	DWV	RESISTANCE RANGE & TOLERANCE	T. C. R.	Jumper criteria (unit: A)
YC102	1/32W	-55°C to +125°C	15V	30V	30V	E24 ±5% 10Ω ≤ R ≤ 1MΩ E24/E96 ±1% 10Ω ≤ R ≤ 1MΩ Jumper < 0.05Ω	±200 ppm/°C	Rated current 0.5 Max. current 1.0
YC104	1/32W	-55°C to +125°C	12.5V	25V	25V	E24 ±5% 10Ω ≤ R ≤ 1MΩ E24/E96 ±1% 10Ω ≤ R ≤ 1MΩ Jumper < 0.05Ω		Rated current 0.5 Max. current 1.0
YC122	1/16W	-55°C to +155°C	50V	100V	100V	E24 ±5% 1Ω ≤ R ≤ 1MΩ E24/E96 ±1% 1Ω ≤ R ≤ 1MΩ Jumper < 0.05Ω	1Ω ≤ R ≤ 10Ω ±250 ppm/°C 10Ω ≤ R ≤ 1MΩ ±200 ppm/°C	Rated current 0.5 Max. current 1.0
YC124	1/16W	-55°C to +155°C	25V	50V	100V	E24 ±5% 1Ω ≤ R ≤ 1MΩ E24/E96 ±1% 1Ω ≤ R ≤ 1MΩ Jumper < 0.05Ω		Rated current 1.0 Max. current 2.0
YC162	1/16W	-55°C to +155°C	50V	100V	100V	E24 ±5% 1Ω ≤ R ≤ 1MΩ E24/E96 ±1% 1Ω ≤ R ≤ 1MΩ Jumper < 0.05Ω		Rated current 1.0 Max. current 2.0
YC164	1/16W	-55°C to +155°C	50V	100V	100V	E24 ±5% 1Ω ≤ R ≤ 1MΩ E24/E96 ±1% 1Ω ≤ R ≤ 1MΩ Jumper < 0.05Ω		Rated current 1.0 Max. current 2.0
YC248	1/16W	-55°C to +155°C	50V	100V	100V	E24 ±5% 10Ω ≤ R ≤ 1MΩ E24/E96 ±1% 10Ω ≤ R ≤ 1MΩ Jumper < 0.05Ω		Rated current 2.0 Max. current 10.0
YC324	1/8W	-55°C to +155°C	200V	500V	500V	E24 ±5% 10Ω ≤ R ≤ 1MΩ E24/E96 ±1% 10Ω ≤ R ≤ 1MΩ		---
TC122	1/16W	-55°C to +125°C	50V	100V	100V	E24 ±5% 10Ω ≤ R ≤ 1MΩ E24/E96 ±1% 10Ω ≤ R ≤ 1MΩ Jumper < 0.05Ω	±200 ppm/°C	Rated current 1.0 Max. current 1.5
TC124	1/16W	-55°C to +125°C	50V	100V	100V	E24 ±5% 10Ω ≤ R ≤ 1MΩ E24/E96 ±1% 10Ω ≤ R ≤ 1MΩ Jumper < 0.05Ω		Rated current 1.0 Max. current 1.5
TC164	1/16W	-55°C to +155°C	50V	100V	100V	E24 ±5% 10Ω ≤ R ≤ 1MΩ E24/E96 ±1% 10Ω ≤ R ≤ 1MΩ Jumper < 0.05Ω		Rated current 1.0 Max. current 2.0
YC158T	1/16W	-55°C to +155°C	25V	50V	50V	E24 ±5% 10Ω ≤ R ≤ 100KΩ		---
YC358L YC358T	1/16W	-55°C to +155°C	50V	100V	100V	E24 ±5% 10Ω ≤ R ≤ 330KΩ		---

FOOTPRINT AND SOLDERING PROFILES

For recommended footprint and soldering profiles, please refer to data sheet “Chip resistors mounting”.

PACKING STYLE AND PACKAGING QUANTITY

Table 3 Packing style and packaging quantity

PACKING STYLE	PACKING STYLE	YC102/ 104	YC/TC 122	YC/TC 124	YC162	YC/TC 164	YC248	YC324	YC158T	YC358L YC358T
Paper taping reel (R)	7" (178mm)	10,000	10,000	10,000	5,000	5,000	5,000	---	5,000	---
	13" (254mm)	50,000	50,000	40,000	---	20,000	---	---	20,000	---
Embossed taping reel (K)	7" (178mm)	---	---	---	---	---	4,000	4,000	---	4,000

NOTE

I. For tape and reel specification/dimensions, please refer to data sheet “Chip resistors packing”.

FUNCTIONAL DESCRIPTION

OPERATING TEMPERATURE RANGE

YC102/104/122/162, TC122/124 Range:

-55°C to +125°C (Fig.13)

YC124/164/248/324/158T/358L/358T, TC164 Range:

-55°C to +155°C(Fig.14)

POWER RATING

Each type rated power at 70°C

YC102/104 = 1/32 W

YC122/124/162/164/248/158T/358L/358T = 1/16 W

YC324 = 1/8 W

TC122/124/164 = 1/16 W

RATED VOLTAGE

The DC or AC (rms) continuous working voltage corresponding to the rated power is determined by the following formula:

$$V = \sqrt{(P \times R)}$$

or max. working voltage whichever is less

Where

V=Continuous rated DC or AC (rms) working voltage (V)

P=Rated power (W)

R=Resistance value (Ω)

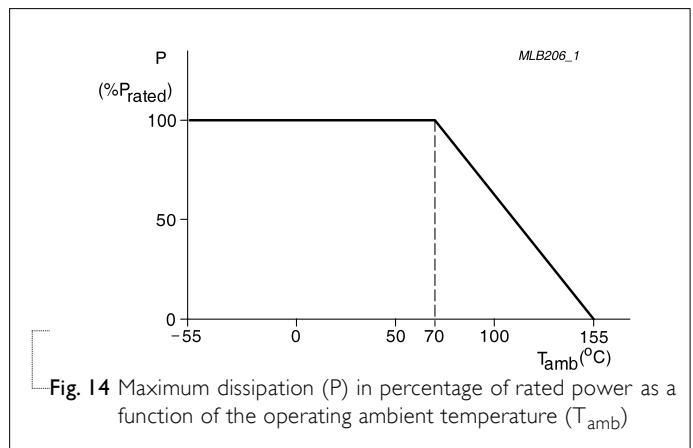

TESTS AND REQUIREMENTS
Table 4 Test condition, procedure and requirements

TEST	TEST METHOD	PROCEDURE	REQUIREMENTS
Life/ Operational Life/ Endurance	MIL-STD-202G-method 108A	1,000 hours at 70±5 °C applied RCWV	±(2%+0.05 Ω)
	IEC 60115-1 4.25.1	1.5 hours on, 0.5 hour off, still air required	<100 mΩ for Jumper
	JIS C 5202-7.10		
High Temperature Exposure/ Endurance at Upper Category Temperature	MIL-STD-202G-method 108A	1,000 hours at maximum operating	±(1%+0.05 Ω)
	IEC 60115-1 4.25.3	temperature depending on specification, unpowered	<50 mΩ for Jumper
	JIS C 5202-7.11	No direct impingement of forced air to the parts Tolerances: 125±3 °C	
Moisture Resistance	MIL-STD-202G-method 106F	Each temperature / humidity cycle is defined at	±(2%+0.05 Ω)
	IEC 60115-1 4.24.2	8 hours (method 106F), 3 cycles / 24 hours for 10d with 25 °C / 65 °C 95% R.H, without steps 7a & 7b, unpowered	<100 mΩ for Jumper
		Parts mounted on test-boards, without condensation on parts Measurement at 24±2 hours after test conclusion	
Thermal Shock	MIL-STD-202G-method 107G	-55/+125 °C	±(1%+0.05 Ω)
		Note: Number of cycles required is 300. Devices mounted	<50 mΩ for Jumper
		Maximum transfer time is 20 seconds. Dwell time is 15 minutes. Air – Air	
Short Time Overload	MIL-R-55342D-para 4.7.5	2.5 times RCWV or maximum overload	±(2%+0.05 Ω)
	IEC60115-1 4.13	voltage whichever is less for 5 sec at room temperature	<50 mΩ for Jumper No visible damage
Board Flex/ Bending	IEC60115-1 4.33	Device mounted on PCB test board as described, only 1 board bending required	±(1%+0.05 Ω)
		3 mm bending	<50 mΩ for Jumper
		Bending time: 60±5 seconds Ohmic value checked during bending	No visible damage

TEST	TEST METHOD	PROCEDURE	REQUIREMENTS
Solderability - Wetting	IPC/JEDECJ-STD-002B test B IEC 60068-2-58	Electrical Test not required Magnification 50X SMD conditions: 1 st step: method B, aging 4 hours at 155 °C dry heat 2 nd step: leadfree solder bath at 245±3 °C Dipping time: 3±0.5 seconds	Well tinned (≥95% covered) No visible damage
- Leaching	IPC/JEDECJ-STD-002B test D IEC 60068-2-58	Leadfree solder, 260 °C, 30 seconds immersion time	No visible damage
- Resistance to Soldering Heat	MIL-STD-202G-method 210F IEC 60068-2-58	Condition B, no pre-heat of samples Leadfree solder, 260 °C, 10 seconds immersion time Procedure 2 for SMD: devices fluxed and cleaned with isopropanol	±(1%+0.05 Ω) <50 mΩ for Jumper No visible damage

REVISION HISTORY

REVISION	DATE	CHANGE NOTIFICATION	DESCRIPTION
Version 7	Aug. 22, 2017	-	- Correct the typo for YC158T/358L/358T, Marking, "240" is 24ohm
Version 6	Jun. 1, 2017	-	- Update ordering information for networks YC158T/YC358L/YC358T
Version 5	Feb. 14, 2017	-	- Update YC158 and 358 part number to YC158T, YC358L and YC358T
Version 4	Dec. 22, 2016	-	- Delete YC102 default code L type
Version 3	Apr. 29, 2016	-	- Update YC series and TCI64 dimension
Version 2	Dec. 11, 2015	-	- Update Operating Temperature
Version 1	Feb. 04, 2015	-	- Update YC102 to flat type
Version 0	Nov. 14, 2014	-	- First issue of this specification

“Yageo reserves all the rights for revising the content of this datasheet without further notification, as long as the products itself are unchanged. Any product change will be announced by PCN.”

Mouser Electronics

Authorized Distributor

Click to View Pricing, Inventory, Delivery & Lifecycle Information:

Yageo:

[TC164-FR-0733R2L](#) [TC164-FR-0724RL](#) [TC164-FR-0727RL](#) [TC164-FR-0751RL](#) [TC164-FR-072K21L](#) [TC164-FR-078K25L](#) [TC164-FR-0715KL](#) [TC164-FR-071ML](#) [TC164-FR-0724R9L](#) [TC164-FR-07499RL](#) [TC164-FR-072K7L](#) [TC164-FR-072KL](#) [TC164-FR-077K5L](#) [TC124-JR-077R5L](#) [TC124-JR-073RL](#) [TC164-FR-0756RL](#) [TC164-FR-0751R1L](#) [TC164-FR-072K4L](#) [TC164-FR-07330KL](#) [TC164-FR-07402RL](#) [TC124-FR-074K7L](#) [TC124-FR-0739RL](#) [TC164-FR-0718RL](#) [TC164-FR-0713KL](#) [TC164-FR-077K68L](#) [TC124-FR-0747RL](#) [TC164-FR-073K32L](#) [TC164-FR-071K82L](#) [TC164-FR-071K3L](#) [TC164-FR-0746R4L](#) [TC164-FR-0762KL](#) [TC164-FR-0711KL](#) [TC164-FR-07560KL](#) [TC124-JR-075R1L](#) [TC164-FR-07430KL](#) [TC124-FR-07100KL](#) [TC164-FR-07200KL](#) [TC164-FR-07510RL](#) [TC124-FR-0722RL](#) [TC124-FR-0733RL](#) [TC164-JR-075R1L](#) [TC164-FR-0727R4L](#) [TC164-FR-07680KL](#) [TC124-FR-07330RL](#) [TC124-FR-075K1L](#) [TC164-JR-073RL](#) [TC164-FR-0736KL](#) [TC124-FR-071KL](#) [TC124-FR-0756RL](#) [TC124-FR-072K4L](#) [TC164-FR-078K2L](#) [TC164-FR-0782KL](#) [TC164-FR-071K62L](#) [TC124-FR-0760R4L](#) [TC124-FR-0724R9L](#) [TC164-FR-0724KL](#) [TC164-FR-0756KL](#) [TC122-JR-073RL](#) [TC164-FR-07110RL](#) [TC164-FR-0718KL](#) [TC164-FR-0775RL](#) [TC164-FR-07390KL](#) [TC164-FR-0756R2L](#) [TC164-FR-0730R1L](#) [TC164-FR-076K8L](#) [TC164-FR-07332RL](#) [TC164-FR-076K2L](#) [TC164-FR-073KL](#) [TC164-FR-0775KL](#) [TC164-FR-07120KL](#) [TC164-FR-0751K1L](#) [TC164-FR-079K1L](#) [TC164-FR-075K1L](#) [TC164-FR-07180RL](#) [TC164-FR-0739KL](#) [TC164-FR-0791KL](#) [TC164-FR-071K2L](#) [TC164-FR-07750RL](#) [TC164-FR-07150KL](#) [TC164-FR-0751KL](#) [TC164-FR-0784R5L](#) [TC164-FR-07200RL](#) [TC124-FR-0762RL](#) [TC164-FR-073K6L](#) [TC124-FR-0727R4L](#) [TC164-FR-0739RL](#) [TC124-FR-0751RL](#) [TC124-FR-0733KL](#) [TC124-FR-0710KL](#) [TC124-FR-0749R9L](#) [TC164-FR-07160KL](#) [TC124-FR-07619RL](#) [TC164-FR-1320KL](#) [TC164-JR-1322KL](#) [TC164-JR-1327KL](#) [TC164-FR-1347KL](#) [TC164-JR-10100KL](#) [TC124-JR-0782RL](#) [TC164-FR-1368KL](#) [TC164-JR-132K2L](#)

Данный компонент на территории Российской Федерации

Вы можете приобрести в компании MosChip.

Для оперативного оформления запроса Вам необходимо перейти по данной ссылке:

<http://moschip.ru/get-element>

Вы можете разместить у нас заказ для любого Вашего проекта, будь то серийное производство или разработка единичного прибора.

В нашем ассортименте представлены ведущие мировые производители активных и пассивных электронных компонентов.

Нашей специализацией является поставка электронной компонентной базы двойного назначения, продукции таких производителей как XILINX, Intel (ex.ALTERA), Vicor, Microchip, Texas Instruments, Analog Devices, Mini-Circuits, Amphenol, Glenair.

Сотрудничество с глобальными дистрибьюторами электронных компонентов, предоставляет возможность заказывать и получать с международных складов практически любой перечень компонентов в оптимальные для Вас сроки.

На всех этапах разработки и производства наши партнеры могут получить квалифицированную поддержку опытных инженеров.

Система менеджмента качества компании отвечает требованиям в соответствии с ГОСТ Р ИСО 9001, ГОСТ РВ 0015-002 и ЭС РД 009

Офис по работе с юридическими лицами:

105318, г.Москва, ул.Щербаковская д.3, офис 1107, 1118, ДЦ «Щербаковский»

Телефон: +7 495 668-12-70 (многоканальный)

Факс: +7 495 668-12-70 (доб.304)

E-mail: info@moschip.ru

Skype отдела продаж:

moschip.ru

moschip.ru_4

moschip.ru_6

moschip.ru_9