

## Specification

Part No.	:	<b>WCM.01.0111</b>
Product Name:	:	2.4GHz Button Antenna
Features	:	Tiny Size – 19.8mm*14.3mm*16.4mm 2400MHz to 2500MHz Antenna Wi-Fi / Bluetooth >60% Efficiency Connector: SMA(M) IP67 Waterproof Housing Omni directional ROHS Compliant



## 1. Introduction

The WCM.01 2.4GHz antenna is the smallest SMA(M) connector mount external antenna in the market, fitting into spaces no other traditional monopole, dipole or rubber ducky antenna can go. Its unique PIFA design provides omni-directional gain across the 2.4GHz to 2.5GHz range, ensuring constant reception and transmission for 2.4GHz Wi-Fi and Bluetooth applications.

This antenna features greater than 60% efficiency when connected directly to the ground plane of the device.

Typical Applications Include:

- Application Points
- Routers
- IoT M2M Devices
- Smart Home Applications

The WCM.01 antenna has an IP67 water proof enclosure and comes with an SMA(M) connector, making it compatible with most Wi-Fi applications and routers on the market. An RP-SMA(M) version is also available, WCM.01.0151. For ideal radiation, mount the WCM.01 clear of metal.

Many module manufacturers specify peak gain limits for any antennas that are to be connected to that module. Those peak gain limits are based on freespace conditions. In practice, the peak gain of an antenna tested in freespace can degrade by at least 1 or 2 dBi when put inside a device. So ideally you should go for a slightly higher peak gain antenna than mentioned on the module specification to compensate for this effect, giving you better performance.

Upon testing of any of our antennas with your device and a selection of appropriate layout, integration technique, or cable, Taoglas can make sure any of our antennas' peak gain will be below the peak gain limits.

Taoglas can then issue a specification and/or report for the selected antenna in your device that will clearly show it complying with the peak gain limits, so you can be assured you are meeting regulatory requirements for that module.

For example, a module manufacturer may state that the antenna must have less than 2 dBi peak gain, but you don't need to select an embedded antenna that has a peak gain of less than 2 dBi in freespace. This will give you a less optimized solution. It is better to go for a slightly higher freespace peak gain of 3 dBi or more if available. Once that antenna gets integrated into your device, performance will degrade below this 2 dBi peak gain due to the effects of ground plane, surrounding components, and device housing. If you want to be absolutely sure, contact Taoglas and we will test. Choosing a Taoglas antenna with a higher peak gain than what is specified by the module manufacturer and enlisting our help will ensure you are getting the best performance possible without exceeding the peak gain limits.

Contact your regional Taoglas sales office for more information.

## 2. Specification

Electrical				
Frequency (MHz)		2400	2450	2500
Efficiency (%)				
In free space		33.30	30.36	29.65
10X10cm ground plane	center	63.43	71.44	66.85
	edge	55.85	68.43	61.73
20X20cm ground plane	center	64.20	71.40	63.97
	edge	62.55	81.30	69.73
30X30cm ground plane	center	58.31	70.49	60.87
	edge	62.11	73.46	61.90
Average gain (dBi)				
In free space		-4.78	-5.18	-5.28
10X10cm ground plane	center	-1.98	-1.46	-1.75
	edge	-2.53	-1.65	-2.10
20X20cm ground plane	center	-1.92	-1.46	-1.94
	edge	-2.04	-0.90	-1.57
30X30cm ground plane	center	-2.34	-1.52	-2.16
	edge	-2.07	-1.34	-2.08
Peak gain (dBi)				
In free space		0.89	0.40	0.12
10X10cm ground plan	center	2.02	2.45	2.37
	edge	3.46	4.09	3.47
20X20cm ground plane	center	4.26	4.54	3.69
	edge	4.02	5.40	4.65
30x30cm ground plane	center	3.64	4.85	4.06
	edge	3.79	4.23	3.15
Return Loss (dB)	<-6			
Radiation	Omni-directional			
Polarization	Linear			
Impedance	50 $\Omega$			
Input Power	10W			

Mechanical	
Antenna Dimension	19.8mm*14.3mm*16.4mm
Casing	ABS
Connector	SMA(M)
Weight	6g
Ingress Protection Rating	IP67
Environmental	
Operation Temperature	-40°C ~ + 85°C
Storage Temperature	-40°C ~ + 85°C
Humidity	Non-condensing 65°C 95% RH

### 3. Antenna Characteristics

#### 3.1 Testing Setup

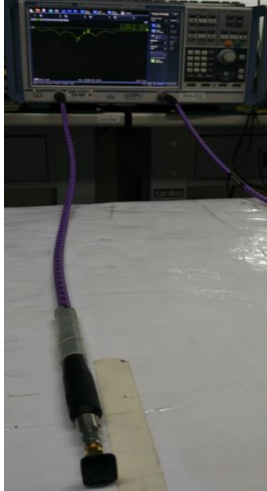

a) In free space

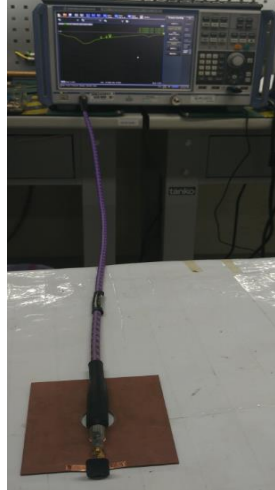

b) 10\*10cm ground plane center

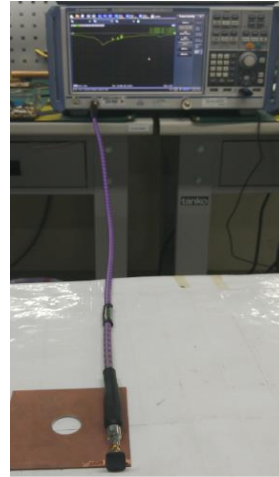

c) 10\*10cm ground plane edge

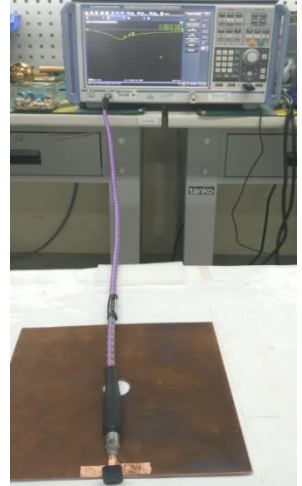

d) 20\*20cm ground plane center

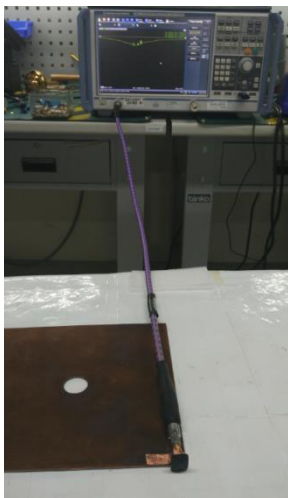

e) 20\*20cm ground plane edge

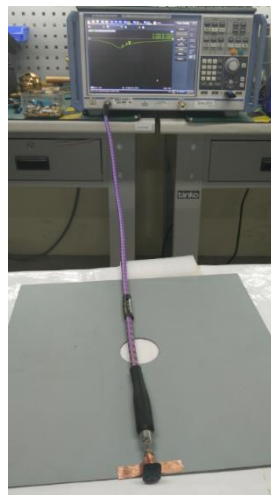

f) 30\*30cm ground plane center



g) 30\*30cm ground plane edge

**Figure.1** Antenna Measurement Setup

### 3.2 Return Loss (In free space)

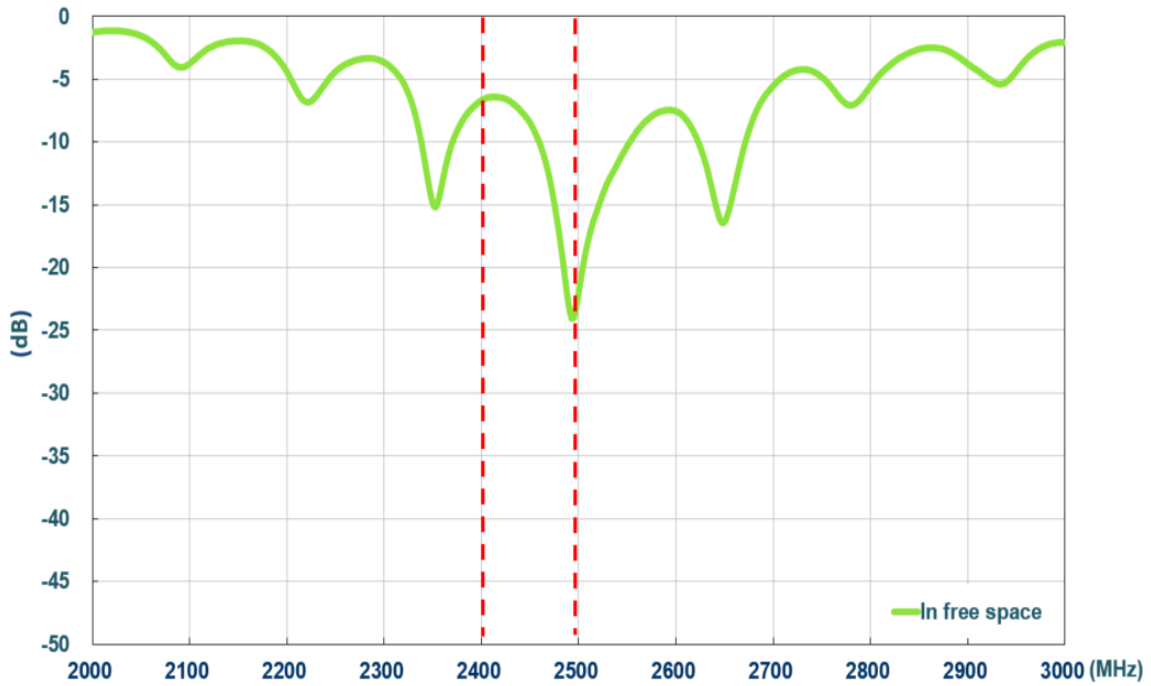

**Figure 2.** Return loss of WCM.01 in free space

### 3.3 Return Loss (On the ground plane center)

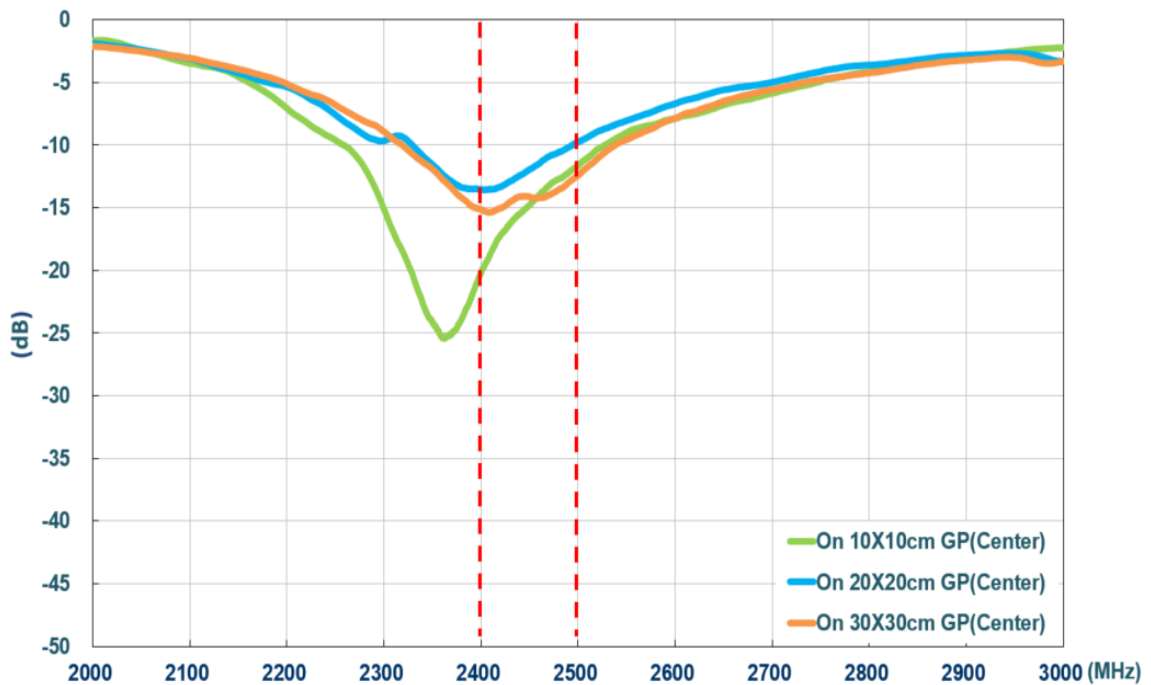

**Figure 3.** Return loss of WCM.01 on center of different ground plane sizes

### 3.4 Return Loss (On ground plane edge)

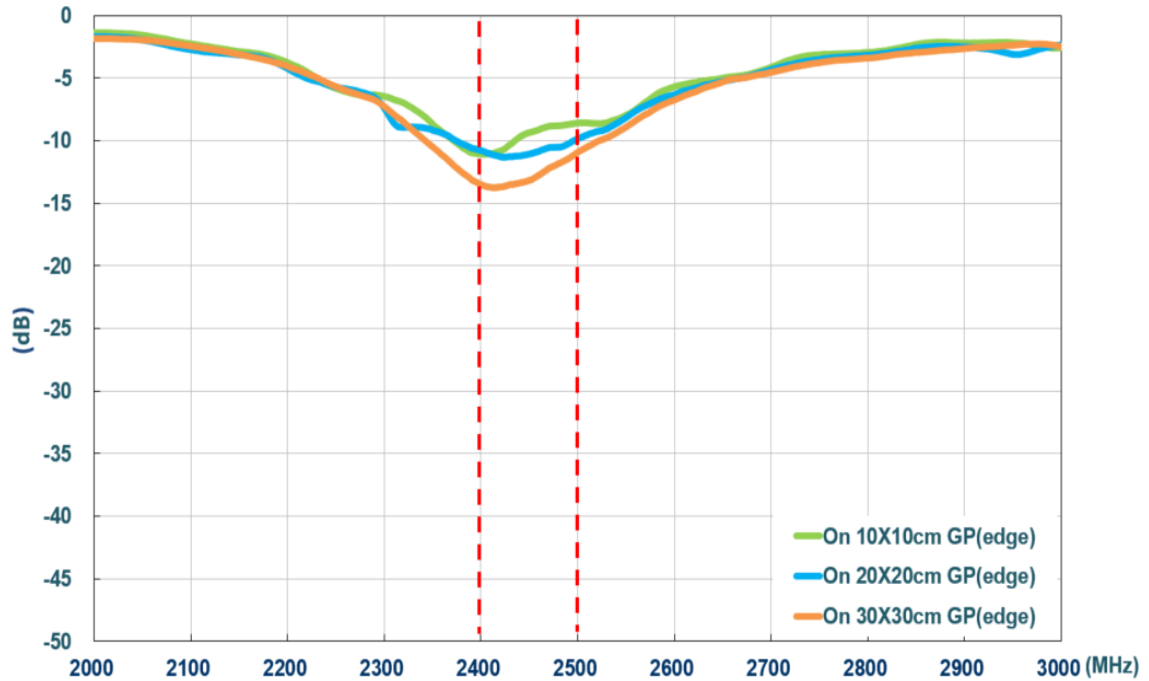

**Figure 4.** Return loss of WCM.01 on edge of different ground plane sizes

### 3.5 Efficiency (Free space)

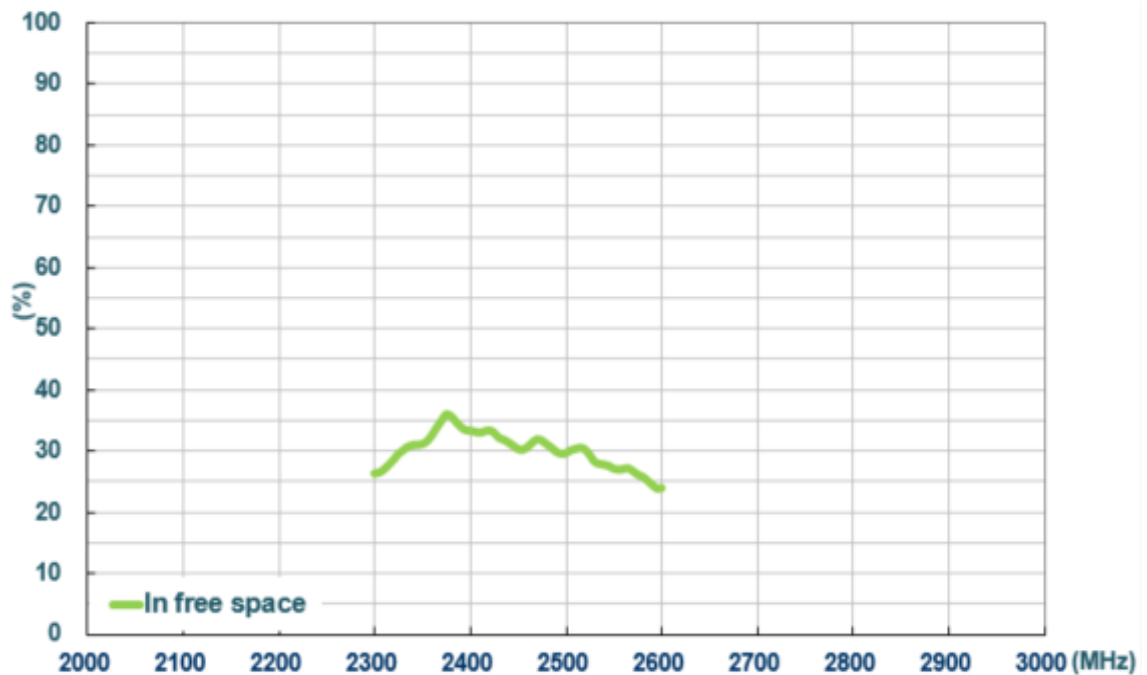

**Figure 5.** Efficiency of WCM.01 antenna in free space



### 3.6 Efficiency (On ground plane center)

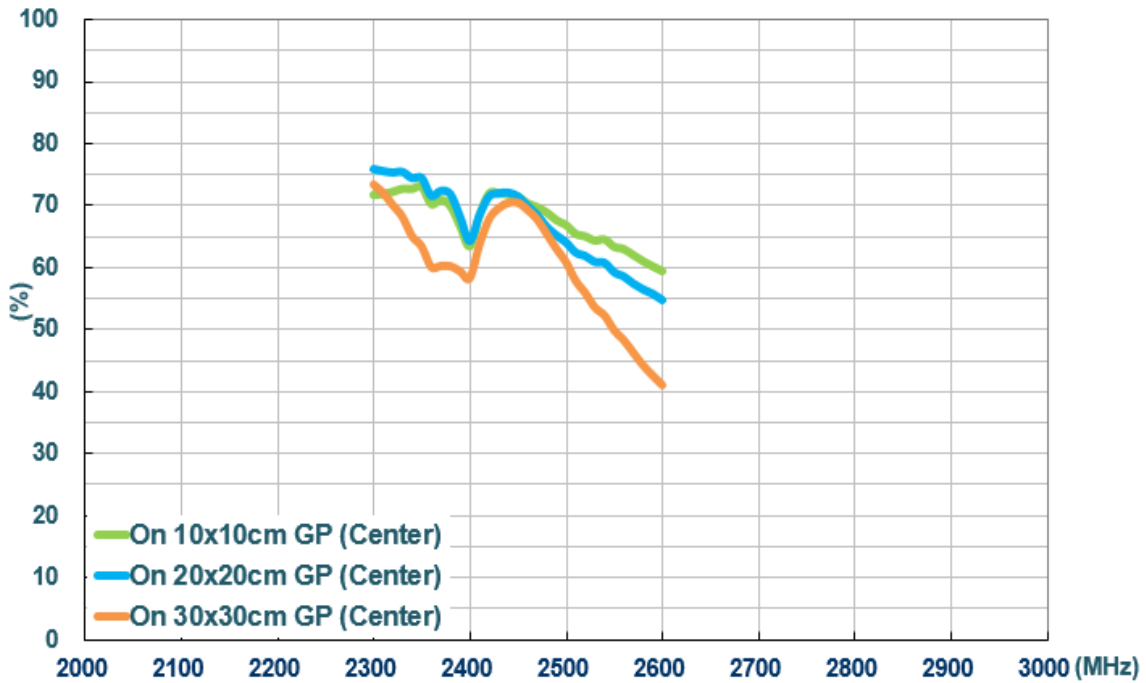

**Figure 6.** Efficiency of WCM.01 on center of different ground plane sizes

### 3.7 Efficiency (On ground plane edge)

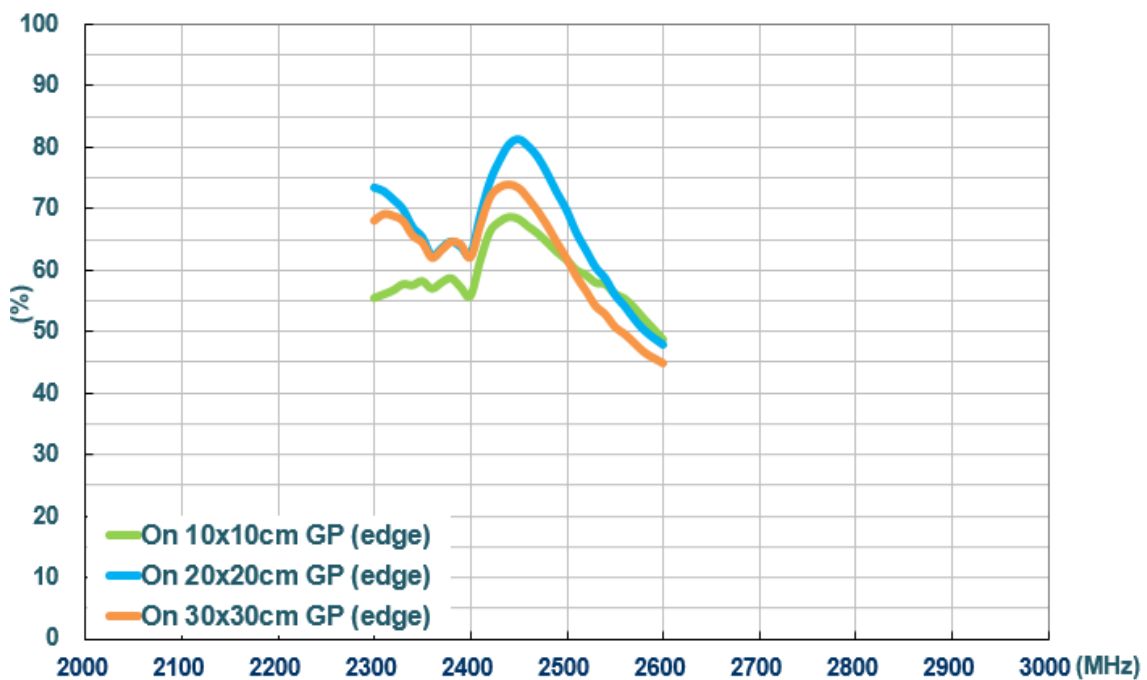

**Figure 7.** Efficiency of WCM.01 on edge of different ground plane sizes

### 3.8 Peak Gain (Free space)

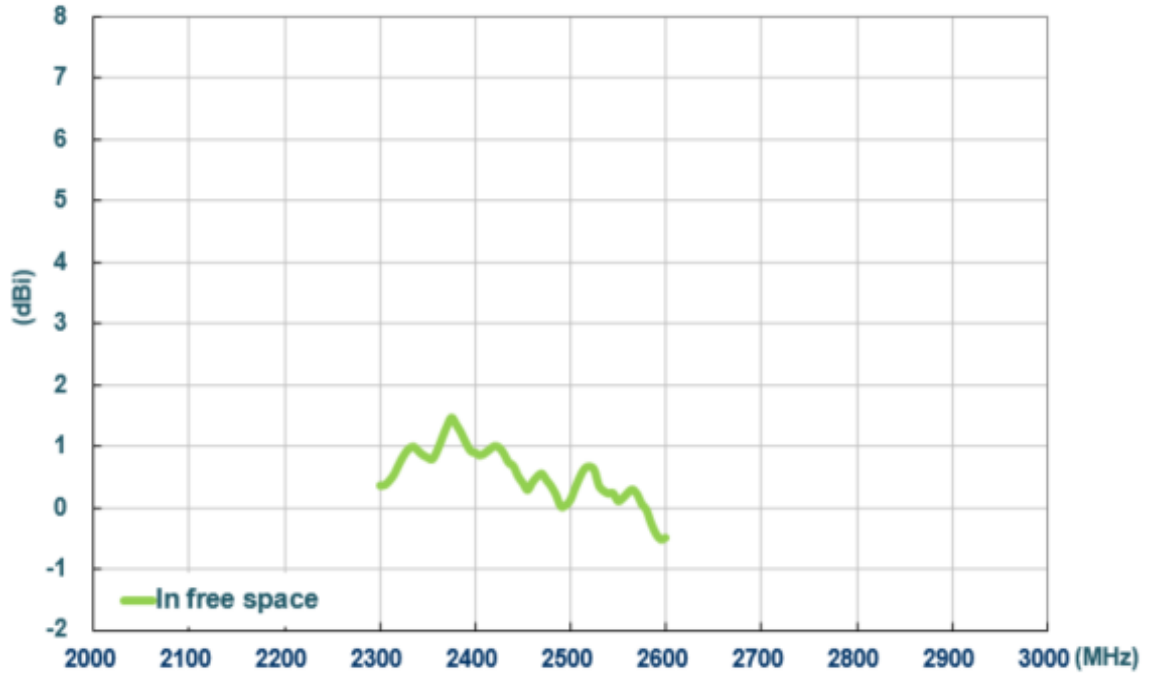

**Figure 8.** Peak gain of WCM.01 antenna in free space

### 3.9 Peak Gain (On ground plane center)

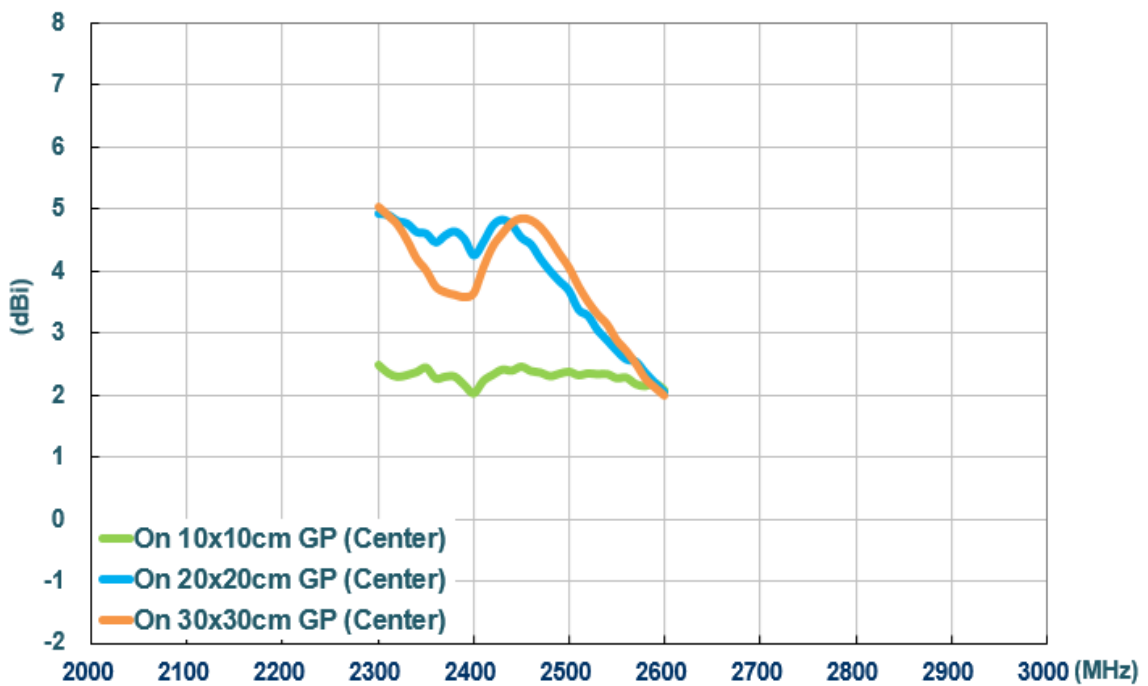

**Figure 9.** Peak gain of WCM.01 on center of different ground plane sizes

### 3.10 Peak Gain (On ground plane edge)

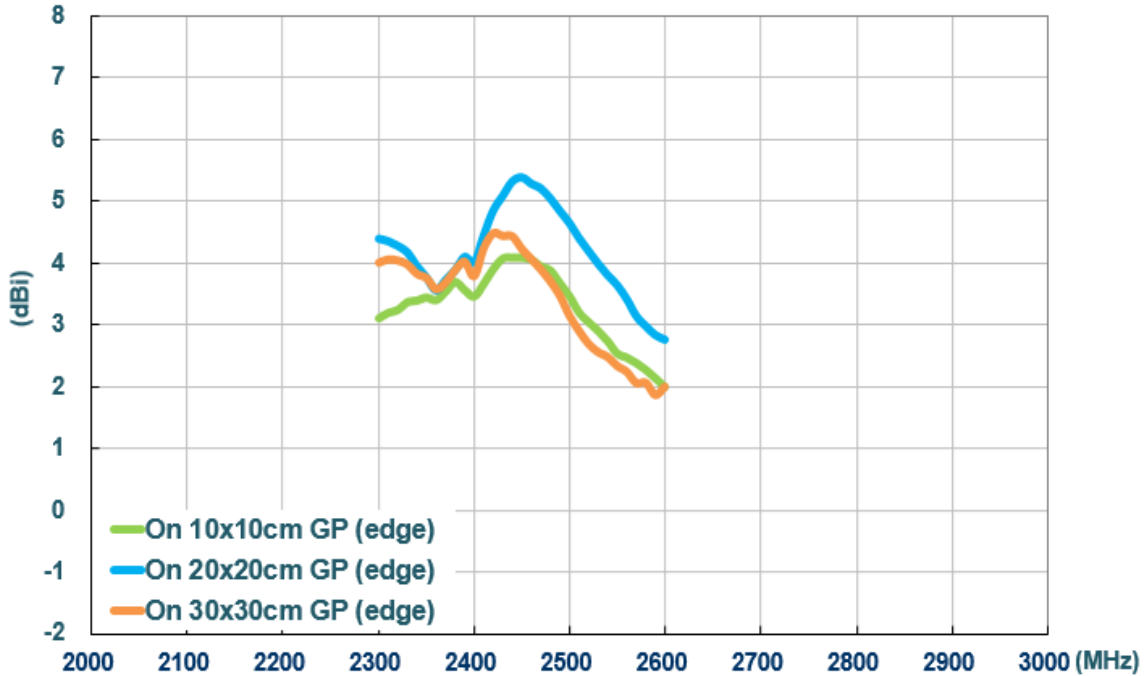

**Figure 10.** Peak gain of WCM.01 on edge of different ground plane sizes

### 3.11 Average Gain (Free space)

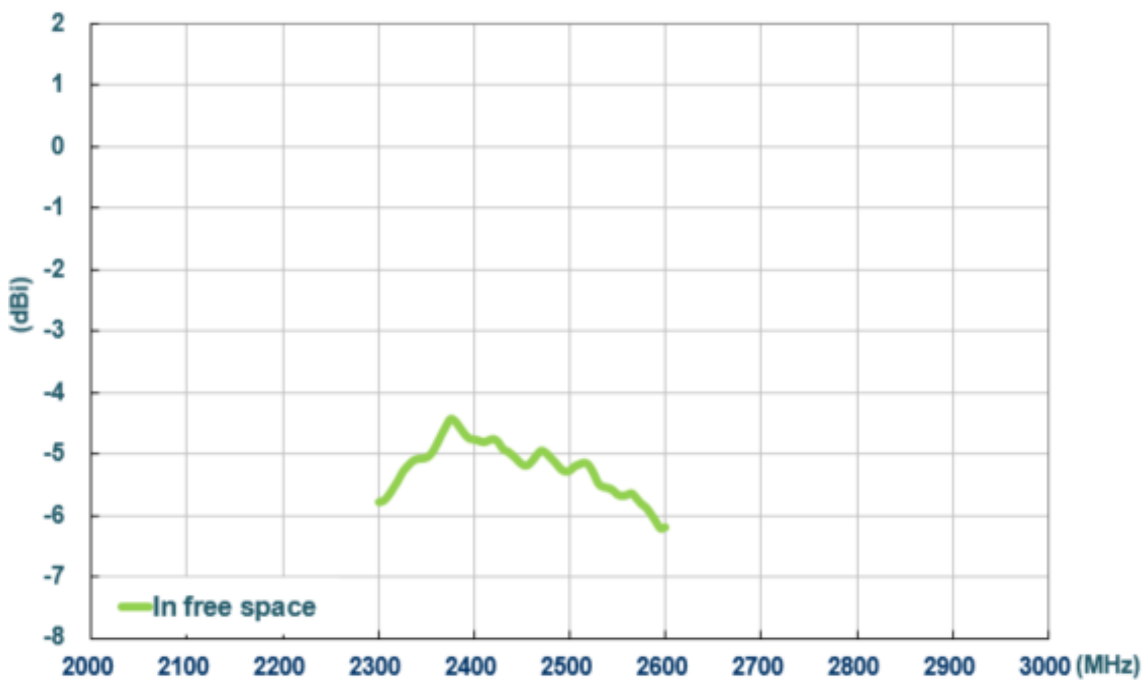

**Figure 11.** Average gain of WCM.01 in free space

### 3.12 Average Gain (On ground plane center)

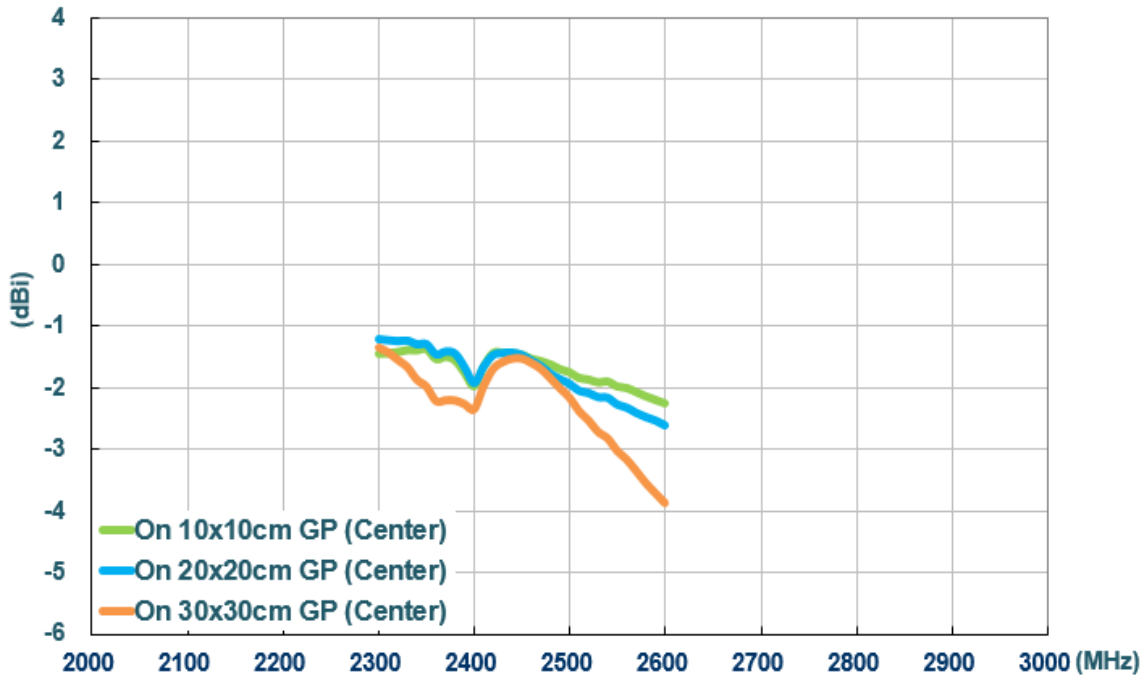

**Figure 12.** Average gain of WCM.01 on center of different ground plane sizes

### 3.13 Average Gain (On ground plane edge)

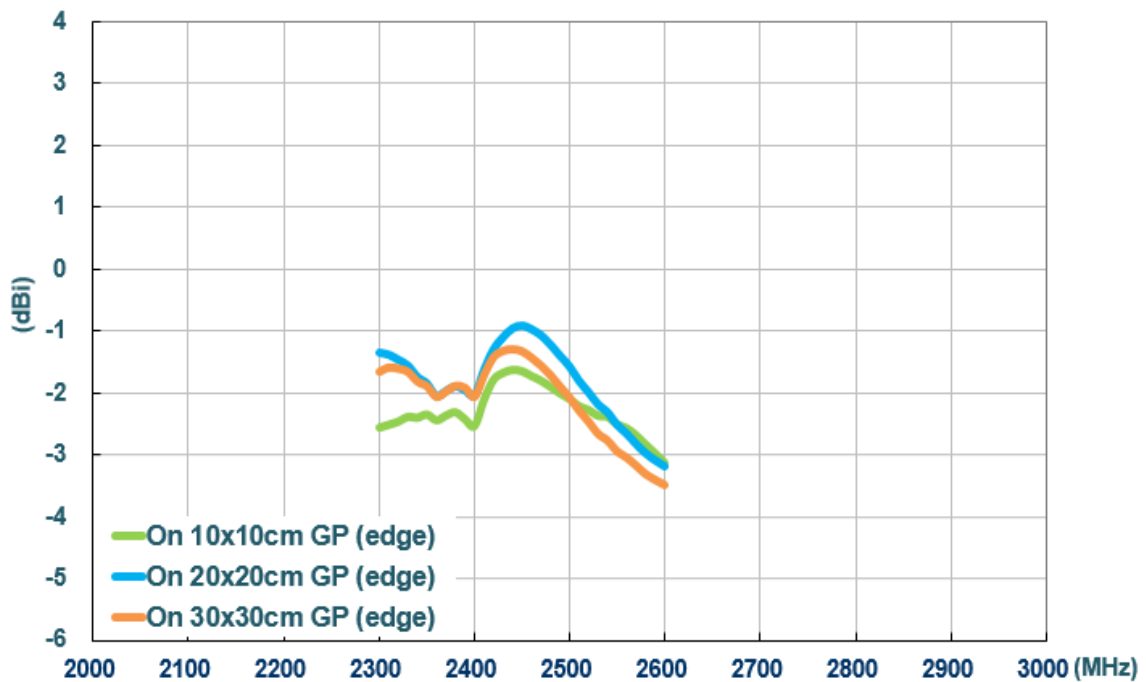

**Figure 13.** Average gain of WCM.01 on edge of different ground plane sizes

## 4. Antenna Radiation Patterns

The antenna radiation patterns were measured in CTIA certified ETS Anechoic Chamber. The measurement setup as below,

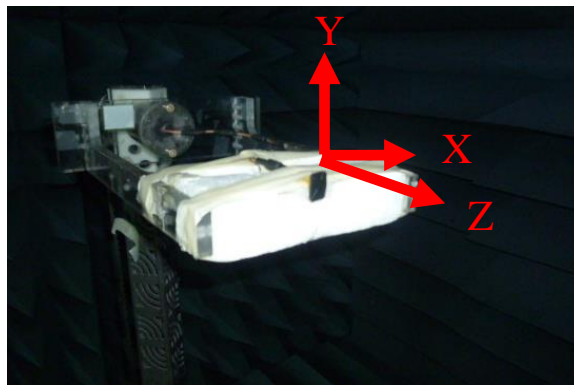

Free space

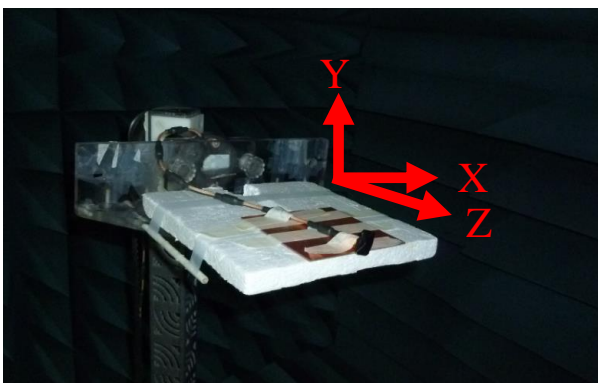

On 10X10cm ground plane center

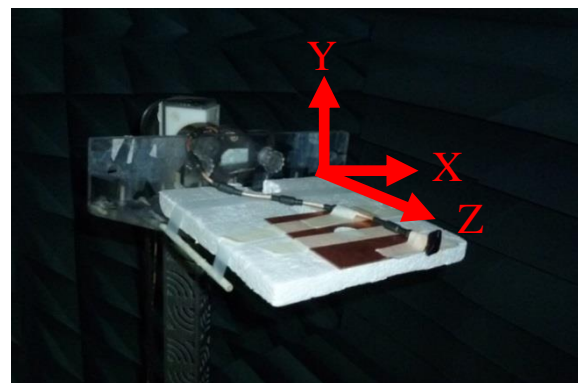

On 10X10cm ground plane edge

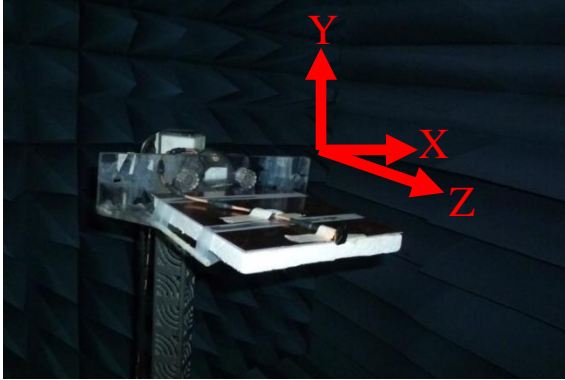

On 20X20cm ground plane (Center)

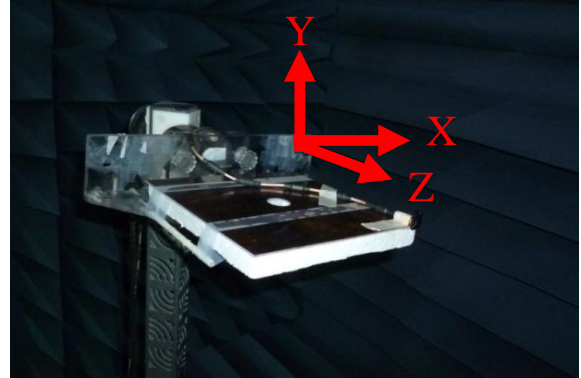

On 20X20cm ground plane (Edge)

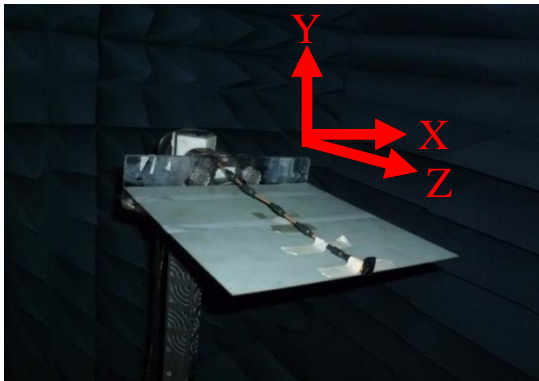

On 30X30cm ground plane (Center)



On 30X30cm ground plane (Edge)

**Figure.14.** Testing Setup in ETS Anechoic Chamber

## 4.1 2D Radiation Pattern (free space)

XY Plane

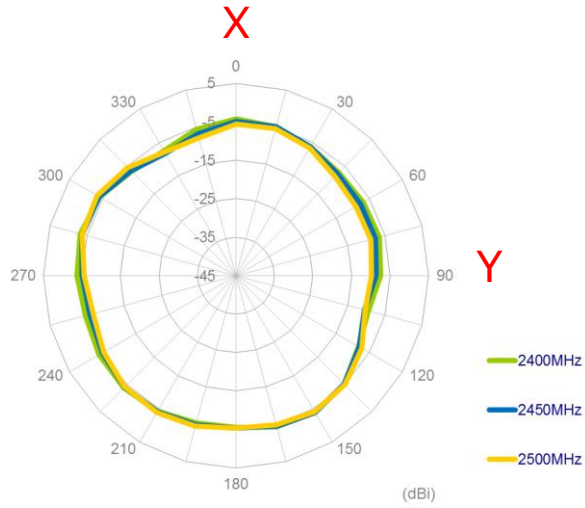

XZ Plane

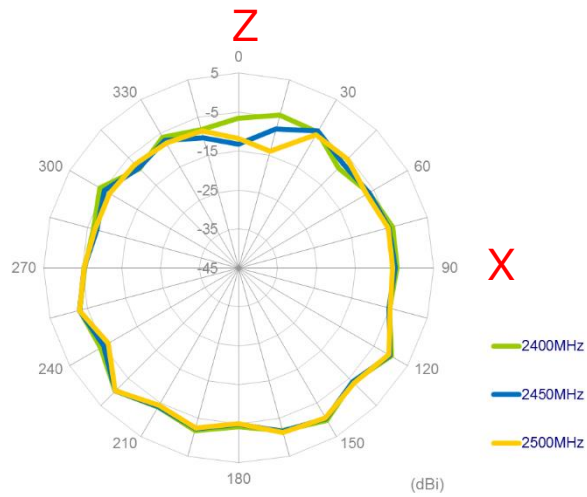

YZ Plane

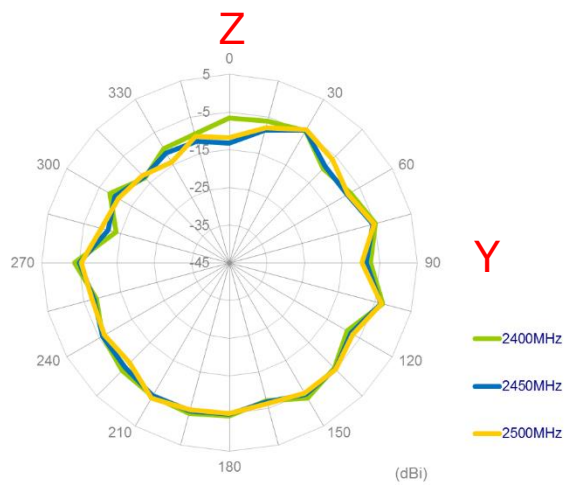

## 4.2 3D Radiation Pattern (free space)

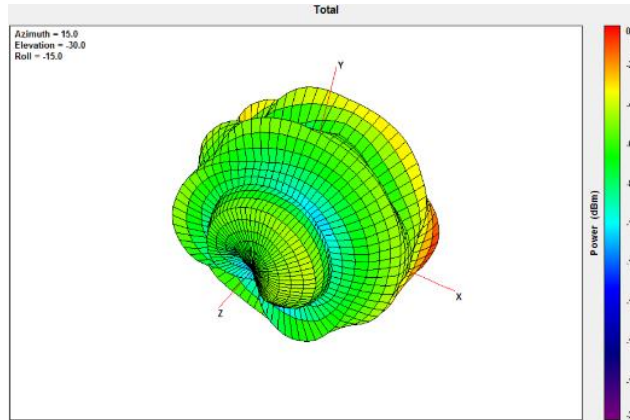

2400MHz

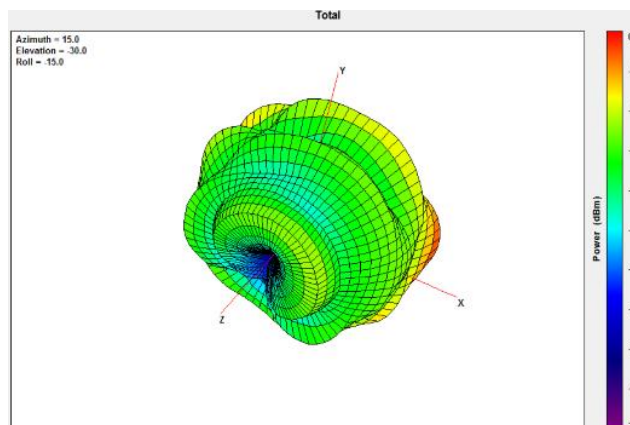

2450MHz

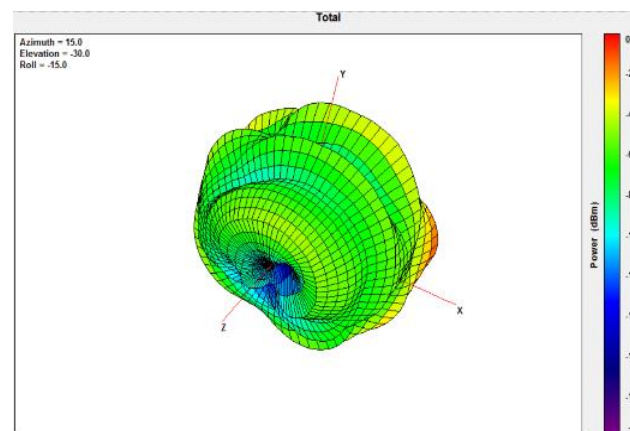

2500MHz



### 4.3 2D Radiation Pattern (On 10X10cm ground plane center)

XY Plane

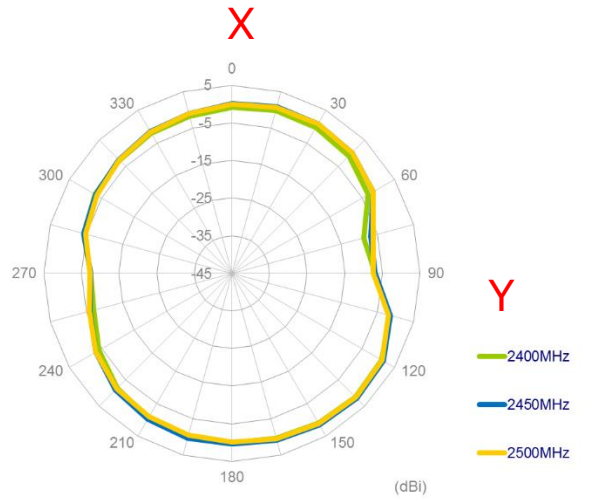

XZ Plane

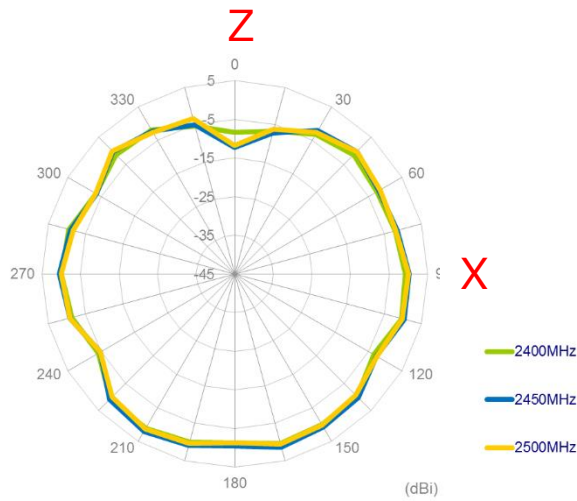

YZ Plane

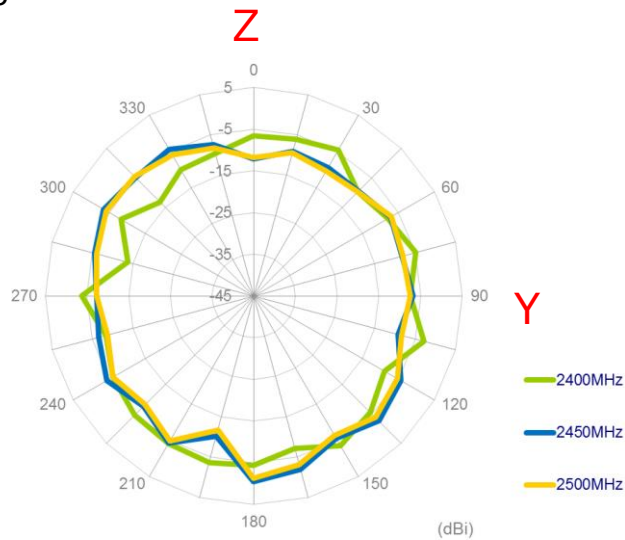

### 4.4 3D Radiation Pattern (On 10X10cm ground plane center)

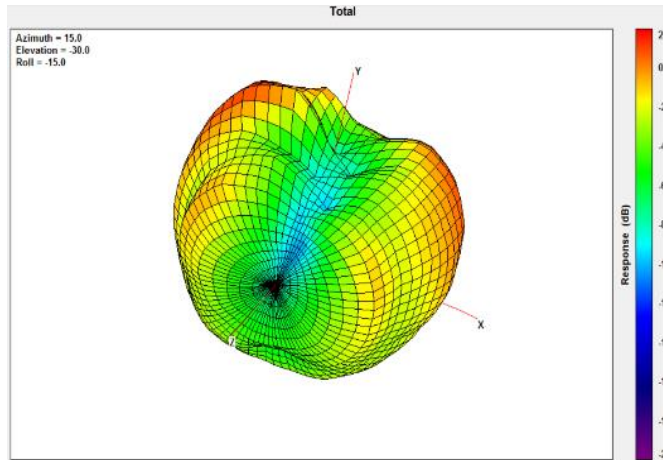

2400MHz

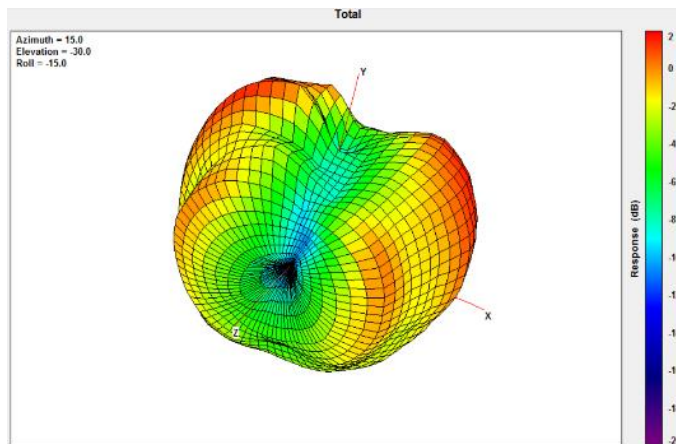

2450MHz

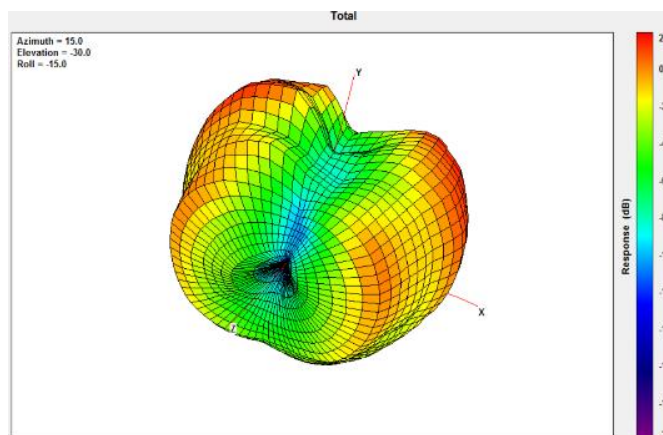

2500MHz

## 4.5 2D Radiation Pattern (On 10X10cm ground plane edge)

XY Plane

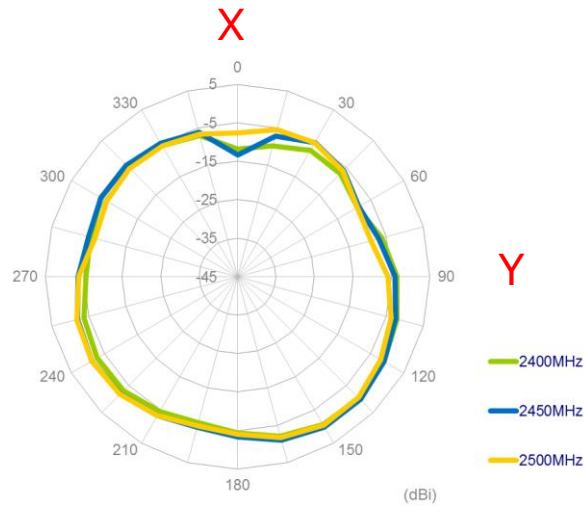

XZ Plane

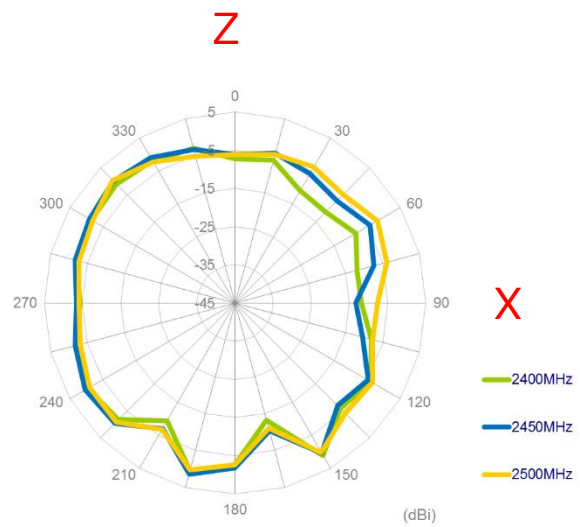

YZ Plane

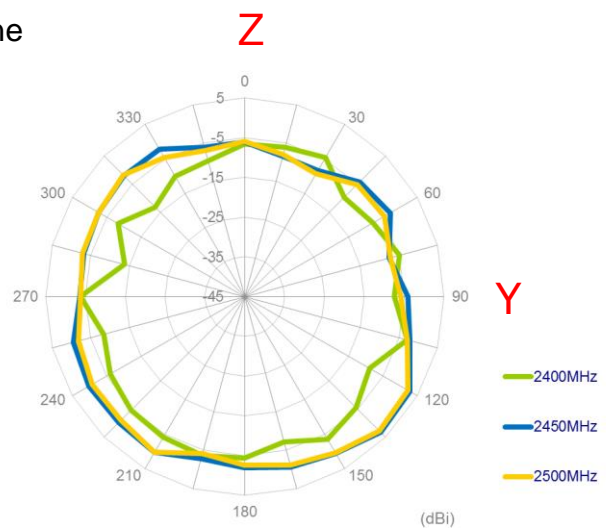

### 4.6 3D Radiation Pattern (On 10X10cm ground plane edge)

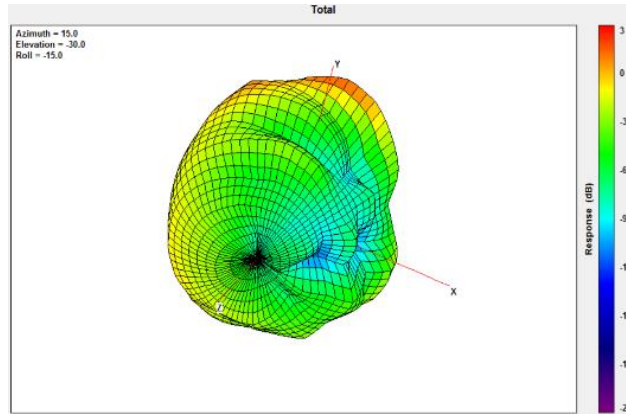

2400MHz

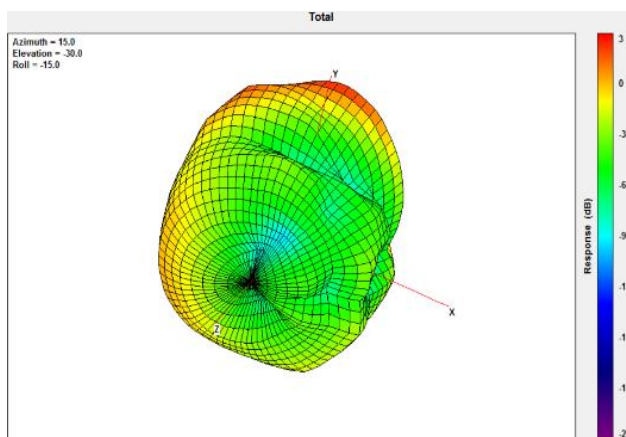

2450MHz

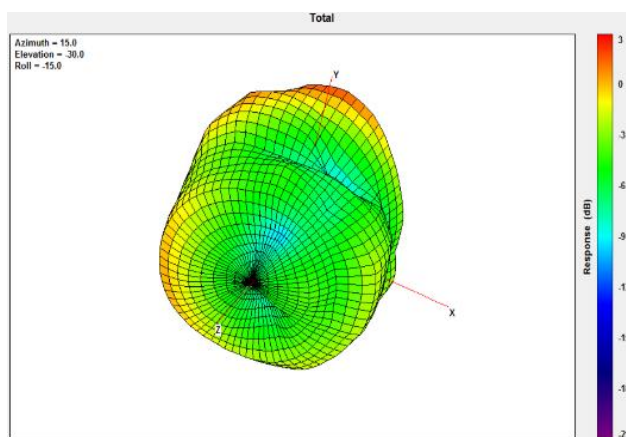

2500MHz

## 4.7 2D Radiation Pattern (On 20X20cm ground plane center)

XY Plane

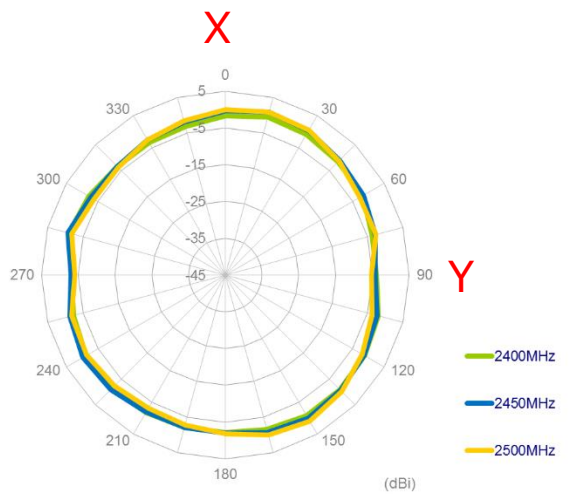

XZ Plane

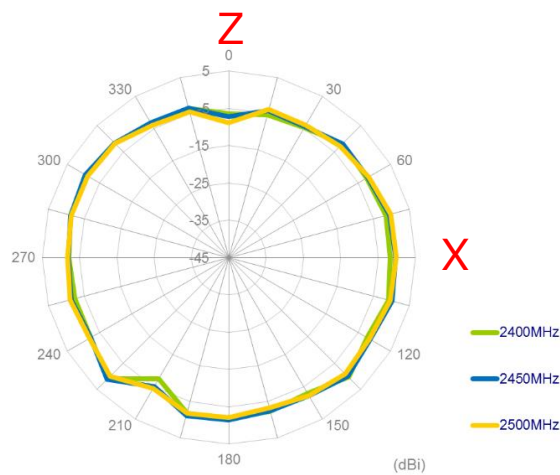

YZ Plane

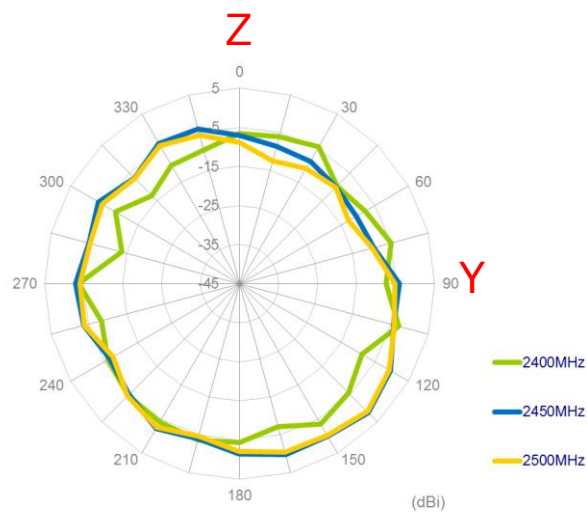

### 4.8 3D Radiation Pattern (On 20X20cm ground plane center)

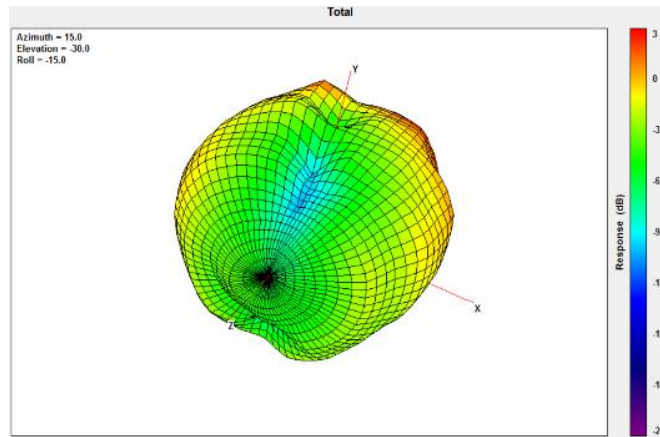

2400MHz

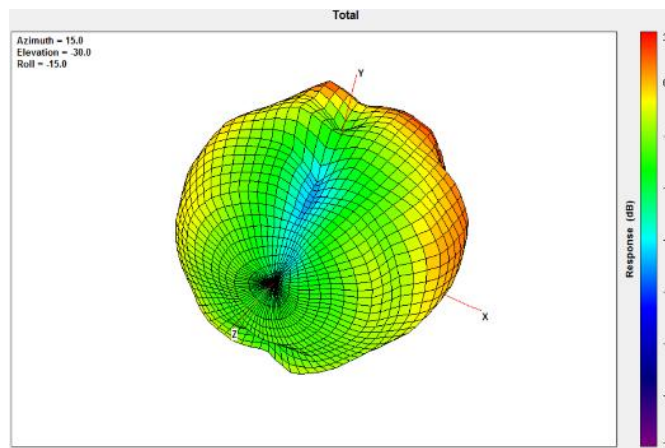

2450MHz

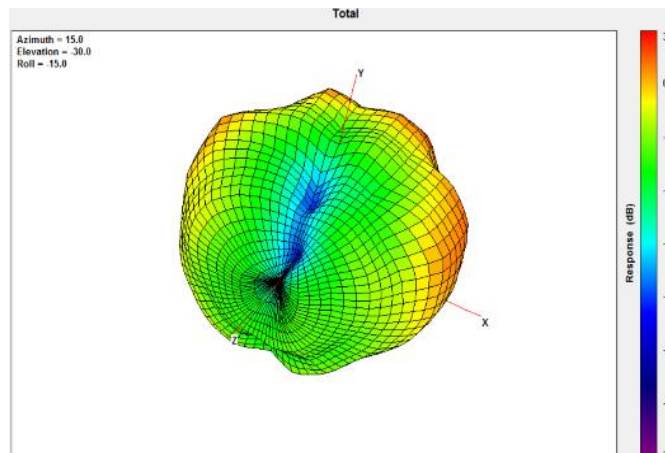

2500MHz



## 4.9 2D Radiation Pattern (On 20X20cm ground plane edge)

XY Plane

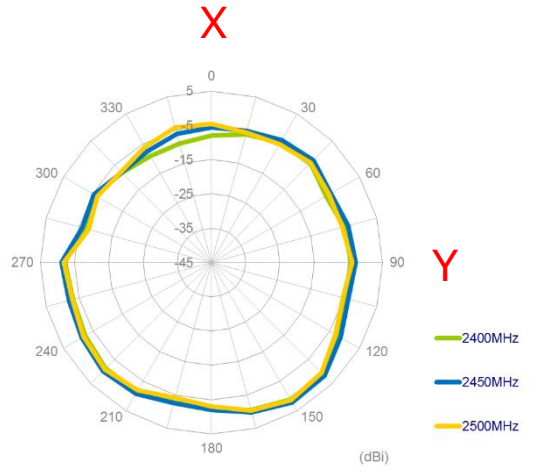

XZ Plane

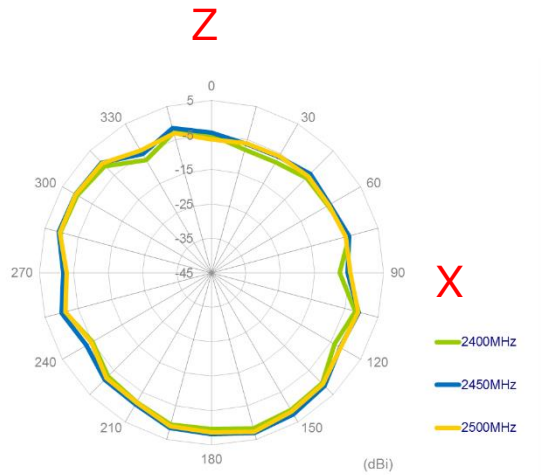

YZ Plane

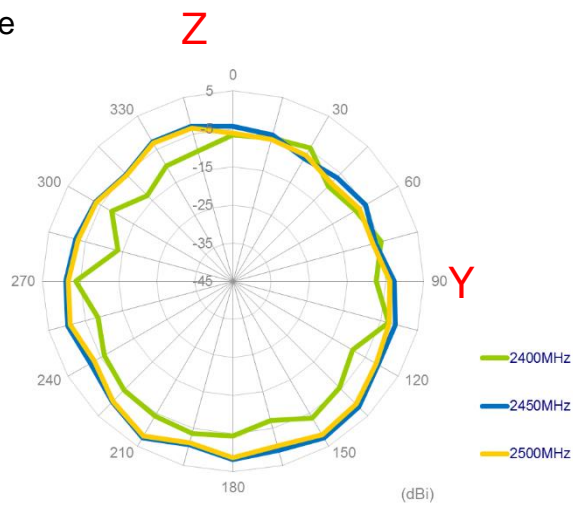

### 4.10 3D Radiation Pattern (On 20X20cm ground plane edge)

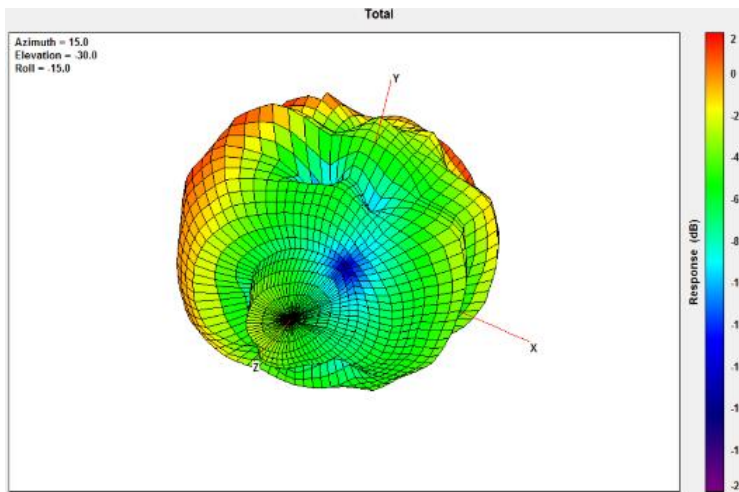

2400MHz

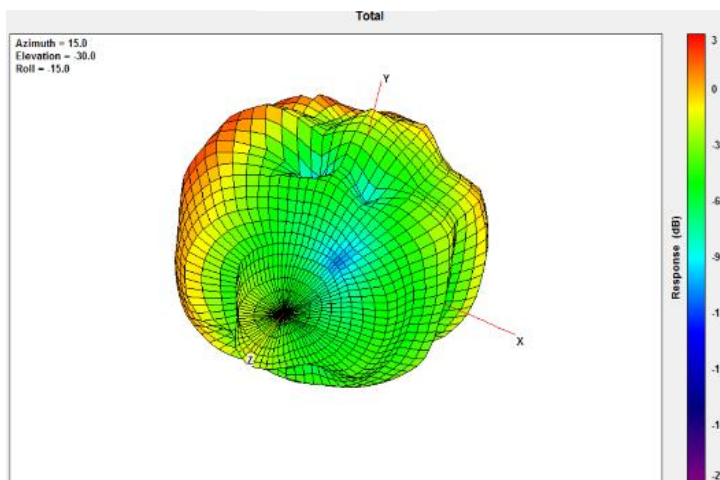

2450MHz

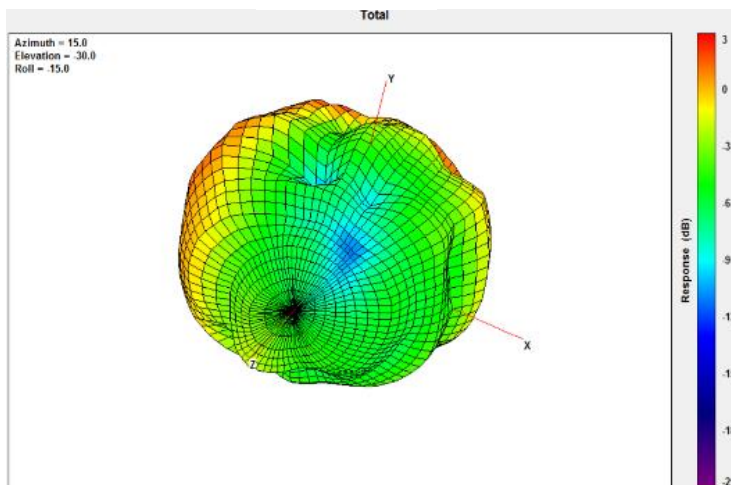

2500MHz



### 4.11 2D Radiation Pattern (On 30X30cm ground plane center)

XY Plane

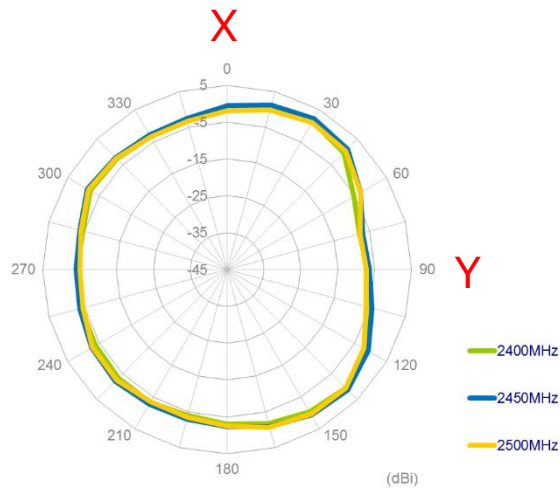

XZ Plane

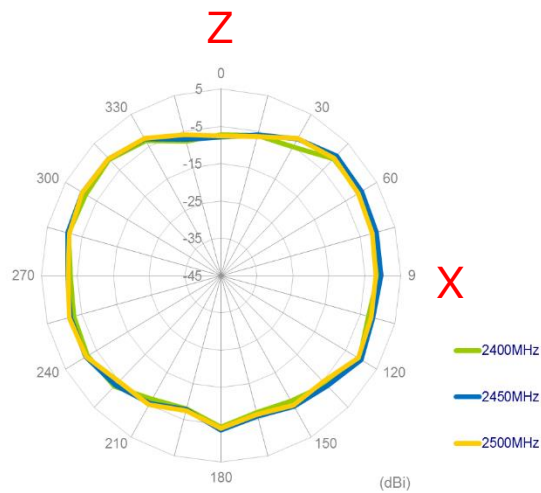

YZ Plane

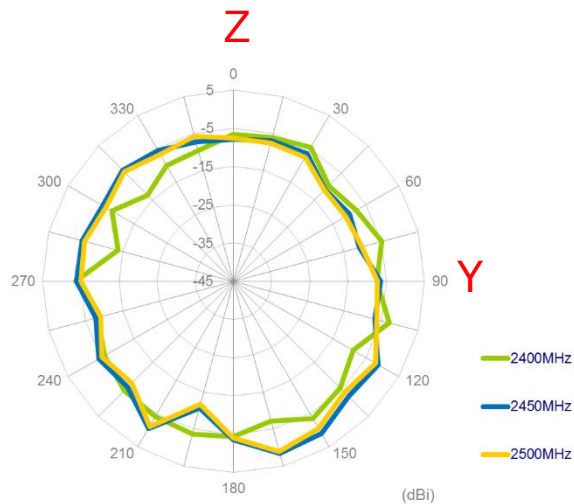

### 4.12 3D Radiation Pattern (On 30X30cm ground plane center)

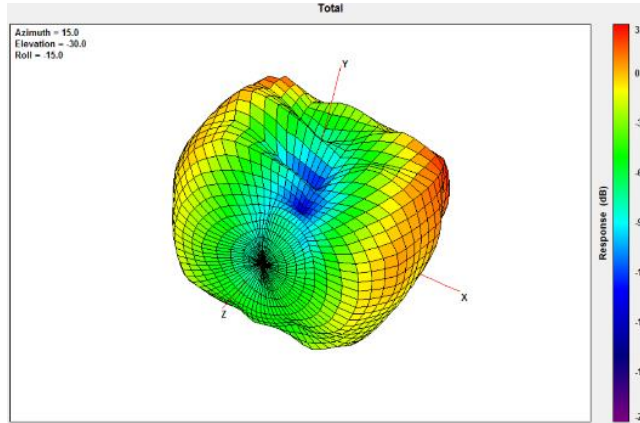

2400MHz

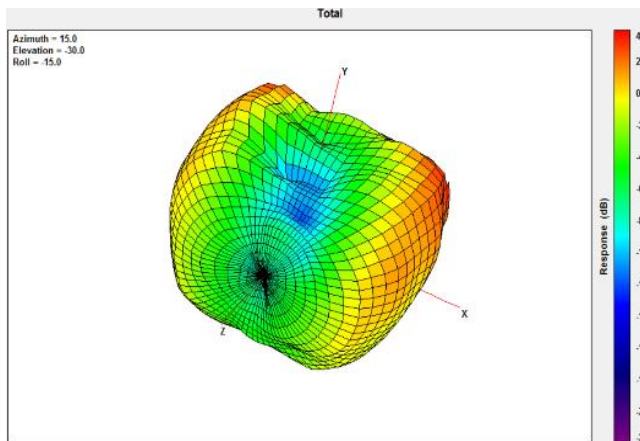

2450MHz

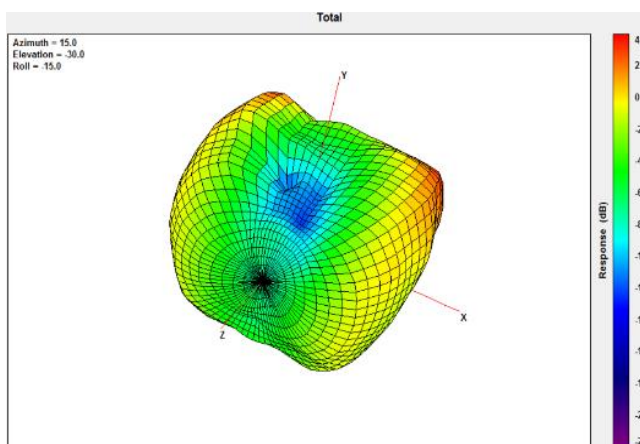

2500MHz

**4.13 2D Radiation Pattern (On 30X30cm ground plane edge)**

XY Plane

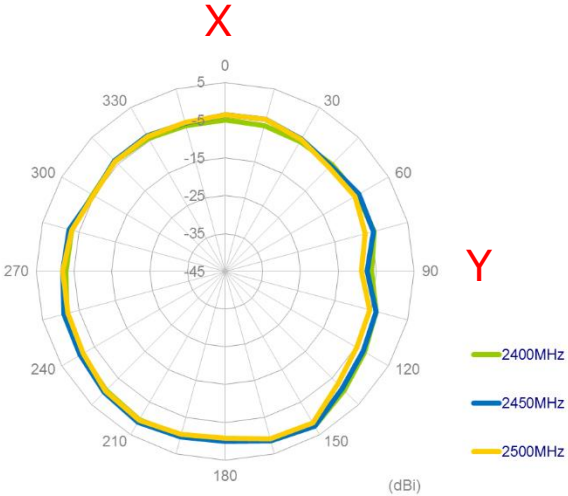

XZ Plane

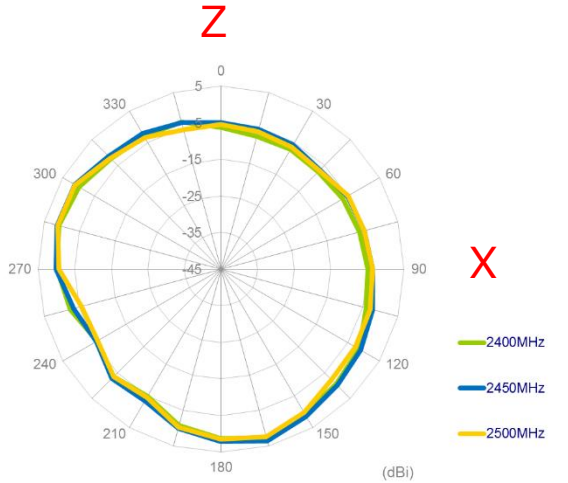

YZ Plane

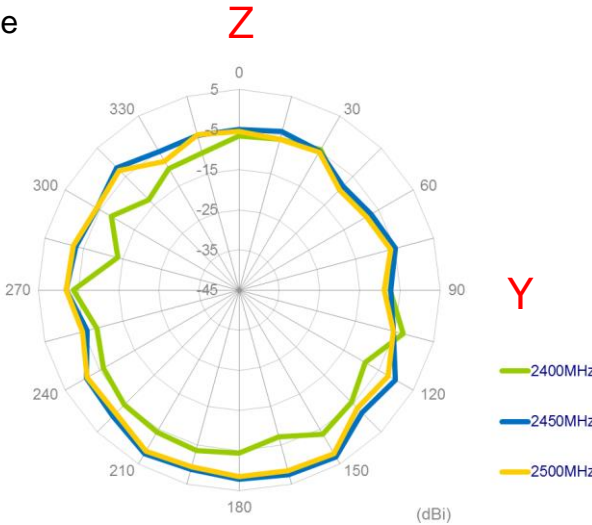

### 4.14 3D Radiation Pattern (On 30X30cm ground plane edge)

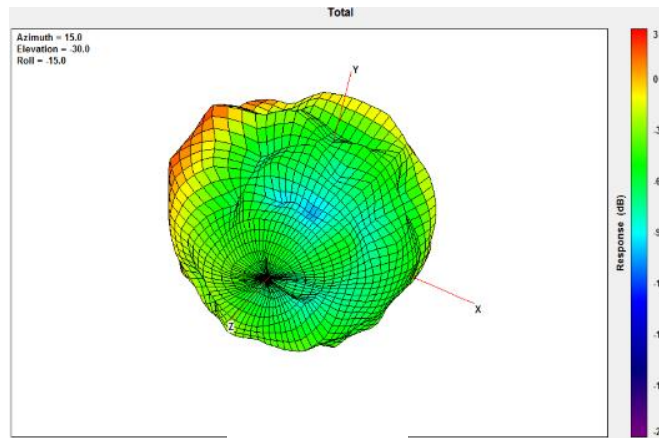

2400MHz

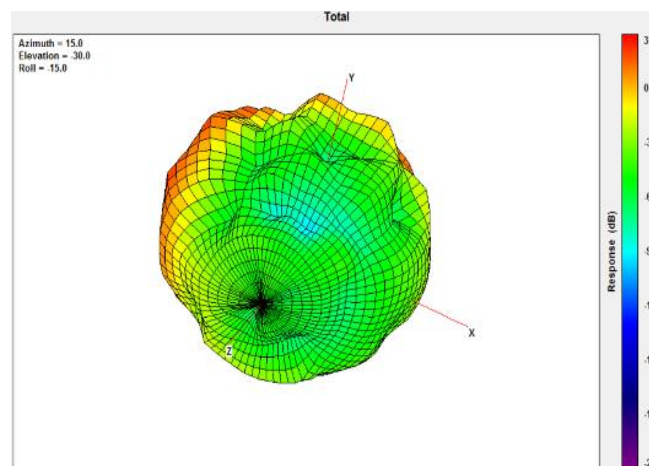

2450MHz

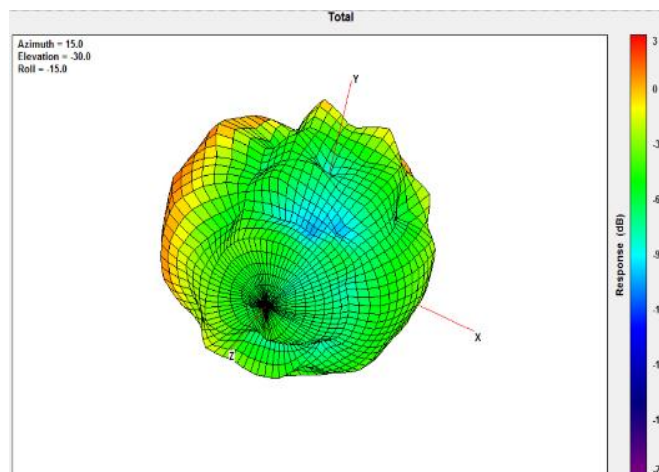

2500MHz

## 5. Mechanical Drawing (unit: mm)



3D View

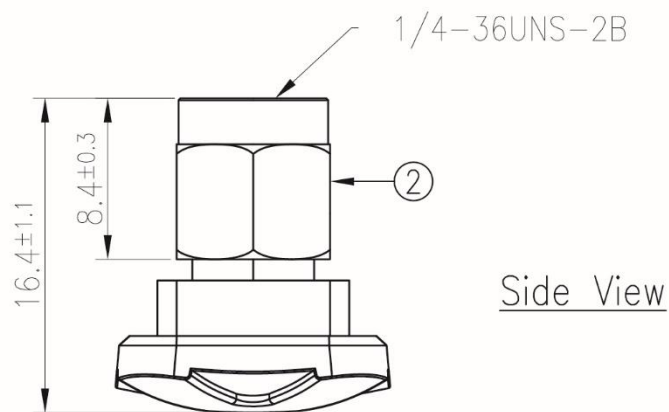
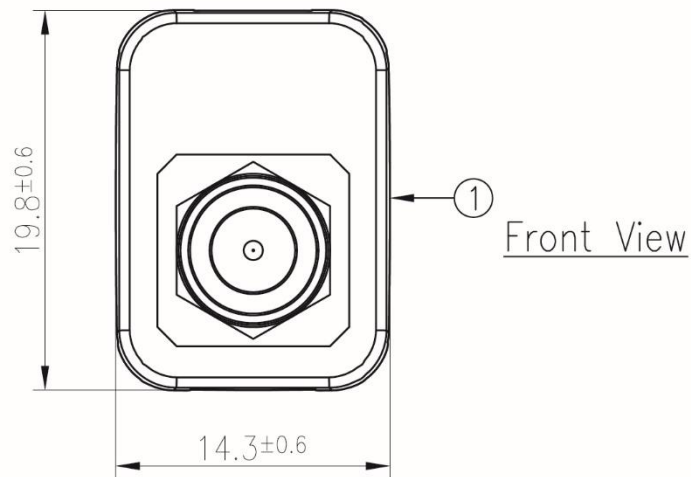

	Name	Material	Finish	QTY
1	External housing	ABS	Black	1
2	SMA(M)	Brass	Au Plated	1

## 6. Packaging

1 pc WCM.01.0111 per PE Bag  
 PE Bag Dimensions - 80\*40mm  
 Weight - 7g

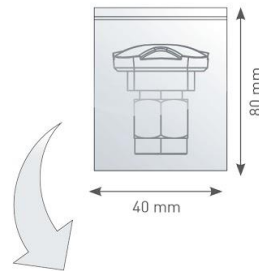

100 PE Bags per Large PE Bag  
 100 pcs WCM.01.0111 per Large PE Bag  
 Large Polybag Dimensions - 240\*170mm  
 Weight - 0.7kg

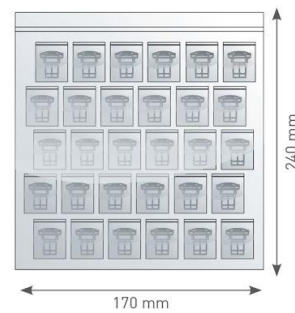

15 Large PE bags per carton  
 1500 pcs WCM.01.0111 per carton  
 Carton Dimensions - 360\*310\*160mm  
 Weight - 11kg

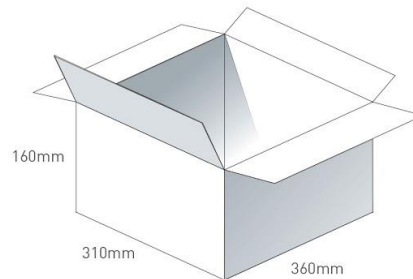

Pallet Dimensions 1080mm\*930mm\*1430mm  
 72 Cartons per Pallet  
 12 Cartons per layer  
 6 Layers

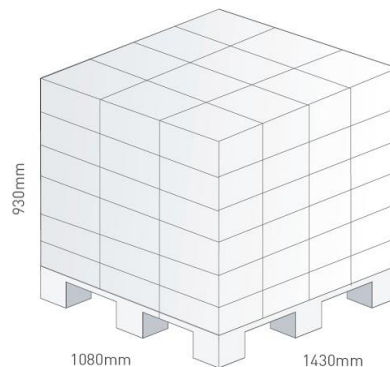

Taoglas makes no warranties based on the accuracy or completeness of the contents of this document and reserves the right to make changes to specifications and product descriptions at any time without notice.

Taoglas reserves the rights to this document and the information contained herein. Reproduction, use or disclosure to third parties without express permission is strictly prohibited.

Copyright © Taoglas Ltd.

## Данный компонент на территории Российской Федерации

### Вы можете приобрести в компании MosChip.

Для оперативного оформления запроса Вам необходимо перейти по данной ссылке:

<http://moschip.ru/get-element>

Вы можете разместить у нас заказ для любого Вашего проекта, будь то серийное производство или разработка единичного прибора.

В нашем ассортименте представлены ведущие мировые производители активных и пассивных электронных компонентов.

Нашей специализацией является поставка электронной компонентной базы двойного назначения, продукции таких производителей как XILINX, Intel (ex.ALTERA), Vicor, Microchip, Texas Instruments, Analog Devices, Mini-Circuits, Amphenol, Glenair.

Сотрудничество с глобальными дистрибьюторами электронных компонентов, предоставляет возможность заказывать и получать с международных складов практически любой перечень компонентов в оптимальные для Вас сроки.

На всех этапах разработки и производства наши партнеры могут получить квалифицированную поддержку опытных инженеров.

Система менеджмента качества компании отвечает требованиям в соответствии с ГОСТ Р ИСО 9001, ГОСТ РВ 0015-002 и ЭС РД 009

### Офис по работе с юридическими лицами:

105318, г.Москва, ул.Щербаковская д.3, офис 1107, 1118, ДЦ «Щербаковский»

Телефон: +7 495 668-12-70 (многоканальный)

Факс: +7 495 668-12-70 (доб.304)

E-mail: [info@moschip.ru](mailto:info@moschip.ru)

Skype отдела продаж:

moschip.ru

moschip.ru\_4

moschip.ru\_6

moschip.ru\_9