

## Automotive 600 W TVS in SMB

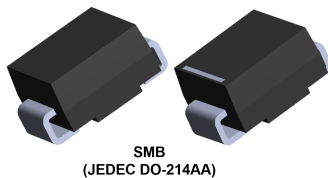

Bidirectional



Unidirectional

## Features

- AEC-Q101 qualified 
- Peak pulse power: 600 W (10/1000  $\mu$ s) and 4 kW (8/20  $\mu$ s)
- Stand-off voltage range from 5 V to 188 V
- Unidirectional and bidirectional types
- Low leakage current: 0.2  $\mu$ A at 25 °C and 1  $\mu$ A at 85 °C
- Operating  $T_j$  max: 150 °C
- High power capability at  $T_j$  max.: up to 515 W (10/1000  $\mu$ s)
- Lead finishing: matte tin plating

## Complies with the following standards

- UL94, V0
- J-STD-020 MSL level 1
- J-STD-002, JESD 22-B102 E3 and MIL-STD-750, method 2026 solderable matte tin plated leads
- JESD-201 class 2 whisker test
- IPC7531 footprint
- JEDEC registered package outline
- IEC 61000-4-4 level 4:
  - 4 kV
- ISO10605, IEC 61000-4-2, C= 150 pF - R = 330  $\Omega$  exceeds level 4:
  - 30 kV (air discharge)
  - 30 kV (contact discharge)
- ISO10605 - C = 330 pF, R = 330  $\Omega$  exceeds level 4:
  - 30 kV (air discharge)
  - 30 kV (contact discharge)
- ISO7637-2 (Not applicable to parts with stand-off voltage lower than battery voltage)
  - Pulse1:  $V_S = -150$  V
  - Pulse 2a:  $V_S = +112$  V
  - Pulse 3a:  $V_S = -220$  V
  - Pulse 3b:  $V_S = +150$  V

## Description

The SM6TY series are designed to protect sensitive automotive circuits against surges defined in ISO 7637-2 and against electrostatic discharges according to ISO 10605.

The Planar technology makes it compatible with high-end circuits where low leakage current and high junction temperature are required to provide long term reliability and stability.

Product status link	
SM6TY	<a href="#">SM6T6V8AY</a> , <a href="#">SM6T6V8CAY</a> , <a href="#">SM6T7V5AY</a> , <a href="#">SM6T7V5CAY</a> , <a href="#">SM6T10AY</a> , <a href="#">SM6T10CAY</a> , <a href="#">SM6T12AY</a> , <a href="#">SM6T12CAY</a> , <a href="#">SM6T15AY</a> , <a href="#">SM6T15CAY</a> , <a href="#">SM6T16V5AY</a> , <a href="#">SM6T16V5CAY</a> , <a href="#">SM6T18AY</a> , <a href="#">SM6T18CAY</a> , <a href="#">SM6T22AY</a> , <a href="#">SM6T22CAY</a> , <a href="#">SM6T24AY</a> , <a href="#">SM6T24CAY</a> , <a href="#">SM6T27AY</a> , <a href="#">SM6T27CAY</a> , <a href="#">SM6T30AY</a> , <a href="#">SM6T30CAY</a> , <a href="#">SM6T33AY</a> , <a href="#">SM6T33CAY</a> , <a href="#">SM6T36AY</a> , <a href="#">SM6T36CAY</a> , <a href="#">SM6T39AY</a> , <a href="#">SM6T39CAY</a> , <a href="#">SM6T42AY</a> , <a href="#">SM6T42CAY</a> , <a href="#">SM6T47AY</a> , <a href="#">SM6T47CAY</a> , <a href="#">SM6T56AY</a> , <a href="#">SM6T56CAY</a> , <a href="#">SM6T68AY</a> , <a href="#">SM6T68CAY</a> , <a href="#">SM6T75AY</a> , <a href="#">SM6T75CAY</a> , <a href="#">SM6T82AY</a> , <a href="#">SM6T82CAY</a>

# 1 Characteristics

**Table 1. Absolute maximum ratings ( $T_{amb} = 25\text{ }^{\circ}\text{C}$ )**

Symbol	Parameter	Value	Unit	
$V_{PP}$	Peak pulse voltage	ISO10605 (C = 330 pF, R = 330 $\Omega$ ):		
		Contact discharge	30	kV
		Air discharge	30	
		ISO10605 / IEC 61000-4-2 (C = 150 pF, R = 330 $\Omega$ ):		
Contact discharge	30			
$P_{PP}$	Peak pulse power dissipation	10/1000 $\mu\text{s}$ , $T_j$ initial = $T_{amb}$		
		600	W	
$T_{stg}$	Storage temperature range	-65 to +150	$^{\circ}\text{C}$	
$T_j$	Operating junction temperature range	-55 to +150	$^{\circ}\text{C}$	
$T_L$	Maximum lead temperature for soldering during 10 s	260	$^{\circ}\text{C}$	

**Figure 2. Electrical characteristics - parameter definitions**

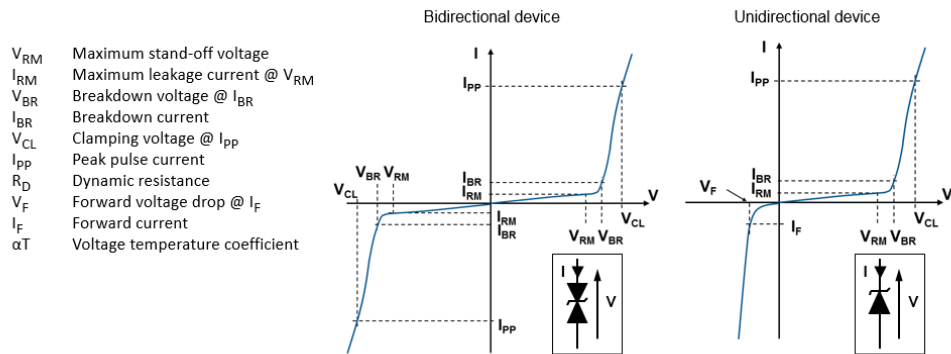

**Figure 3. Pulse definition for electrical characteristics**

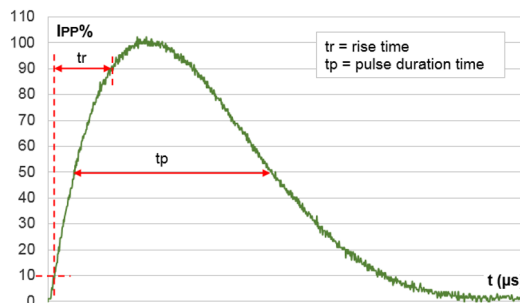

**Table 2. Electrical characteristics - parameter values ( $T_{amb} = 25\text{ °C}$ , unless otherwise specified)**

Type	$I_{RM}$ max at $V_{RM}$			$V_{BR}$ at $I_{BR}^{(1)}$				10 / 1000 $\mu$ s			8 / 20 $\mu$ s			$\alpha T$
								$V_{CL}^{(2)(3)}$	$I_{PP}^{(4)}$	$R_D$	$V_{CL}^{(2)(3)}$	$I_{PP}^{(4)}$	$R_D$	
	25 °C	85 °C		Min.	Typ.	Max.		Max.		Max.	Max.		Max.	
	$\mu$ A	V		V			mA	V	A	$\Omega$	V	A	$\Omega$	$10^{-4}/\text{°C}$
SM6T6V8AY/CAY	20	50	5.80	6.45	6.8	7.14	10	10.5	57	0.059	14.4	275	0.027	5.7
SM6T7V5AY/CAY	20	50	6.40	7.13	7.5	7.88	10	11.3	53	0.065	15.2	266	0.027	6.1
SM6T10AY/CAY	20	50	8.55	9.5	10.0	10.5	1	14.5	41	0.098	18.6	215	0.038	7.3
SM6T12AY/CAY	0.2	1	10.2	11.4	12	12.6	1	16.7	36	0.114	21.7	184	0.049	7.8
SM6T15AY/CAY	0.2	1	12.8	14.3	15	15.8	1	21.2	28	0.193	27.2	147	0.078	8.4
SM6T16V5AY/CAY	0.2	1	14.1	15.7	16.5	17.3	1	23.1	26	0.254	29	136	0.092	8.6
SM6T18AY/CAY	0.2	1	15.3	17.1	18	18.9	1	25.2	24	0.263	32.5	123	0.111	8.8
SM6T22AY/CAY	0.2	1	18.8	20.9	22	23.1	1	30.6	20	0.375	39.3	102	0.159	9.2
SM6T24AY/CAY	0.2	1	20.5	22.8	24	25.2	1	33.2	18	0.444	42.8	93	0.189	9.4
SM6T27AY/CAY	0.2	1	23.1	25.7	27	28.4	1	37.5	16	0.569	48.3	83	0.240	9.6
SM6T30AY/CAY	0.2	1	25.6	28.5	30	31.5	1	41.5	14.5	0.690	53.5	75	0.293	9.7
SM6T33AY/CAY	0.2	1	28.2	31.4	33	34.7	1	45.7	13.1	0.840	59.0	68	0.357	9.8
SM6T36AY/CAY	0.2	1	30.8	34.2	36	37.8	1	49.9	12	1.01	64.3	62	0.427	9.9
SM6T39AY/CAY	0.2	1	33.3	37.1	39	41.0	1	53.9	11.1	1.16	69.7	57	0.504	10.0
SM6T42AY/CAY	0.2	1	36	40	42.1	44.2	1	58.1	10.3	1.35	76	52	0.611	10.0
SM6T47AY/CAY	0.2	1	40	44	46.7	49.0	1	64.5	9.7	1.59	84.0	48.0	0.728	10.1
SM6T56AY/CAY	0.2	1	47.6	53.2	56	58.8	1	76.6	7.8	2.28	100	40	1.030	10.0
SM6T68AY/CAY	0.2	1	58.1	64.6	68	71.4	1	92	6.5	3.17	121	33	1.503	10.4
SM6T75AY/CAY	0.2	1	64.1	71.3	75	78.8	1	103	5.8	4.17	134	30	1.84	10.5
SM6T82AY/CAY	0.2	1	70.0	77.8	81.9	86.0	1	113	5.5	4.91	146	27.0	2.22	10.5

1. To calculate  $V_{BR}$  versus  $T_j$ :  $V_{BR}$  at  $T_j = V_{BR}$  at  $25\text{ °C} \times (1 + \alpha T \times (T_j - 25))$
2. To calculate  $V_{CL}$  versus  $T_j$ :  $V_{CL}$  at  $T_j = V_{CL}$  at  $25\text{ °C} \times (1 + \alpha T \times (T_j - 25))$
3. To calculate  $V_{CL}$  max versus  $I_{PPappli}$ :  $V_{CLmax} = V_{BR}$  max +  $R_D \times I_{PPappli}$
4. Surge capability given for both directions for unidirectional and bidirectional devices

## 1.1 Characteristics (curves)

**Figure 4. Maximum peak power dissipation versus initial junction temperature**

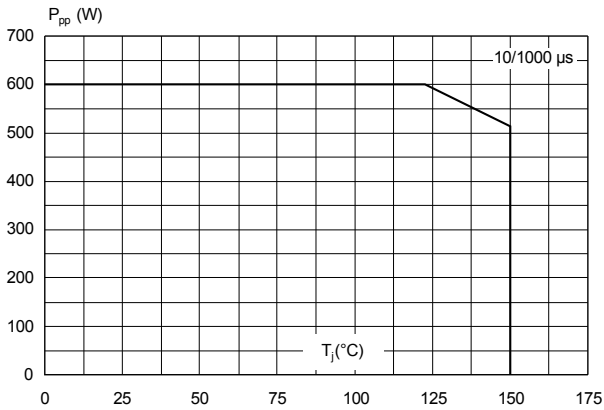

**Figure 5. Maximum peak pulse power versus exponential pulse duration**

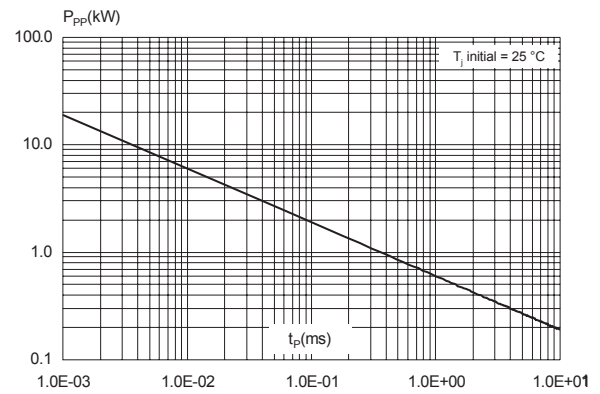

**Figure 6. Maximum peak pulse current versus clamping voltage**

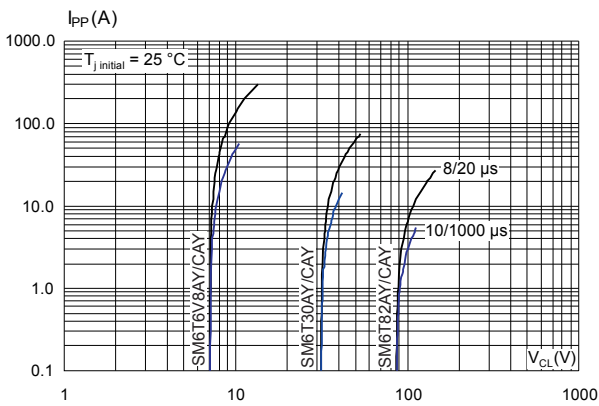

**Figure 7. Junction capacitance versus reverse applied voltage (unidirectional types)**

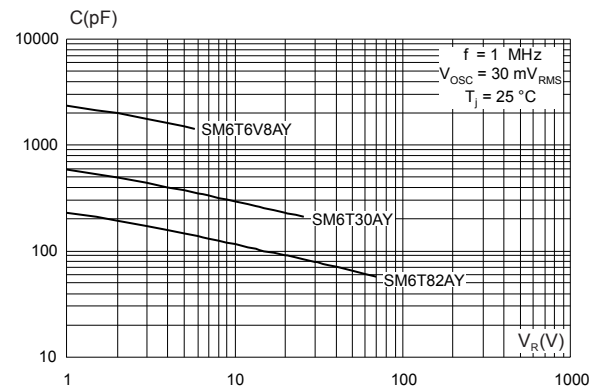

**Figure 8. Junction capacitance versus applied voltage (bidirectional type)**

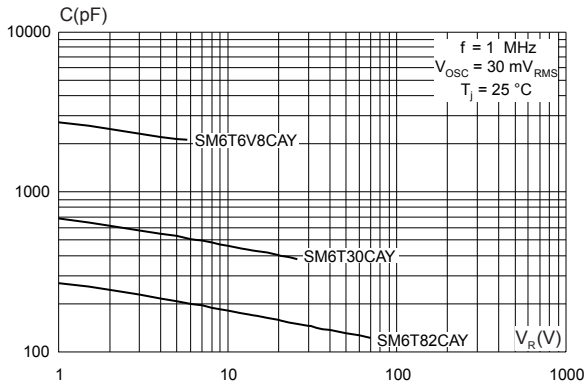

**Figure 9. Leakage current versus junction temperature**

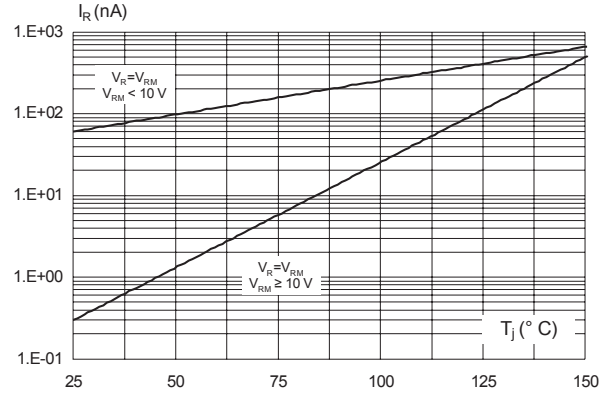

**Figure 10. Peak forward voltage drop versus peak forward current**

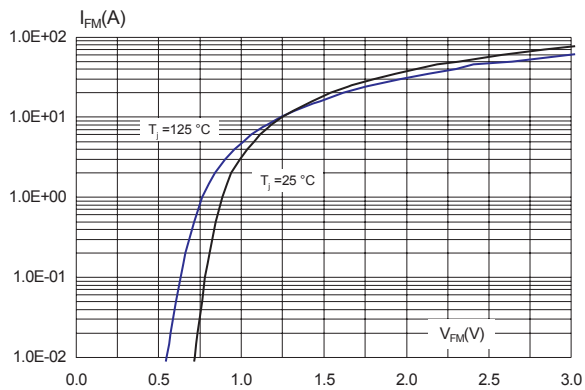

**Figure 11. Thermal impedance junction to ambient versus pulse duration**

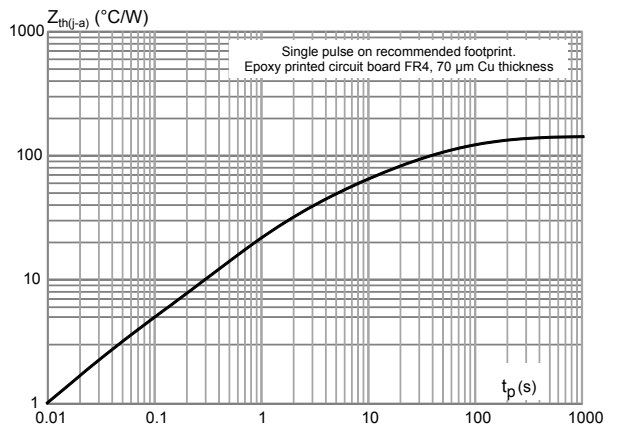

**Figure 12. Thermal resistance junction to ambient versus copper area under each lead (SMB)**

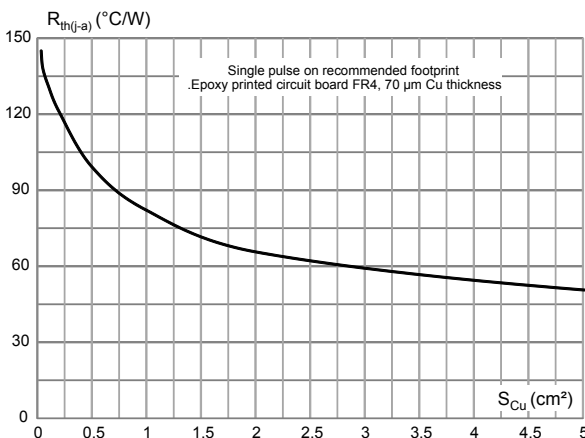

**Figure 13. ISO7637-2 pulse 1:  $V_s = -150 \text{ V}$  with 12 V battery**

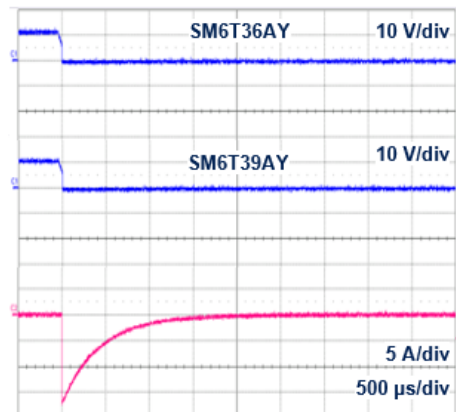

**Figure 14. ISO7637-2 pulse 2a:  $V_s = +112\text{ V}$  with 12 V battery**

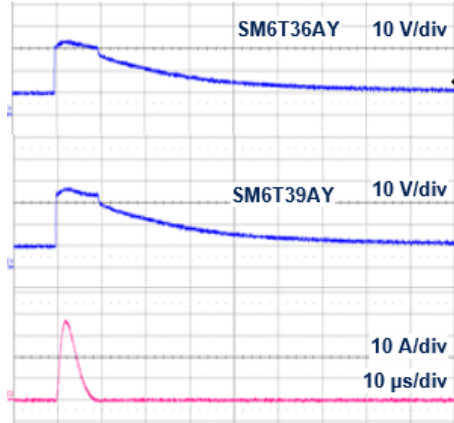

**Figure 15. ISO7637-2 pulse 3a:  $V_s = -220\text{ V}$  with 12 V battery**

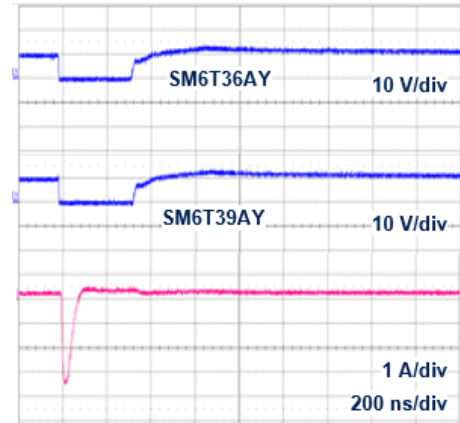

**Figure 16. ISO7637-2 pulse 3b:  $V_s = +150\text{ V}$  with 12 V battery**

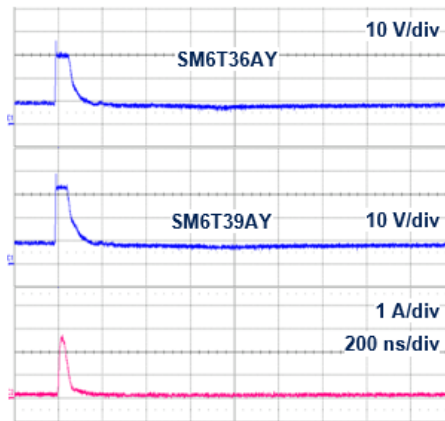

## 2 Package information

In order to meet environmental requirements, ST offers these devices in different grades of **ECOPACK** packages, depending on their level of environmental compliance. ECOPACK specifications, grade definitions and product status are available at: [www.st.com](http://www.st.com). ECOPACK is an ST trademark.

### 2.1 SMB package information

Figure 17. SMB package outline

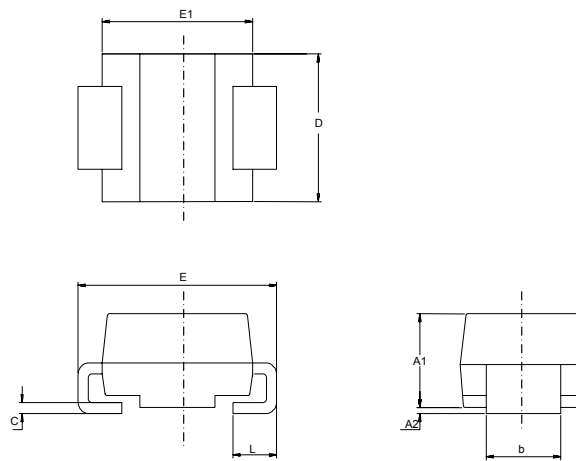

Table 3. SMB package mechanical data

Ref.	Dimensions			
	Millimeters		Inches <sup>(1)</sup>	
	Min.	Max.	Min.	Max.
A1	1.90	2.45	0.0748	0.0965
A2	0.05	0.20	0.0020	0.0079
b	1.95	2.20	0.0768	0.0867
c	0.15	0.40	0.0059	0.0157
D	3.30	3.95	0.1299	0.1556
E	5.10	5.60	0.2008	0.2205
E1	4.05	4.60	0.1594	0.1811
L	0.75	1.50	0.0295	0.0591

1. Values in inches are converted from mm

Figure 18. SMB recommended footprint

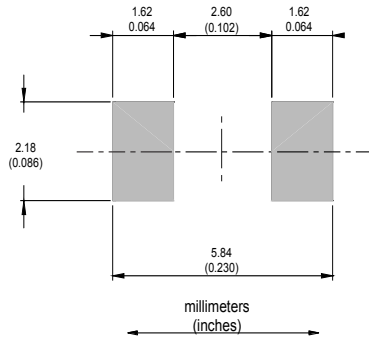

Figure 19. Marking layout

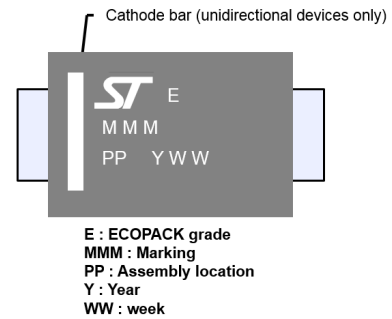
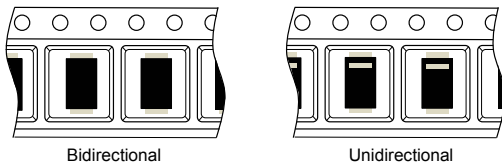

Figure 20. Package orientation in reel



Taped according to EIA-481  
Pocket dimensions are not on scale.  
Pocket shape may vary depending on package  
On bidirectional devices, marking and logo may not be always in the same direction.

Figure 21. Tape and reel orientation

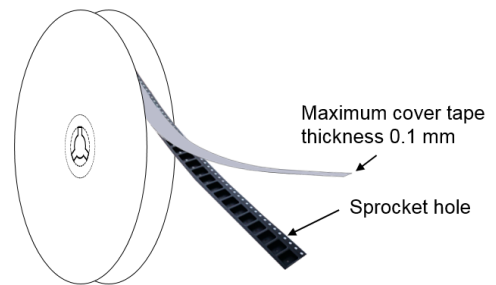

Figure 22. Reel dimensions (mm)

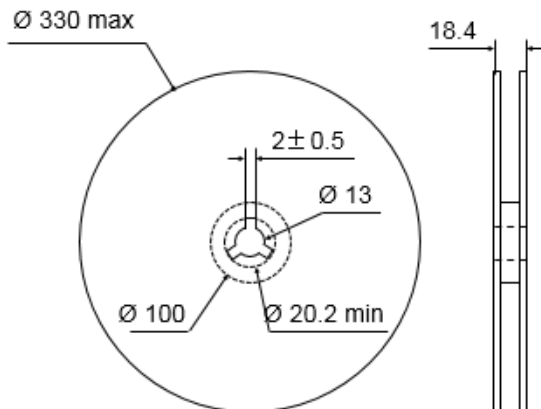

Figure 23. Inner box dimensions (mm)

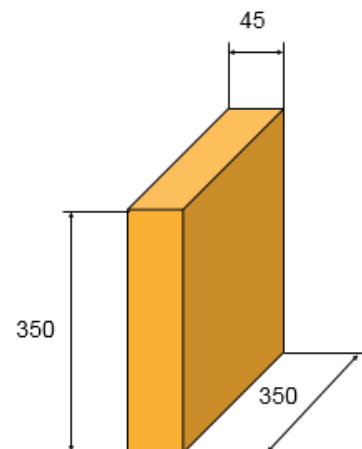
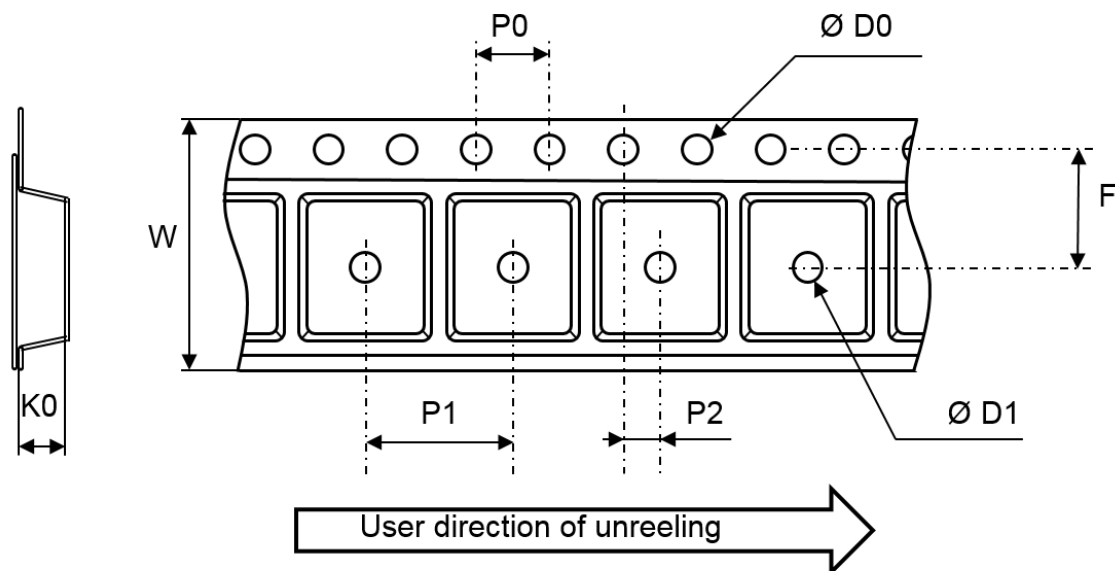



Figure 24. Tape and reel outline



Note: Pocket dimensions are not on scale  
Pocket shape may vary depending on package

Table 4. Tape and reel mechanical data

Ref.	Dimensions		
	Millimeters		
	Min.	Typ.	Max.
ØD0	1.5	1.55	1.6
ØD1	1.5		
F	5.4	5.5	5.6
K0	2.64	2.74	2.84
P0	3.9	4.0	4.1
P1	7.9	8.0	8.1
P2	1.9	2.0	2.1
W	11.7	12.0	12.3

## 2.2 Reflow profile

Figure 25. ST ECOPACK<sup>®</sup> recommended soldering reflow profile for PCB mounting

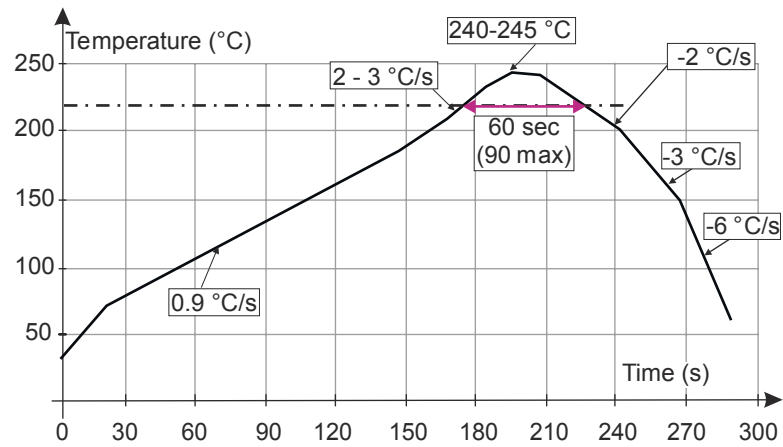

*Note:* Minimize air convection currents in the reflow oven to avoid component movement. Maximum soldering profile corresponds to the latest IPC/JEDEC J-STD-020.

### **3 Application and design guidelines**

---

More information is available in the application note AN2689 “Protection of automotive electronics from electrical hazards, guidelines for design and component selection”.

## 4 Ordering information

Figure 26. Ordering information scheme

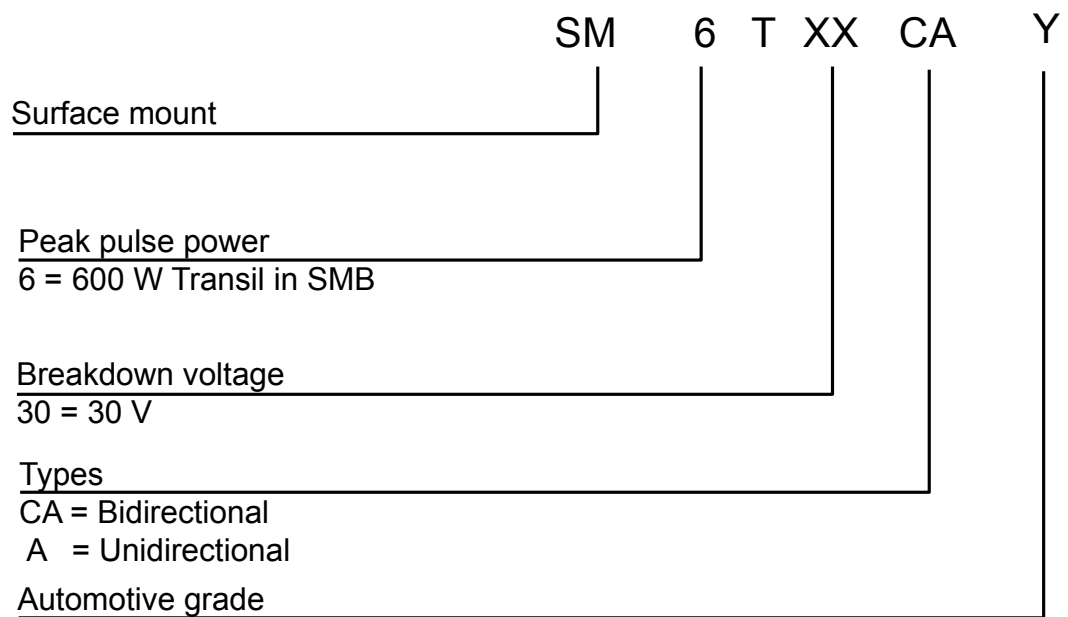

Table 5. Ordering information

Order code	Marking	Package	Weight	Base qty.	Delivery mode
SM6TxxxAY / CAY	See Table 6. Marking	SMB	0.11 g	2500	Tape and reel

**Table 6. Marking**

Order code	Marking	Order code	Marking
SM6T6V8AY	DEY	SM6T6V8CAY	LEY
SM6T7V5AY	DGY	SM6T7V5CAY	LGY
SM6T10AY	DPY	SM6T10CAY	LPY
SM6T12AY	DTY	SM6T12CAY	LTY
SM6T15AY	DXY	SM6T15CAY	LXY
SM6T16V5AY	DZY	SM6T16V5CAY	LZY
SM6T18AY	EEY	SM6T18CAY	MEY
SM6T22AY	EKY	SM6T22CAY	MKY
SM6T24AY	EMY	SM6T24CAY	MMY
SM6T27AY	EPY	SM6T27CAY	MPY
SM6T30AY	ERY	SM6T30CAY	MRY
SM6T33AY	ETY	SM6T33CAY	MTY
SM6T36AY	EVY	SM6T36CAY	MVY
SM6T39AY	EXY	SM6T39CAY	MXY
SM6T42AY	FBY	SM6T42CAY	NAY
SM6T47AY	FAY	SM6T47CAY	NBY
SM6T56AY	FLY	SM6T56CAY	NLY
SM6T68AY	FQY	SM6T68CAY	NQY
SM6T75AY	FSY	SM6T75CAY	NSY
SM6T82AY	FWY	SM6T82CAY	NWY

## Revision history

**Table 7. Document revision history**

Date	Version	Changes
15-Sep-2010	1	Initial release.
18-Oct-2011	2	Deleted old Table 2. Thermal parameter. Updated Table 2 and added order codes in Table 4. Updated Figure 5, Figure 10 and Figure 11. Updated Complies with the following standards on page 1.
27-Mar-2012	3	Added footnote on page 1.
26-Sep-2014	4	Updated Table 2 and Table 4. Reformatted to current standard.
19-Nov-2014	5	Updated Figure 7 and Figure 8.
05-Oct-2015	6	Updated Figure 17.
09-Jan-2018	7	Updated Table 2: "Electrical characteristics parameter values ( $T_{amb} = 25\text{ °C}$ , unless otherwise specified)".
16-Mar-2018	8	Updated revision numbering.
20-Mar-2018	9	Updated order code SM6T16V5AY/SM6T16V5CAY.
02-May-2019	10	Updated <a href="#">Section 1.1 Characteristics (curves)</a> and <a href="#">Table 6. Marking</a> . Added <a href="#">Section 2.2 Reflow profile</a> and <a href="#">Section 3 Application and design guidelines</a> .

**IMPORTANT NOTICE – PLEASE READ CAREFULLY**

STMicroelectronics NV and its subsidiaries (“ST”) reserve the right to make changes, corrections, enhancements, modifications, and improvements to ST products and/or to this document at any time without notice. Purchasers should obtain the latest relevant information on ST products before placing orders. ST products are sold pursuant to ST’s terms and conditions of sale in place at the time of order acknowledgement.

Purchasers are solely responsible for the choice, selection, and use of ST products and ST assumes no liability for application assistance or the design of Purchasers’ products.

No license, express or implied, to any intellectual property right is granted by ST herein.

Resale of ST products with provisions different from the information set forth herein shall void any warranty granted by ST for such product.

ST and the ST logo are trademarks of ST. For additional information about ST trademarks, please refer to [www.st.com/trademarks](http://www.st.com/trademarks). All other product or service names are the property of their respective owners.

Information in this document supersedes and replaces information previously supplied in any prior versions of this document.

© 2019 STMicroelectronics – All rights reserved

## Данный компонент на территории Российской Федерации

### Вы можете приобрести в компании MosChip.

Для оперативного оформления запроса Вам необходимо перейти по данной ссылке:

<http://moschip.ru/get-element>

Вы можете разместить у нас заказ для любого Вашего проекта, будь то серийное производство или разработка единичного прибора.

В нашем ассортименте представлены ведущие мировые производители активных и пассивных электронных компонентов.

Нашей специализацией является поставка электронной компонентной базы двойного назначения, продукции таких производителей как XILINX, Intel (ex.ALTERA), Vicor, Microchip, Texas Instruments, Analog Devices, Mini-Circuits, Amphenol, Glenair.

Сотрудничество с глобальными дистрибьюторами электронных компонентов, предоставляет возможность заказывать и получать с международных складов практически любой перечень компонентов в оптимальные для Вас сроки.

На всех этапах разработки и производства наши партнеры могут получить квалифицированную поддержку опытных инженеров.

Система менеджмента качества компании отвечает требованиям в соответствии с ГОСТ Р ИСО 9001, ГОСТ РВ 0015-002 и ЭС РД 009

### Офис по работе с юридическими лицами:

105318, г.Москва, ул.Щербаковская д.3, офис 1107, 1118, ДЦ «Щербаковский»

Телефон: +7 495 668-12-70 (многоканальный)

Факс: +7 495 668-12-70 (доб.304)

E-mail: [info@moschip.ru](mailto:info@moschip.ru)

Skype отдела продаж:

moschip.ru

moschip.ru\_4

moschip.ru\_6

moschip.ru\_9