

SPDT SWITCH GaAs MMIC

■ GENERAL DESCRIPTION

The NJG1801K75 is a SPDT switch IC suited for switching transmit/receive signals at 802.11 a/b/g/n/ac applications.

The NJG1801K75 features low insertion loss, high isolation, and high handling power.

This switch exhibits wide frequency coverage up to 6.0GHz. And the ultra small and ultra thin package of DFN6-75 is adopted.

■ PACKAGE OUTLINE

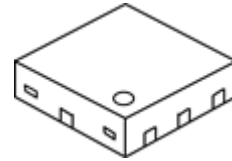

NJG1801K75

■ APPLICATION

802.11 a/b/g/n/ac networks applications

Transmit / receive switching, path switching applications

■ FEATURES

- Control voltage $V_{CTL(H)}=3.0V$ typ.
 $V_{CTL(L)}=0V$ typ.
- Low insertion loss 0.35dB typ. @f=2.4 to 2.5GHz
0.45dB typ. @f=4.9 to 5.9GHz
- High isolation 28dB typ. @f=2.4 to 2.5GHz
30dB typ. @f=4.9 to 5.9GHz
- P-1dB $P_{-1dB}=31$ dBm typ. @f=2.5GHz
 $P_{-1dB}=31$ dBm typ. @f=5.9GHz
- Ultra small & ultra thin package DFN6-75 (Package Size: 1.0x1.0x0.375mm typ.)
- RoHS compliant and Halogen Free, MSL1

■ PIN CONFIGURATION

(Top view)

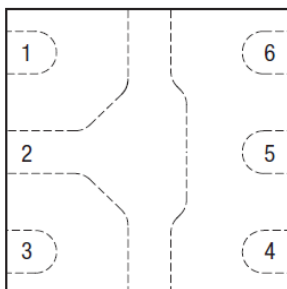

Pin connection

1. P1
2. GND
3. P2
4. VCTL2
5. PC
6. VCTL1

■ TRUTH TABLE

“H”= $V_{CTL(H)}$, “L”= $V_{CTL(L)}$

ON PATH	VCTL1	VCTL2
PC-P1	L	H
PC-P2	H	L

NOTE: Please note that any data or drawing in this catalog is subject to change.

■ ABSOLUTE MAXIMUM RATINGS

$T_a=+25^{\circ}\text{C}$, $Z_S=Z_I=50\ \Omega$

PARAMETER	SYMBOL	CONDITIONS	RATINGS	UNITS
RF Input Power	P_{IN}	$V_{CTL(L)}=0\text{V}$, $V_{CTL(H)}=3.0\text{V}$, ON State Port	+31	dBm
Control Voltage	V_{CTL}		6.0	V
Power Dissipation	P_D	4-layer FR4 PCB without through-hole (76.2x114.3mm), $T_i=150^{\circ}\text{C}$	430	mW
Operating Temperature	T_{opr}		-40 to +105	$^{\circ}\text{C}$
Storage Temperature	T_{stg}		-55 to +150	$^{\circ}\text{C}$

■ ELECTRICAL CHARACTERISTICS1 (DC CHARACTERISTICS)

(General conditions: $V_{CTL(H)}=3.0\text{V}$, $V_{CTL(L)}=0\text{V}$, $T_a=+25^{\circ}\text{C}$, with application circuit)

PARAMETERS	SYMBOL	CONDITIONS	MIN	TYP	MAX	UNITS
Control Voltage (HIGH)	$V_{CTL(H)}$		1.8	3.0	5.0	V
Control Voltage (LOW)	$V_{CTL(L)}$		-0.2	-	0.2	V
Control Current	I_{CTL}		-	5	10	μA

■ ELECTRICAL CHARACTERISTICS2 (RF CHARACTERISTICS)

(General conditions: $V_{CTL(H)}=3.0V$, $V_{CTL(L)}=0V$, $T_a=+25^{\circ}C$, $Z_S=Z_L=50\ \Omega$, with application circuit)

PARAMETERS	SYMBOL	CONDITIONS	MIN	TYP	MAX	UNITS
Insertion loss1	LOSS1	f=2.4 to 2.5GHz	-	0.35	0.55	dB
Insertion loss2	LOSS2	f=4.9 to 5.9GHz	-	0.45	0.70	dB
Isolation1	ISL1	f=2.4 to 2.5GHz	25	28	-	dB
Isolation2	ISL2	f=4.9 to 5.9GHz	25	30	-	dB
Return loss1	RL1	f=2.4 to 2.5GHz	18	28	-	dB
Return loss2	RL2	f=4.9 to 5.9GHz	15	20	-	dB
Input power at 1dB compression point1	P_{-1dB1}	f=2.4 to 2.5GHz	29	31	-	dBm
Input power at 1dB compression point2	P_{-1dB2}	f=4.9 to 5.9GHz	28	31	-	dBm
Switching time	T_{SW}	50% VCTL to 10%/90% RF	-	100	300	ns

■ TERMINAL INFORMATION

No.	SYMBOL	DESCRIPTION
1	P1	RF terminal. An external DC blocking capacitor is required.
2	GND	Ground terminal. Please connect this terminal with ground plane as close as possible for excellent RF performance.
3	P2	RF terminal. An external DC blocking capacitor is required.
4	VCTL2	Control voltage input terminal.
5	PC	Common RF terminal. An external DC blocking capacitor is required.
6	VCTL1	Control voltage input terminal.

ELECTRICAL CHARACTERISTICS

Loss, ISL vs Frequency

(PC-P1 ON, $V_{CTL(H)}=3.0V$, $V_{CTL(L)}=0V$)

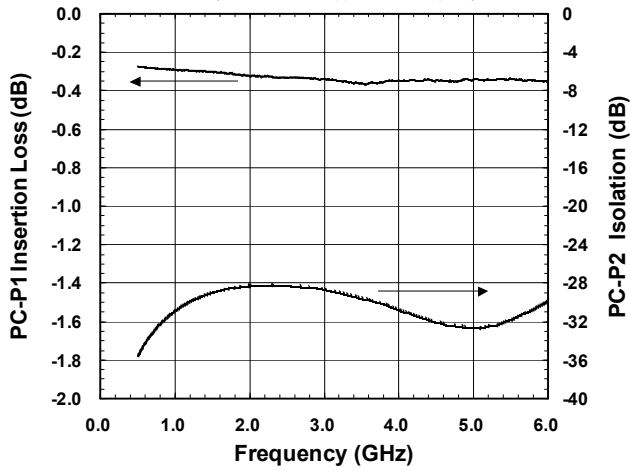

Loss, ISL vs Frequency

(PC-P2 ON, $V_{CTL(H)}=3.0V$, $V_{CTL(L)}=0V$)

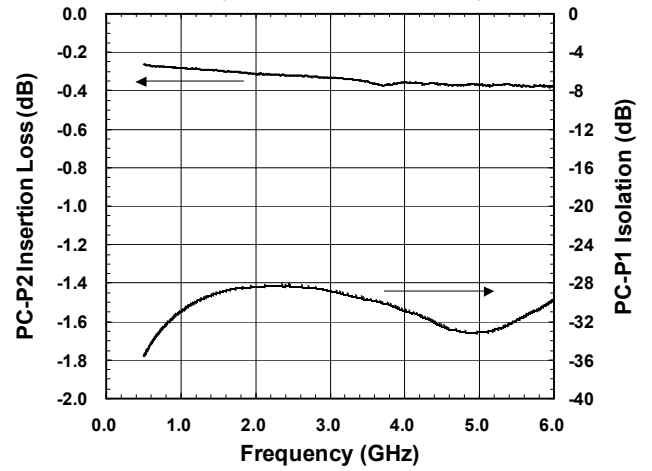

Return Loss vs Frequency

(PC-P1 ON, $V_{CTL(H)}=3.0V$, $V_{CTL(L)}=0V$)

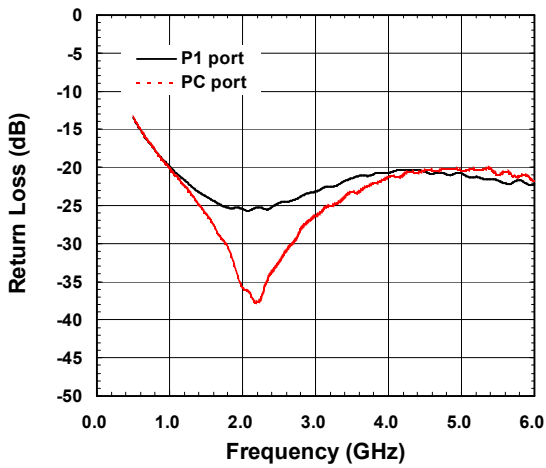

Return Loss vs Frequency

(PC-P2 ON, $V_{CTL(H)}=3.0V$, $V_{CTL(L)}=0V$)

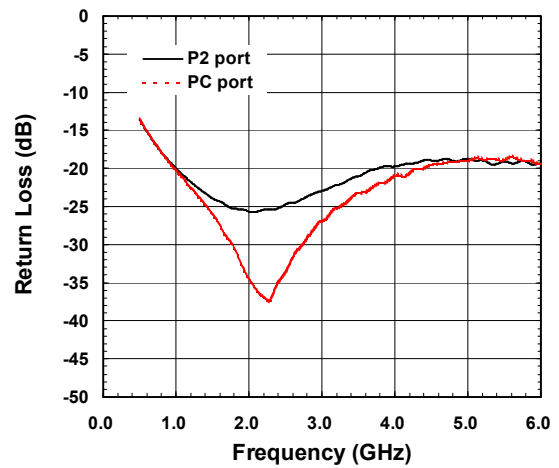

Switching Time

(PC-P1 Path, $V_{CTL(H)}=3.0V$, $V_{CTL(L)}=0V$)

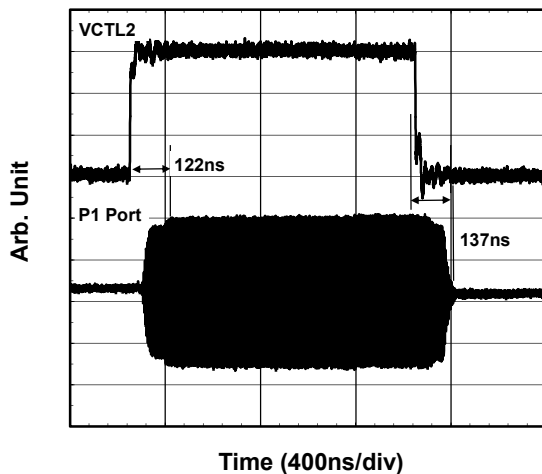

■ ELECTRICAL CHARACTERISTICS

Output Power, I_{CTL} vs Input Power

(PC-P1 ON, $V_{CTL(L)}=0V$, $f=2.5GHz$)

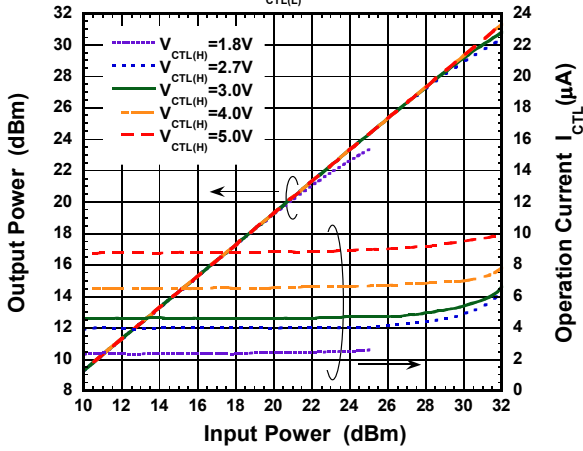

Loss, ISL vs Input Power

(PC-P1 ON, $V_{CTL(L)}=0V$, $f=2.5GHz$)

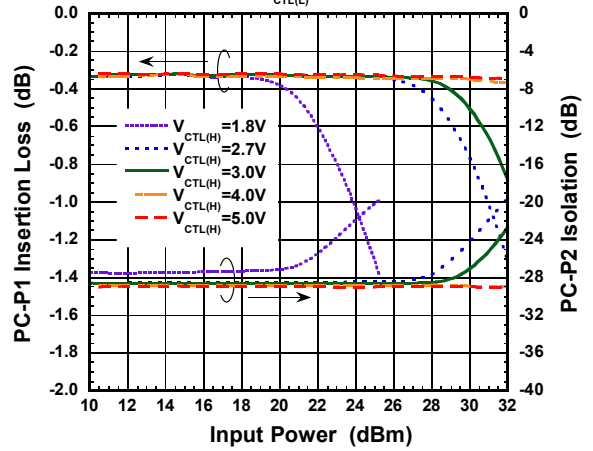

Output Power, I_{CTL} vs Input Power

(PC-P1 ON, $V_{CTL(L)}=0V$, $f=5.9GHz$)

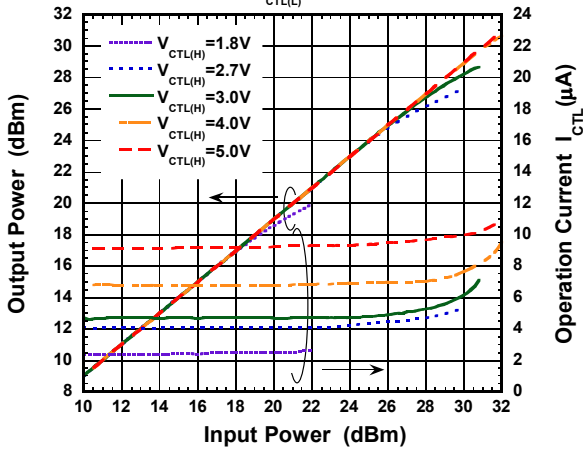

Loss, ISL vs Input Power

(PC-P1 ON, $V_{CTL(L)}=0V$, $f=5.9GHz$)

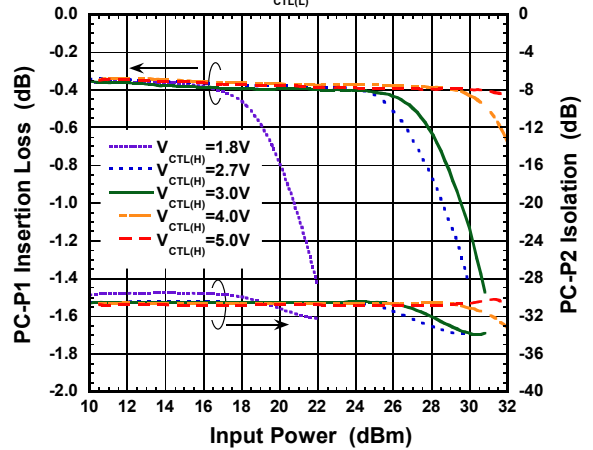

Output Power, IM3 vs Input Power

(PC-P1 ON, $V_{CTL(H)}=3.0V$, $V_{CTL(L)}=0V$, $f=2.5GHz+2.501GHz$)

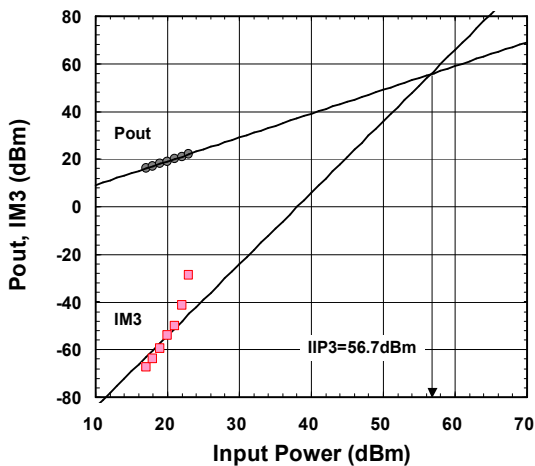

IIP3 vs Input Power

(PC-P1 ON, $V_{CTL(L)}=0V$, $f=2.5GHz+2.501GHz$)

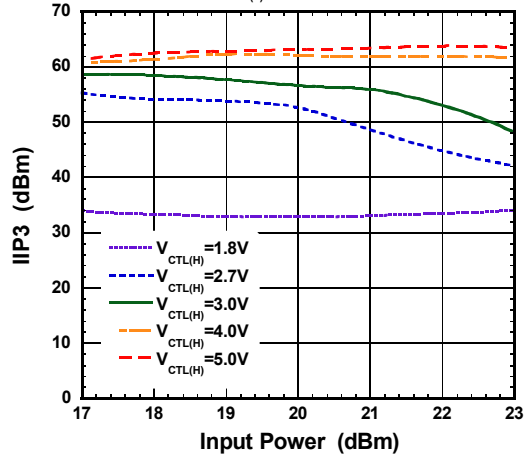

■ ELECTRICAL CHARACTERISTICS

EVM vs Input Power

(PC-P1 ON, $V_{CTL(L)}=0V$, $f=2.5GHz$, OFDM 64QAM)

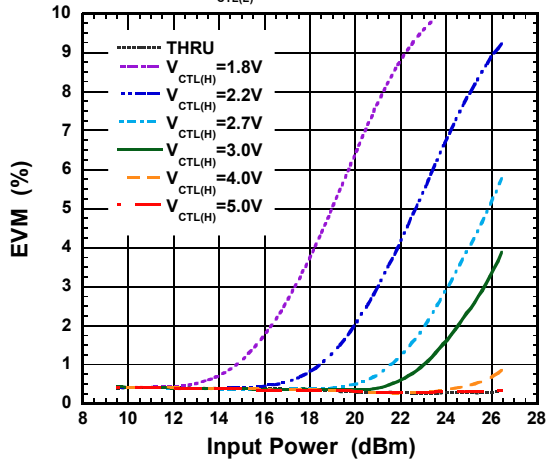

EVM vs Input Power

(PC-P1 ON, $V_{CTL(L)}=0V$, $f=5.9GHz$, OFDM 64QAM)

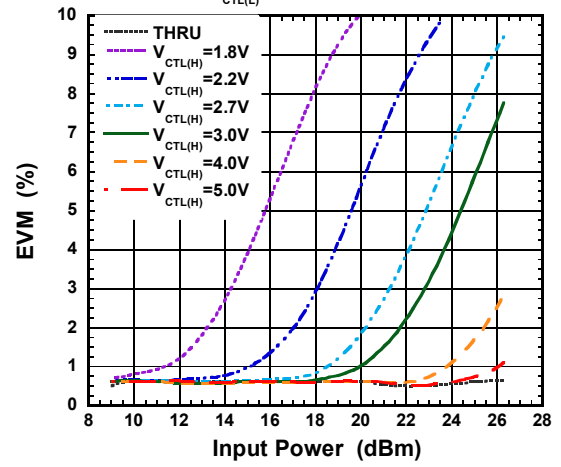

■ ELECTRICAL CHARACTERISTICS

Loss, ISL vs Temperature

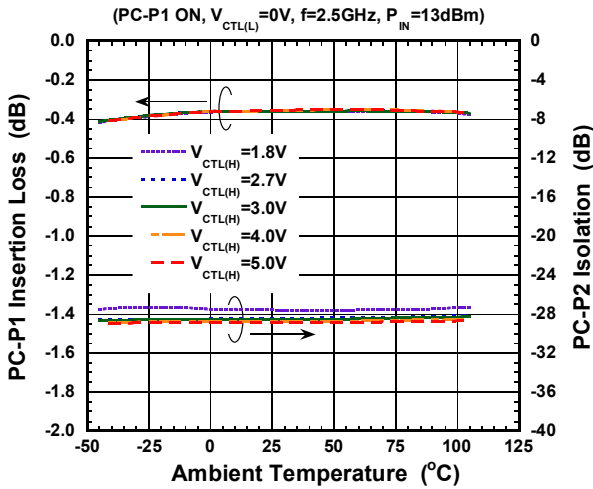

Loss, ISL vs Temperature

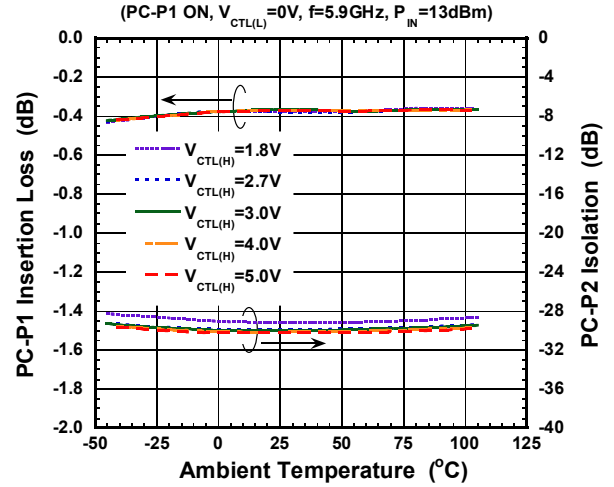

Return Loss vs Temperature

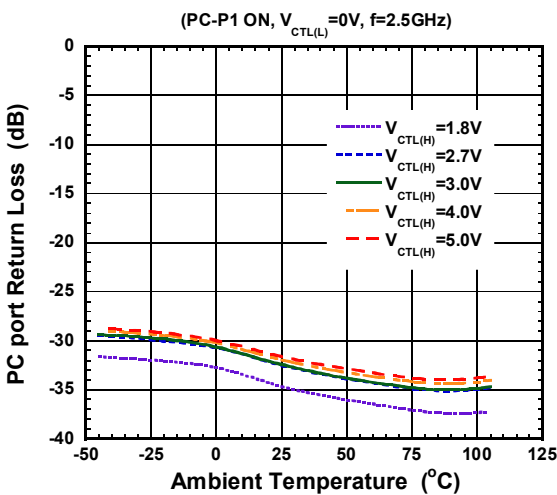

Return Loss vs Temperature

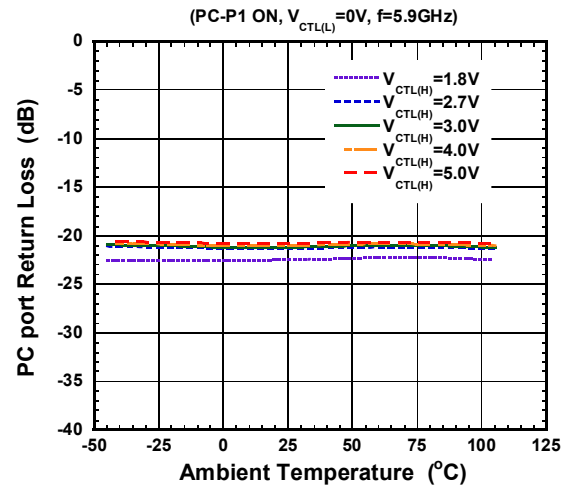

P_{-1dB} vs Temperature

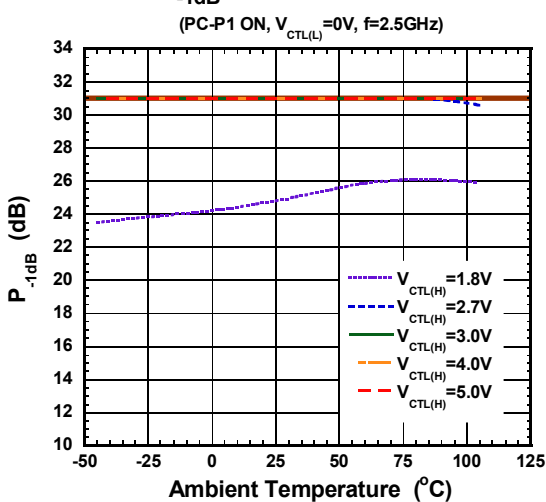

Switching Time(rise) vs Temperature

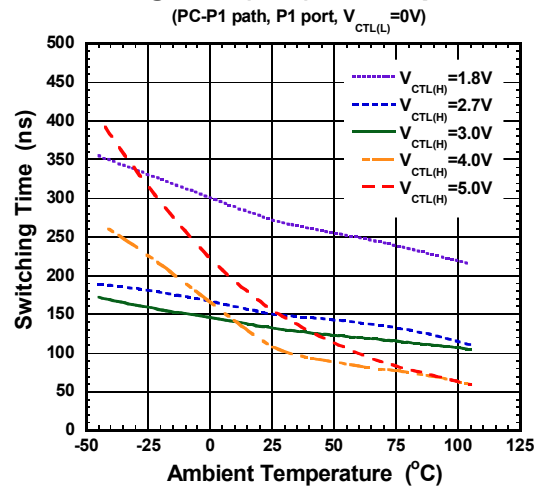

APPLICATION CIRCUIT

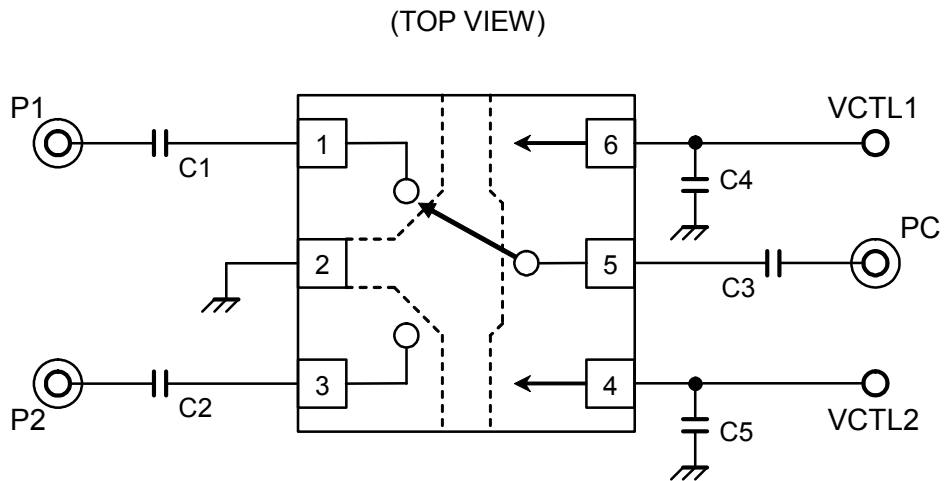

RECOMMENDED PCB DESIGN

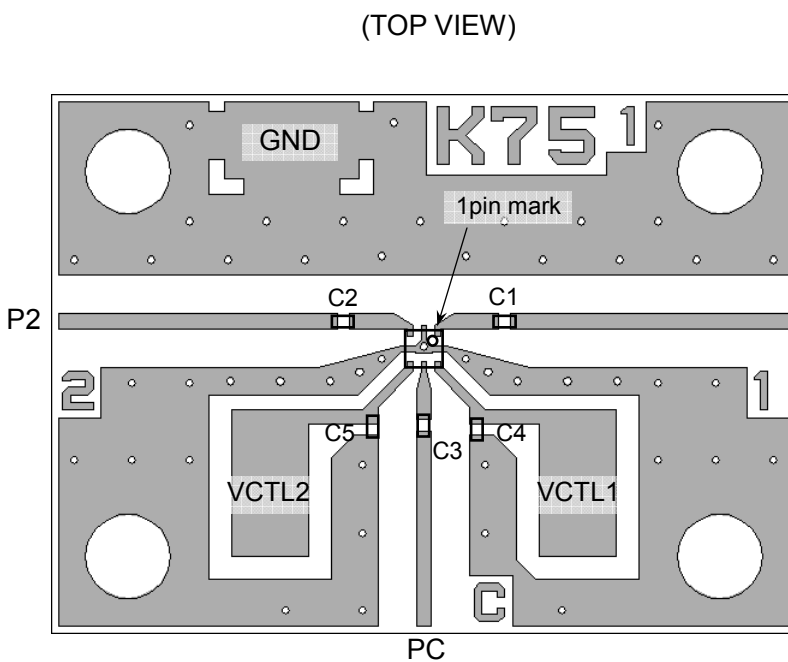

PCB: FR-4, $t=0.2\text{mm}$
 Capacitor Size: 0603 (0.6 x 0.3 mm)
 Strip Line Width: 0.4mm
 PCB Size: 19.4 x 14.0mm
 Through Hole Diameter: 0.2mm

Loss of PCB, capacitor and connectors

Frequency (GHz)	Loss (dB)
2.4	0.33
2.5	0.34
4.9	0.55
5.9	0.65

PARTS LIST

No.	Value	Notes
C1 to C3	27pF	Murata MFG (GRM03 series)
C4 to C5	10pF	

PCB LAYOUT GUIDELINE

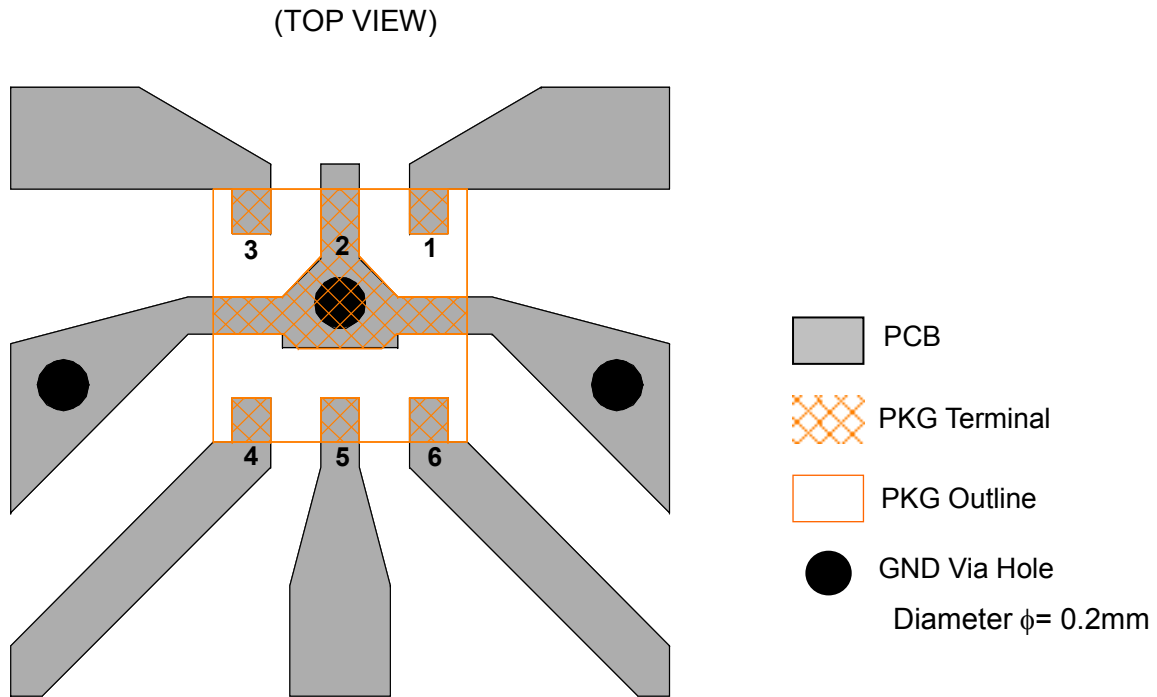

PRECAUTIONS

- [1] The DC blocking capacitors should be placed at RF terminals. Please choose appropriate capacitance value at the application frequency.
- [2] For good RF performance, exposed pad should be connected to PCB ground plane as close as possible.

RECOMMENDED FOOTPRINT PATTERN (6pin DFN Package 1.0x1.0mm) <Reference>

Package: 1.0mm x 1.0mm

Pin pitch: 0.35mm

 : Land

 : Mask (Open area) *Metal mask thickness: 100μm

 : Resist (Open area)

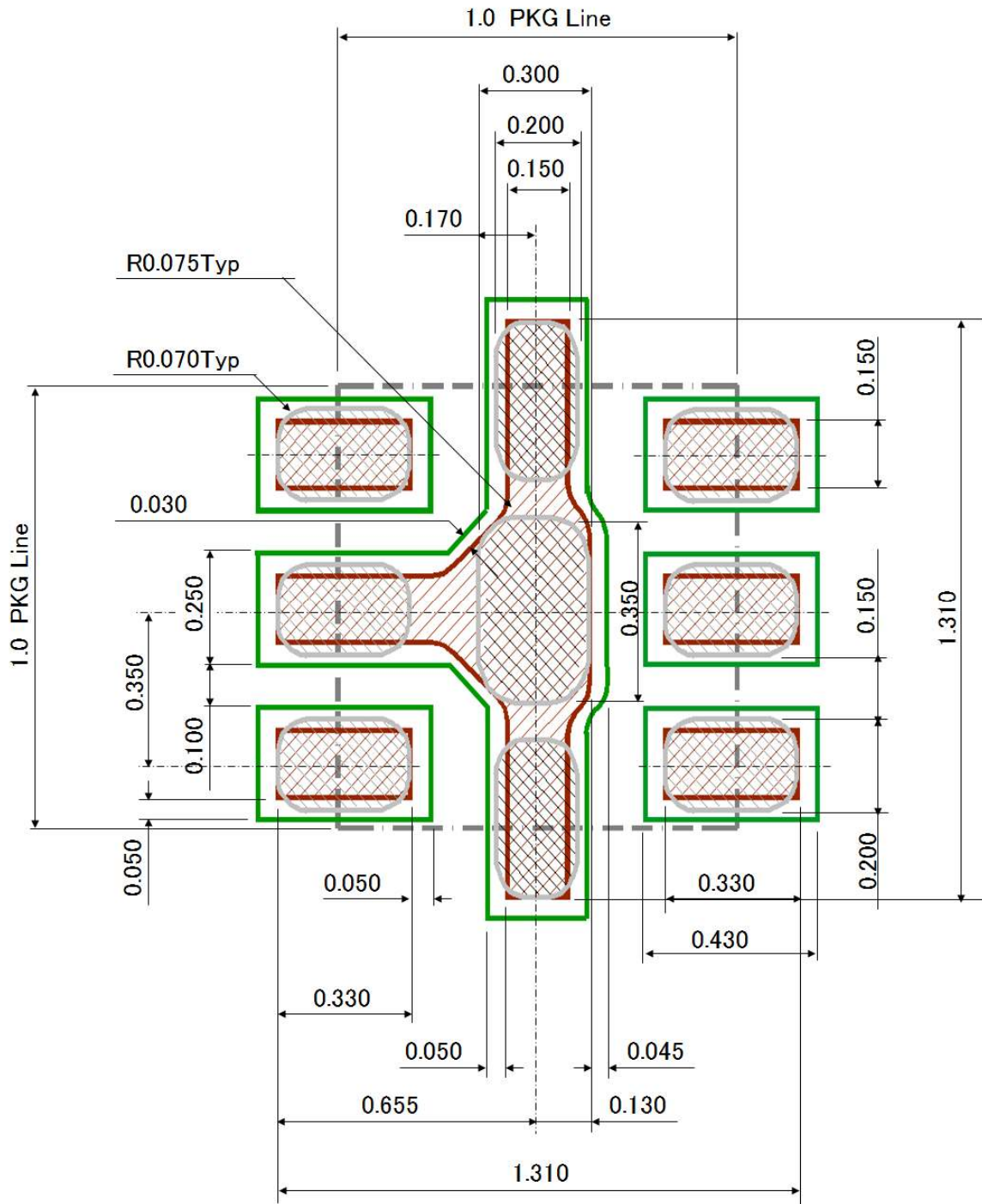

PACKAGE OUTLINE (DFN6-75)

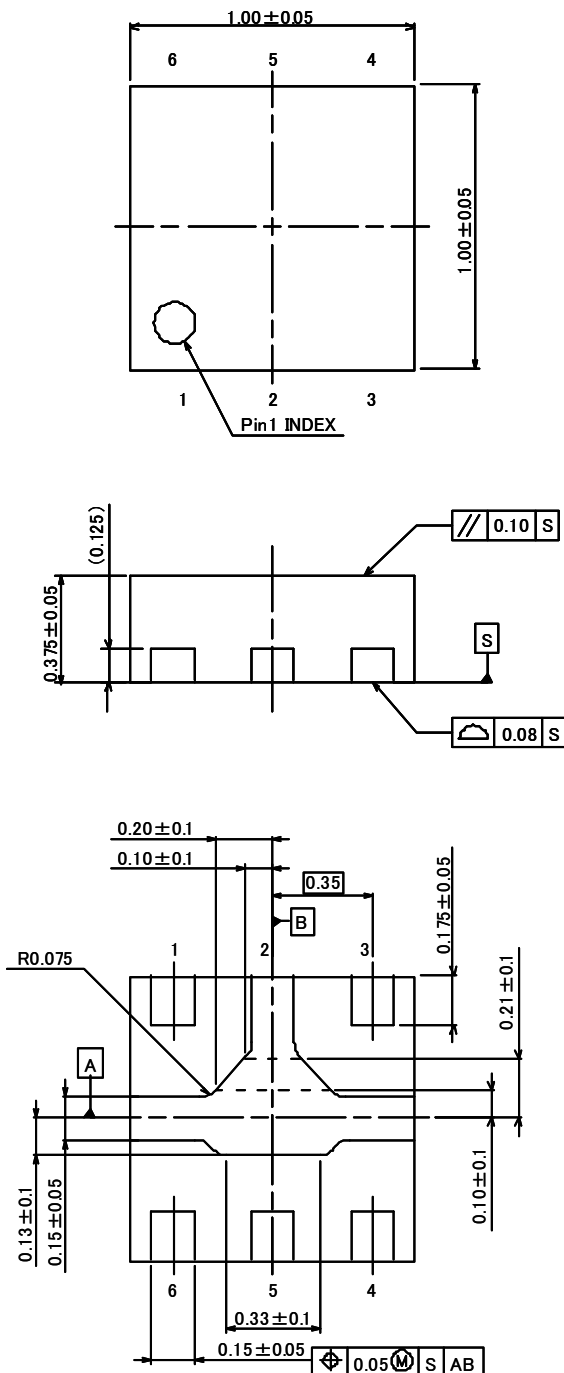

Unit	: mm
Board	: Cu
Terminal Treat	: Ni/Pd/Au
Molding Material	: Epoxy resin
Weight	: 1.2mg

Cautions on using this product

- This product contains Gallium-Arsenide (GaAs) which is a harmful material.
- Do NOT eat or put into mouth.
- Do NOT dispose in fire or break up this product.
- Do NOT chemically make gas or powder with this product.
- To waste this product, please obey the relating law of your country.

[CAUTION]

The specifications on this databook are only given for information, without any guarantee as regards either mistakes or omissions. The application circuits in this databook are described only to show representative usages of the product and not intended for the guarantee or permission of any right including the industrial rights.

This product may be damaged with electric static discharge (ESD) or spike voltage. Please handle with care to avoid these damages.

Mouser Electronics

Authorized Distributor

Click to View Pricing, Inventory, Delivery & Lifecycle Information:

[NJR:](#)

[NJG1801K75](#) [NJG1801K75-TE1](#)

Данный компонент на территории Российской Федерации

Вы можете приобрести в компании MosChip.

Для оперативного оформления запроса Вам необходимо перейти по данной ссылке:

<http://moschip.ru/get-element>

Вы можете разместить у нас заказ для любого Вашего проекта, будь то серийное производство или разработка единичного прибора.

В нашем ассортименте представлены ведущие мировые производители активных и пассивных электронных компонентов.

Нашей специализацией является поставка электронной компонентной базы двойного назначения, продукции таких производителей как XILINX, Intel (ex.ALTERA), Vicor, Microchip, Texas Instruments, Analog Devices, Mini-Circuits, Amphenol, Glenair.

Сотрудничество с глобальными дистрибьюторами электронных компонентов, предоставляет возможность заказывать и получать с международных складов практически любой перечень компонентов в оптимальные для Вас сроки.

На всех этапах разработки и производства наши партнеры могут получить квалифицированную поддержку опытных инженеров.

Система менеджмента качества компании отвечает требованиям в соответствии с ГОСТ Р ИСО 9001, ГОСТ РВ 0015-002 и ЭС РД 009

Офис по работе с юридическими лицами:

105318, г.Москва, ул.Щербаковская д.3, офис 1107, 1118, ДЦ «Щербаковский»

Телефон: +7 495 668-12-70 (многоканальный)

Факс: +7 495 668-12-70 (доб.304)

E-mail: info@moschip.ru

Skype отдела продаж:

moschip.ru

moschip.ru_4

moschip.ru_6

moschip.ru_9