

## A Series of Three- to Five-digit Digital Display Units with a Character Height of 14 mm. Models available with either red or green displays.

- Red or green displays with a character height of 14 mm are available for a variety of applications and locations.
- Miniature design with a 50-mm depth.
- Incorporating a connector, thus saving wiring effort.
- Connecting to OMRON's PLCs via dedicated PLC cables (sold separately).
- Units and minus symbols are displayed (three- and four-digit model only).
- Incorporating a zero suppression function.
- The power supply can freely change between 12 and 24 VDC.
- CE Marking. UL certification approval.



## Model Number Structure

### Model Number Legend



4. Display Color

| Code | Color |
|------|-------|
| R    | Red   |
| G    | Green |

5. Display Contents

| Code | Display Contents          |
|------|---------------------------|
| F    | Numerals and minus symbol |
| T    | Numerals and units        |
| None | Numerals only             |

- Note:**
1. The input type for the five-digit model is dynamic only.
  2. Dynamic input is available with the four-digit model as well as the five-digit model.
  3. The minus symbol and units are available with three and four-digit models only.
  4. Three-digit models with numerals only are not available.

## Construction and Nomenclature

### Nomenclature



# Ordering Information









## List of Models

| No. of digits | Appearance  | Display color             | Input method       | Logic      | Display contents          | Model      |
|---------------|---|---------------------------|--------------------|------------|---------------------------|------------|
| 3             |    | Red                       | Static             | Positive   | Numerals and minus symbol | M7F-3P1RF  |
|               |   |                           |                    |            | Numerals and units        | M7F-3P1RT* |
|               |   |                           |                    | Negative   | Numerals and minus symbol | M7F-3N1RF  |
|               |   |                           | Numerals and units | M7F-3N1RT* |                           |            |
|               |   | Green                     | Static             | Positive   | Numerals and minus symbol | M7F-3P1GF  |
|               |   |                           |                    |            | Numerals and units        | M7F-3P1GT* |
| Negative      | Numerals and minus symbol   |                           |                    | M7F-3N1GF  |                           |            |
|               | Numerals and units  | M7F-3N1GT*                |                    |            |                           |            |
| 4             |    | Red                       | Static             | Positive   | Numerals only             | M7F-4P1R   |
|               |   |                           |                    |            | Numerals and minus symbol | M7F-4P1RF  |
|               |   |                           |                    |            | Numerals and units        | M7F-4P1RT* |
|               |   |                           |                    | Negative   | Numerals only             | M7F-4N1R   |
|               |   |                           |                    |            | Numerals and minus symbol | M7F-4N1RF  |
|               |   |                           |                    |            | Numerals and units        | M7F-4N1RT* |
|               |   |                           | Dynamic            | Positive   | Numerals only             | M7F-4D1R   |
|               |   |                           |                    |            | Numerals and minus symbol | M7F-4D1RF  |
|               |   |                           |                    |            | Numerals and units        | M7F-4D1RT* |
|               |   | Green                     | Static             | Positive   | Numerals only             | M7F-4P1G   |
|               |   |                           |                    |            | Numerals and minus symbol | M7F-4P1GF  |
|               |   |                           |                    |            | Numerals and units        | M7F-4P1GT* |
|               |   |                           |                    | Negative   | Numerals only             | M7F-4N1G   |
|               |   |                           |                    |            | Numerals and minus symbol | M7F-4N1GF  |
|               |   |                           |                    |            | Numerals and units        | M7F-4N1GT* |
| Dynamic       | Positive  | Numerals only             | M7F-4D1G           |            |                           |            |
|               |   | Numerals and minus symbol | M7F-4D1GF          |            |                           |            |
|               |   | Numerals and units        | M7F-4D1GT*         |            |                           |            |
| 5             |  | Red                       | Dynamic            | Positive   | Numerals only             | M7F-5D1R   |
|               |   | Green                     | Dynamic            | Positive   | Numerals only             | M7F-5D1G   |

## Accessories (Order Separately)

### Unit Plate

- Choose the required unit plate from the following tables in order to attach it to the Unit Display Unit.
- Unit Plates are replaceable.
- Ten Unit Plates are sold as a set. (The number per set is the same for all models.)
- The characters are white.

| Display contents  | Single item (sheet only):<br>1 Set of 10 sheets |
|---|---|
|    | M7F-1   |
|    | M7F-RPM-1                                       |
|    | M7F-PER-1                                       |
|    | M7F-KG-1  |
|    | M7F-MM-1  |
|    | M7F-M-1   |
|   | M7F-DOC-1                                       |
|  | M7F-PCS-1                                       |

## Connectable PLCs

| M7F model |             | PLC's output method |            |                |
|-----------|-------------|---------------------|------------|----------------|
| Input     | Logic input | Static output       |            | Dynamic output |
|           |             | PNP output          | NPN output |                |
| Static    | Positive    | ○                   | ×          | ×              |
|           | Negative    | ×                   | ○          | ×              |
| Dynamic   |             | ×                   | ×          | ○              |

○: Connectable (See note 1.)

×: Not connectable

**Note:** 1. External resistance not required

2. Refer to *External Connections* on page 9 for details.

## Compatibility with OMRON PLCs (Examples)

| PLC Output Unit   | M7F model |
|---|-----------|
| CS1W-OD211<br>C200H-OD215/218/219<br>C500-OD213<br>CQM1-OD213 | M7F-□N□□  |
| CS1W-OD212<br>C500-OD212                                      | M7F-□P□□  |
| C200H-OD215   | M7F-□D□□  |

**Cables**

Use the following cables and connectors to connect the M7F to the PLC or other devices.

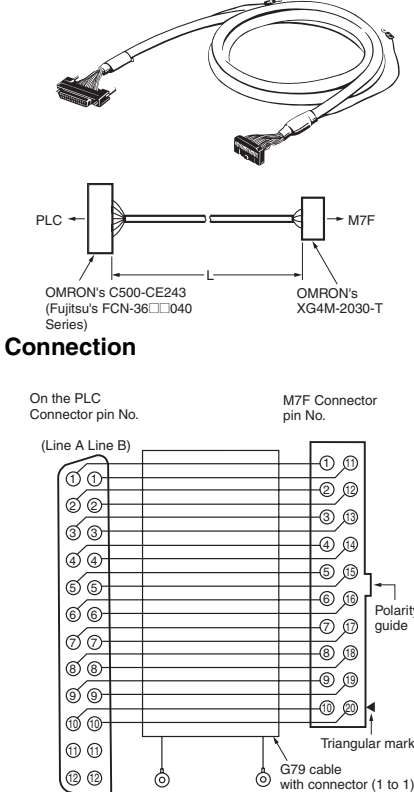
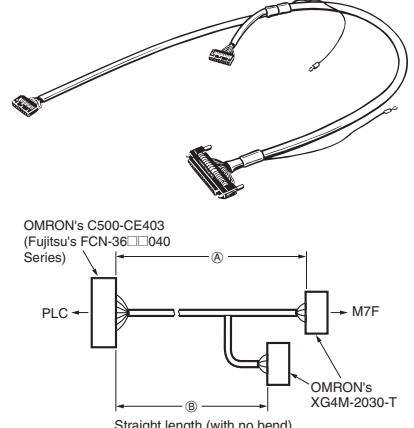
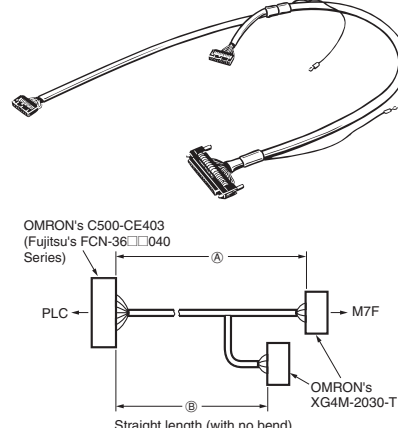
| Model name  | Application   | Appearance   | Ordering Information  |              |       |            |           |          |           |          |           |              |           |          |               |          |          |               |          |          |               |          |          |               |
|---|---|--|---|--------------|-------|------------|-----------|----------|-----------|----------|-----------|--------------|-----------|----------|---------------|----------|----------|---------------|----------|----------|---------------|----------|----------|---------------|
| <p>G79-□C<br/>Cable with<br/>Connectors<br/>(1 to 1)</p>    | <p>Connects the M7F and a single device.<br/>Applicable PLC Output Units: C500-OD415CN, C200H-OD215, and C200H-MD215<br/>(Output Units incorporating a 24-pin connector each)</p>                                     |  <p><b>Note:</b> The connector pin numbers are shown from the crimped sides of the connectors.</p> | <table border="1"> <thead> <tr> <th>L Dimensions</th> <th>Model</th> </tr> </thead> <tbody> <tr> <td>1,000 mm</td> <td>G79-100C</td> </tr> <tr> <td>1,500 mm</td> <td>G79-150C</td> </tr> <tr> <td>2,000 mm</td> <td>G79-200C</td> </tr> <tr> <td>3,000 mm</td> <td>G79-300C</td> </tr> <tr> <td>5,000 mm</td> <td>G79-500C</td> </tr> </tbody> </table>  | L Dimensions | Model | 1,000 mm   | G79-100C  | 1,500 mm | G79-150C  | 2,000 mm | G79-200C  | 3,000 mm     | G79-300C  | 5,000 mm | G79-500C      |          |          |               |          |          |               |          |          |               |
| L Dimensions  | Model   |  |   |              |       |            |           |          |           |          |           |              |           |          |               |          |          |               |          |          |               |          |          |               |
| 1,000 mm  | G79-100C  |  |   |              |       |            |           |          |           |          |           |              |           |          |               |          |          |               |          |          |               |          |          |               |
| 1,500 mm  | G79-150C  |  |   |              |       |            |           |          |           |          |           |              |           |          |               |          |          |               |          |          |               |          |          |               |
| 2,000 mm  | G79-200C  |  |   |              |       |            |           |          |           |          |           |              |           |          |               |          |          |               |          |          |               |          |          |               |
| 3,000 mm  | G79-300C  |  |   |              |       |            |           |          |           |          |           |              |           |          |               |          |          |               |          |          |               |          |          |               |
| 5,000 mm  | G79-500C  |  |   |              |       |            |           |          |           |          |           |              |           |          |               |          |          |               |          |          |               |          |          |               |
| <p>G79-O□C-□<br/>Cable with<br/>Connectors<br/>(1 to 2)</p> | <p>Connects the M7F and two devices.<br/>Suitable Output Units: C500-OD213, C200H-OD218, C200H-OD219, CQM1-OD213, CS1W-MD261, CJ1W-OD231, and CJ1W-OD261<br/>(Output Units incorporating a 40-pin connector each)</p> |   | <table border="1"> <thead> <tr> <th colspan="2">L Dimensions</th> <th>For output</th> </tr> <tr> <th>A</th> <th>B</th> <th>Model</th> </tr> </thead> <tbody> <tr> <td>1,000 mm</td> <td>750 mm</td> <td>G79-O100C-75</td> </tr> <tr> <td>1,500 mm</td> <td>1,250 mm</td> <td>G79-O150C-125</td> </tr> <tr> <td>2,000 mm</td> <td>1,750 mm</td> <td>G79-O200C-175</td> </tr> <tr> <td>3,000 mm</td> <td>2,750 mm</td> <td>G79-O300C-275</td> </tr> <tr> <td>5,000 mm</td> <td>4,750 mm</td> <td>G79-O500C-475</td> </tr> </tbody> </table> | L Dimensions |       | For output | A         | B        | Model     | 1,000 mm | 750 mm    | G79-O100C-75 | 1,500 mm  | 1,250 mm | G79-O150C-125 | 2,000 mm | 1,750 mm | G79-O200C-175 | 3,000 mm | 2,750 mm | G79-O300C-275 | 5,000 mm | 4,750 mm | G79-O500C-475 |
| L Dimensions  |   | For output   |   |              |       |            |           |          |           |          |           |              |           |          |               |          |          |               |          |          |               |          |          |               |
| A   | B   | Model  |   |              |       |            |           |          |           |          |           |              |           |          |               |          |          |               |          |          |               |          |          |               |
| 1,000 mm  | 750 mm  | G79-O100C-75   |   |              |       |            |           |          |           |          |           |              |           |          |               |          |          |               |          |          |               |          |          |               |
| 1,500 mm  | 1,250 mm  | G79-O150C-125  |   |              |       |            |           |          |           |          |           |              |           |          |               |          |          |               |          |          |               |          |          |               |
| 2,000 mm  | 1,750 mm  | G79-O200C-175  |   |              |       |            |           |          |           |          |           |              |           |          |               |          |          |               |          |          |               |          |          |               |
| 3,000 mm  | 2,750 mm  | G79-O300C-275  |   |              |       |            |           |          |           |          |           |              |           |          |               |          |          |               |          |          |               |          |          |               |
| 5,000 mm  | 4,750 mm  | G79-O500C-475  |   |              |       |            |           |          |           |          |           |              |           |          |               |          |          |               |          |          |               |          |          |               |
| <p>G79-Y□C<br/>Cable with<br/>Crimp-style<br/>Terminals</p> | <p>Ideal for the connection of the M7F to devices incorporating screw terminals.<br/>Suitable Output Units: CS1W-OD211, CS1W-OD212, C200H-OD212, and C500-OD412</p>   |   | <table border="1"> <thead> <tr> <th>L Dimensions</th> <th>Model</th> </tr> </thead> <tbody> <tr> <td>1,000 mm</td> <td>G79-Y100C</td> </tr> <tr> <td>1,500 mm</td> <td>G79-Y150C</td> </tr> <tr> <td>2,000 mm</td> <td>G79-Y200C</td> </tr> <tr> <td>3,000 mm</td> <td>G79-Y300C</td> </tr> <tr> <td>5,000 mm</td> <td>G79-Y500C</td> </tr> </tbody> </table>   | L Dimensions | Model | 1,000 mm   | G79-Y100C | 1,500 mm | G79-Y150C | 2,000 mm | G79-Y200C | 3,000 mm     | G79-Y300C | 5,000 mm | G79-Y500C     |          |          |               |          |          |               |          |          |               |
| L Dimensions  | Model   |  |   |              |       |            |           |          |           |          |           |              |           |          |               |          |          |               |          |          |               |          |          |               |
| 1,000 mm  | G79-Y100C   |  |   |              |       |            |           |          |           |          |           |              |           |          |               |          |          |               |          |          |               |          |          |               |
| 1,500 mm  | G79-Y150C   |  |   |              |       |            |           |          |           |          |           |              |           |          |               |          |          |               |          |          |               |          |          |               |
| 2,000 mm  | G79-Y200C   |  |   |              |       |            |           |          |           |          |           |              |           |          |               |          |          |               |          |          |               |          |          |               |
| 3,000 mm  | G79-Y300C   |  |   |              |       |            |           |          |           |          |           |              |           |          |               |          |          |               |          |          |               |          |          |               |
| 5,000 mm  | G79-Y500C   |  |   |              |       |            |           |          |           |          |           |              |           |          |               |          |          |               |          |          |               |          |          |               |

# Specifications

## ■ Applicable EN Standards

| Standards                       |
|---------------------------------|
| EN61326<br>EN60529<br>UL61010-1 |

## ■ Ratings

|  |                      |  |  |
|--|----------------------|--|--|
| <b>Rated power supply</b>                  |                      | 12 to 24 VDC   |  |
| <b>Allowable voltage fluctuation range</b> |                      | 90% to 110% of rated voltage   |  |
| <b>Current consumption</b>                 |                      | 200 mA max. (at 12 VDC)<br>100 mA max. (at 24 VDC)   |  |
| <b>Input level</b>                         | <b>Static input</b>  | <b>Positive</b>  | High: 9.6 V to power supply voltage<br>Low: 0 to 3 V |
|  |                      | <b>Negative</b>  | High: 4 V to power supply voltage<br>Low: 0 to 1.5 V |
|  | <b>Dynamic input</b> | <b>Positive (See note.)</b>  | High: 4 V to power supply voltage<br>Low: 0 to 1.5 V |
| <b>Ambient temperature</b>                 |                      | Operating: -10 to 55°C (with no icing or condensation)<br>Storage: -25 to 65°C (with no icing or condensation) |  |
| <b>Ambient humidity</b>                    |                      | Operating: 35% to 85% (with no icing or condensation)  |  |

**Note:** Use an NPN open collector for the output of the connection device. The data signal, however, is positive logic and the strobe signal is negative logic.

## ■ Characteristics

|                                   |  |
|-----------------------------------|--|
| <b>Insulation resistance</b>      | 100 MΩ min. (at 500 VDC) between each terminal and mounting panel  |
| <b>Dielectric strength</b>        | 1,000 VAC, 50/60 Hz for 1 min between each terminal and mounting panel   |
| <b>Noise immunity (See note.)</b> | Power terminal: ±500 V (normal mode)<br>±1,500 V (common mode)<br>I/O cable: ±800 V (when the specified cable is used) |
| <b>Vibration resistance</b>       | Destruction: 10 to 55 Hz, 1.5-mm double amplitude<br>10 sweeps of 5 min each in X, Y, and Z directions                 |
| <b>Shock resistance</b>           | Malfunction: 300 m/s <sup>2</sup><br>3 times each in 6 directions on X, Y, and Z axes                                  |
| <b>Degree of protection</b>       | IEC IP40 (front panel only)  |

**Note:** Impulse conditions:  
 Rise time: 1 ns +10% max.  
 Pulse width: 100 ns, 1 μs  
 Frequency: 100 Hz  
 Polarity: Positive or negative  
 Cable: OMRON's G79-100C

# Operation

## Input Codes

### Numeric Display

#### Positive Logic Static Input (M7F-□P□□□)

|                 | Input signal          |    |    |    |                       |    |    |    |                       |    |    |    |                       |    |    |    | Display condition     |                       |                       |                       |
|-----------------|-----------------------|----|----|----|-----------------------|----|----|----|-----------------------|----|----|----|-----------------------|----|----|----|-----------------------|-----------------------|-----------------------|-----------------------|
|                 | 10 <sup>3</sup> digit |    |    |    | 10 <sup>2</sup> digit |    |    |    | 10 <sup>1</sup> digit |    |    |    | 10 <sup>0</sup> digit |    |    |    |                       |                       |                       |                       |
| Terminal no.    | ⑱                     | ⑰  | ⑯  | ⑮  | ⑭                     | ⑬  | ⑫  | ⑪  | ⑧                     | ⑦  | ⑥  | ⑤  | ④                     | ③  | ②  | ①  | 10 <sup>3</sup> digit | 10 <sup>2</sup> digit | 10 <sup>1</sup> digit | 10 <sup>0</sup> digit |
| Terminal symbol | D4                    | C4 | B4 | A4 | D3                    | C3 | B3 | A3 | D2                    | C2 | B2 | A2 | D1                    | C1 | B1 | A1 |                       |                       |                       |                       |
| Input signals   | L                     | L  | L  | L  | L                     | L  | L  | L  | L                     | L  | L  | L  | L                     | L  | L  | L  | 0                     | 0                     | 0                     | 0                     |
|                 | L                     | L  | L  | H  | L                     | L  | L  | H  | L                     | L  | L  | H  | L                     | L  | L  | H  | 1                     | 1                     | 1                     | 1                     |
|                 | L                     | L  | H  | L  | L                     | L  | H  | L  | L                     | L  | H  | L  | L                     | L  | H  | L  | 2                     | 2                     | 2                     | 2                     |
|                 | L                     | L  | H  | H  | L                     | L  | H  | H  | L                     | L  | H  | H  | L                     | L  | H  | H  | 3                     | 3                     | 3                     | 3                     |
|                 | L                     | H  | L  | L  | L                     | H  | L  | L  | L                     | H  | L  | L  | L                     | H  | L  | L  | 4                     | 4                     | 4                     | 4                     |
|                 | L                     | H  | L  | H  | L                     | L  | H  | L  | H                     | L  | H  | L  | H                     | L  | H  | L  | 5                     | 5                     | 5                     | 5                     |
|                 | L                     | H  | H  | L  | L                     | H  | H  | L  | L                     | H  | H  | L  | L                     | H  | H  | L  | 6                     | 6                     | 6                     | 6                     |
|                 | L                     | H  | H  | H  | L                     | H  | H  | H  | L                     | H  | H  | H  | L                     | H  | H  | H  | 7                     | 7                     | 7                     | 7                     |
|                 | H                     | L  | L  | L  | H                     | L  | L  | L  | H                     | L  | L  | L  | H                     | L  | L  | L  | 8                     | 8                     | 8                     | 8                     |
|                 | H                     | L  | L  | H  | H                     | L  | L  | H  | H                     | L  | L  | H  | H                     | L  | L  | H  | 9                     | 9                     | 9                     | 9                     |
|                 | H                     | L  | H  | L  | H                     | L  | H  | L  | H                     | L  | H  | L  | H                     | L  | H  | L  | A                     | A                     | A                     | A                     |
|                 | H                     | L  | H  | H  | H                     | L  | H  | H  | H                     | L  | H  | H  | H                     | L  | H  | H  | b                     | b                     | b                     | b                     |
|                 | H                     | H  | L  | L  | H                     | H  | L  | L  | H                     | H  | L  | L  | H                     | H  | L  | L  | c                     | c                     | c                     | c                     |
|                 | H                     | H  | L  | H  | H                     | H  | L  | H  | H                     | H  | L  | H  | H                     | H  | L  | H  | d                     | d                     | d                     | d                     |
|                 | H                     | H  | H  | L  | H                     | H  | H  | L  | H                     | H  | H  | L  | H                     | H  | H  | L  | E                     | E                     | E                     | E                     |
|                 | H                     | H  | H  | H  | H                     | H  | H  | H  | H                     | H  | H  | H  | H                     | H  | H  | H  | F                     | F                     | F                     | F                     |

#### Negative Logic Static Input (M7F-□N□□□)

|                 | Input signal          |    |    |    |                       |    |    |    |                       |    |    |    |                       |    |    |    | Display condition     |                       |                       |                       |
|-----------------|-----------------------|----|----|----|-----------------------|----|----|----|-----------------------|----|----|----|-----------------------|----|----|----|-----------------------|-----------------------|-----------------------|-----------------------|
|                 | 10 <sup>3</sup> digit |    |    |    | 10 <sup>2</sup> digit |    |    |    | 10 <sup>1</sup> digit |    |    |    | 10 <sup>0</sup> digit |    |    |    |                       |                       |                       |                       |
| Terminal no.    | ⑱                     | ⑰  | ⑯  | ⑮  | ⑭                     | ⑬  | ⑫  | ⑪  | ⑧                     | ⑦  | ⑥  | ⑤  | ④                     | ③  | ②  | ①  | 10 <sup>3</sup> digit | 10 <sup>2</sup> digit | 10 <sup>1</sup> digit | 10 <sup>0</sup> digit |
| Terminal symbol | D4                    | C4 | B4 | A4 | D3                    | C3 | B3 | A3 | D2                    | C2 | B2 | A2 | D1                    | C1 | B1 | A1 |                       |                       |                       |                       |
| Input signals   | H                     | H  | H  | H  | H                     | H  | H  | H  | H                     | H  | H  | H  | H                     | H  | H  | H  | 0                     | 0                     | 0                     | 0                     |
|                 | H                     | H  | H  | L  | H                     | H  | H  | L  | H                     | H  | H  | L  | H                     | H  | H  | L  | 1                     | 1                     | 1                     | 1                     |
|                 | H                     | H  | L  | H  | H                     | H  | L  | H  | H                     | H  | L  | H  | H                     | H  | L  | H  | 2                     | 2                     | 2                     | 2                     |
|                 | H                     | H  | L  | L  | H                     | H  | L  | L  | H                     | H  | L  | L  | H                     | H  | L  | L  | 3                     | 3                     | 3                     | 3                     |
|                 | H                     | L  | H  | H  | H                     | L  | H  | H  | H                     | L  | H  | H  | H                     | L  | H  | H  | 4                     | 4                     | 4                     | 4                     |
|                 | H                     | L  | H  | L  | H                     | L  | H  | L  | H                     | L  | H  | L  | H                     | L  | H  | L  | 5                     | 5                     | 5                     | 5                     |
|                 | H                     | L  | L  | H  | H                     | L  | L  | H  | H                     | L  | L  | H  | H                     | L  | L  | H  | 6                     | 6                     | 6                     | 6                     |
|                 | H                     | L  | L  | L  | H                     | L  | L  | L  | H                     | L  | L  | L  | H                     | L  | L  | L  | 7                     | 7                     | 7                     | 7                     |
|                 | L                     | H  | H  | H  | L                     | H  | H  | H  | L                     | H  | H  | H  | L                     | H  | H  | H  | 8                     | 8                     | 8                     | 8                     |
|                 | L                     | H  | H  | L  | L                     | H  | H  | L  | L                     | H  | H  | L  | L                     | H  | H  | L  | 9                     | 9                     | 9                     | 9                     |
|                 | L                     | H  | L  | H  | L                     | H  | L  | H  | L                     | H  | L  | H  | L                     | H  | L  | H  | A                     | A                     | A                     | A                     |
|                 | L                     | H  | L  | L  | L                     | H  | L  | L  | L                     | H  | L  | L  | L                     | H  | L  | L  | b                     | b                     | b                     | b                     |
|                 | L                     | L  | H  | H  | L                     | L  | H  | H  | L                     | L  | H  | H  | L                     | L  | H  | H  | c                     | c                     | c                     | c                     |
|                 | L                     | L  | H  | L  | L                     | L  | H  | L  | L                     | L  | H  | L  | L                     | L  | H  | L  | d                     | d                     | d                     | d                     |
|                 | L                     | L  | L  | H  | L                     | L  | L  | H  | L                     | L  | L  | H  | L                     | L  | L  | H  | E                     | E                     | E                     | E                     |
|                 | L                     | L  | L  | L  | L                     | L  | L  | L  | L                     | L  | L  | L  | L                     | L  | L  | L  | F                     | F                     | F                     | F                     |

### Dynamic Input (M7F-□D□□□)

| Terminal no.    | Input signal |   |   |   |    |    |    |    |    | Display condition     |                       |                       |                       |                       |
|-----------------|--------------|---|---|---|----|----|----|----|----|-----------------------|-----------------------|-----------------------|-----------------------|-----------------------|
|                 | ④            | ③ | ② | ① | ⑪  | ⑫  | ⑬  | ⑭  | ⑮  | 10 <sup>4</sup> digit | 10 <sup>3</sup> digit | 10 <sup>2</sup> digit | 10 <sup>1</sup> digit | 10 <sup>0</sup> digit |
| Terminal symbol | D            | C | B | A | S0 | S1 | S2 | S3 | S4 |                       |                       |                       |                       |                       |
| Input signals   | L            | L | L | L | L  | H  | H  | H  | H  | *                     | *                     | *                     | *                     | 0                     |
|                 | L            | L | L | H | H  | L  | H  | H  | H  | *                     | *                     | *                     | 1                     | *                     |
|                 | L            | L | H | L | H  | H  | L  | H  | H  | *                     | *                     | 2                     | *                     | *                     |
|                 | L            | L | H | H | H  | H  | H  | L  | H  | *                     | 3                     | *                     | *                     | *                     |
|                 | L            | H | L | L | H  | H  | H  | H  | L  | 4                     | *                     | *                     | *                     | *                     |
|                 | L            | H | L | H | L  | H  | H  | H  | H  | *                     | *                     | *                     | *                     | 5                     |
|                 | L            | H | H | L | H  | L  | H  | H  | H  | *                     | *                     | *                     | 6                     | *                     |
|                 | L            | H | H | H | H  | H  | L  | H  | H  | *                     | *                     | 7                     | *                     | *                     |
|                 | H            | L | L | L | H  | H  | H  | L  | H  | *                     | 8                     | *                     | *                     | *                     |
|                 | H            | L | L | H | H  | H  | H  | H  | L  | 9                     | *                     | *                     | *                     | *                     |
|                 | H            | L | H | L | L  | H  | H  | H  | H  | *                     | *                     | *                     | *                     | a                     |
|                 | H            | H | L | L | H  | H  | L  | H  | H  | *                     | *                     | €                     | *                     | *                     |
|                 | H            | H | L | H | H  | H  | H  | L  | H  | *                     | d                     | *                     | *                     | *                     |
|                 | H            | H | H | L | H  | H  | H  | H  | L  | £                     | *                     | *                     | *                     | *                     |
| H               | H            | H | H | L | H  | H  | H  | H  | *  | *                     | *                     | *                     | F                     |                       |

\* The data of S0 to S4 when S0 to S4 are high before S0 to S4 become low will be held and displayed. Refer to *Operation Timing (Input Signal Timing)* on page 12 and *Operation Chart* on page 12 for details.

### Unit Display

The displays are lit when voltage is supplied to the power supply terminals (positive and negative terminals).

### Minus Symbol and Decimal Point

The DIP switch is used for minus symbol and decimal point settings as shown in the following table.

| Display contents                                | Model     | DIP switch function |
|---|-----------|---------------------|
| Three digits<br>Numerals<br>and minus<br>symbol | M7F-3□□□F |                     |
| Three digits<br>Numerals<br>and unit            | M7F-3□□□T |                     |
| Four digits<br>Numerals<br>only                 | M7F-4□□□□ |                     |
| Four digits<br>Numerals<br>and minus<br>symbol  | M7F-4□□□F |                     |
| Four digits<br>Numerals<br>and unit             | M7F-4□□□T |                     |
| Five digits<br>Numerals<br>only                 | M7F-5□□□□ |                     |

**Note:** 1. The minus symbol and decimal point are always lit when the corresponding pins of the DIP switch are set to ON.  
2. "NC" means "not connected".

### Zero Suppression Function

The Unit has a function for blanking (i.e., turning OFF the display) to not display 0 when the leftmost digits are zero. When DP (decimal point) has been displayed using the DIP switch, the digits to the left of the decimal point display digit will be blank as shown in the following figure.

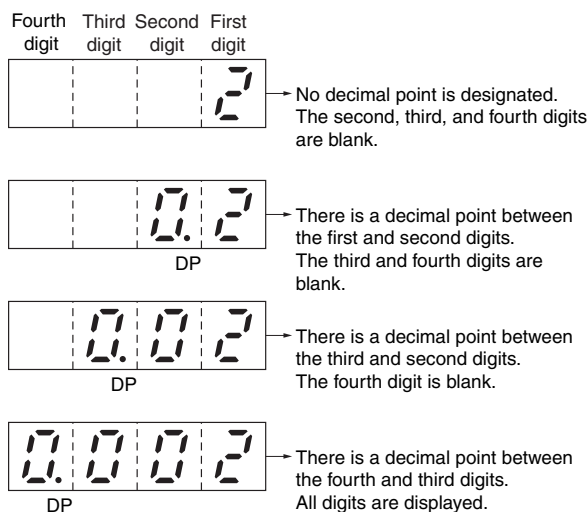

**Note:** The zero suppression function is normally operating.

# Terminal Arrangement/Functions

## Terminal Arrangement

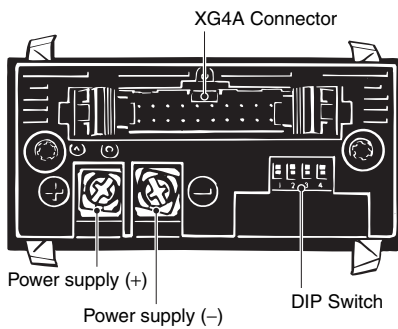

### XG4A Connector

#### Static Input Model

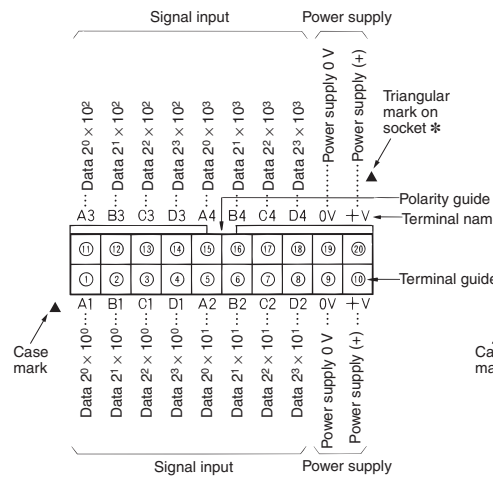

#### Dynamic Input Model

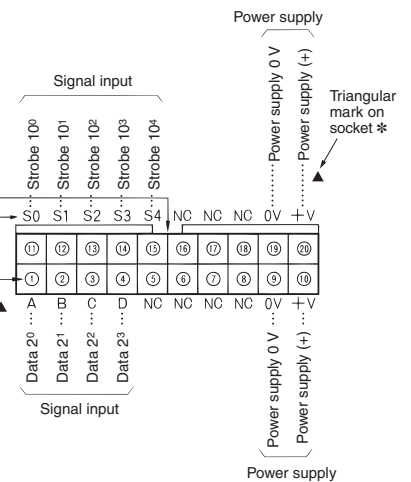

- Note:**
1. Circled numbers are for the user's convenience. When preparing a socket, pay attention when wiring the terminals to the direction of the polarity guide.
  2. The triangular mark (▲) on the M7F case indicates the start of the M7F terminal numbers. It does not line up with the triangular mark (▲) on the connector. Incorrect wiring may cause a short-circuit in the sequence output section, which could damage it.
- \* This is the location of the triangular mark on the XG4M-2030 Socket that is attached to the Cable.

## Terminal Functions

| Input method  | Terminal symbol            | Name                                       | Function  |   |
|---------------|----------------------------|--|---|---|
| Static input  | A1<br>B1<br>C1<br>D1       | First digit (10 <sup>0</sup> ) data input  | A1 (2 <sup>0</sup> )<br>B1 (2 <sup>1</sup> )<br>C1 (2 <sup>2</sup> )<br>D1 (2 <sup>3</sup> )                              | The numeral or symbol corresponding to the binary code signal will be displayed as the first digit (10 <sup>0</sup> ).  |
|               | A2<br>B2<br>C2<br>D2       | Second digit (10 <sup>1</sup> ) data input | A2 (2 <sup>0</sup> )<br>B2 (2 <sup>1</sup> )<br>C2 (2 <sup>2</sup> )<br>D2 (2 <sup>3</sup> )                              | The numeral or symbol corresponding to the binary code signal will be displayed as the second digit (10 <sup>1</sup> ). |
|               | A3<br>B3<br>C3<br>D3       | Third digit (10 <sup>2</sup> ) data input  | A3 (2 <sup>0</sup> )<br>B3 (2 <sup>1</sup> )<br>C3 (2 <sup>2</sup> )<br>D3 (2 <sup>3</sup> )                              | The numeral or symbol corresponding to the binary code signal will be displayed as the third digit (10 <sup>2</sup> ).  |
|               | A4<br>B4<br>C4<br>D4       | Fourth digit (10 <sup>3</sup> ) data input | A4 (2 <sup>0</sup> )<br>B4 (2 <sup>1</sup> )<br>C4 (2 <sup>2</sup> )<br>D4 (2 <sup>3</sup> )                              | The numeral or symbol corresponding to the binary code signal will be displayed as the fourth digit (10 <sup>3</sup> ). |
|               | +V                         | Power supply                               | Power supply and output terminal  |   |
|               | 0 V                        | Power supply                               | Power supply 0-V output terminal (GND)  |   |
| Dynamic input | A<br>B<br>C<br>D           | Data input                                 | A (2 <sup>0</sup> )<br>B (2 <sup>1</sup> )<br>C (2 <sup>2</sup> )<br>D (2 <sup>3</sup> )                                  | Displays the numeral or symbol corresponding to the binary code signal.   |
|               | S0<br>S1<br>S2<br>S3<br>S4 | Control input                              | S0 (10 <sup>0</sup> )<br>S1 (10 <sup>1</sup> )<br>S2 (10 <sup>2</sup> )<br>S3 (10 <sup>3</sup> )<br>S4 (10 <sup>4</sup> ) | Designates the digit to be displayed. Each digit will maintain the previous value when this signal is input.            |
|               | +V                         | Power supply                               | Power supply and output terminal  |   |
|               | 0 V                        | Power supply                               | Power supply 0-V output terminal (GND)  |   |

## DIP Switch Function

The DIP switch is used for symbol and decimal point settings. Refer to *Terminal Arrangement*, above, for details.

# Block Diagram

Note: Circled numbers are the connector pin numbers.

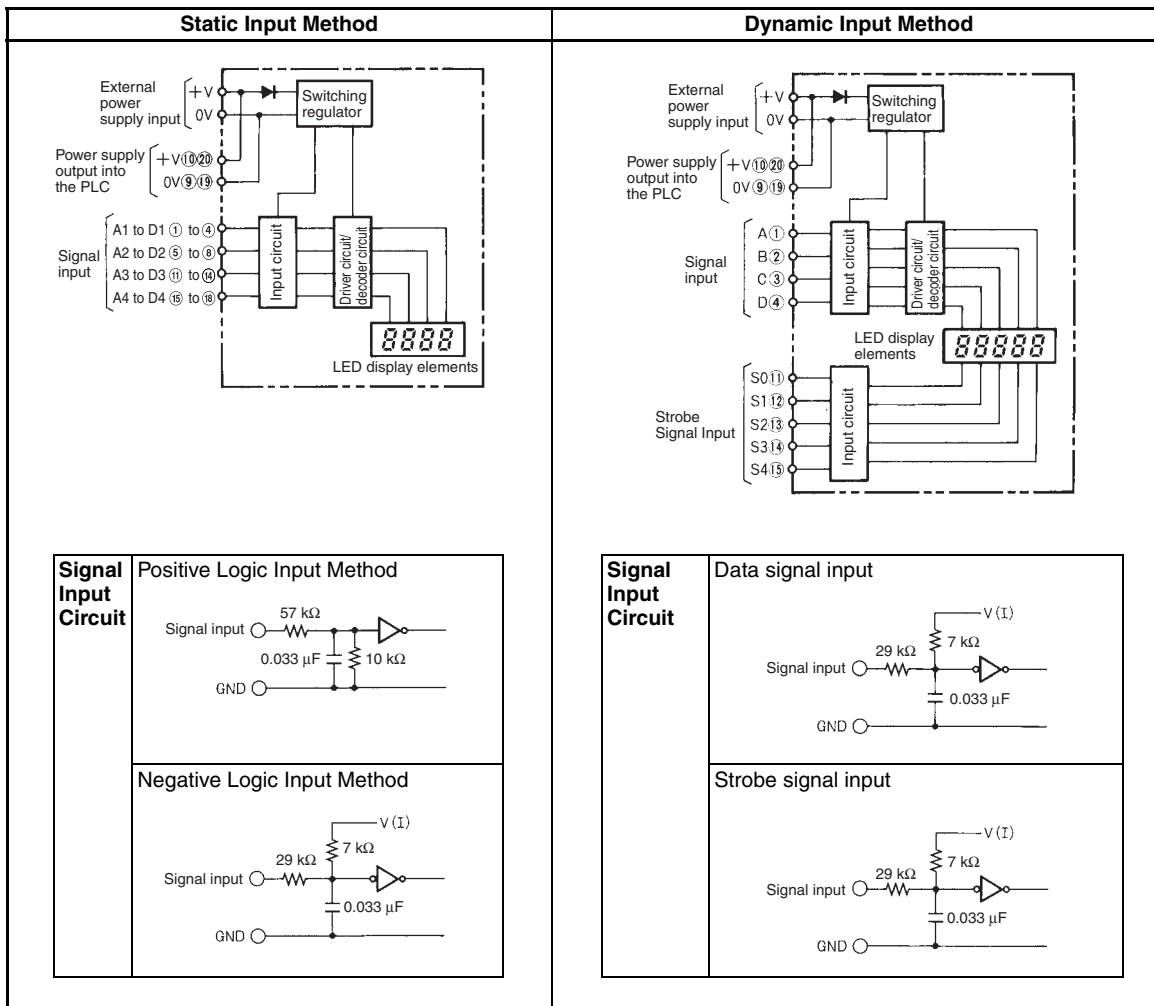



## External Connections

Refer to *Block Diagram* on page 8 and *Terminal Arrangement* on page 7 for external connections for the M7F according to the signal input method.

### PLC Connections

- Refer to your PLC operation manual before connecting the PLC.
- The M7F connects to the PLC without using any external resistor.
- It is necessary to select the correct input method of the M7F according to the output method of the PLC Output Unit. Refer to *Connectable PLCs* on page 2 for details on the selection of the correct input method.
- A PLC Dynamic Output Unit can be used to save wiring. Use a dynamic input model (M7F-□D□□□).

#### With PLC Static Output Unit

##### 1. M7F-□P□□□ Static Positive Logic Input Model

Connected to C500-OD212 Output Unit



#### Circuit Configuration



- Note:**
1. Use the M7F positive logic input model if the PLC Output Unit has PNP output.
  2. The PLC connects to the M7F with ease via the enclosed G79-Y□C Cable (with connectors, sold separately).

## 2. M7F-□N□□□ Static Negative Logic Input Model

### 1. Connected to C500-OD213 Output Unit



### Circuit Configuration



**Note:** The PLC connects to the M7F with ease via the G79-O□C-□ Cable (with connectors, sold separately).  
(The above example indicates 1 to 1 connection.)

### 2. Connected to C200H-OD215 Output Unit



### Circuit Configuration



**Note: 1.** If the C200H-OD215 is used as a Static Output Unit, the switches on the rear panel of the PLC must be set as described in the following table.

|                             |     |
|-----------------------------|-----|
| SW1 (static output mode)    | OFF |
| SW2                         | OFF |
| SW3                         | OFF |
| SW4                         | OFF |
| SW5 (negative logic output) | OFF |
| SW6                         | OFF |

Refer to your PLC operation manual for details.

2. A G79-□C Connecting Cable (with connectors, sold separately) can be used to easily connect the PLC to the M7F.

**With PLC Dynamic Output Unit**  
**M7F-□D□□□ Dynamic Input Model**

Connected to C200H-OD215 Output Unit

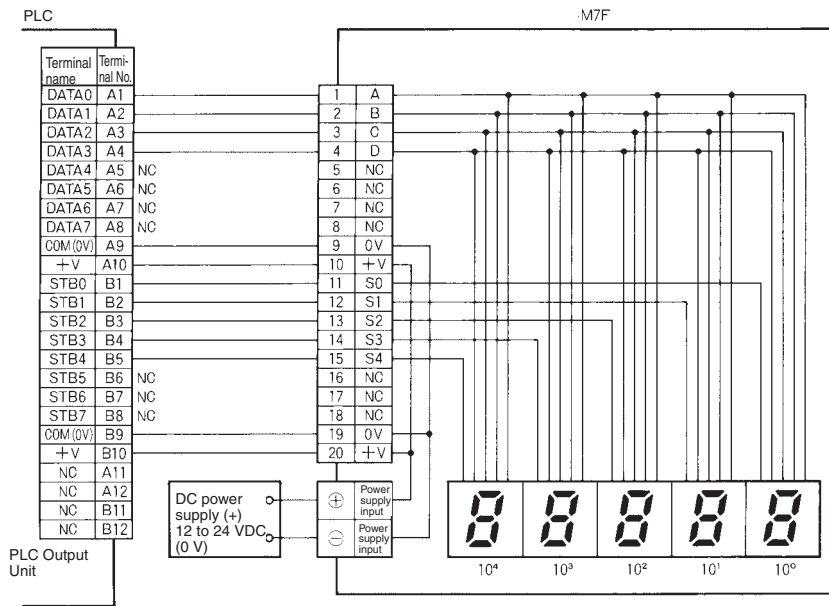

**Circuit Configuration**

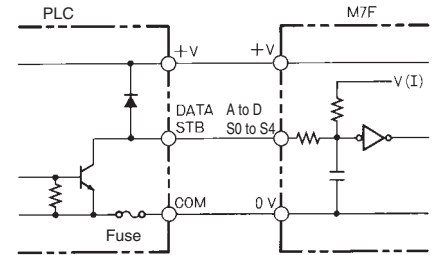

**Note: 1.** If the C200H-OD215 is used as a Dynamic Output Unit, the switches on the rear panel of the PLC must be set as described in the following table.

|                                    |     |
|------------------------------------|-----|
| <b>SW1 (dynamic output mode)</b>   | ON  |
| <b>SW2</b>                         | OFF |
| <b>SW3</b>                         | OFF |
| <b>SW4</b>                         | OFF |
| <b>SW5 (positive logic output)</b> | ON  |
| <b>SW6</b>                         | OFF |

Refer to your PLC operation manual for details.

2. A G79-□C Connecting Cable (with connectors, sold separately) can be used to easily connect the PLC to the M7F.

3. An eight-bit data signal is allocated to each strobe signal of the C200H-OD215 Dynamic Output Unit. On the other hand, each strobe signal is input only to the rightmost four bits of the M7F. Thus the following program must run.

**1. Status before PLC Program Runs (Data Storage Status)**

| Relay no.       | 15  | 14 | 13 | 12 | 11 | 10 | 09 | 08 | 07 | 06 | 05 | 04 | 03 | 02 | 01 | 00 |
|-----------------|-----|----|----|----|----|----|----|----|----|----|----|----|----|----|----|----|
| <b>Data no.</b> | 7   | 6  | 5  | 4  | 3  | 2  | 1  | 0  | 7  | 6  | 5  | 4  | 3  | 2  | 1  | 0  |
| <b>Word no.</b> | 005 | 4  |    |    | 3  |    |    | 2  |    |    | 1  |    |    | 0  |    |    |
|                 | 006 | /  |    |    | /  |    |    | /  |    |    | /  |    |    | 5  |    |    |
|                 | 007 | /  |    |    | /  |    |    | /  |    |    | /  |    |    | /  |    |    |
|                 | 008 | /  |    |    | /  |    |    | /  |    |    | /  |    |    | /  |    |    |

**Note:** Word numbers and data are examples.

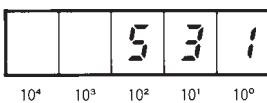

M7F's display

**2. Example of PLC Program Operation**

(Refer to your PLC operation manual for details.)

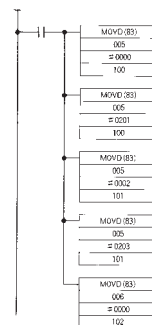

Transfers the first digit's data of word 005 to the first digit of word 100.

Transfers the second digit's data of word 005 to the third digit of word 100.

Transfers the third digit's data of word 005 to the first digit of word 101.

Transfers the fourth digit's data of word 005 to the third digit of word 101.

Transfers the first digit data of word 006 to the first digit of word 102.

**3. Status after PLC Program Has Run (Data Storage Status)**

| Relay no.       | 15  | 14 | 13 | 12 | 11 | 10 | 09 | 08 | 07 | 06 | 05 | 04 | 03 | 02 | 01 | 00 |
|-----------------|-----|----|----|----|----|----|----|----|----|----|----|----|----|----|----|----|
| <b>Data no.</b> | 7   | 6  | 5  | 4  | 3  | 2  | 1  | 0  | 7  | 6  | 5  | 4  | 3  | 2  | 1  | 0  |
| <b>Word no.</b> | 100 | /  |    |    | 2  |    |    | /  |    |    | 1  |    |    | /  |    |    |
|                 | 101 | /  |    |    | 4  |    |    | /  |    |    | 3  |    |    | /  |    |    |
|                 | 102 | /  |    |    | /  |    |    | /  |    |    | 5  |    |    | /  |    |    |
|                 | 103 | /  |    |    | /  |    |    | /  |    |    | /  |    |    | /  |    |    |

**Note:** Word numbers and data are examples.

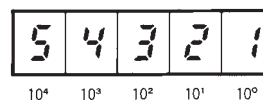

M7F's display

# Operation

## ■ Operation Timing (Input Signal Timing)

### Dynamic Input Method (M7F-□D□□□)

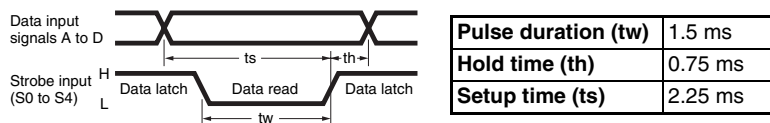

## ■ Operation Chart

### Dynamic Input Method (M7F-□D□□□)

The following example shows the relationship between each input terminal and the display condition. (Example: 5-digit)



# Dimensions

Note: All units are in millimeters unless otherwise indicated.

M7F-□□1□□

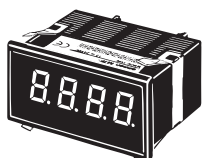

The M7F-4□1□ is illustrated.

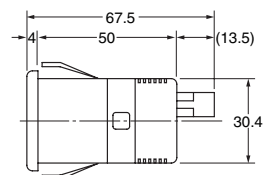
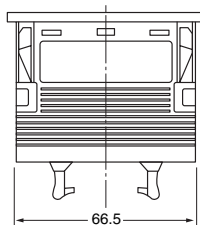
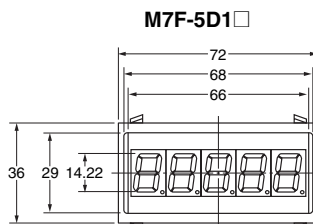
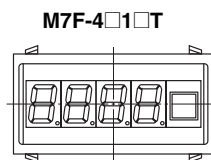
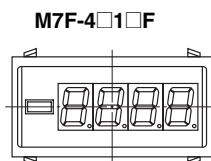
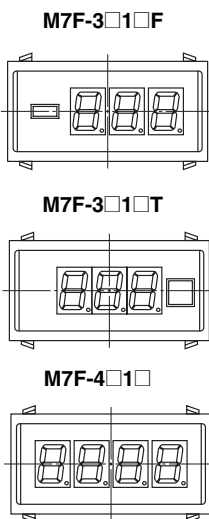
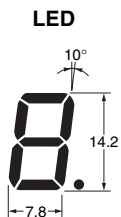

Panel Cutout  
(Single Mounting)

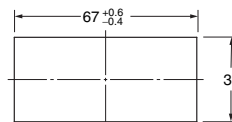

(Side-by-side Mounting)

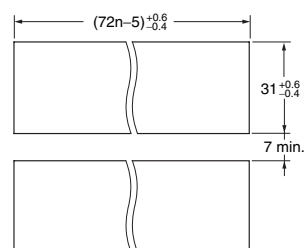

Panel thickness: 1 to 6 mm  
n: Number of Units mounted

# Safety Precautions

## CAUTION

Tighten the screws on the terminal block securely using the recommended tightening torque of 0.29 to 0.49 N·m. Loose screws may occasionally cause fire, resulting in minor or moderate injury, or damage to the equipment.



## Precautions for Safe Use

- Do not use or store the product in the following locations.
  - Locations subject to direct radiant heat from heating equipment
  - Locations where the product may come into contact with water, oil, or salt water
  - Locations subject to direct sunlight
  - Locations where dust or corrosive gases (in particular, sulfuric or ammonia gas) are present
  - Locations subject to extreme temperature changes
  - Locations where icing or condensation may occur
  - Locations subject to excessive shocks or vibration
  - Locations subject to temperatures or humidity outside the specified range
  - Locations outdoors or exposed to wind or rain
  - Locations subject to static electricity or noise
- Do not use the product in locations subject to temperatures outside the specified ranges or in locations subject to condensation. If the product is installed in a panel, be sure that the temperature around the product (not the temperature around the panel) does not go outside the specified range. The life of components is dependent on the temperature. The life of components shortens when the temperature rises, and it lengthens when the temperature falls. The life of components can be lengthened by lowering the temperature inside the product.
- Do not install the product near devices generating strong high frequency waves or surges. When using a noise filter, check the voltage and current and install it as close to the product as possible.
- Do not touch terminals or perform wiring while power is supplied to the product. Doing so may result in injury or malfunction.
- Do not touch the terminals while power is being supplied. Doing so may result in product failure or malfunction.
- When tightening the terminals or connecting connectors, support the product with one hand to prevent it from being pushed out of the front of the panel.
- Wire to the correct terminal number. Incorrect wiring may result in damage to or burning of components.
- Be sure power supplies and power lines for control power supply and inputs have appropriate specifications. Not using power supplies and power lines with appropriate specifications may result in malfunction, burning, or electric shock.
- Do not attempt to disassemble, repair, or modify the product. Doing so may occasionally result in minor or moderate injury.
- Do not allow pieces of metal, wire clippings, or fine metallic shavings or filings to enter the product. Doing so may occasionally result in fire or product failure.
- For DC input, use an SELV power supply with overcurrent protection. Specifically, use an SELV power supply with double or reinforced insulation between input and output, and an output voltage of 30 Vrms with 42.2 V peak or 60 VDC maximum. Recommended power supply: S8VS-06024□ (OMRON product)

## Precaution for Correct Use

### Wiring

- Do not tighten the power supply terminals with excessive force when wiring. Doing so may damage the terminals. Tighten each of them to a torque of 0.29 to 0.49 N·m.
- Do not impose excessive force on the rear panel when tightening the terminals of the M7F or connecting a connector to the M7F.
- When tightening the terminals of the M7F or connecting a connector to the M7F, hold the displays by hand, otherwise the displays may protrude from the case.

### Environment

When using the M7F in places with dust, metal powder, or sprayed oil, be sure to take appropriate measures so that no dust, metal powder, or sprayed oil will penetrate the interior of the Display Units.

### Mounting

- When panel-mounting, make sure that the side of the case marked "TOP" is upward.
- When panel-mounting, do not press the central part of the displays, otherwise the displays may be damaged. Press the flange part.

### Connections

- If power will be supplied to the M7F from the PLC's I/O service power supply, make sure that the current consumption of the M7F does not exceed the rated capacity of the service power supply.
- It is recommended to supply power to the M7F from a dedicated DC power supply in order to protect the PLC from being damaged.
- When using a controller other than the PLC or another company's PLC, be sure to check the terminal arrangement of the connector of the controller or the PLC. The terminal arrangement of OMRON's cables incorporating connectors corresponds to that of the PLC.

### Removing Color Plate

There is a gap (with a width of approximately 1 mm) between the case and color plate on the left and right sides. To remove the color plate, insert a flat-blade screwdriver into either one of the gaps and move the color plate upwards.



### Replacing Unit Plate

- Remove the unit plate with a pair of tweezers.
- Before pasting a unit plate to the plate holder, remove the ground paper from the unit plate. Paste the unit plate to the plate holder so that the symbol mark or character(s) of the face plate will be on the bottom side (i.e., the decimal-point side) of the M7F.



## Attaching Color Plate

Insert the projecting parts of the color plate into the square holes of the case to attach the color plate to the case.

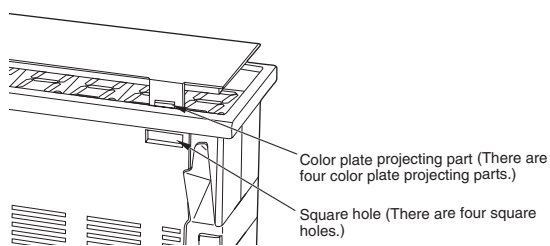

## DIP Switch Settings

The DIP switch can be set with the tip of a ball-point pen or small screwdriver. Do not use anything that has a sharp edge (e.g., tweezers) to set the DIP switch.

ALL DIMENSIONS SHOWN ARE IN MILLIMETERS.

To convert millimeters into inches, multiply by 0.03937. To convert grams into ounces, multiply by 0.03527.

In the interest of product improvement, specifications are subject to change without notice.

## Read and Understand This Catalog

Please read and understand this catalog before purchasing the products. Please consult your OMRON representative if you have any questions or comments.

## Warranty and Limitations of Liability

### WARRANTY

OMRON's exclusive warranty is that the products are free from defects in materials and workmanship for a period of one year (or other period if specified) from date of sale by OMRON.

OMRON MAKES NO WARRANTY OR REPRESENTATION, EXPRESS OR IMPLIED, REGARDING NON-INFRINGEMENT, MERCHANTABILITY, OR FITNESS FOR PARTICULAR PURPOSE OF THE PRODUCTS. ANY BUYER OR USER ACKNOWLEDGES THAT THE BUYER OR USER ALONE HAS DETERMINED THAT THE PRODUCTS WILL SUITABLY MEET THE REQUIREMENTS OF THEIR INTENDED USE. OMRON DISCLAIMS ALL OTHER WARRANTIES, EXPRESS OR IMPLIED.

### LIMITATIONS OF LIABILITY

OMRON SHALL NOT BE RESPONSIBLE FOR SPECIAL, INDIRECT, OR CONSEQUENTIAL DAMAGES, LOSS OF PROFITS OR COMMERCIAL LOSS IN ANY WAY CONNECTED WITH THE PRODUCTS, WHETHER SUCH CLAIM IS BASED ON CONTRACT, WARRANTY, NEGLIGENCE, OR STRICT LIABILITY.

In no event shall the responsibility of OMRON for any act exceed the individual price of the product on which liability is asserted.

IN NO EVENT SHALL OMRON BE RESPONSIBLE FOR WARRANTY, REPAIR, OR OTHER CLAIMS REGARDING THE PRODUCTS UNLESS OMRON'S ANALYSIS CONFIRMS THAT THE PRODUCTS WERE PROPERLY HANDLED, STORED, INSTALLED, AND MAINTAINED AND NOT SUBJECT TO CONTAMINATION, ABUSE, MISUSE, OR INAPPROPRIATE MODIFICATION OR REPAIR.

## Application Considerations

### SUITABILITY FOR USE

OMRON shall not be responsible for conformity with any standards, codes, or regulations that apply to the combination of products in the customer's application or use of the products.

At the customer's request, OMRON will provide applicable third party certification documents identifying ratings and limitations of use that apply to the products. This information by itself is not sufficient for a complete determination of the suitability of the products in combination with the end product, machine, system, or other application or use.

The following are some examples of applications for which particular attention must be given. This is not intended to be an exhaustive list of all possible uses of the products, nor is it intended to imply that the uses listed may be suitable for the products:

- Outdoor use, uses involving potential chemical contamination or electrical interference, or conditions or uses not described in this catalog.
- Nuclear energy control systems, combustion systems, railroad systems, aviation systems, medical equipment, amusement machines, vehicles, safety equipment, and installations subject to separate industry or government regulations.
- Systems, machines, and equipment that could present a risk to life or property.

Please know and observe all prohibitions of use applicable to the products.

NEVER USE THE PRODUCTS FOR AN APPLICATION INVOLVING SERIOUS RISK TO LIFE OR PROPERTY WITHOUT ENSURING THAT THE SYSTEM AS A WHOLE HAS BEEN DESIGNED TO ADDRESS THE RISKS, AND THAT THE OMRON PRODUCTS ARE PROPERLY RATED AND INSTALLED FOR THE INTENDED USE WITHIN THE OVERALL EQUIPMENT OR SYSTEM.

### PROGRAMMABLE PRODUCTS

OMRON shall not be responsible for the user's programming of a programmable product, or any consequence thereof.

## Disclaimers

### CHANGE IN SPECIFICATIONS

Product specifications and accessories may be changed at any time based on improvements and other reasons.

It is our practice to change model numbers when published ratings or features are changed, or when significant construction changes are made. However, some specifications of the products may be changed without any notice. When in doubt, special model numbers may be assigned to fix or establish key specifications for your application on your request. Please consult with your OMRON representative at any time to confirm actual specifications of purchased products.

### DIMENSIONS AND WEIGHTS

Dimensions and weights are nominal and are not to be used for manufacturing purposes, even when tolerances are shown.

### PERFORMANCE DATA

Performance data given in this catalog is provided as a guide for the user in determining suitability and does not constitute a warranty. It may represent the result of OMRON's test conditions, and the users must correlate it to actual application requirements. Actual performance is subject to the OMRON Warranty and Limitations of Liability.

### ERRORS AND OMISSIONS

The information in this document has been carefully checked and is believed to be accurate; however, no responsibility is assumed for clerical, typographical, or proofreading errors, or omissions.

2011.12

In the interest of product improvement, specifications are subject to change without notice.

**OMRON Corporation**  
Industrial Automation Company

<http://www.ia.omron.com/>

(c)Copyright OMRON Corporation 2011 All Right Reserved.



# Mouser Electronics

Authorized Distributor

Click to View Pricing, Inventory, Delivery & Lifecycle Information:

Omron:

[M7F-4N1G](#) [M7F-4N1R](#) [M7F-4P1R](#) [M7F-5D1R](#) [M7F-4D1G](#) [M7F-4P1G](#) [M7F-3N1GT](#) [M7F-3N1RT](#) [M7F-4D1R](#)  
[M7F-3P1RT](#) [M7F-4D1RT](#)

## Данный компонент на территории Российской Федерации

### Вы можете приобрести в компании MosChip.

Для оперативного оформления запроса Вам необходимо перейти по данной ссылке:

<http://moschip.ru/get-element>

Вы можете разместить у нас заказ для любого Вашего проекта, будь то серийное производство или разработка единичного прибора.

В нашем ассортименте представлены ведущие мировые производители активных и пассивных электронных компонентов.

Нашей специализацией является поставка электронной компонентной базы двойного назначения, продукции таких производителей как XILINX, Intel (ex.ALTERA), Vicor, Microchip, Texas Instruments, Analog Devices, Mini-Circuits, Amphenol, Glenair.

Сотрудничество с глобальными дистрибьюторами электронных компонентов, предоставляет возможность заказывать и получать с международных складов практически любой перечень компонентов в оптимальные для Вас сроки.

На всех этапах разработки и производства наши партнеры могут получить квалифицированную поддержку опытных инженеров.

Система менеджмента качества компании отвечает требованиям в соответствии с ГОСТ Р ИСО 9001, ГОСТ РВ 0015-002 и ЭС РД 009

### Офис по работе с юридическими лицами:

105318, г.Москва, ул.Щербаковская д.3, офис 1107, 1118, ДЦ «Щербаковский»

Телефон: +7 495 668-12-70 (многоканальный)

Факс: +7 495 668-12-70 (доб.304)

E-mail: [info@moschip.ru](mailto:info@moschip.ru)

Skype отдела продаж:

moschip.ru

moschip.ru\_4

moschip.ru\_6

moschip.ru\_9