

High Speed PT IGBT

POWER MOS 8® is a high speed Punch-Through switch-mode IGBT. Low E_{off} is achieved through leading technology silicon design and lifetime control processes. A reduced $E_{off} - V_{CE(ON)}$ tradeoff results in superior efficiency compared to other IGBT technologies. Low gate charge and a greatly reduced ratio of C_{res}/C_{ies} provide excellent noise immunity, short delay times and simple gate drive. The intrinsic chip gate resistance and capacitance of the poly-silicone gate structure help control di/dt during switching, resulting in low EMI, even when switching at high frequency.

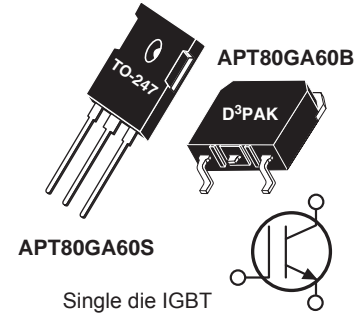

FEATURES

- Fast switching with low EMI
- Very Low E_{off} for maximum efficiency
- Ultra low C_{res} for improved noise immunity
- Low conduction loss
- Low gate charge
- Increased intrinsic gate resistance for low EMI
- RoHS compliant 

TYPICAL APPLICATIONS

- ZVS phase shifted and other full bridge
- Half bridge
- High power PFC boost
- Welding
- UPS, solar, and other inverters
- High frequency, high efficiency industrial

Absolute Maximum Ratings

| Symbol | Parameter | Ratings | Unit |
|----------------|---|-------------|------|
| V_{CES} | Collector Emitter Voltage | 600 | V |
| I_{C1} | Continuous Collector Current @ $T_c = 25^\circ\text{C}$ | 143 | A |
| I_{C2} | Continuous Collector Current @ $T_c = 100^\circ\text{C}$ | 80 | |
| I_{CM} | Pulsed Collector Current ¹ | 240 | |
| V_{GE} | Gate-Emitter Voltage ² | ± 30 | V |
| P_D | Total Power Dissipation @ $T_c = 25^\circ\text{C}$ | 625 | W |
| SSOA | Switching Safe Operating Area @ $T_j = 150^\circ\text{C}$ | 240A @ 600V | |
| T_j, T_{STG} | Operating and Storage Junction Temperature Range | -55 to 150 | °C |
| T_L | Lead Temperature for Soldering: 0.063" from Case for 10 Seconds | 300 | |

Static Characteristics

$T_j = 25^\circ\text{C}$ unless otherwise specified

| Symbol | Parameter | Test Conditions | Min | Typ | Max | Unit |
|---------------|-------------------------------------|---|-----|------------|-------------|---------------|
| $V_{BR(CES)}$ | Collector-Emitter Breakdown Voltage | $V_{GE} = 0V, I_C = 1.0mA$ | 600 | | | V |
| $V_{CE(on)}$ | Collector-Emitter On Voltage | $V_{GE} = 15V, I_C = 47A$ $T_j = 25^\circ\text{C}$ $T_j = 125^\circ\text{C}$ | | 2.0 1.9 | 2.5 | |
| $V_{GE(th)}$ | Gate Emitter Threshold Voltage | $V_{GE} = V_{CE}, I_C = 1mA$ | 3 | 4.5 | 6 | |
| I_{CES} | Zero Gate Voltage Collector Current | $V_{CE} = 600V, V_{GE} = 0V$ $T_j = 25^\circ\text{C}$ $T_j = 125^\circ\text{C}$ | | | 250 1000 | μA |
| I_{GES} | Gate-Emitter Leakage Current | $V_{GS} = \pm 30V$ | | | ± 100 | nA |

Thermal and Mechanical Characteristics

| Symbol | Characteristic | Min | Typ | Max | Unit |
|-----------------|--|-----|-----|-----|--------|
| $R_{\theta JC}$ | Junction to Case Thermal Resistance | - | - | 0.2 | °C/W |
| W_T | Package Weight | - | 5.9 | - | g |
| Torque | Mounting Torque (TO-247 Package), 4-40 or M3 screw | | | 10 | in-lbf |

Dynamic Characteristics

T_J = 25°C unless otherwise specified

APT80GA60B_S

| Symbol | Parameter | Test Conditions | Min | Typ | Max | Unit |
|-------------------------------|-------------------------------|---|------|------|-----|------|
| C _{ies} | Input Capacitance | Capacitance V _{GE} = 0V, V _{CE} = 25V f = 1MHz | | 6390 | | pF |
| C _{oes} | Output Capacitance | | | 580 | | |
| C _{res} | Reverse Transfer Capacitance | | | 63 | | |
| Q _g ³ | Total Gate Charge | Gate Charge V _{GE} = 15V V _{CE} = 300V I _C = 47A | | 230 | | nC |
| Q _{ge} | Gate-Emitter Charge | | | 40 | | |
| Q _{gc} | Gate- Collector Charge | | | 78 | | |
| SSOA | Switching Safe Operating Area | T _J = 150°C, R _G = 4.7Ω ⁴ , V _{GE} = 15V, L = 100uH, V _{CE} = 600V | 240 | | | A |
| t _{d(on)} | Turn-On Delay Time | Inductive Switching (25°C) V _{CC} = 400V V _{GE} = 15V I _C = 47A R _G = 4.7Ω ⁴ T _J = +25°C | | 23 | | ns |
| t _r | Current Rise Time | | | 27 | | |
| t _{d(off)} | Turn-Off Delay Time | | | 158 | | |
| t _f | Current Fall Time | | | 78 | | |
| E _{on2} | Turn-On Switching Energy | | | 840 | | |
| E _{off} ⁶ | Turn-Off Switching Energy | | 751 | | μJ | |
| t _{d(on)} | Turn-On Delay Time | Inductive Switching (125°C) V _{CC} = 400V V _{GE} = 15V I _C = 47A R _G = 4.7Ω ⁴ T _J = +125°C | | 21 | | ns |
| t _r | Current Rise Time | | | 31 | | |
| t _{d(off)} | Turn-Off Delay Time | | | 194 | | |
| t _f | Current Fall Time | | | 132 | | |
| E _{on2} | Turn-On Switching Energy | | | 1275 | | |
| E _{off} ⁶ | Turn-Off Switching Energy | | 1112 | | μJ | |

1 Repetitive Rating: Pulse width and case temperature limited by maximum junction temperature.

2 Pulse test: Pulse Width < 380μs, duty cycle < 2%.

3 See Mil-Std-750 Method 3471.

4 R_G is external gate resistance, not including internal gate resistance or gate driver impedance. (MIC4452)

5 E_{on2} is the clamped inductive turn on energy that includes a commutating diode reverse recovery current in the IGBT turn on energy loss. A combi device is used for the clamping diode.

6 E_{off} is the clamped inductive turn-off energy measured in accordance with JEDEC standard JESD24-1.

Microsemi reserves the right to change, without notice, the specifications and information contained herein.

Typical Performance Curves

APT80GA60B_S

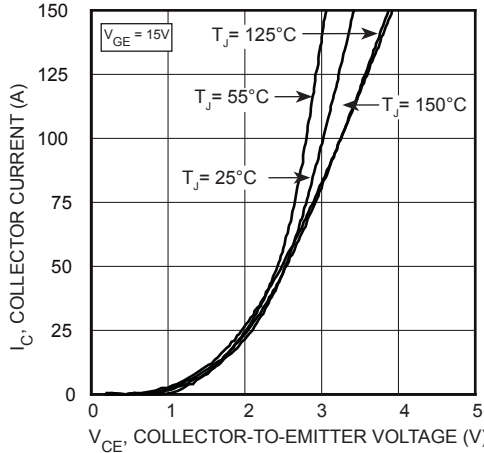

FIGURE 1, Output Characteristics ($T_J = 25^\circ\text{C}$)

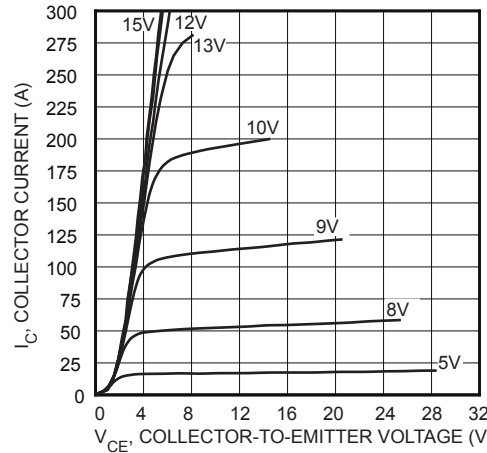

FIGURE 2, Output Characteristics ($T_J = 25^\circ\text{C}$)

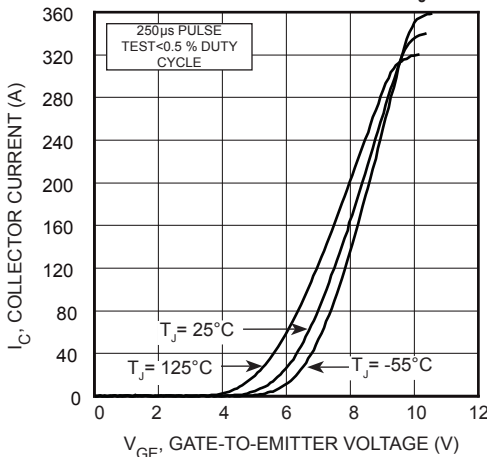

FIGURE 3, Transfer Characteristics

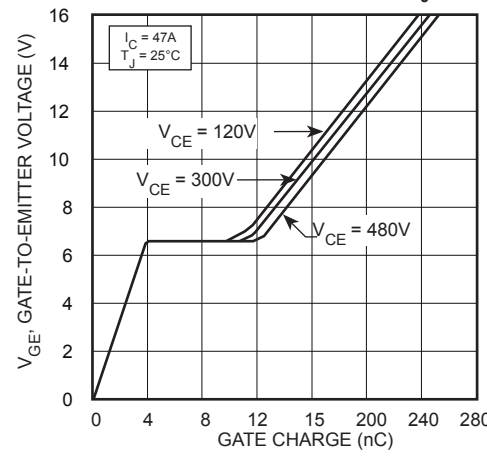

FIGURE 4, Gate charge

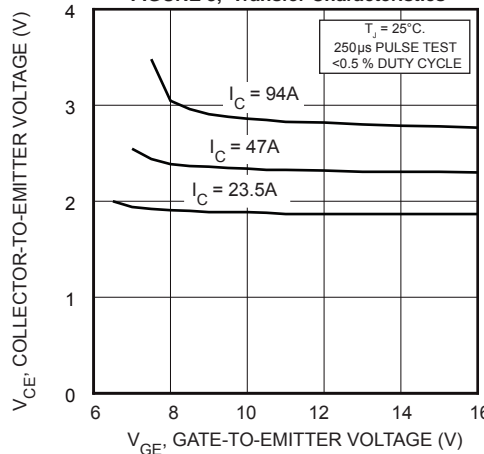

FIGURE 5, On State Voltage vs Gate-to-Emitter Voltage

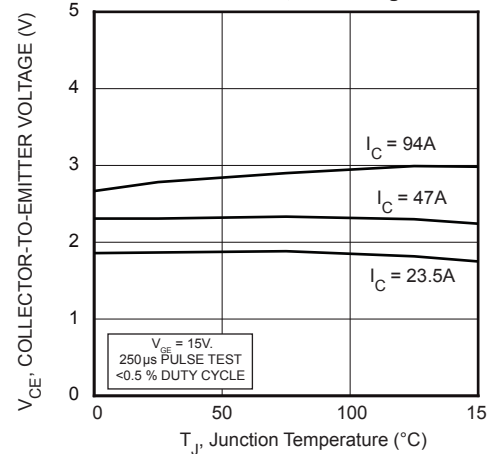

FIGURE 6, On State Voltage vs Junction Temperature

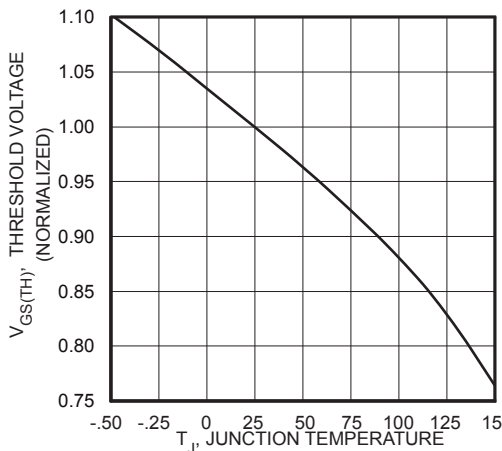

FIGURE 7, Threshold Voltage vs Junction Temperature

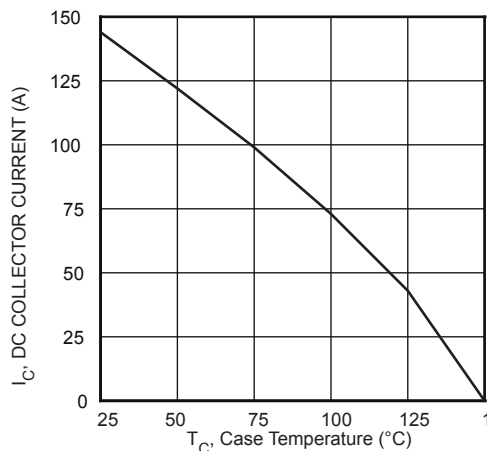

FIGURE 8, DC Collector Current vs Case Temperature

Typical Performance Curves

APT80GA60B_S

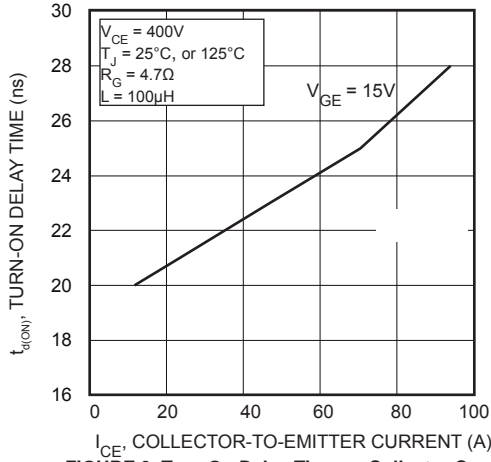

FIGURE 9, Turn-On Delay Time vs Collector Current

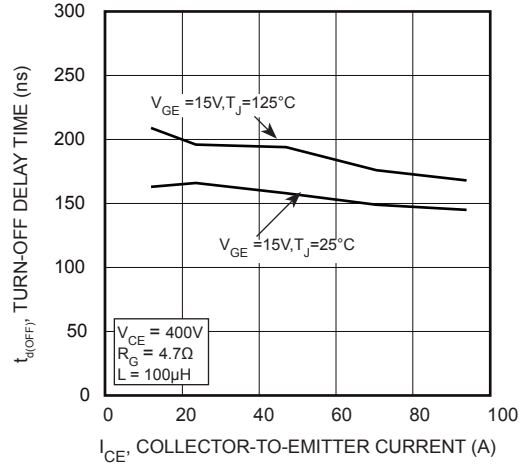

FIGURE 10, Turn-Off Delay Time vs Collector Current

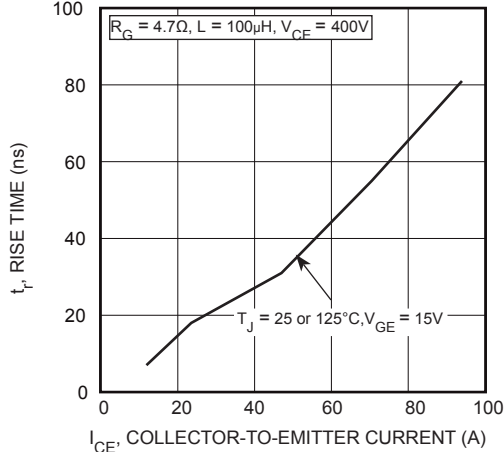

FIGURE 11, Current Rise Time vs Collector Current

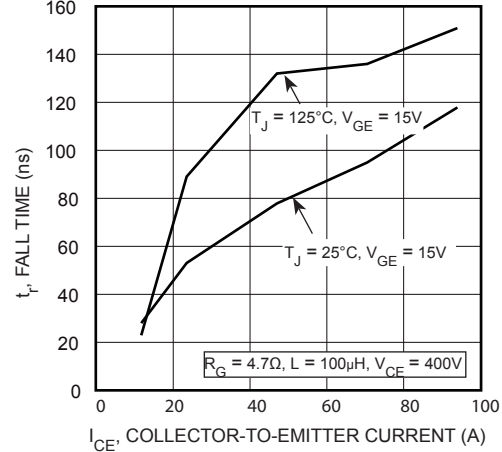

FIGURE 12, Current Fall Time vs Collector Current

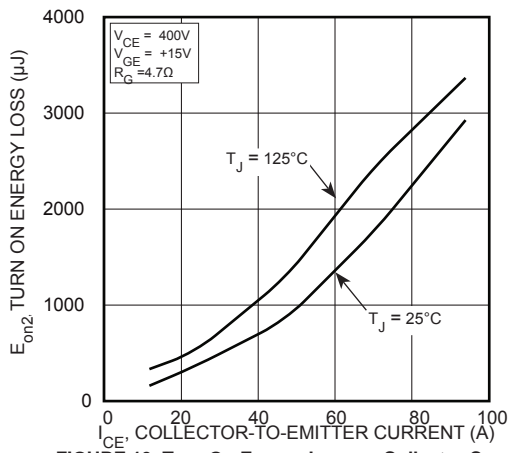

FIGURE 13, Turn-On Energy Loss vs Collector Current

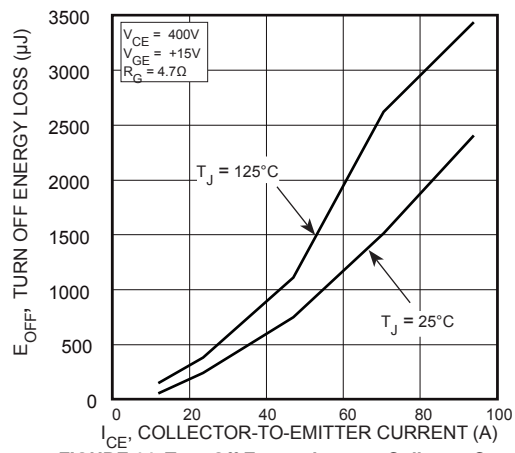

FIGURE 14, Turn-Off Energy Loss vs Collector Current

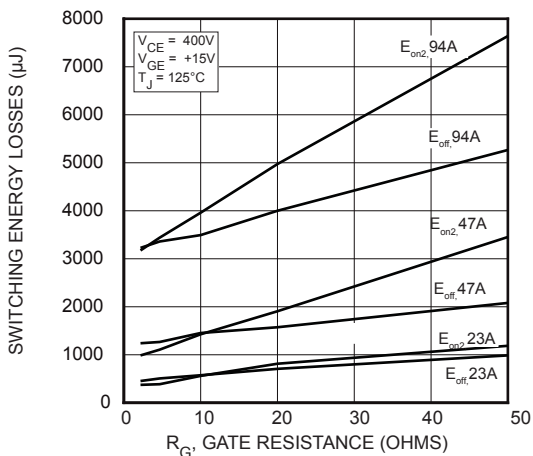

FIGURE 15, Switching Energy Losses vs Gate Resistance

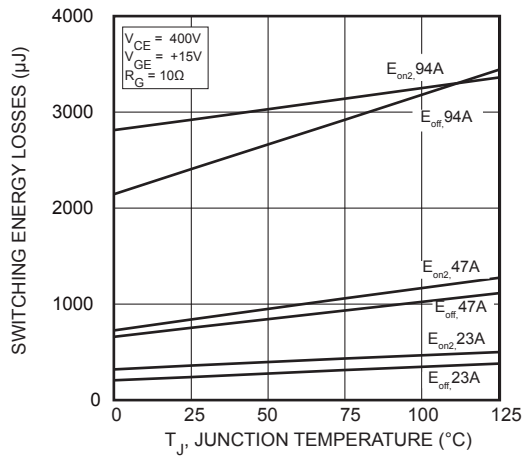

FIGURE 16, Switching Energy Losses vs Junction Temperature

Typical Performance Curves

APT80GA60B_S

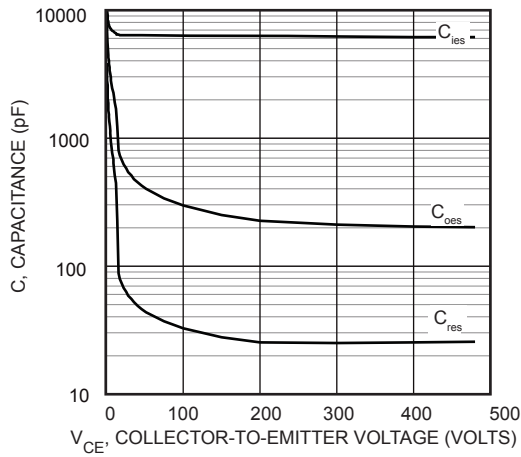

FIGURE 17, Capacitance vs Collector-To-Emitter Voltage

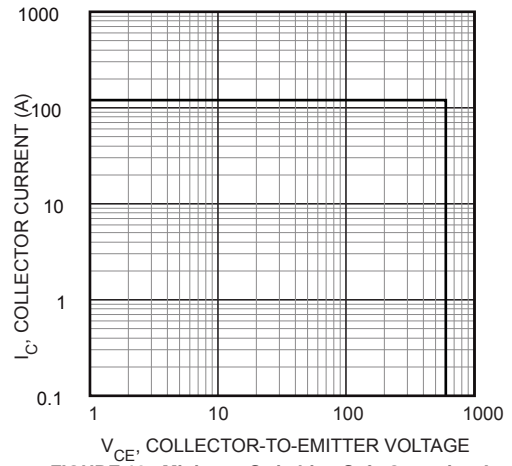

FIGURE 18, Minimum Switching Safe Operating Area

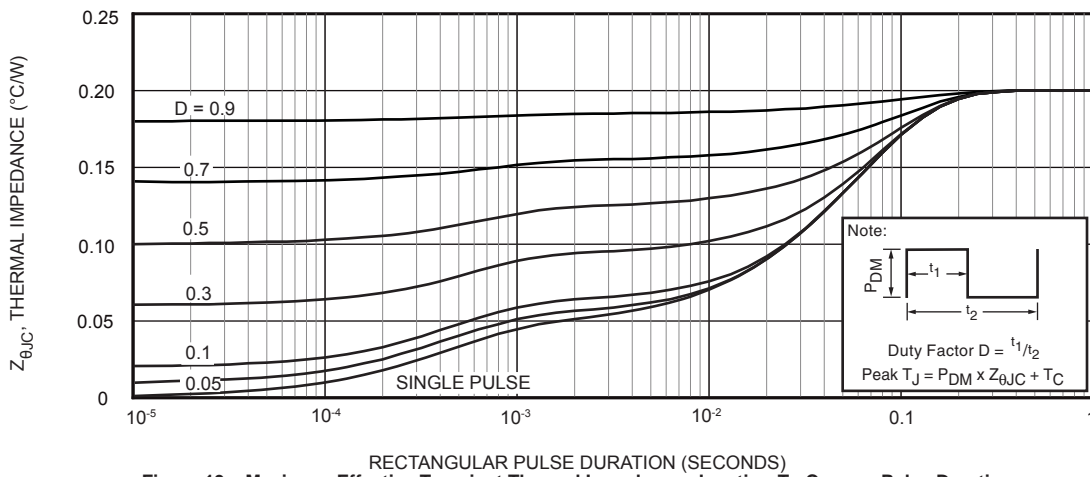

Figure 19a, Maximum Effective Transient Thermal Impedance, Junction-To-Case vs Pulse Duration

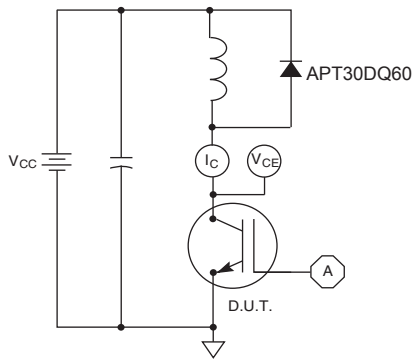

Figure 20, Inductive Switching Test Circuit

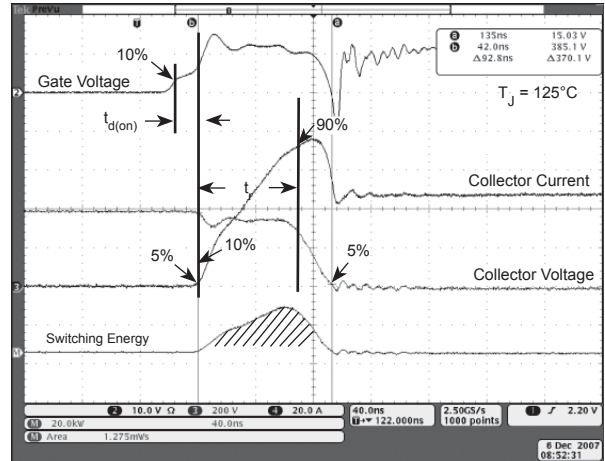

Figure 21, Turn-on Switching Waveforms and Definitions

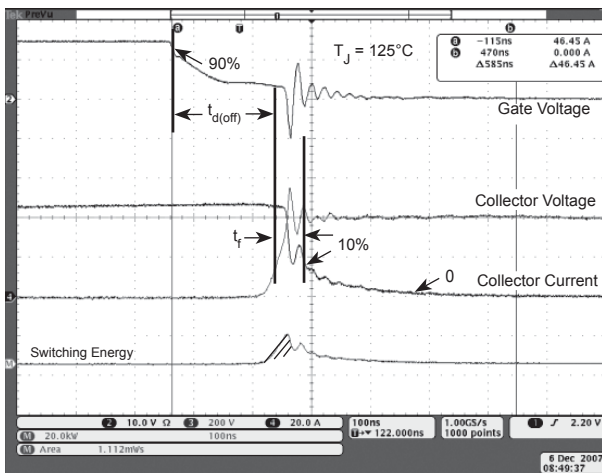
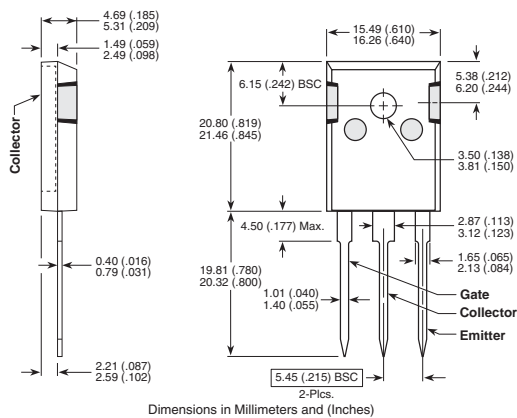

Figure 22, Turn-off Switching Waveforms and Definitions

TO-247 (B) Package Outline



D³PAK Package Outline

e3 100% Sn Plated

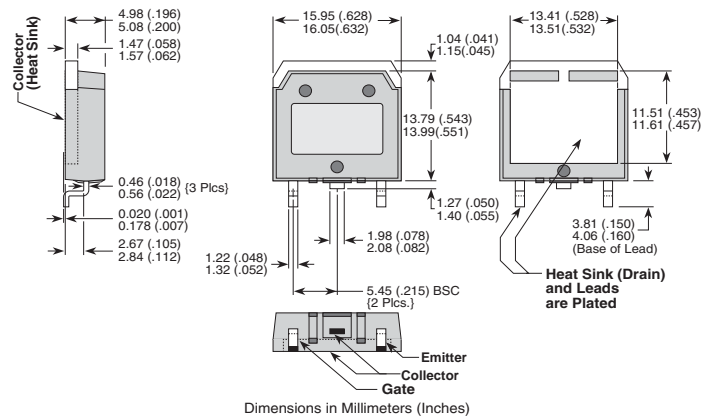

Microsemi's products are covered by one or more of U.S. patents 4,895,810 5,045,903 5,089,434 5,182,234 5,019,522 5,262,336 6,503,786 5,256,583 4,748,103 5,283,202 5,231,474 5,434,095 5,528,058 6,939,743, 7,352,045 5,283,201 5,801,417 5,648,283 7,196,634 6,664,594 7,157,886 6,939,743 7,342,262 and foreign patents. US and Foreign patents pending. All Rights Reserved.

Данный компонент на территории Российской Федерации

Вы можете приобрести в компании MosChip.

Для оперативного оформления запроса Вам необходимо перейти по данной ссылке:

<http://moschip.ru/get-element>

Вы можете разместить у нас заказ для любого Вашего проекта, будь то серийное производство или разработка единичного прибора.

В нашем ассортименте представлены ведущие мировые производители активных и пассивных электронных компонентов.

Нашей специализацией является поставка электронной компонентной базы двойного назначения, продукции таких производителей как XILINX, Intel (ex.ALTERA), Vicor, Microchip, Texas Instruments, Analog Devices, Mini-Circuits, Amphenol, Glenair.

Сотрудничество с глобальными дистрибьюторами электронных компонентов, предоставляет возможность заказывать и получать с международных складов практически любой перечень компонентов в оптимальные для Вас сроки.

На всех этапах разработки и производства наши партнеры могут получить квалифицированную поддержку опытных инженеров.

Система менеджмента качества компании отвечает требованиям в соответствии с ГОСТ Р ИСО 9001, ГОСТ РВ 0015-002 и ЭС РД 009

Офис по работе с юридическими лицами:

105318, г.Москва, ул.Щербаковская д.3, офис 1107, 1118, ДЦ «Щербаковский»

Телефон: +7 495 668-12-70 (многоканальный)

Факс: +7 495 668-12-70 (доб.304)

E-mail: info@moschip.ru

Skype отдела продаж:

moschip.ru

moschip.ru_4

moschip.ru_6

moschip.ru_9